



US00D848549S

(12) **United States Design Patent** (10) **Patent No.:** **US D848,549 S**
Cummings et al. (45) **Date of Patent:** **** May 14, 2019**

(54) **POSABLE TOY DOG**

(71) Applicant: **KMA Concepts Limited**, Tsim Sha Tsui, Kowloon (HK)

(72) Inventors: **Peter John Cummings**, Kowloon (HK); **Chun Kit Ng**, Kowloon (HK)

(73) Assignee: **KMA Concepts Limited**, North Point (HK)

(**) Term: **15 Years**

(21) Appl. No.: **29/621,351**

(22) Filed: **Oct. 6, 2017**

(51) **LOC (11) Cl.** **21-01**

(52) **U.S. Cl.**
 USPC **D21/611; D21/578**

(58) **Field of Classification Search**
 USPC D6/598; D11/158, 162; D21/576–595, D21/611–613; 446/368–369, 376, 428, 446/487; 180/8.6; D30/160
 CPC ... A63H 3/00; A63H 3/02; A63H 3/04; A63H 3/16; A63H 3/28; A63H 33/00; A63H 7/06; A63H 11/00; A63H 11/10; A63H 11/20; A63H 13/00
 See application file for complete search history.

(56) **References Cited**

U.S. PATENT DOCUMENTS

D418,551 S *	1/2000	Kageyama	D21/611
D431,270 S *	9/2000	Kawakita	D21/611
D445,849 S *	7/2001	Saito	D21/578
D448,433 S *	9/2001	Ueda	D21/578
D457,203 S *	5/2002	Onishi	D21/578

D457,205 S *	5/2002	Hornsby	D21/578
6,458,011 B1 *	10/2002	Inoue	A63H 3/006 446/376
D467,630 S *	12/2002	Kawakita	G05D 1/0246 D21/578
D467,983 S *	12/2002	Yamazaki	D21/611
D468,374 S *	1/2003	So	D21/611
D468,375 S *	1/2003	So	D21/611
6,952,629 B2 *	10/2005	Takamura	G05D 1/0246 250/208.1
D511,188 S *	11/2005	Takeda	A63H 3/006 D21/611
D531,681 S *	11/2006	Larian	D21/576
D566,794 S *	4/2008	Judkins	D21/611
D566,795 S *	4/2008	Judkins	D21/611
D667,510 S *	9/2012	Hayakawa	D21/611
D760,851 S *	7/2016	Cummings	D21/578
D778,372 S *	2/2017	Cummings	D21/578

* cited by examiner

Primary Examiner — Sandra L Morris

(74) *Attorney, Agent, or Firm* — LaMorte & Associates, P.C.

(57) **CLAIM**

The ornamental design for a posable toy dog, as shown and described.

DESCRIPTION

FIG. 1 is a perspective view of a posable toy dog;
 FIG. 2 is a front view thereof;
 FIG. 3 is a rear view thereof;
 FIG. 4 is a right side view thereof;
 FIG. 5 is a left side view thereof;
 FIG. 6 is a top view thereof; and,
 FIG. 7 is a bottom view thereof.

1 Claim, 7 Drawing Sheets

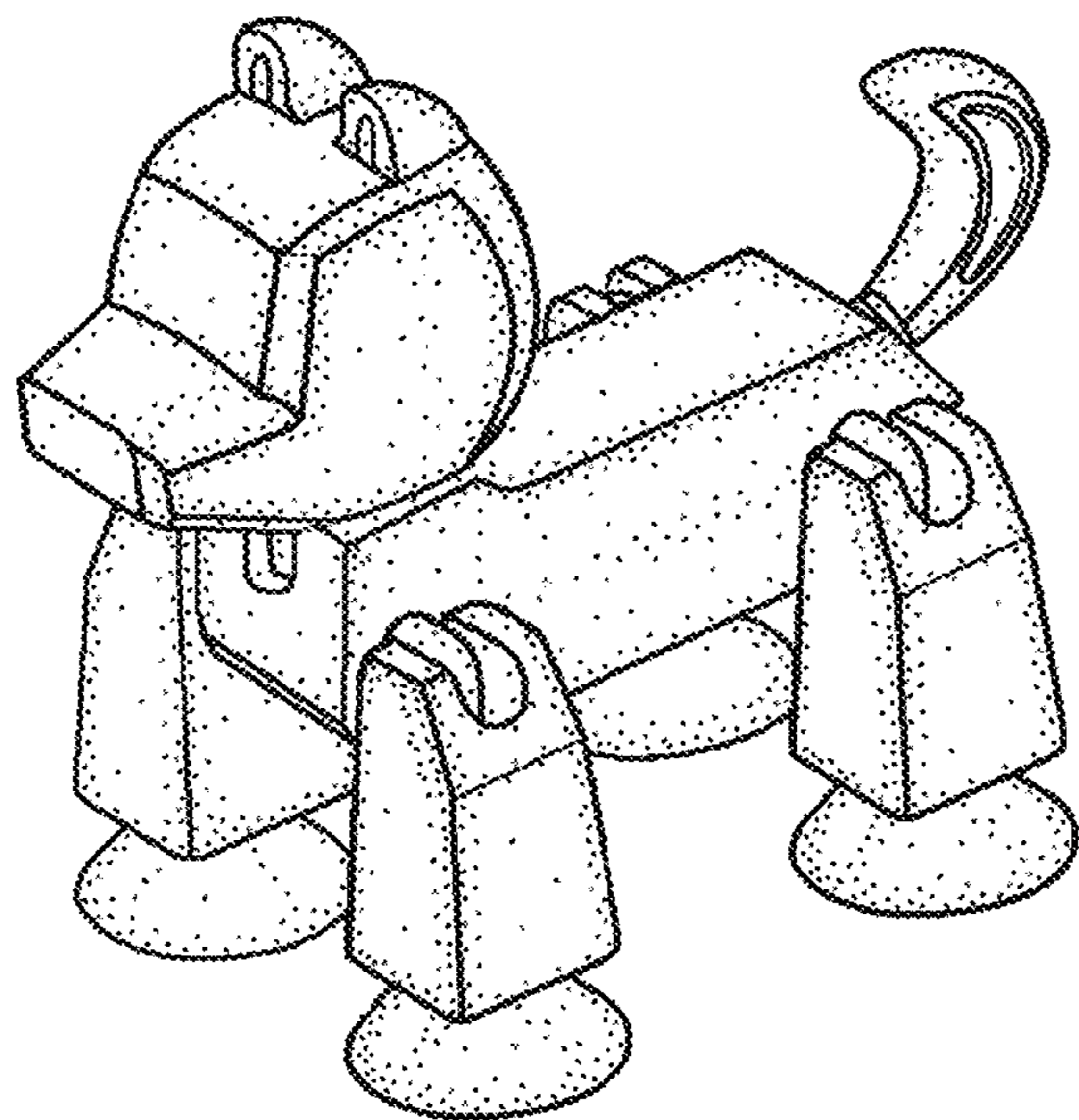

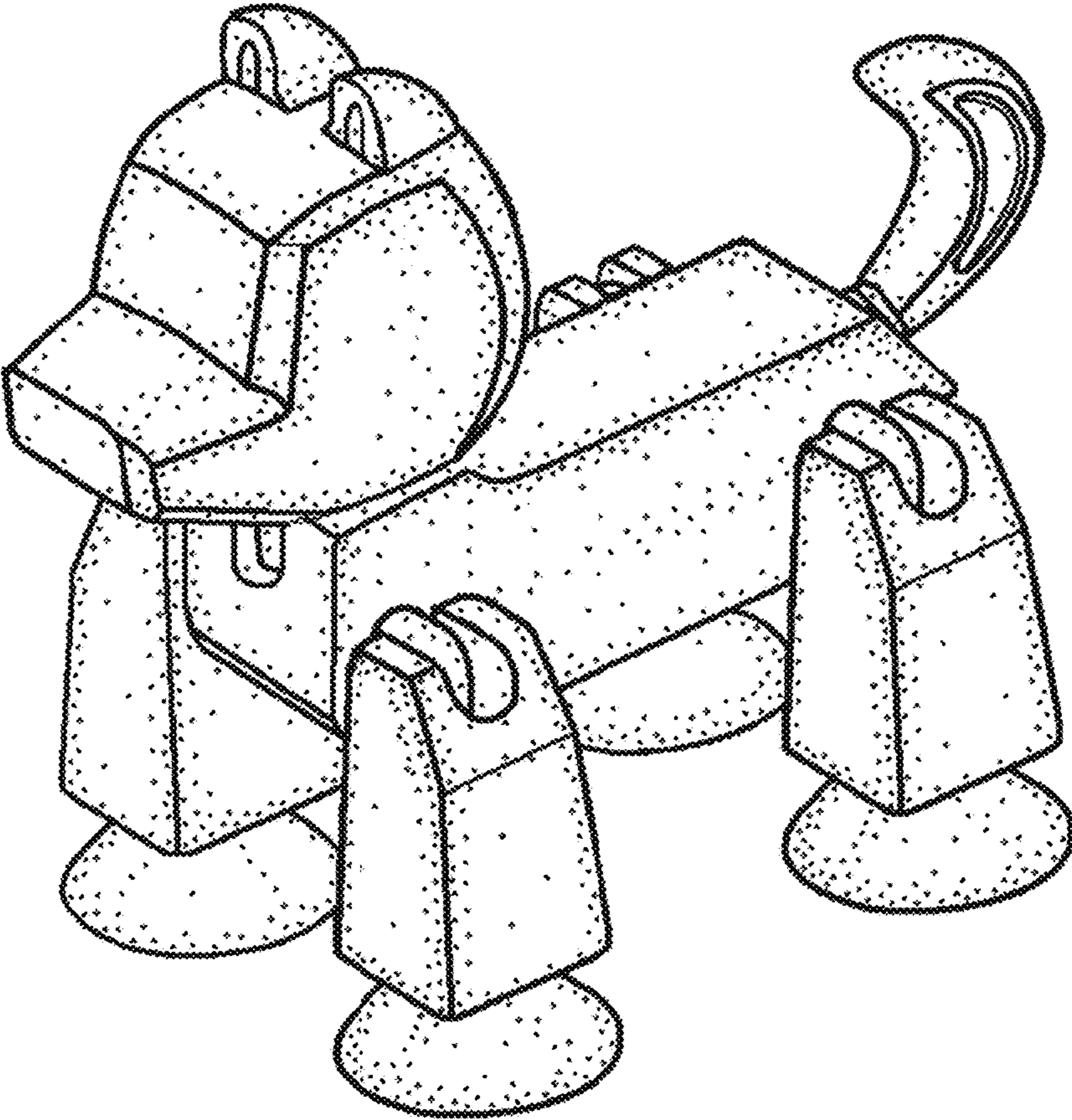

FIG. 1

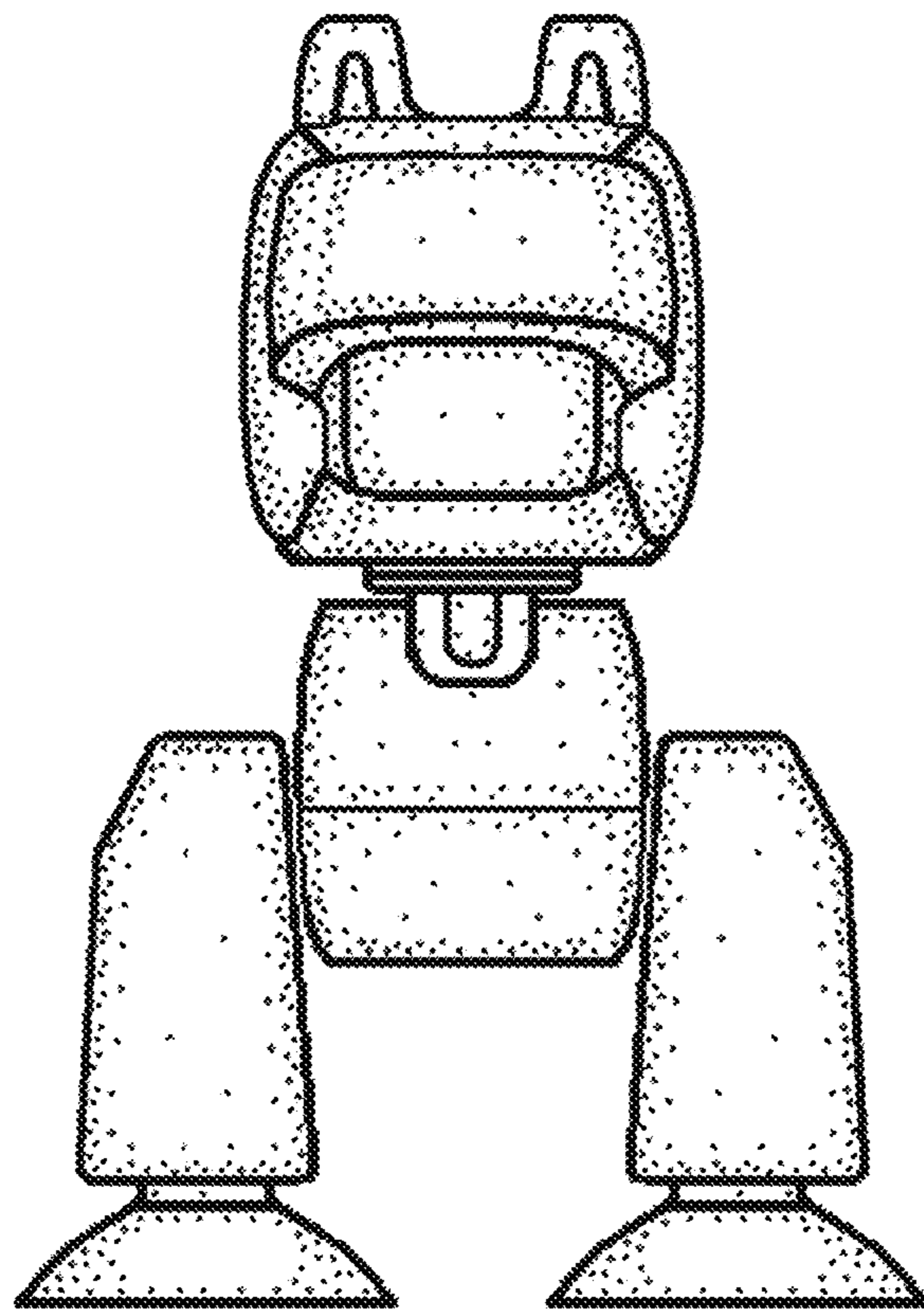

FIG. 2

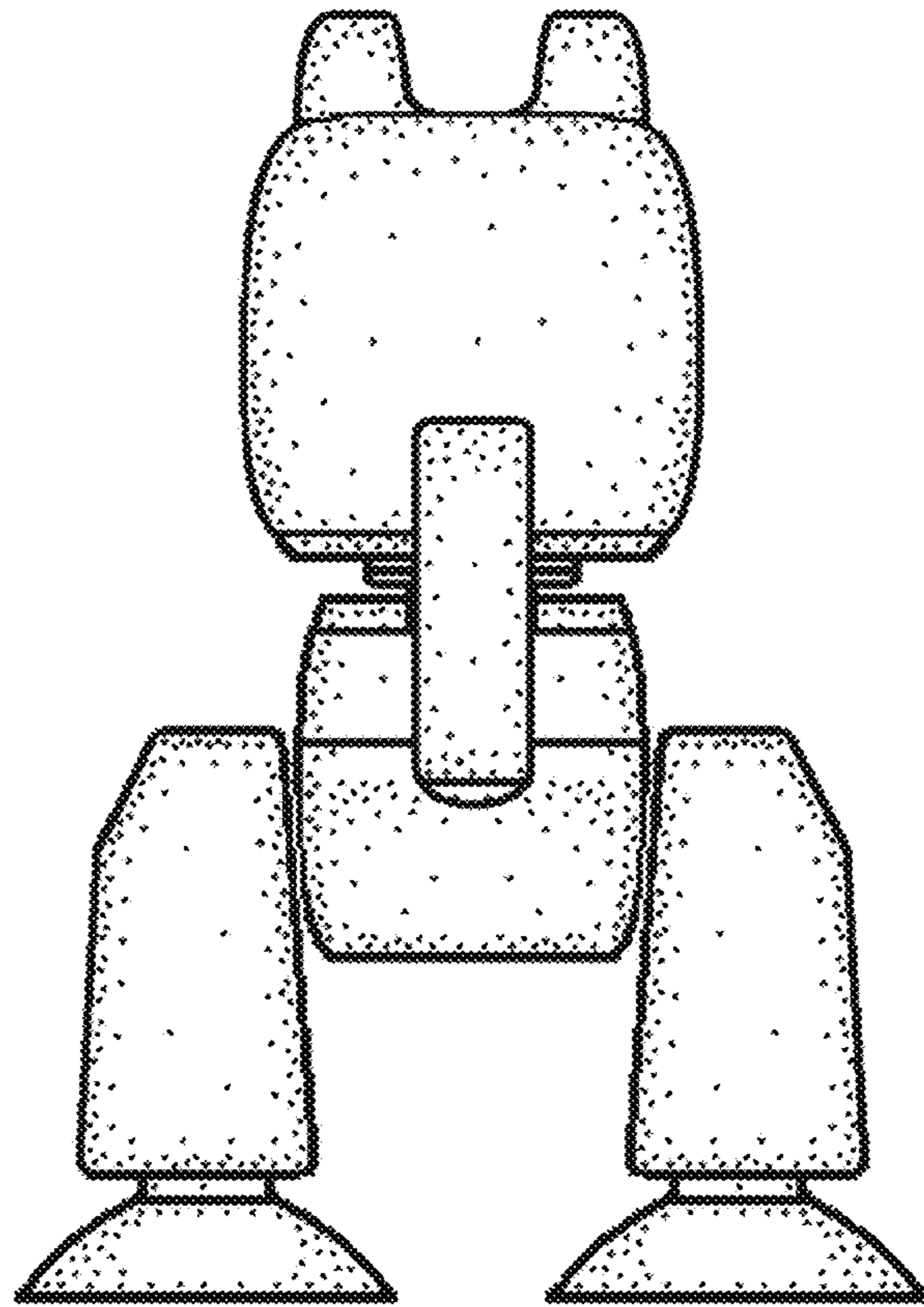

FIG. 3

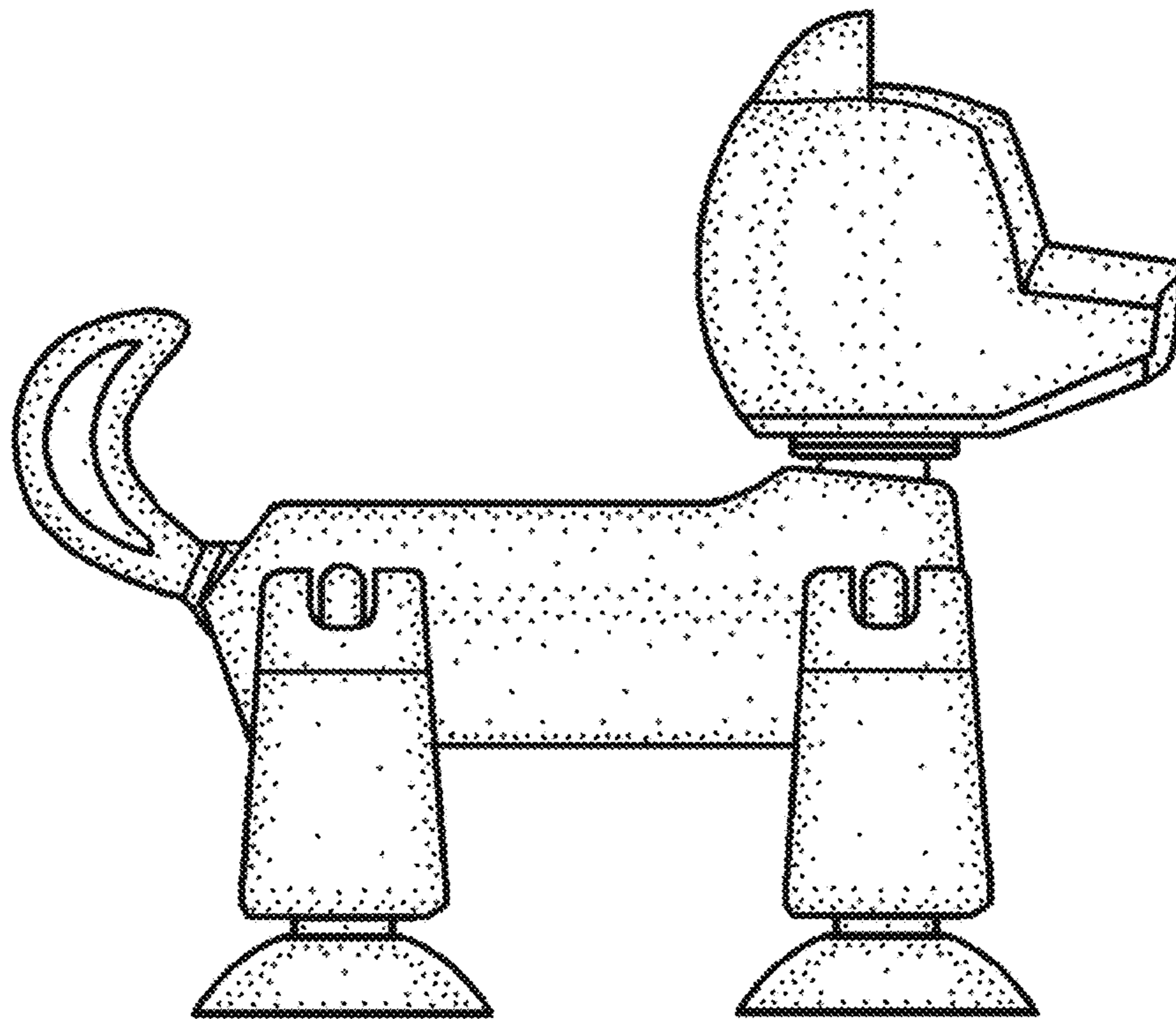

FIG. 4

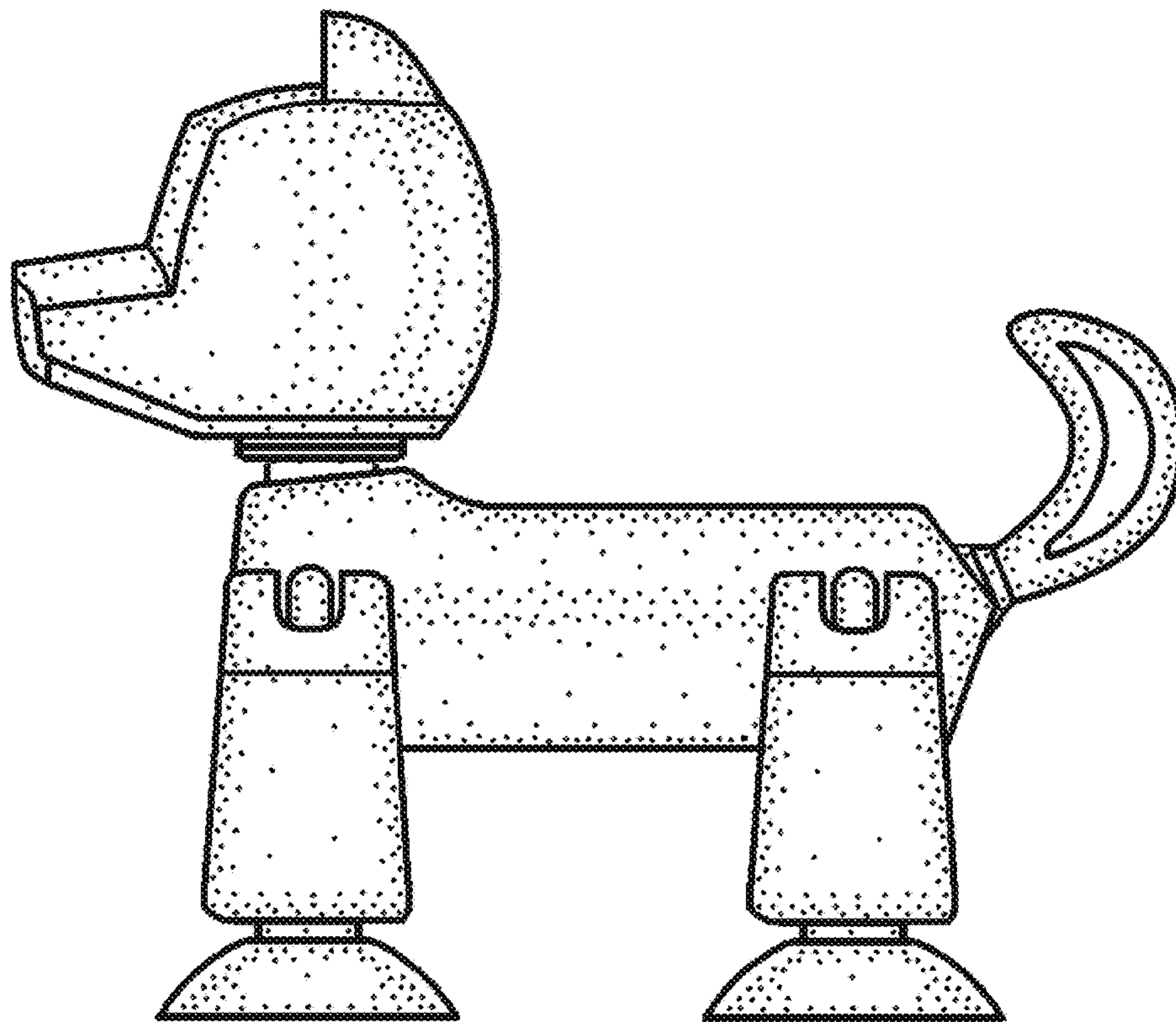

FIG. 5

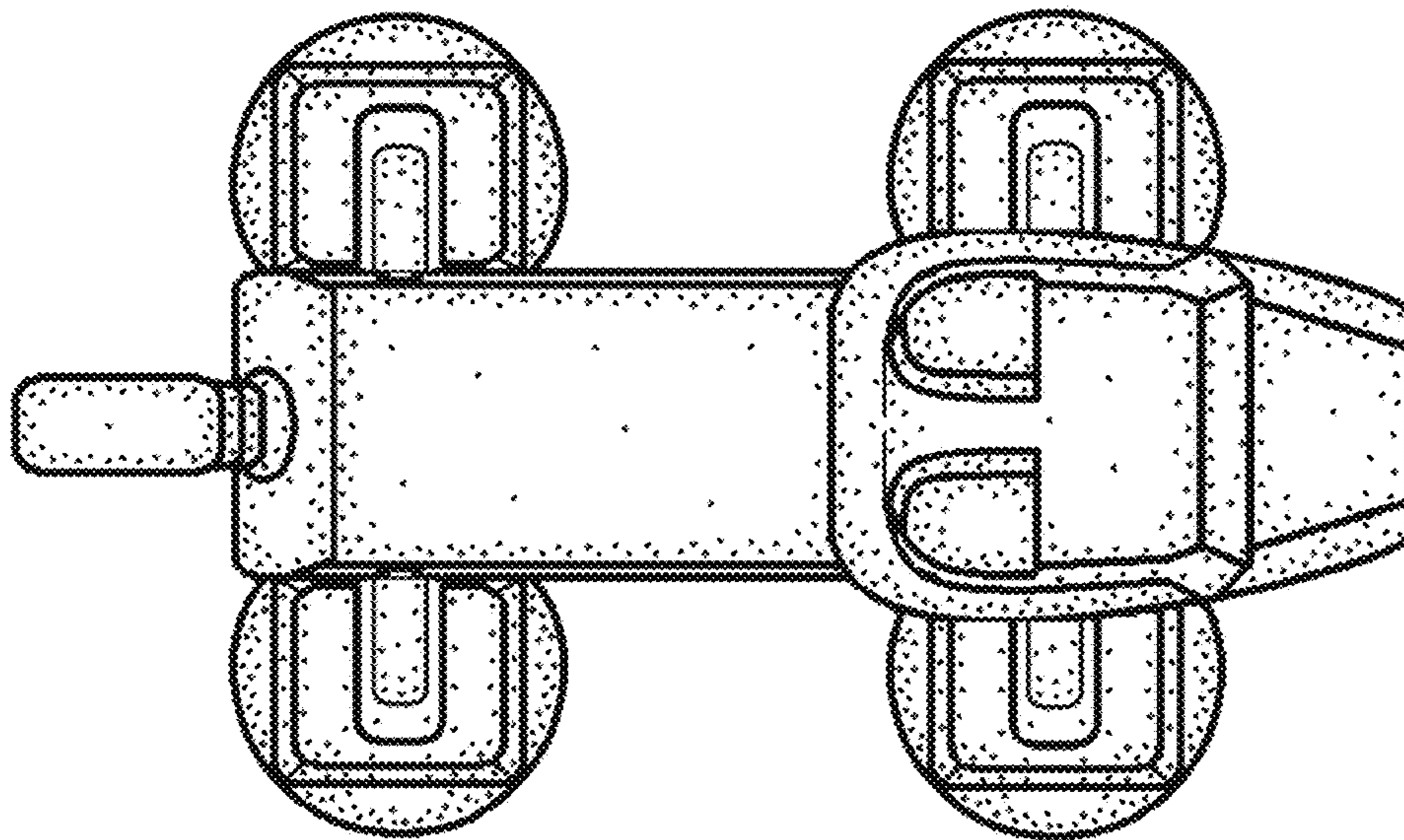

FIG. 6

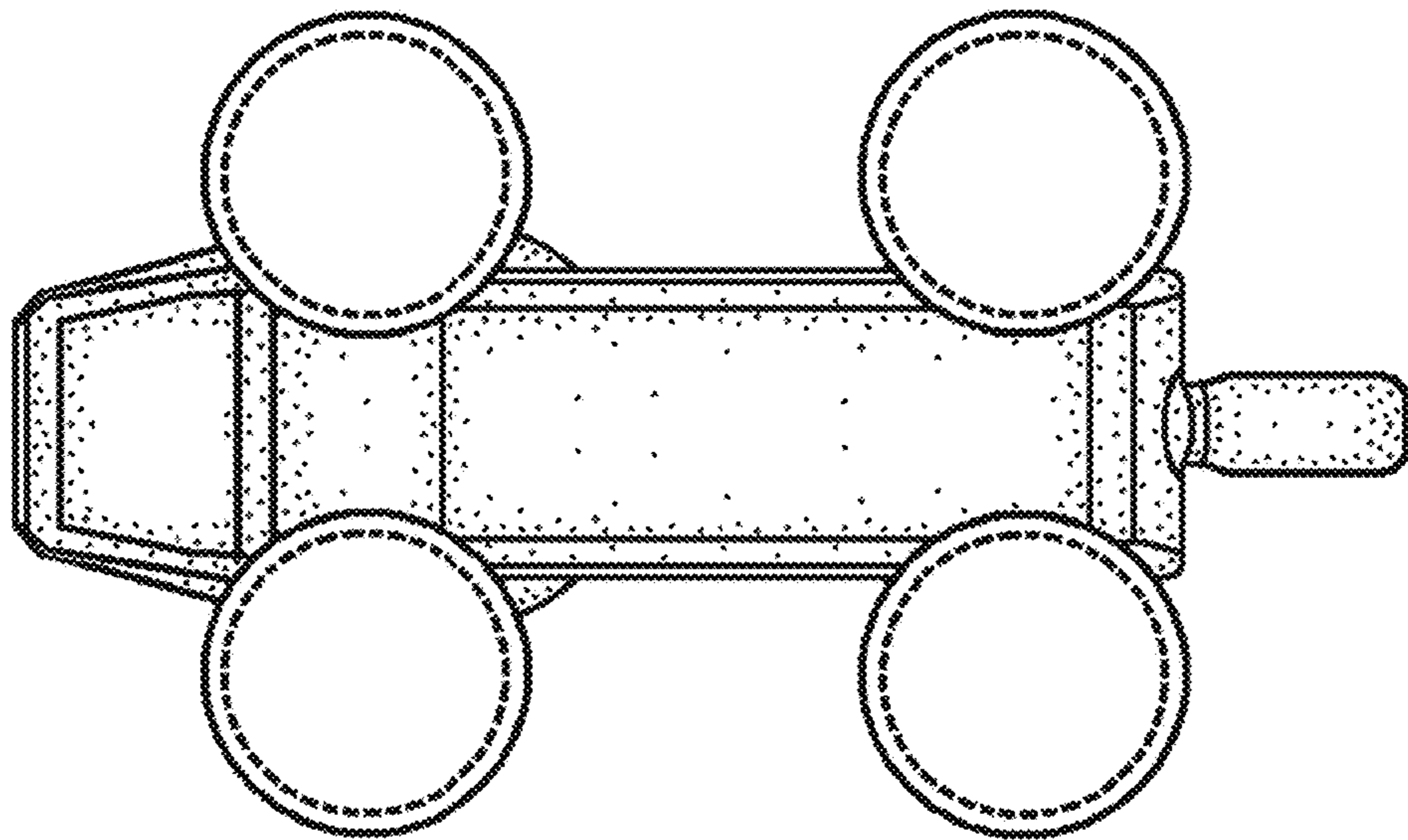

FIG. 7