



US00D848544S

(12) **United States Design Patent** (10) **Patent No.:** **US D848,544 S**
Ma (45) **Date of Patent:** **** May 14, 2019**

(54) **WATER TOY**

(71) Applicant: **SLIS, Inc.**, Darien, IL (US)
(72) Inventor: **Jiadong Ma**, Darien, IL (US)
(73) Assignee: **SLIS INC.**, Darien, IL (US)
(**) Term: **15 Years**

(21) Appl. No.: **29/624,789**

(22) Filed: **Nov. 3, 2017**

(51) **LOC (11) Cl.** **21-01**

(52) **U.S. Cl.**
USPC **D21/575; D23/223**

(58) **Field of Classification Search**
USPC D22/103, 107, 108; D21/567, 570, 573,
D21/574; D23/223, 225
CPC F41B 7/003; F41B 7/08; F41B 7/025
See application file for complete search history.

(56) **References Cited**

U.S. PATENT DOCUMENTS

D314,649	S *	2/1991	Campbell, Sr.	D23/223
D346,647	S *	5/1994	Arnette	D23/225
6,167,925	B1 *	1/2001	D'Andrade	F41B 9/0012
					141/348
D522,070	S *	5/2006	Hunter	D21/570
D540,430	S *	4/2007	Liao	D23/223
D557,355	S *	12/2007	Higuchi	D21/572
D642,226	S *	7/2011	Walterscheid	D21/436
8,074,838	B1 *	12/2011	Tate	F41B 9/00
					222/429
D655,765	S *	3/2012	Johnson	D21/574
D660,921	S *	5/2012	Johnson	D21/572
D661,356	S *	6/2012	Kleinkopf	D21/574
D747,441	S *	1/2016	Naslund	D23/223
D769,413	S *	10/2016	Liao	D23/223
D803,984	S *	11/2017	Tschopp	D23/226
2006/0242880	A1 *	11/2006	Griffin	F41C 23/04
					42/73

OTHER PUBLICATIONS

LED Water Faucet LEDMO, https://www.amazon.com/gp/product/B01L6MMFBC/ref=oh_aui_detailpage_o02_s00?ie=UTF8&psc=1, Feb. 2, 2018, 6 pgs.
Soledi LED Water Stream Tap Glow Shower Head Faucet Light, https://www.amazon.com/gp/product/B00PZBTLGI/ref=oh_aui_detailpage_o02_s00?ie=UTF8&psc=1, Feb. 2, 2018, 7 pgs.
LEDMO LED Shower Head, https://www.amazon.com/gp/product/B01L6N1SKU/ref=oh_aui_detailpage_o02_s01?ie=UTF8&psc=1, Feb. 2, 2018, 8 pgs.
2 LED Water Blaster Guns, https://www.amazon.com/Water-Blaster-Flashing-Colorful-Lights/dp/B075JYP2CF/ref=sr_1_2?s=toys-and-games&ie=UTF8&qid=1517599322&sr=1-2&keywords=light+up+water+splash, Feb. 2, 2018, 6 pgs.

(Continued)

Primary Examiner — Robin V Webster
Assistant Examiner — Keith J Wilson
(74) *Attorney, Agent, or Firm* — Greenberg Traurig, LLP

(57) **CLAIM**

The ornamental design for a water toy, as shown and described.

DESCRIPTION

FIG. 1 is a perspective view of a water toy of the present design;
FIG. 2 is a right side view thereof;
FIG. 3 is a left side view thereof;
FIG. 4 is a rear view thereof;
FIG. 5 is a front view thereof;
FIG. 6 is a bottom view thereof; and,
FIG. 7 is a top view thereof.
The broken lines shown in the drawings are for illustrative purposes only and form no part of the claimed design.

1 Claim, 5 Drawing Sheets

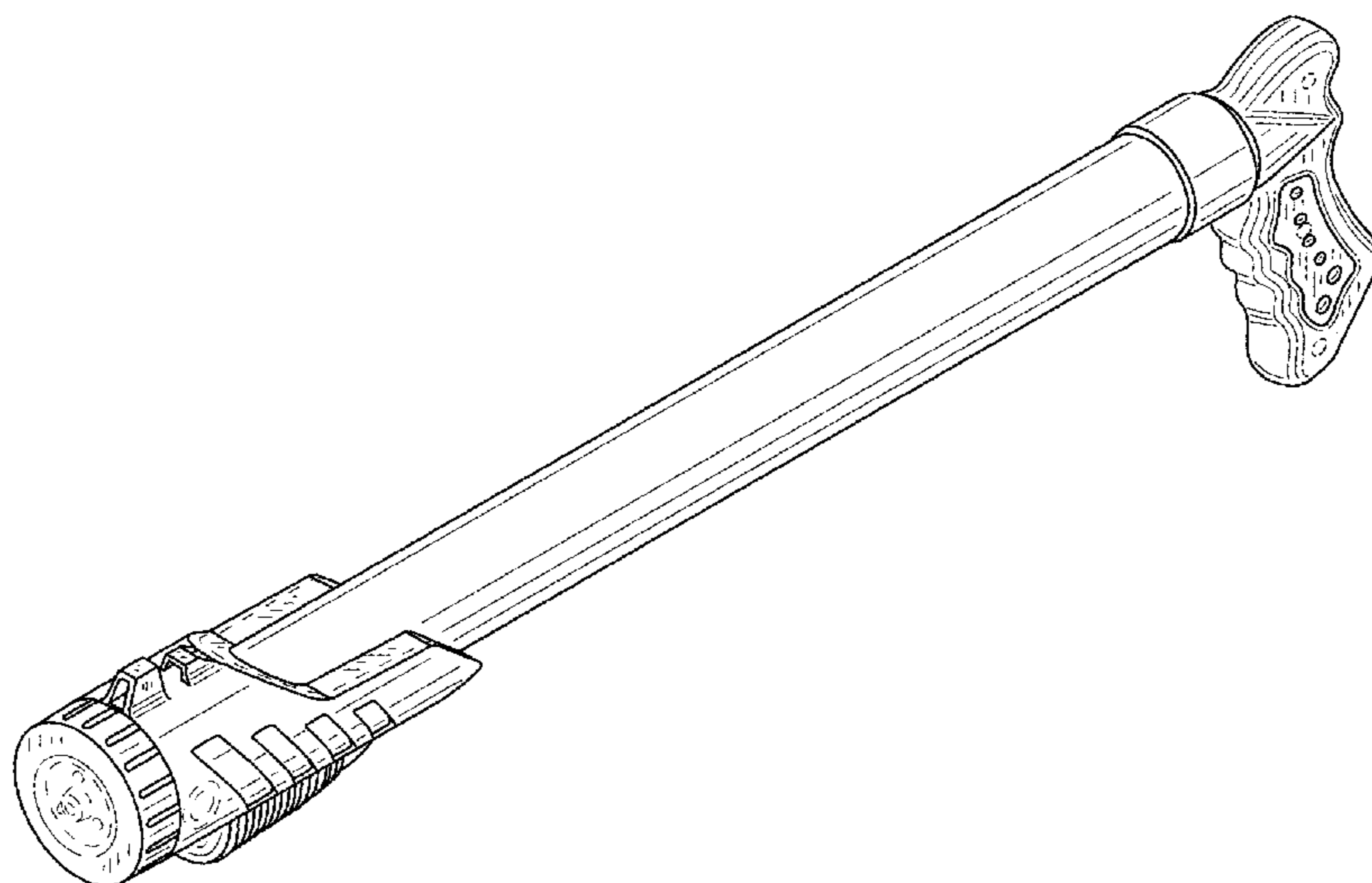

(56)

References Cited

OTHER PUBLICATIONS

Tidal Storm Light-Up Water Blaster, https://www.amazon.com/Tidal-Storm-Light-Up-Blaster-Completely/dp/B06ZZXKK6Y/ref=sr_1_1?s=toys-and-games&ie=UTF8&qid=1517599322&sr=1-1&keywords=light+up+water+splash, Feb. 2, 2018, 6 pgs.

Led Water Spray Gun, https://www.alibaba.com/product-detail/led-water-spray-gun-novelty-pool_60404180666.html, Feb. 2, 2018, 18 pgs.

Bubble Ray Gun (Toy), <http://www.tobar.co.uk/bubble-ray-gun>, Feb. 2, 2018, 2 pgs.

* cited by examiner

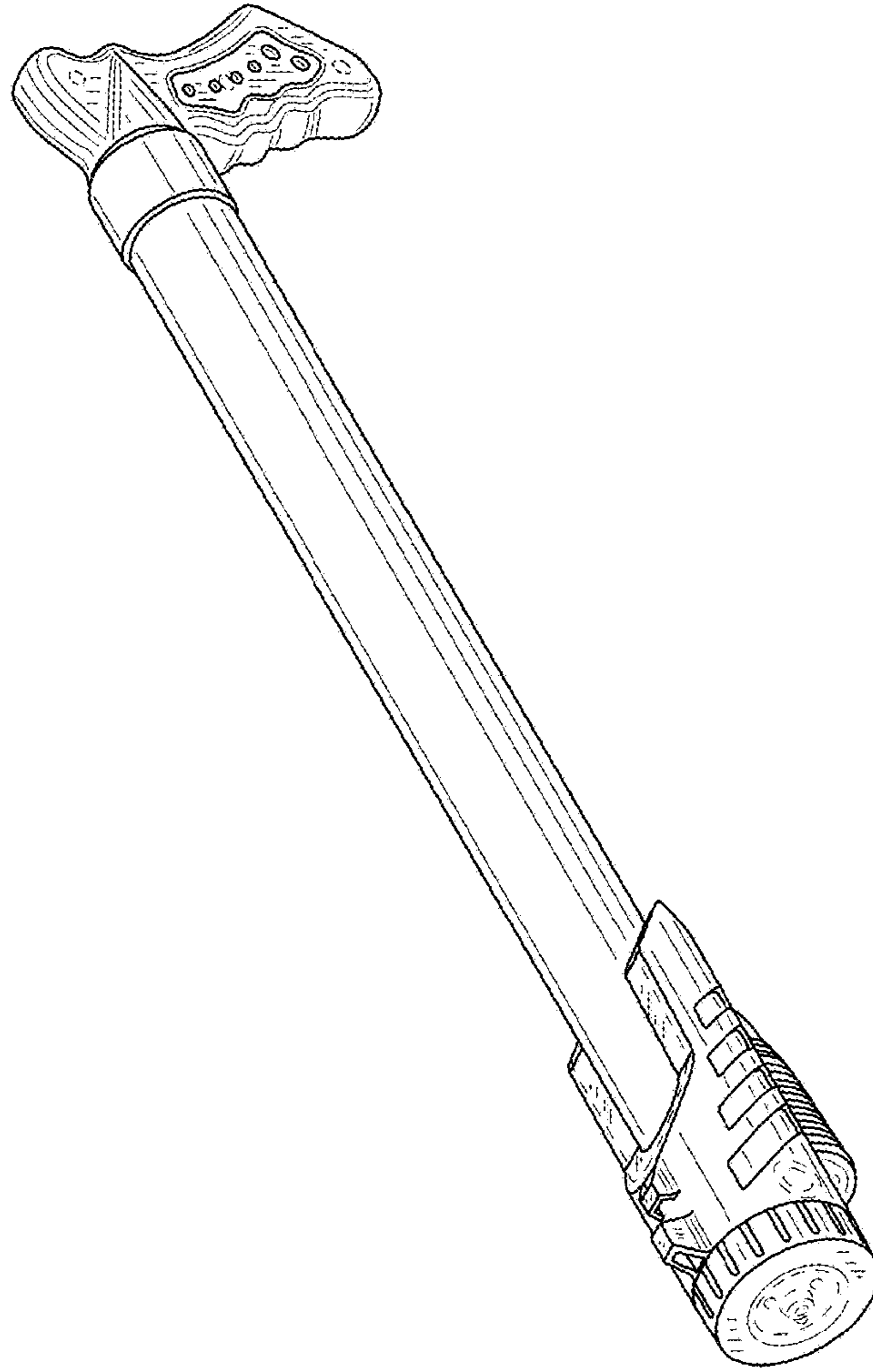

FIG.1

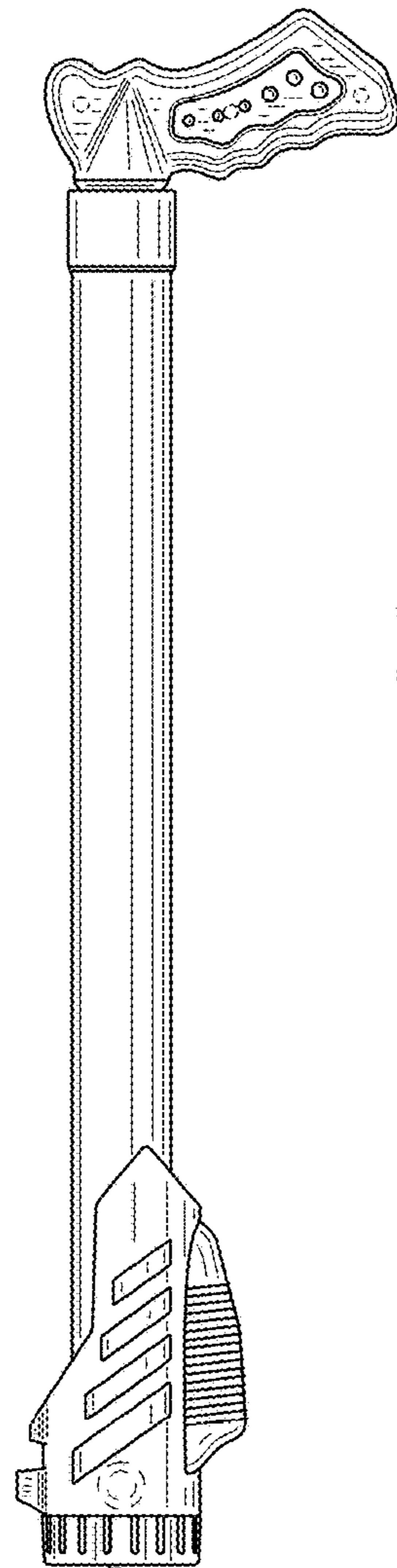
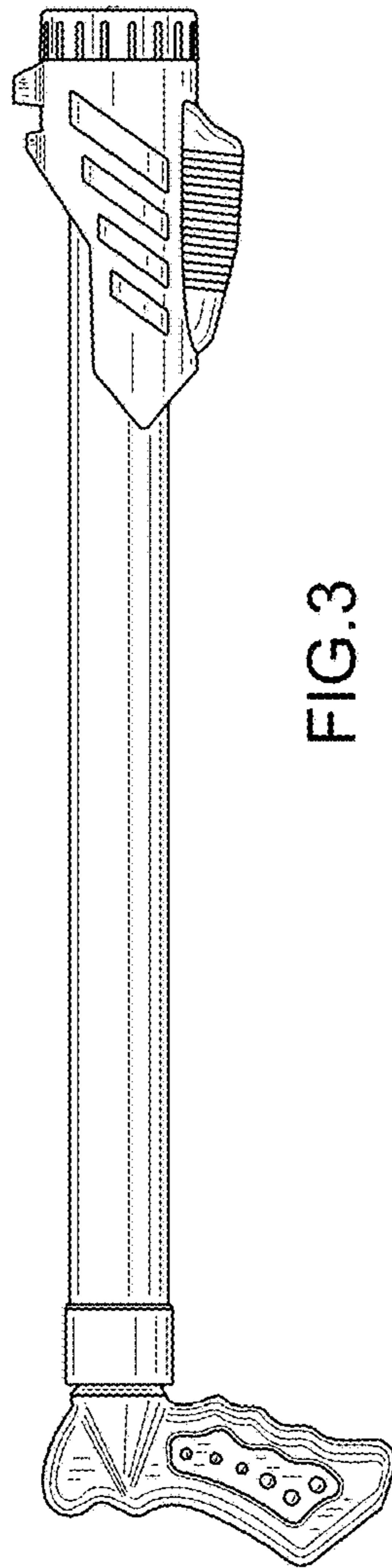

FIG.2



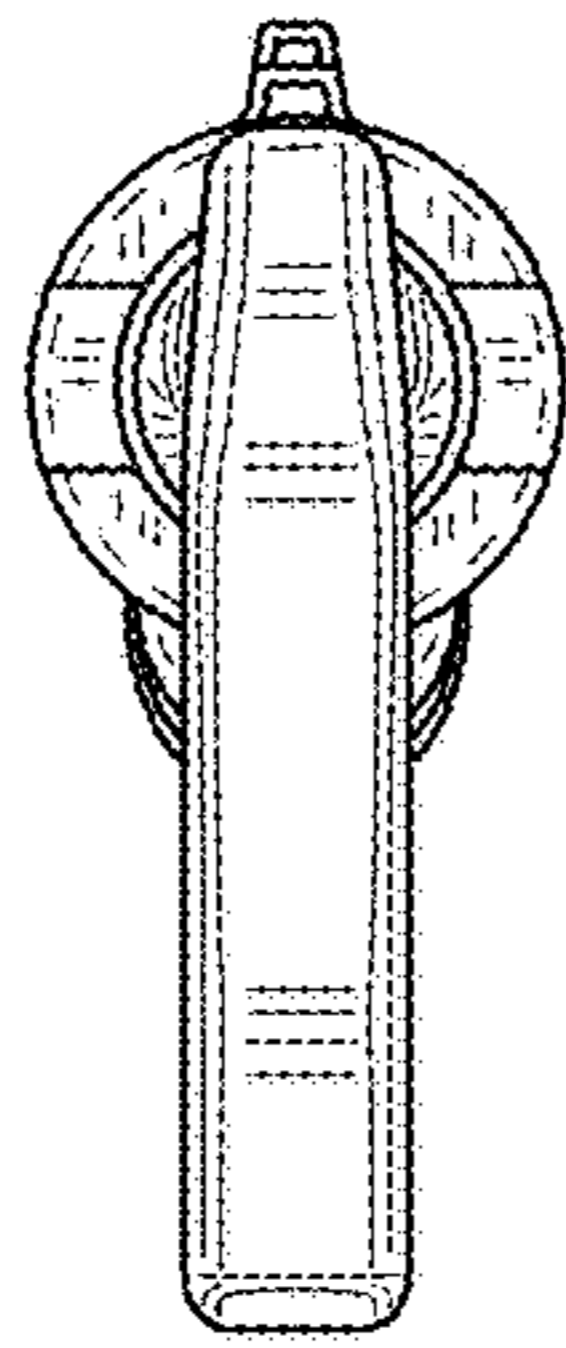

FIG.4

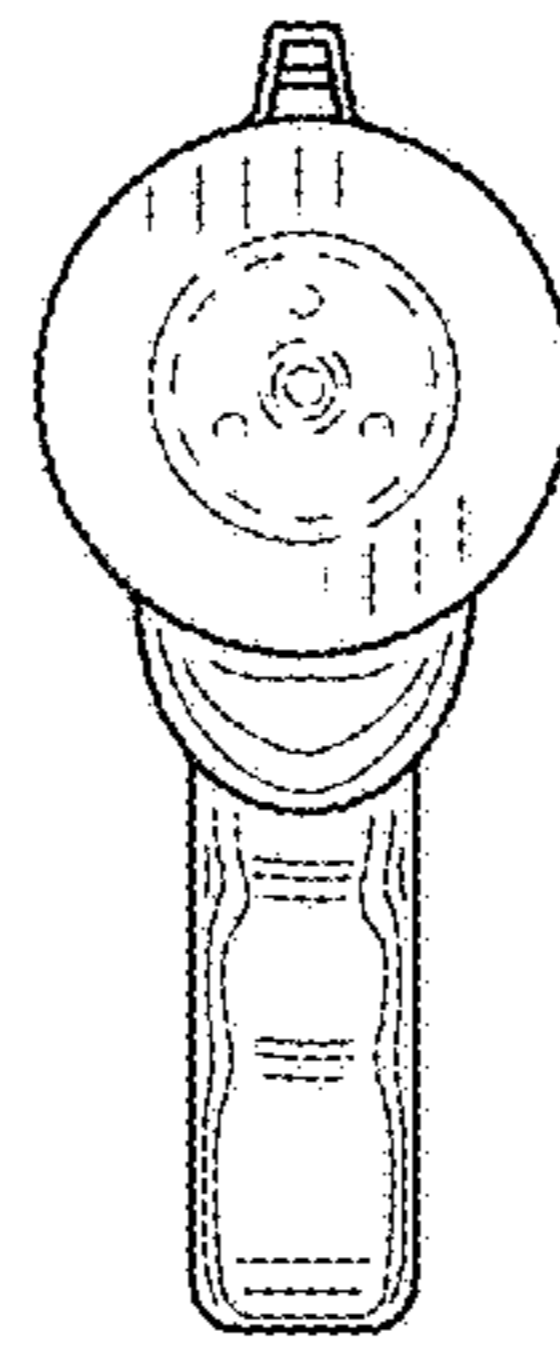

FIG.5

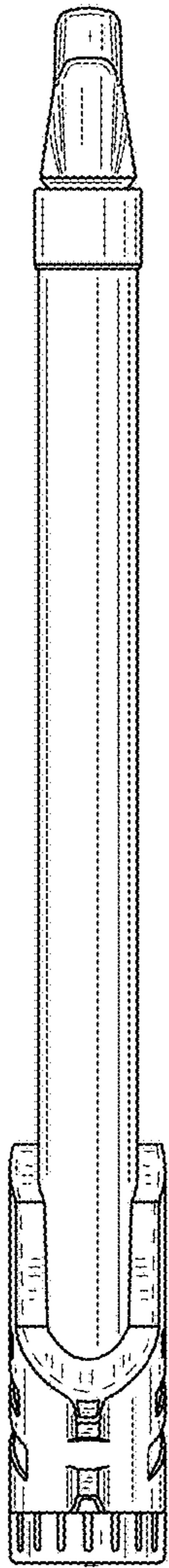

FIG. 6

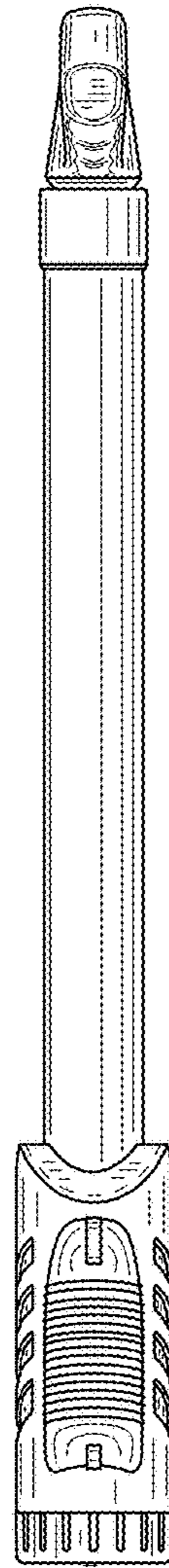

FIG. 7