



US00D848531S

(12) **United States Design Patent** (10) **Patent No.:** **US D848,531 S**  
**Shaw-Smith** (45) **Date of Patent:** **\*\* May 14, 2019**

(54) **SIGN ASSEMBLY**

(71) Applicant: **Mssdesign Ltd.**, Oxfordshire (GB)  
(72) Inventor: **Mark Shaw-Smith**, Oxfordshire (GB)  
(73) Assignee: **Mssdesign Ltd.**, Oxfordshire (GB)  
(\*\*) Term: **15 Years**  
(21) Appl. No.: **29/593,966**

(22) Filed: **Feb. 14, 2017**  
(51) **LOC (11) Cl.** ..... **20-03**  
(52) **U.S. Cl.**  
USPC ..... **D20/42**  
(58) **Field of Classification Search**  
USPC ..... D6/300, 315, 512; D8/349, 373;  
D19/1-8; D20/10, 21-23, 25, 27, 29-33,  
D20/37, 40-44, 99  
CPC ..... A63H 3/14; A63H 33/00; A63H 17/38;  
G09F 3/204; G09F 3/00; G09F 3/08;  
G09F 3/18; G09F 3/20; G09F 3/185;  
G09F 21/00; G09F 21/02  
See application file for complete search history.

(56) **References Cited**

**U.S. PATENT DOCUMENTS**

D29,150 S *	8/1898	Fleischman	.....	D8/349
D450,567 S *	11/2001	Holscher	.....	D8/373
D611,284 S *	3/2010	Bertke	.....	D6/567
D641,794 S *	7/2011	Yi	.....	D20/42
D649,195 S *	11/2011	Yi	.....	D20/15
8,181,419 B1 *	5/2012	diGirolamo	.....	E04B 2/768 248/909
D663,020 S *	7/2012	Purnell	.....	D23/386
D664,204 S	7/2012	Bell		
D665,456 S	8/2012	Bell		
D677,505 S *	3/2013	Walton	.....	D6/552
D696,096 S *	12/2013	Daneman	.....	D8/349
8,695,254 B2	4/2014	Bell		
D735,174 S *	7/2015	Wengreen	.....	D14/238

(Continued)

**OTHER PUBLICATIONS**

APCO Graphics, Inc.; "Elevate Frameless Sign System" web page retrieved from <http://www.apcosigns.com/elevate.html#> on Feb. 17, 2017 (2 pages).

(Continued)

*Primary Examiner* — Mary Ann Calabrese  
*Assistant Examiner* — Catherine Ho  
(74) *Attorney, Agent, or Firm* — Nixon Peabody LLP

(57) **CLAIM**

I claim the ornamental design for a sign assembly, as shown and described.

**DESCRIPTION**

FIG. 1 is a perspective view for a sign assembly, showing my new design in an assembled configuration.  
FIG. 2 is a front view for a component for a sign assembly, isolated for clarity of disclosure.  
FIG. 3 is a left side view thereof.  
FIG. 4 is a right side view thereof.  
FIG. 5 is a top view thereof.  
FIG. 6 is a bottom view thereof.  
FIG. 7 is a back view thereof.  
FIG. 8 is a front view of another component for a sign assembly, isolated for clarity for disclosure.  
FIG. 9 is a left side view thereof.  
FIG. 10 is a right side view thereof.  
FIG. 11 is a top view thereof.  
FIG. 12 is a bottom view thereof.  
FIG. 13 is a back view thereof; and,  
FIG. 14 is an exploded view of a sign assembly shown in an environment use.  
All broken line portions of the figure drawings is included to show portions of the article that form no part of the claimed design.

**1 Claim, 4 Drawing Sheets**

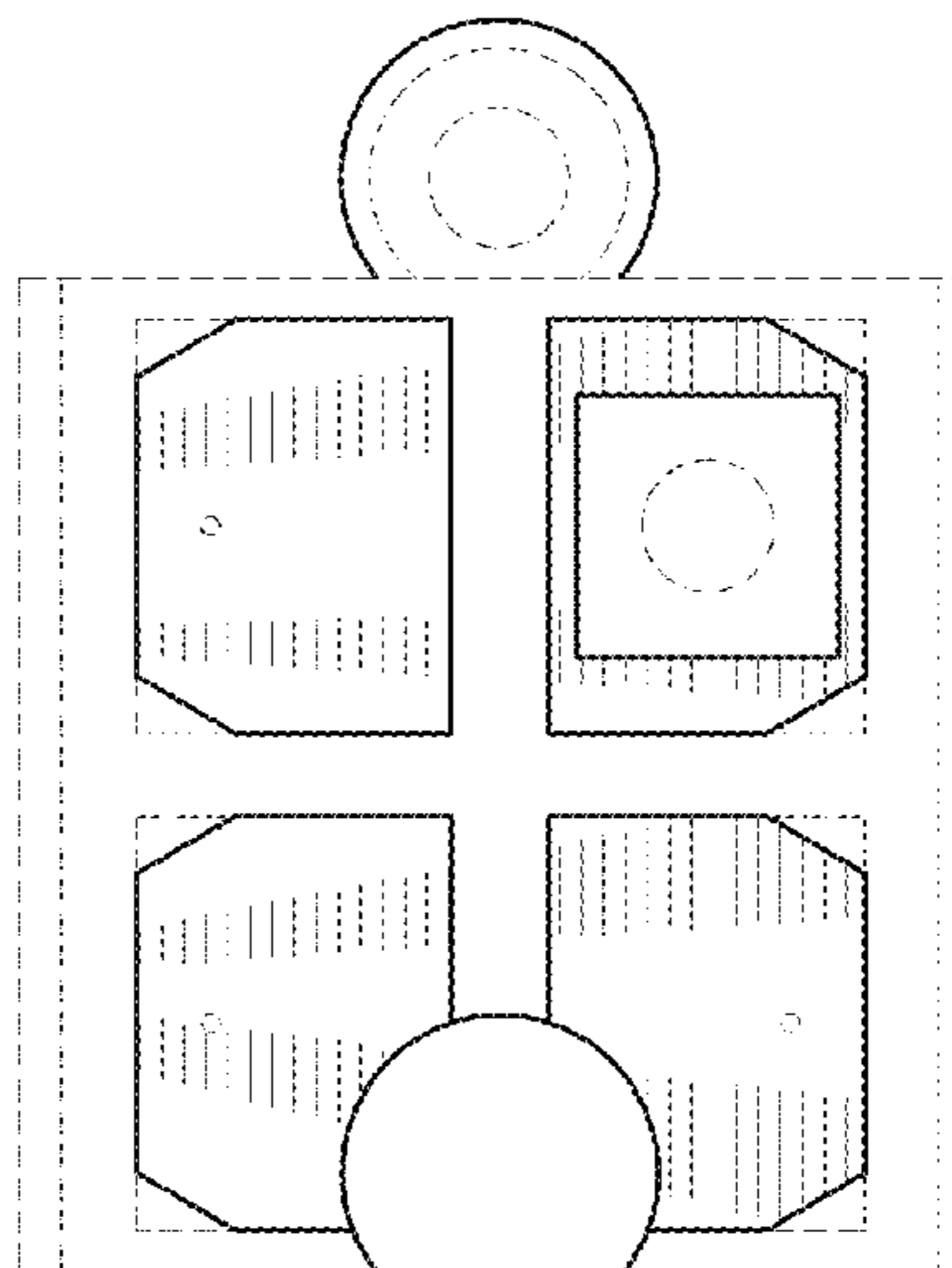
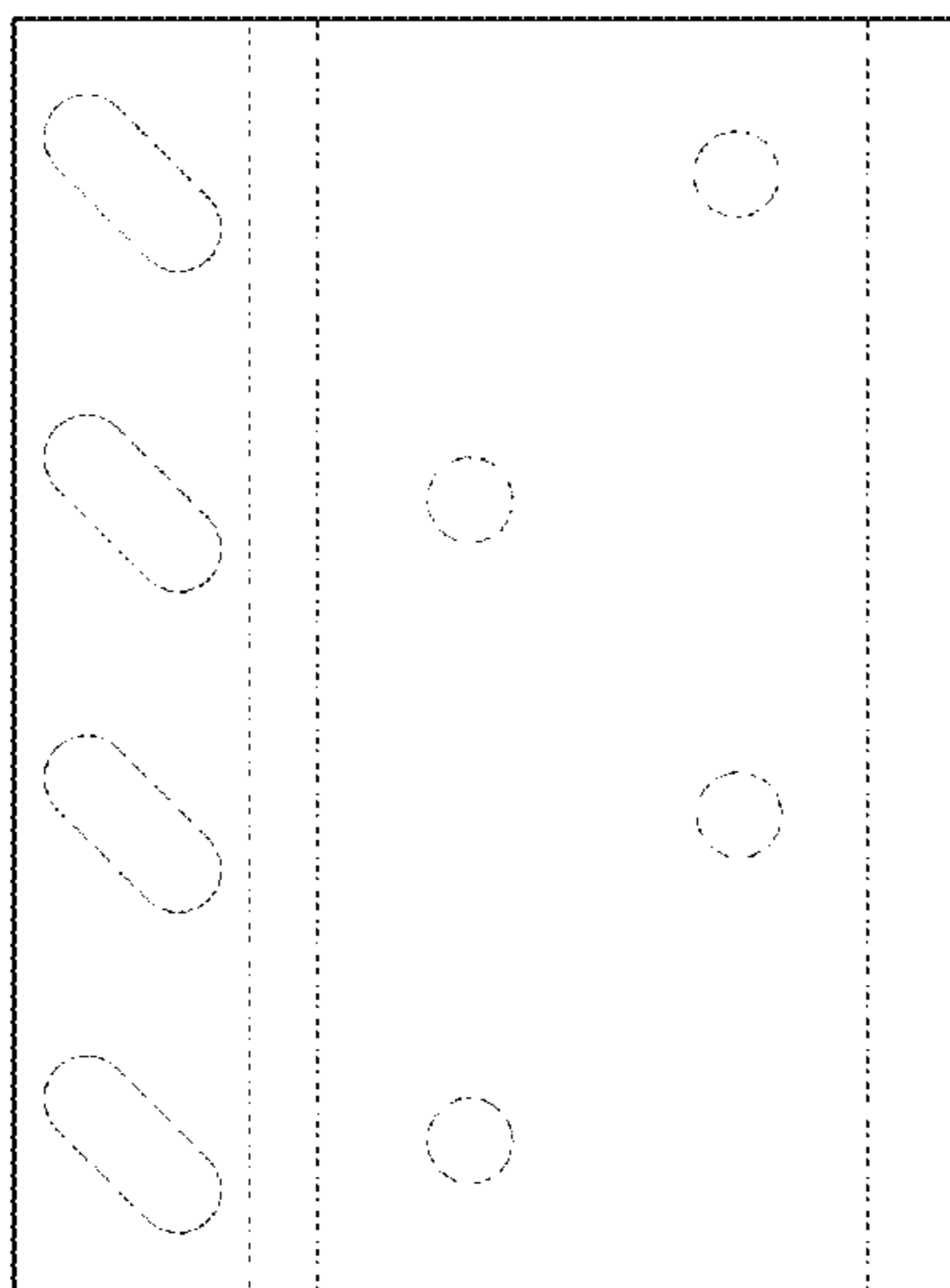

(56)

**References Cited**

U.S. PATENT DOCUMENTS

D739,208 S \* 9/2015 Shirley ..... D8/349  
D788,871 S \* 6/2017 Storch ..... D22/108

OTHER PUBLICATIONS

APCO Graphics, Inc.; “Elevate Frameless Sign System—Technical Information” web page retrieved from <http://www.apcosigns.com/elevate.html#> on Feb. 17, 2017 (14 pages).

APCO Graphics, Inc.; “Elevate Frameless Sign System” brochure; retrieved from <http://www.apcosigns.com/elevate.html#> on Feb. 17, 2017 (16 pages).

\* cited by examiner

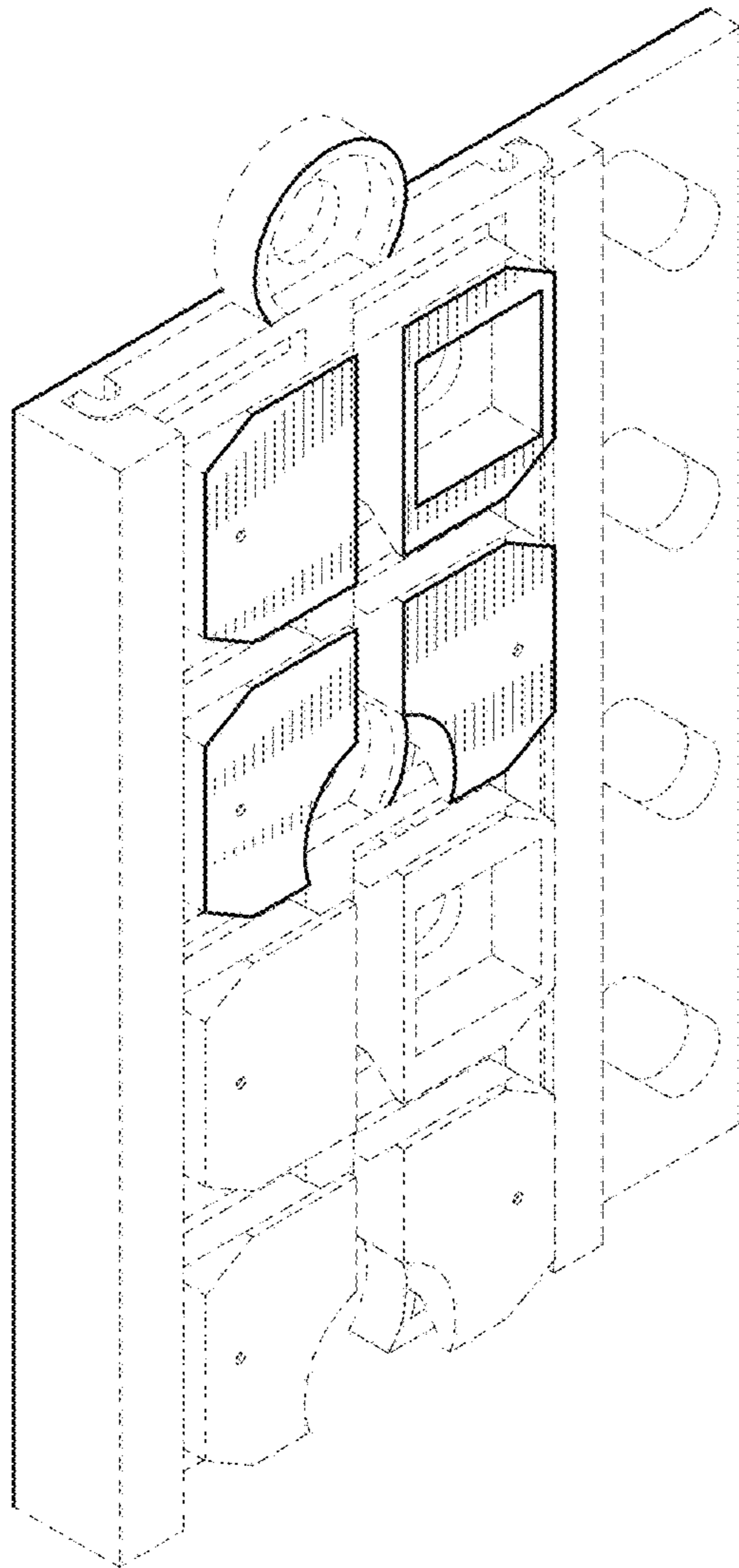

FIG. 1

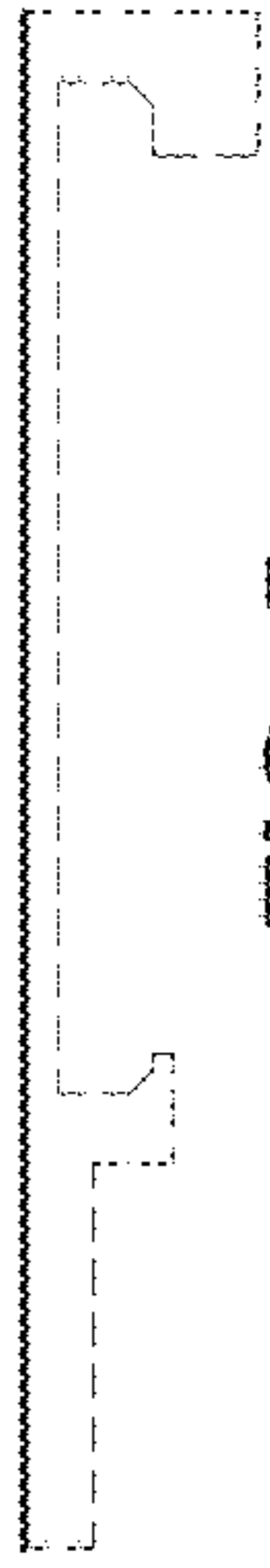

FIG. 5

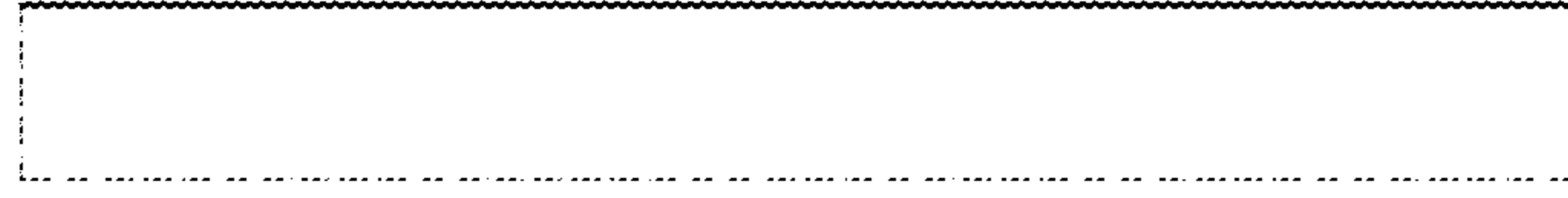

FIG. 4

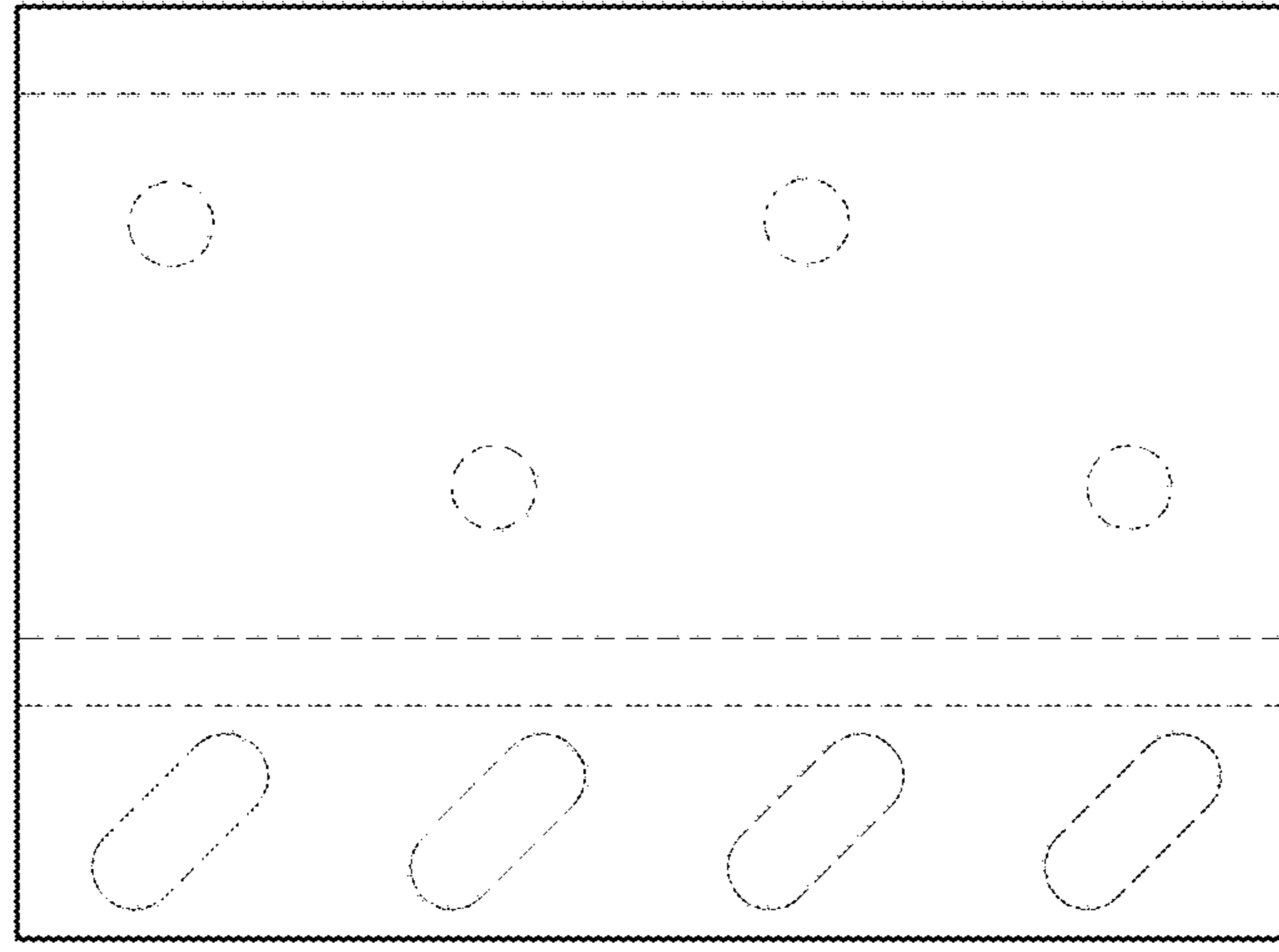

FIG. 2

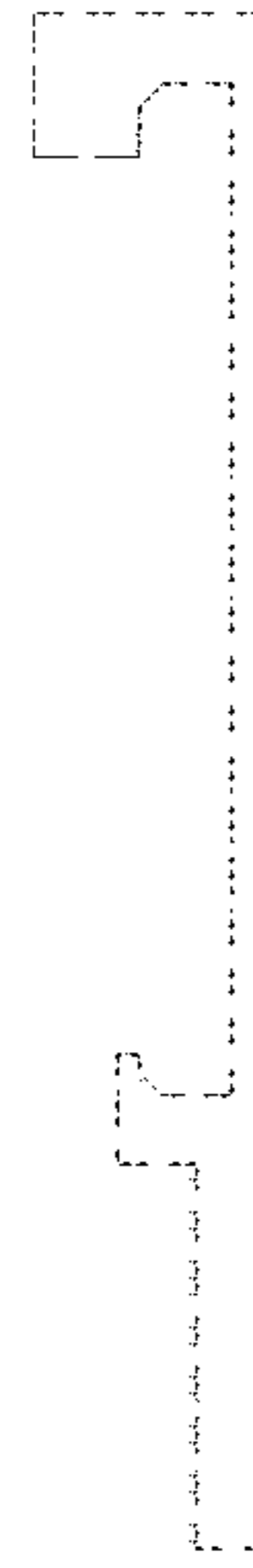

FIG. 6

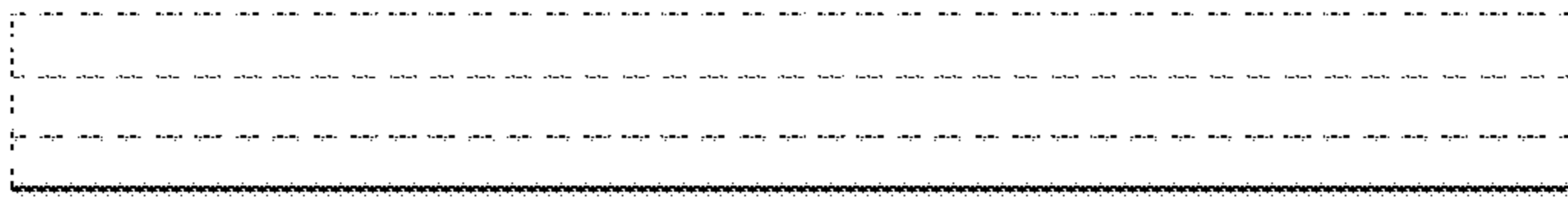

FIG. 3

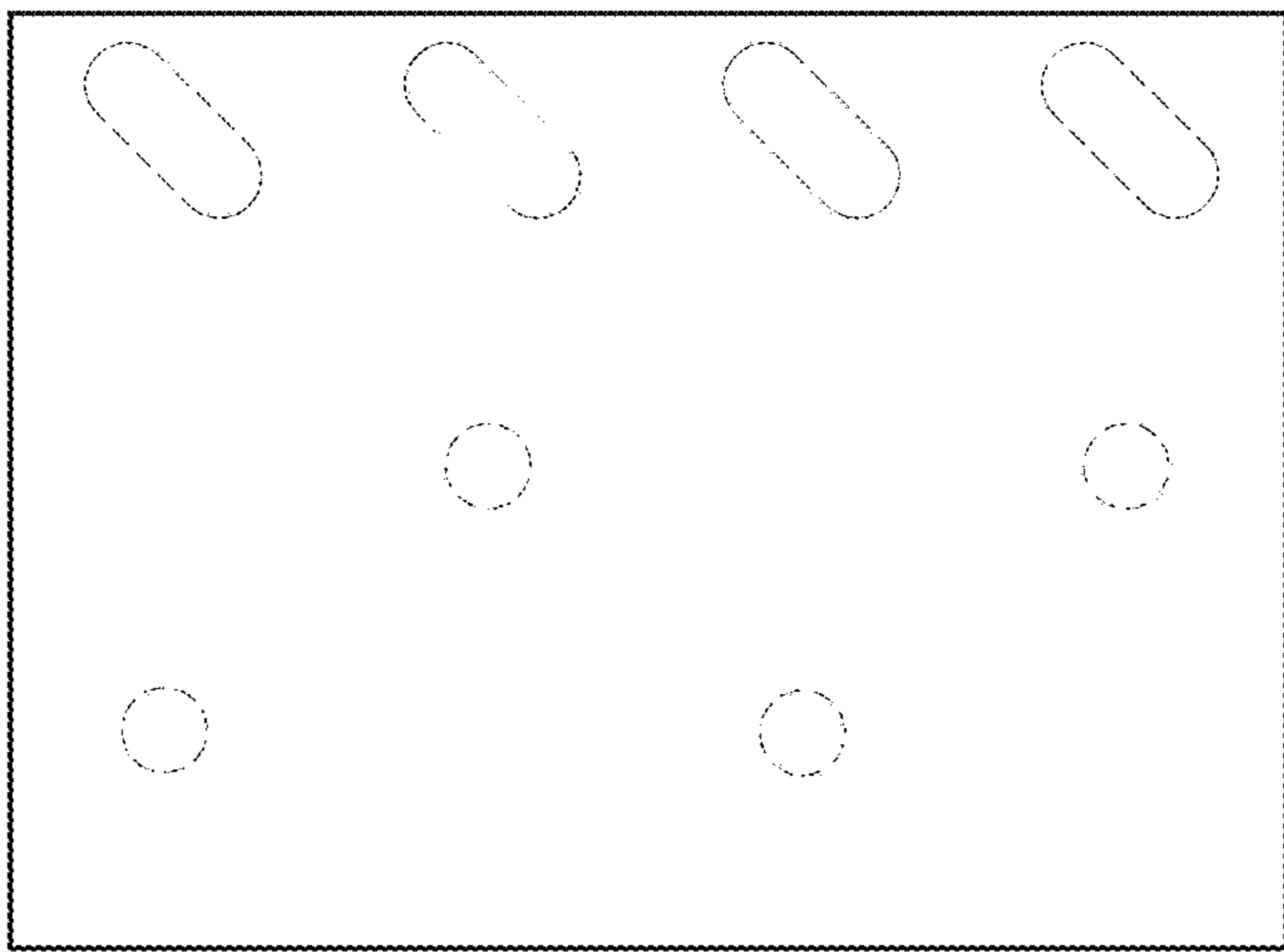

FIG. 7

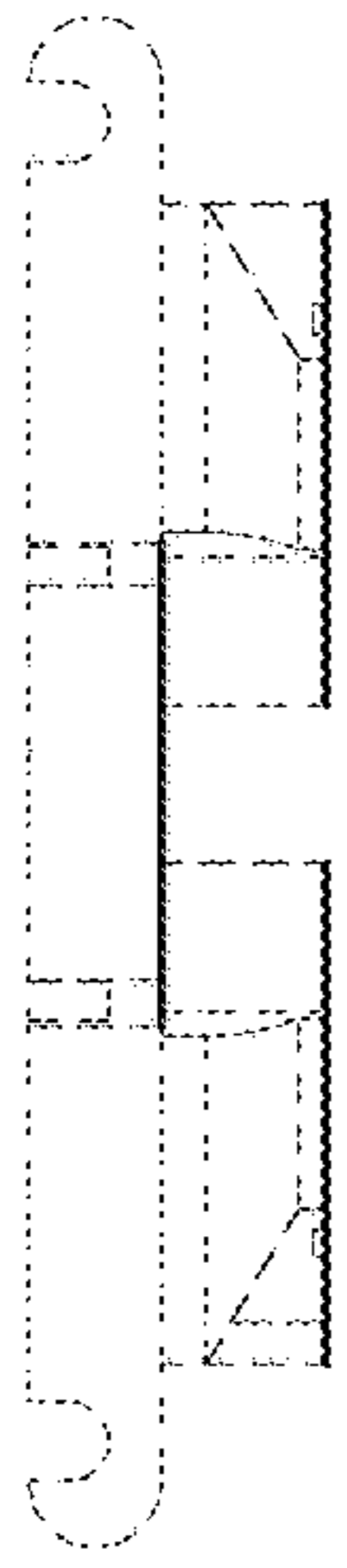

FIG. 11

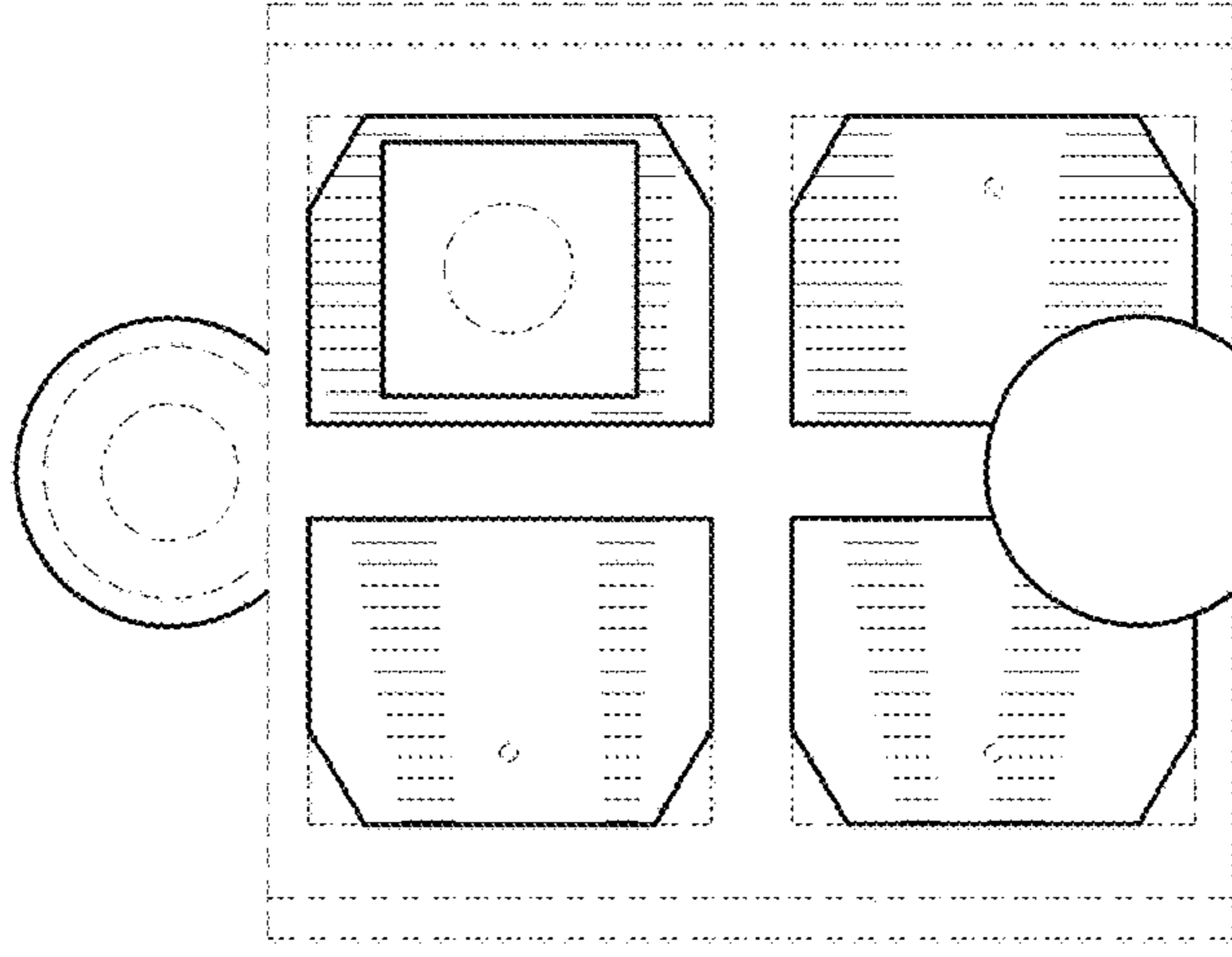

FIG. 8

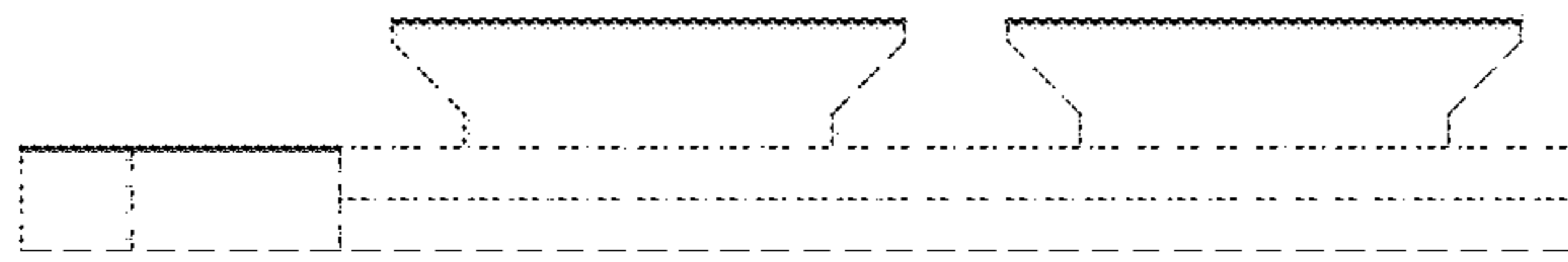

FIG. 9

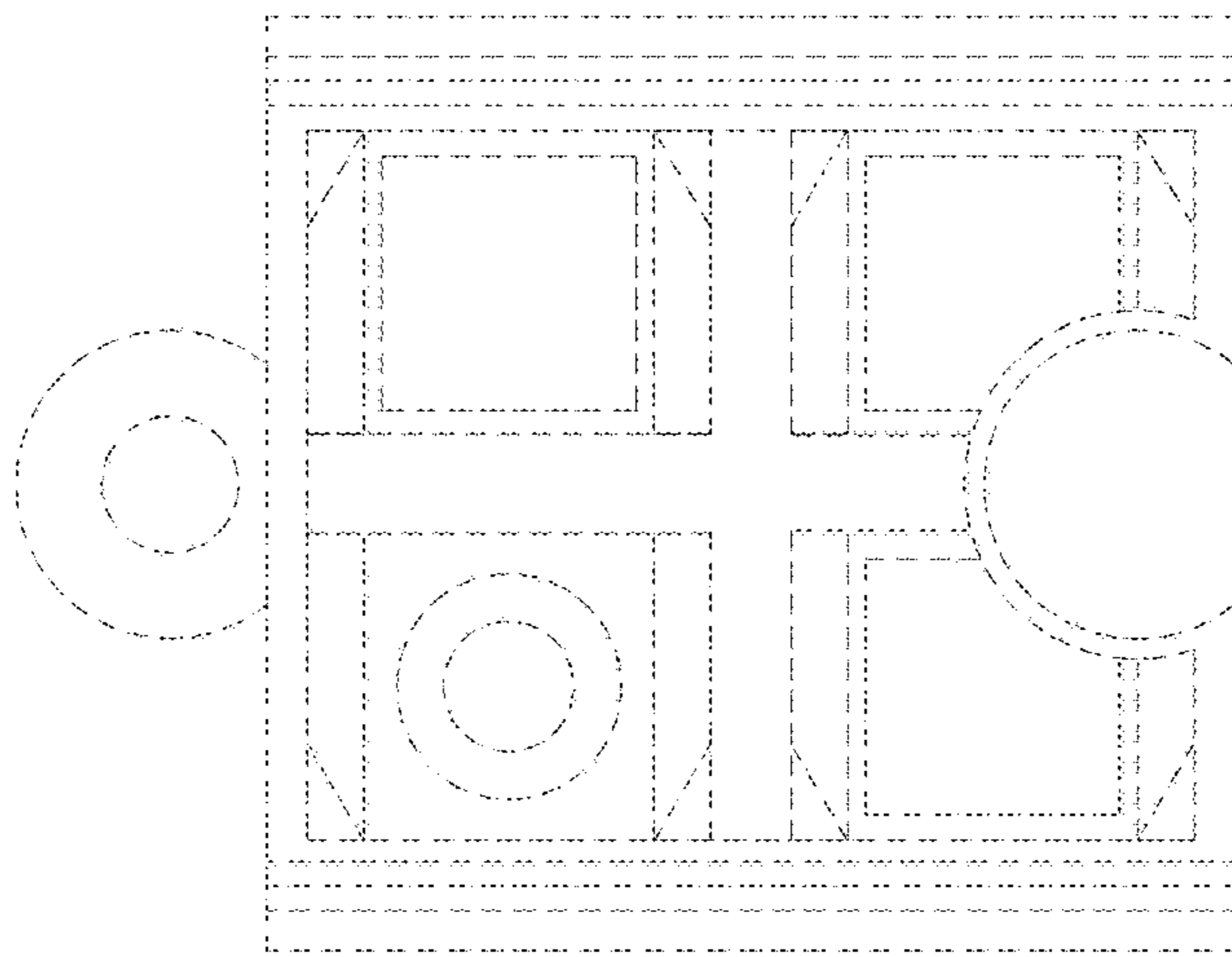

FIG. 13

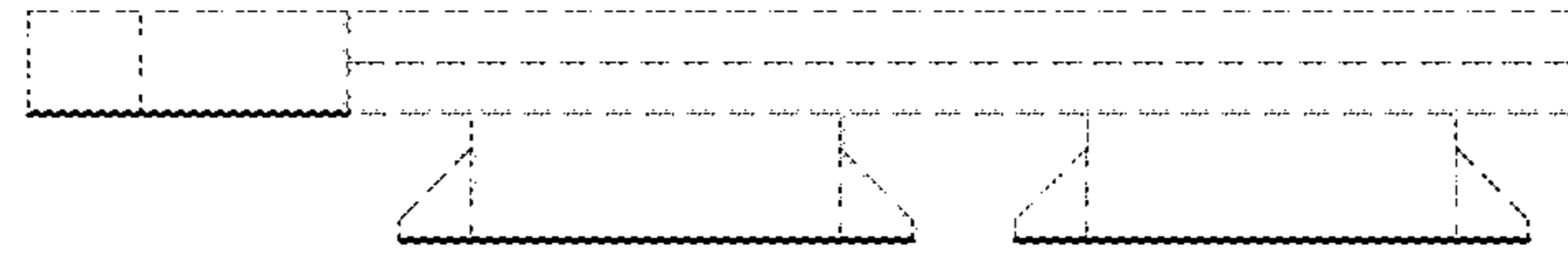

FIG. 10

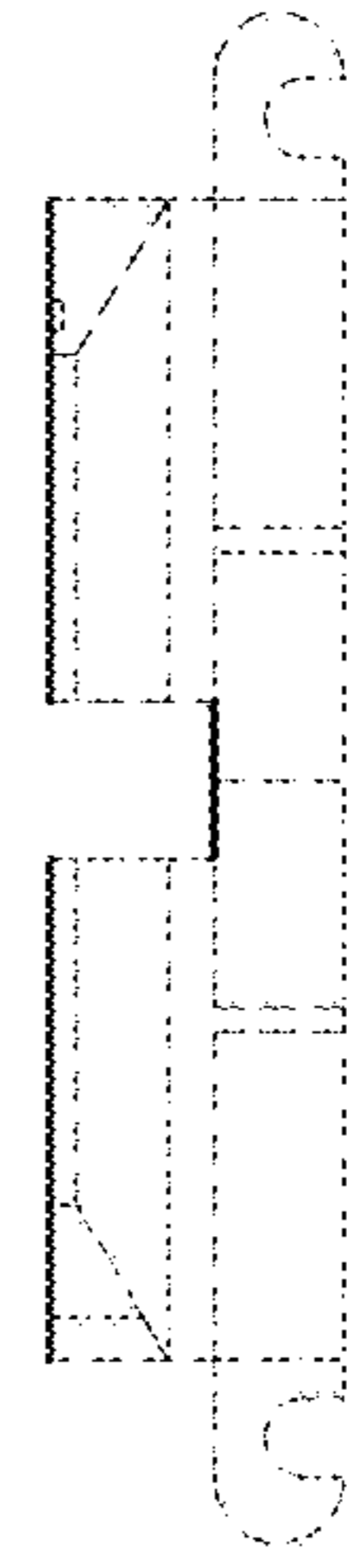

FIG. 12



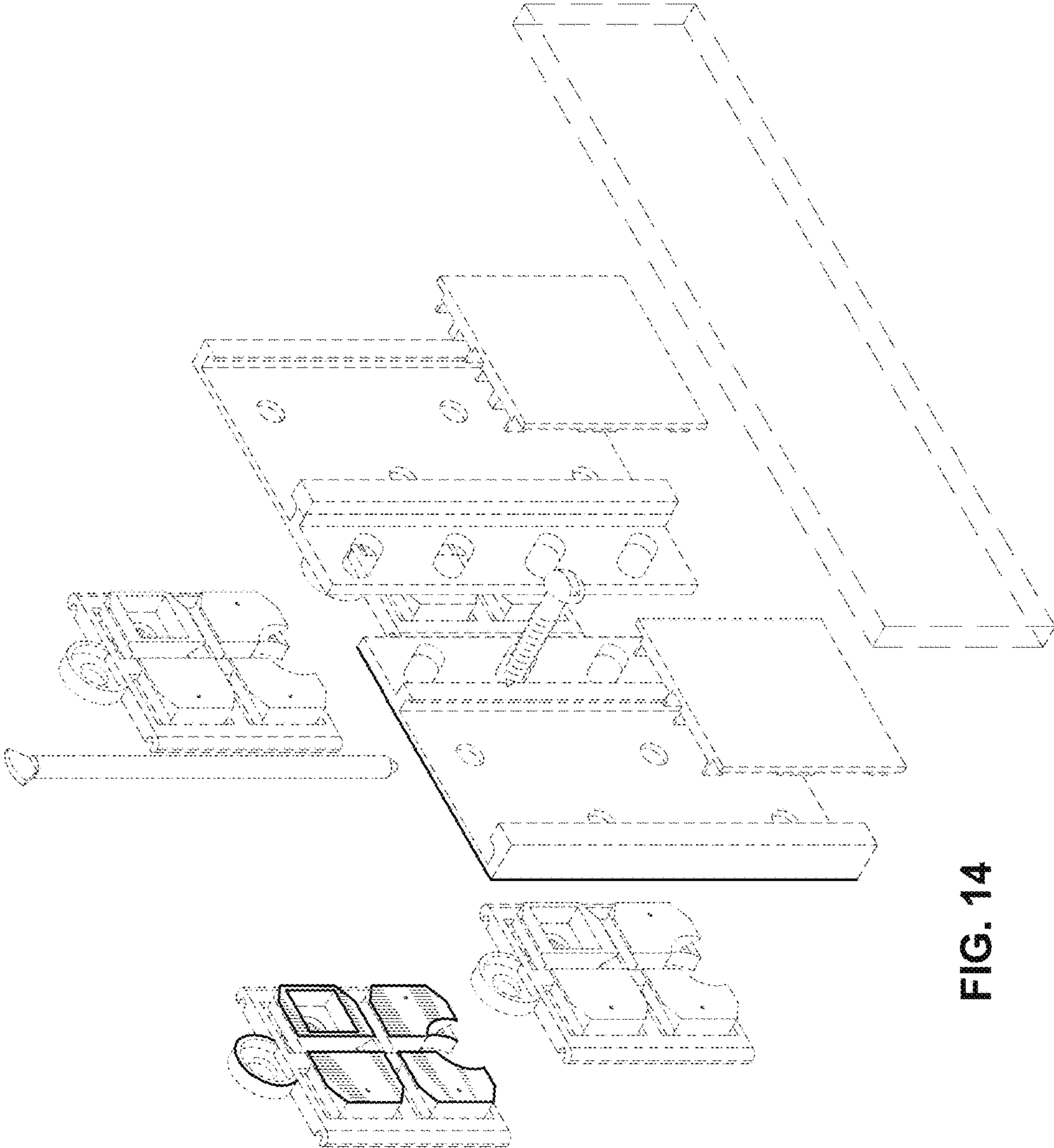

FIG. 14