



US00D848443S

(12) **United States Design Patent** (10) **Patent No.:** **US D848,443 S**  
**Yao et al.** (45) **Date of Patent:** **\*\* \*May 14, 2019**

(54) **PORTABLE DEVICE HOLDER**

6,234,435 B1 5/2001 Yeh  
6,366,672 B1 4/2002 Tsay  
6,441,872 B1 8/2002 Ho

(71) Applicant: **Kenu, Inc.**, San Francisco, CA (US)

(Continued)

(72) Inventors: **David E. Yao**, San Francisco, CA (US);  
**Leonard John Duran**, Mill Valley, CA  
(US); **Gregory D. Caneer**, Oakland,  
CA (US); **Kenneth Y. Minn**, San  
Francisco, CA (US)

FOREIGN PATENT DOCUMENTS

CN 301670390 9/2011  
CN 202907016 U 4/2013

(Continued)

(73) Assignee: **KENU, INC.**, San Francisco, CA (US)

OTHER PUBLICATIONS

(\*) Notice: This patent is subject to a terminal disclaimer.

U.S. Appl. No. 29/607,125, filed Jun. 9, 2017.

(Continued)

(\*\*) Term: **15 Years**

*Primary Examiner* — Angela J Lee

(21) Appl. No.: **29/625,651**

(74) *Attorney, Agent, or Firm* — Vierra Magen Marcus  
LLP

(22) Filed: **Nov. 10, 2017**

(51) **LOC (11) Cl.** ..... **08-07**

(52) **U.S. Cl.**  
USPC ..... **D14/447**

(58) **Field of Classification Search**  
USPC ..... D14/447, 432, 434, 439, 440, 451, 452,  
D14/457, 239, 251, 253; D8/363, 373,  
D8/380; D6/406.3, 406.4, 406.5, 406.6;  
D12/415; D13/108, 144

See application file for complete search history.

(57) **CLAIM**

The ornamental design for a portable device holder, as shown and described.

**DESCRIPTION**

FIG. 1 is a rear perspective view of a portable device holder; FIG. 2 is a front perspective view of the portable device holder; FIG. 3 is a front elevational view of the portable device holder; FIG. 4 is a rear elevational view of the portable device holder; FIG. 5 is a bottom plan view of the portable device holder; FIG. 6 is a top plan view of the the portable device holder; FIG. 7 is a right elevational view of the portable device holder; and, FIG. 8 is a left elevational view of the portable device holder.

(56) **References Cited**

U.S. PATENT DOCUMENTS

2,580,625 A 1/1952 Waltz  
4,797,916 A 1/1989 Kojima  
5,109,411 A 4/1992 O'Connell  
5,305,381 A 4/1994 Wang  
5,338,252 A 8/1994 Bowler et al.  
5,979,724 A 11/1999 Loewenthal et al.  
6,103,201 A 8/2000 Green  
6,149,116 A 11/2000 Won

**1 Claim, 2 Drawing Sheets**

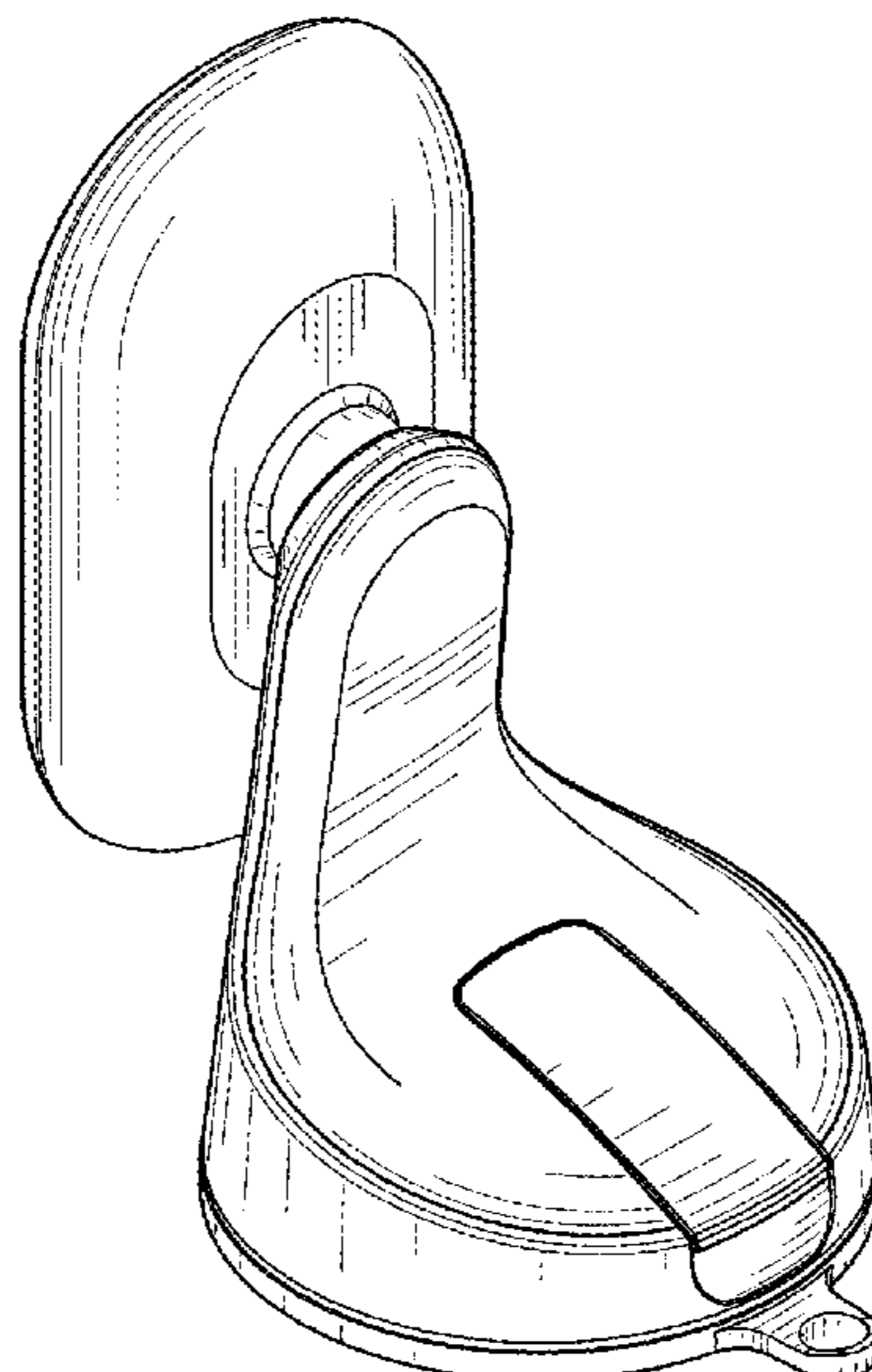

(56)

References Cited

U.S. PATENT DOCUMENTS

D482,039 S 11/2003 Chen et al.  
 D485,340 S 1/2004 Wu  
 6,749,160 B1 6/2004 Richter  
 6,988,907 B2 1/2006 Chang  
 D521,990 S 5/2006 Richter  
 D522,843 S 6/2006 Richter  
 7,061,386 B2 6/2006 Seresini  
 7,066,434 B2 6/2006 Kwok  
 7,080,812 B2 7/2006 Wadsworth  
 7,140,553 B2 11/2006 Zobebe  
 7,178,771 B2 2/2007 Richter  
 D538,912 S 3/2007 Kaplan  
 7,272,984 B2 9/2007 Fan  
 7,284,737 B2 10/2007 Kane  
 D566,590 S 4/2008 Stevens et al.  
 7,475,858 B2 1/2009 Kalis et al.  
 D589,962 S 4/2009 Maruyama et al.  
 7,537,190 B2 5/2009 Fan  
 D603,322 S 11/2009 Nieceja  
 7,628,362 B2 12/2009 Song  
 D607,844 S \* 1/2010 Feldstein ..... D13/168  
 7,661,638 B2 2/2010 Yu  
 D611,478 S 3/2010 Richardson et al.  
 D614,613 S 4/2010 Kim et al.  
 D626,541 S 11/2010 Kim et al.  
 D630,222 S 1/2011 Lin  
 D633,040 S 2/2011 Le et al.  
 7,913,963 B2 3/2011 Cheng et al.  
 D643,407 S 8/2011 Behringer et al.  
 D645,033 S 9/2011 Quong et al.  
 D655,692 S 3/2012 Silverman et al.  
 D656,931 S 4/2012 Wikel  
 D656,940 S 4/2012 McClelland et al.  
 D657,356 S 4/2012 Wikel  
 D657,364 S 4/2012 Norman  
 D663,726 S 7/2012 Gourley  
 D663,735 S 7/2012 Musselman  
 D664,147 S 7/2012 Zhao et al.  
 D670,295 S 11/2012 Prescott et al.  
 D671,950 S 12/2012 Richter  
 8,505,861 B2 8/2013 Carnevali  
 D689,041 S 9/2013 Hampf  
 D690,707 S 10/2013 Minn et al.  
 D692,897 S 11/2013 Luijiben  
 8,706,175 B2 4/2014 Cho  
 8,727,192 B2 5/2014 Lai  
 8,757,461 B2 6/2014 Zanetti  
 D708,187 S \* 7/2014 Xiang ..... D14/447  
 D708,603 S 7/2014 Kim  
 D709,066 S 7/2014 Byun  
 D709,074 S 7/2014 Tsui et al.  
 D713,398 S 9/2014 Alesi et al.  
 D715,790 S 10/2014 Conomos et al.  
 D715,791 S 10/2014 Yu  
 8,857,687 B1 10/2014 An  
 D716,788 S 11/2014 Volkan  
 D717,289 S 11/2014 Takabatake  
 D718,298 S 11/2014 Aspinall et al.  
 D720,759 S 1/2015 Deng et al.  
 D723,311 S 3/2015 Jian et al.  
 D724,072 S 3/2015 Jiang et al.  
 D726,175 S 4/2015 Tsai et al.  
 D727,333 S 4/2015 Shih et al.  
 D733,116 S 6/2015 Aspinall et al.  
 D733,156 S \* 6/2015 Choi ..... D14/447  
 D733,548 S 7/2015 Brown et al.  
 D733,697 S 7/2015 Palan et al.  
 D735,112 S 7/2015 Deng et al.  
 9,080,714 B2 7/2015 Minn et al.  
 D738,873 S 9/2015 Kim et al.  
 D747,704 S 1/2016 Tsou  
 D748,098 S 1/2016 Khodapanah et al.  
 9,267,518 B2 2/2016 Chang  
 D750,515 S 3/2016 Ditges et al.  
 D750,612 S 3/2016 Chen

D750,633 S 3/2016 Minn et al.  
 D757,705 S 5/2016 Esses  
 9,366,383 B2 6/2016 Chien et al.  
 D765,646 S 9/2016 Deng et al.  
 D765,651 S 9/2016 Liu et al.  
 D768,125 S 10/2016 Kim  
 D769,860 S 10/2016 Xiao  
 D772,739 S \* 11/2016 Browning ..... D10/74  
 D774,382 S 12/2016 Richter  
 D778,713 S \* 2/2017 McSweyn ..... D12/415  
 D778,714 S 2/2017 McSweyn et al.  
 D780,168 S 2/2017 Du  
 9,573,531 B2 2/2017 Zhang  
 D782,462 S 3/2017 Huang  
 9,586,530 B2 3/2017 Kim  
 D783,012 S 4/2017 Lee  
 D783,592 S 4/2017 Ju  
 D783,593 S 4/2017 Chen  
 9,611,881 B2 4/2017 Khodapanah et al.  
 D789,920 S 6/2017 Zhang  
 D792,415 S \* 7/2017 Tsai ..... D14/447  
 D792,416 S 7/2017 Tsai  
 9,718,412 B2 8/2017 Minn et al.  
 D796,421 S 9/2017 Huang  
 D799,466 S 10/2017 Sukphist et al.  
 D802,404 S 11/2017 Turksu et al.  
 9,821,724 B2 11/2017 Zhang et al.  
 D825,545 S \* 8/2018 McSweyn ..... D14/253  
 2005/0127538 A1 6/2005 Fabrega  
 2005/0236541 A1 10/2005 Chang  
 2007/0001025 A1 1/2007 Caserta et al.  
 2007/0018064 A1 1/2007 Wang  
 2007/0284500 A1 12/2007 Fan  
 2008/0190978 A1 8/2008 Brassard  
 2008/0224007 A1 9/2008 Mo  
 2009/0060473 A1 3/2009 Kohte et al.  
 2009/0166497 A1 7/2009 Carnevali  
 2010/0019059 A1 1/2010 Bulsink et al.  
 2011/0019992 A1 1/2011 Orf  
 2011/0143583 A1 6/2011 Zilmer et al.  
 2011/0148352 A1 6/2011 Wang et al.  
 2011/0278885 A1 11/2011 Procter et al.  
 2012/0205503 A1 8/2012 Kobal  
 2013/0037590 A1 2/2013 Yoon  
 2014/0097306 A1 4/2014 Hale et al.  
 2014/0103087 A1 4/2014 Fan  
 2014/0138419 A1 5/2014 Minn et al.  
 2014/0176062 A1 6/2014 Jung  
 2014/0265765 A1 9/2014 Khodapanah et al.  
 2015/0072555 A1 3/2015 Riddiford et al.  
 2016/0052370 A1 2/2016 Esses  
 2016/0082893 A1 3/2016 Ormsbee et al.  
 2016/0318455 A1 11/2016 Zhang et al.  
 2016/0347257 A1 12/2016 Buchanan  
 2016/0373152 A1 12/2016 Schmidt  
 2017/0035172 A1 2/2017 Kim  
 2017/0170858 A1 6/2017 Tiller et al.  
 2017/0313259 A1 11/2017 Minn et al.  
 2018/0043840 A1 \* 2/2018 Minn ..... B60R 11/02

FOREIGN PATENT DOCUMENTS

DE 202004007340 U1 7/2004  
 DE 202008010276 U1 11/2008  
 EP 1031446 A1 8/2000  
 EP 1902736 A1 3/2008  
 EP 2835957 4/2015  
 JP 2003054304 A 2/2003  
 JP 3151546 U 6/2009  
 JP 3164223 U 11/2010  
 JP D1415725 5/2011  
 JP D1420793 7/2011  
 JP D1420793 8/2011  
 JP D1453628 10/2012  
 JP D1487823 1/2014  
 KR 10-2000-0044438 7/2000  
 KR 20-0429528 10/2006  
 KR 10-2012-0125933 11/2012  
 KR 30-0941787 1/2018

(56)

**References Cited**

## FOREIGN PATENT DOCUMENTS

TW	D103373	3/2005
TW	D149647	10/2012
TW	D165745	2/2015
TW	D178656	10/2016
WO	WO 9604153	2/1996
WO	WO2004091673 A1	10/2004
WO	D066974-001	9/2005
WO	2010002291 A1	1/2010

## OTHER PUBLICATIONS

U.S. Appl. No. 29/607,126, filed Jun. 9, 2017.  
 U.S. Appl. No. 29/617,062, filed Sep. 11, 2017.  
 U.S. Appl. No. 29/617,064, filed Sep. 11, 2017.  
 U.S. Appl. No. 29/625,650, filed Nov. 10, 2017.  
 U.S. Appl. No. 29/638,301, filed Feb. 26, 2018.  
 U.S. Appl. No. 29/638,303, filed Feb. 26, 2018.  
 Arkon Resources Inc., SMH429-SBH Universal Air Vent Swivel Mount with Adjustable Cradle, (downloaded from <https://www.amazon.com/Arkon-Holder-iPhone-Galaxy-Retail/dp/B003XAF4YQ> on Apr. 11, 2017, 9 pages).  
 Web posting, entitled “[Arkon Air Vent Smartphone Car Mount] Review of SM429-SBH Air Vent Universal Smartphone Car Mount” (Publication Date: Nov. 21, 2010, <http://cafe.naver.com/bjphone/1391925>).  
 Web posting entitled, “Car Mount for Samsung Galaxy S4 Smartphone [Air Vent Smartphone Car Mount]” (Publication Date: Apr. 29, 2013, <http://blog.naver.com/eeleet/130167208063>).  
 China Quality Suppliers; “Black or White Car Air Vent Mount Holder/Adjustable Universal Mobile Phone Stand Holder;” <http://www.hebeimanjikefrp.com/sale-2307306-black-or-white-car-air-vent-mount-holder-adjustable-universal-mobile-phone-stand-holder.html>; Copyright 2014-2015.  
 Exogear; “ExoMount Touch;” <http://www.exogear.com/products-exomount-touch-one-touch-car-mount-holder.html>; Copyright 2013 Exogear.  
 Pearl Automation, Pearl Magnetic Car Phone Mount—Vent or Dashboard Cell Phone Holder for Car or Truck, Publication Date: Sep. 2017 {earliest/exact publication date unknown}, <https://www.amazon.com/Pearl-Magnetic-Car-Phone-Mount/dp/B01M0DNYIV>.  
 Elongdi, Elongdi Air Vent Magnetic Car Mount 360 Degree Rotating Car Phone Mount Holder Compatible with iPhone 6 6S Plus 5 Galaxy S7 S6 edge S5 Sony HTC LG, Publication Date: Sep. 2017 {earliest/exact publication date unknown}, [https://www.amazon.com/gp/product/B01LXY2N6R/ref=oh\\_aui\\_search\\_detailpage?ie=UTF8&psc=1](https://www.amazon.com/gp/product/B01LXY2N6R/ref=oh_aui_search_detailpage?ie=UTF8&psc=1).  
 Mengo, Magnetic Air Vent Car Mount—Aluma Magnetic Phone Holder—Universally Compatible for iPhone Samsung HTC LG Phones—Strong Magnetic Vent Mount, Publication Date: Sep. 2017 {earliest/exact publication date unknown}, [https://www.amazon.com/gp/product/B01IFP01UA/ref=oh\\_aui\\_search\\_detailpage?ie=UTF8&psc=1](https://www.amazon.com/gp/product/B01IFP01UA/ref=oh_aui_search_detailpage?ie=UTF8&psc=1).  
 Iottie, iOttie iTap Magnetic Air Vent Premium Car Mount Holder Cradle for iPhone X 8/8s 7 7 Plus 6s Plus 6s 6 SE Samsung Galaxy S8 Plus S8 Edge S7 S6 Note 8 5, Publication Date: Sep. 2017 {earliest/exact publication date unknown}, [https://www.amazon.com/gp/product/B00Q3G8LPQ/ref=oh\\_aui\\_search\\_detailpage?ie=UTF8&psc=1](https://www.amazon.com/gp/product/B00Q3G8LPQ/ref=oh_aui_search_detailpage?ie=UTF8&psc=1).

Aukey, Aukey Car Mount Air Vent Magnetic Cell Phone Holder for iPhone 7/6S/Plus/Samsung/Mini Tablets and other Android, Windows Smartphones, Publication Date: Sep. 2017 {earliest/exact publication date unknown}, [https://www.amazon.com/gp/product/B01B2R3QNW/ref=oh\\_aui\\_search\\_detailpage?ie=UTF8&psc=1](https://www.amazon.com/gp/product/B01B2R3QNW/ref=oh_aui_search_detailpage?ie=UTF8&psc=1).  
 Scosche, Scosche MAGVM2 MagicMount Vent Mount for Mobile Devices, Publication Date: Sep. 2017 {earliest/exact publication date unknown}, [https://www.amazon.com/gp/product/B00PMOCI72/ref=oh\\_aui\\_search\\_detailpage?ie=UTF8&psc=1](https://www.amazon.com/gp/product/B00PMOCI72/ref=oh_aui_search_detailpage?ie=UTF8&psc=1).  
 Spinido, Spinido Magnetic Car Vent Mount Holder for iPhone 7/6s Plus/iPad mini, Publication Date: Sep. 2017 {earliest/exact publication date unknown}, [https://www.amazon.com/gp/product/B01E58LHWC/ref=oh\\_aui\\_search\\_detailpage?ie=UTF8&psc=1](https://www.amazon.com/gp/product/B01E58LHWC/ref=oh_aui_search_detailpage?ie=UTF8&psc=1).  
 Techmatte, Dashboard Mount TechMatte MagGrip Dashboard and Windshield Magnetic Universal Car Mount Holder for Smartphones including iPhone X, 8, 7, 6, 6S, Galaxy S8, S7, S7 Edge—Black, Publication Date: Sep. 2017 {earliest/exact publication date unknown}, [https://www.amazon.com/Dashboard-TechMatte-Windshield-Universal-Smartphones/dp/B01780KZMW/ref=sr\\_1\\_5?s=wireless&ie=UTF8&qid=1507681675&sr=1-5&keywords=suction+cup+phone+mount](https://www.amazon.com/Dashboard-TechMatte-Windshield-Universal-Smartphones/dp/B01780KZMW/ref=sr_1_5?s=wireless&ie=UTF8&qid=1507681675&sr=1-5&keywords=suction+cup+phone+mount).  
 Scosche, Scosche MAGWSM2 MagicMount Suction Mount for Mobile Devices, Publication Date: Sep. 2017 {earliest/exact publication date unknown}, [https://www.amazon.com/Scosche-MAGWSM2-MagicMount-Suction-Devices/dp/B00R2K4LCY/ref=sr\\_1\\_18?s=wireless&ie=UTF8&qid=1507681675&sr=1-18&keywords=suction+cup+phone+mount](https://www.amazon.com/Scosche-MAGWSM2-MagicMount-Suction-Devices/dp/B00R2K4LCY/ref=sr_1_18?s=wireless&ie=UTF8&qid=1507681675&sr=1-18&keywords=suction+cup+phone+mount).  
 Iottie, Car Mount, iOttie Easy View Universal Car Mount Holder for iPhone 7 6s 5s 5c, Samsung Galaxy S6 Edge Plus S6 S5 S4—Retail Packaging—Black, Publication Date: Sep. 2017 {earliest/exact publication date unknown}, [https://www.amazon.com/iOttie-Universal-Holder-iPhone-Samsung/dp/B00B78MT44/ref=sr\\_1\\_15?s=wireless&ie=UTF8&qid=1507682778&sr=1-15&keywords=iottie](https://www.amazon.com/iOttie-Universal-Holder-iPhone-Samsung/dp/B00B78MT44/ref=sr_1_15?s=wireless&ie=UTF8&qid=1507682778&sr=1-15&keywords=iottie).  
 Ztechworld, Ztechworld Universal Suction Cup Car Mount Mobile Phone Holder for iPhone 7 Plus 6S 6/ Samsung Galaxy S7 S6 Edge Note 3 4 5/ Android Phones and More, Sticky Silicone Base, 360 Rotation, Red Clip, Publication Date: Sep. 2017 {earliest/exact publication date unknown}, [https://www.amazon.com/Ztechworld-Universal-Suction-Silicone-Rotation/dp/B06XGWRX9V/ref=sr\\_1\\_11?s=wireless&ie=UTF8&qid=1507681675&sr=1-11&keywords=suction+cup+phone+mount](https://www.amazon.com/Ztechworld-Universal-Suction-Silicone-Rotation/dp/B06XGWRX9V/ref=sr_1_11?s=wireless&ie=UTF8&qid=1507681675&sr=1-11&keywords=suction+cup+phone+mount).  
 LAX Gadgets, LAX Universal Dashboard-mounted Smart Phone Holder with Non-Slip Grip Bracket—Compatible with Most Smartphones & Mini Tablets—360 Degrees Swivel Mount—Super Stable Suction Cup Car Mount, Publication Date: Sep. 2017 {earliest/exact publication date unknown}, [https://www.amazon.com/LAX-Universal-Dashboard-mounted-Non-Slip-Bracket/dp/B073SKDVLW/ref=sr\\_1\\_43?s=wireless&ie=UTF8&qid=1507681896&sr=1-43&keywords=suction+cup+phone+mount](https://www.amazon.com/LAX-Universal-Dashboard-mounted-Non-Slip-Bracket/dp/B073SKDVLW/ref=sr_1_43?s=wireless&ie=UTF8&qid=1507681896&sr=1-43&keywords=suction+cup+phone+mount).  
 Iottie, iOttie Easy View 2 Car Mount Holder for iPhone 7 7 Plus, 6s Plus 6s 5s 5c, Samsung Galaxy S8 S7 Edge Plus S7 S6, Note 5—Retail Packaging—Black, Publication Date: Sep. 2017 {earliest/exact publication date unknown}, [https://www.amazon.com/iOttie-Holder-Samsung-Retail-Packaging/dp/B00JUXPHWE/ref=sr\\_1\\_13?s=wireless&ie=UTF8&qid=1507682834&sr=1-13&keywords=iottie](https://www.amazon.com/iOttie-Holder-Samsung-Retail-Packaging/dp/B00JUXPHWE/ref=sr_1_13?s=wireless&ie=UTF8&qid=1507682834&sr=1-13&keywords=iottie).  
 Office Action dated Sep. 13, 2018, in U.S. Appl. No. 29/625,650, filed Nov. 10, 2017.  
 U.S. Appl. No. 29/663,050, filed Sep. 11, 2018.

\* cited by examiner

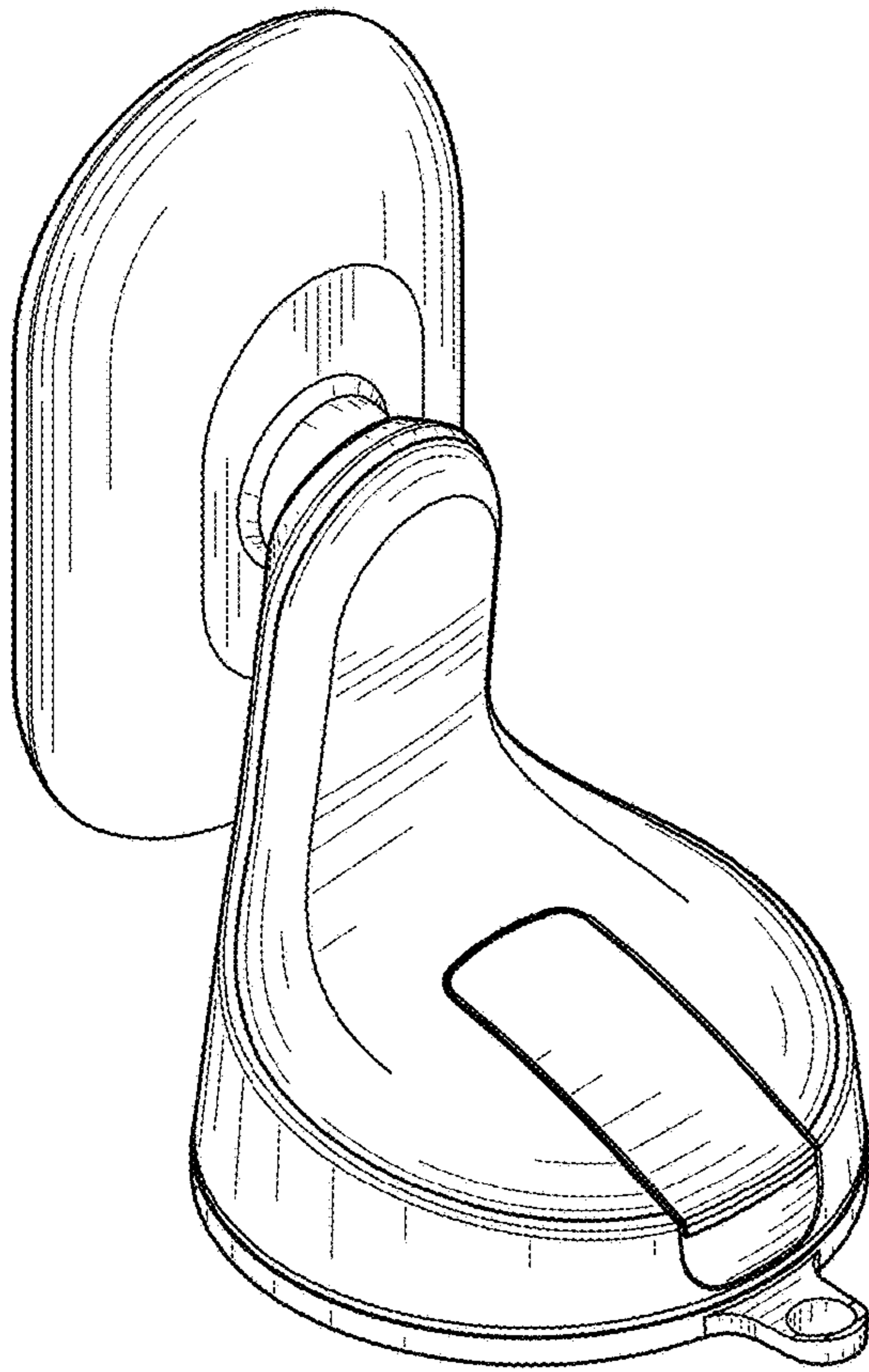

FIG. 1

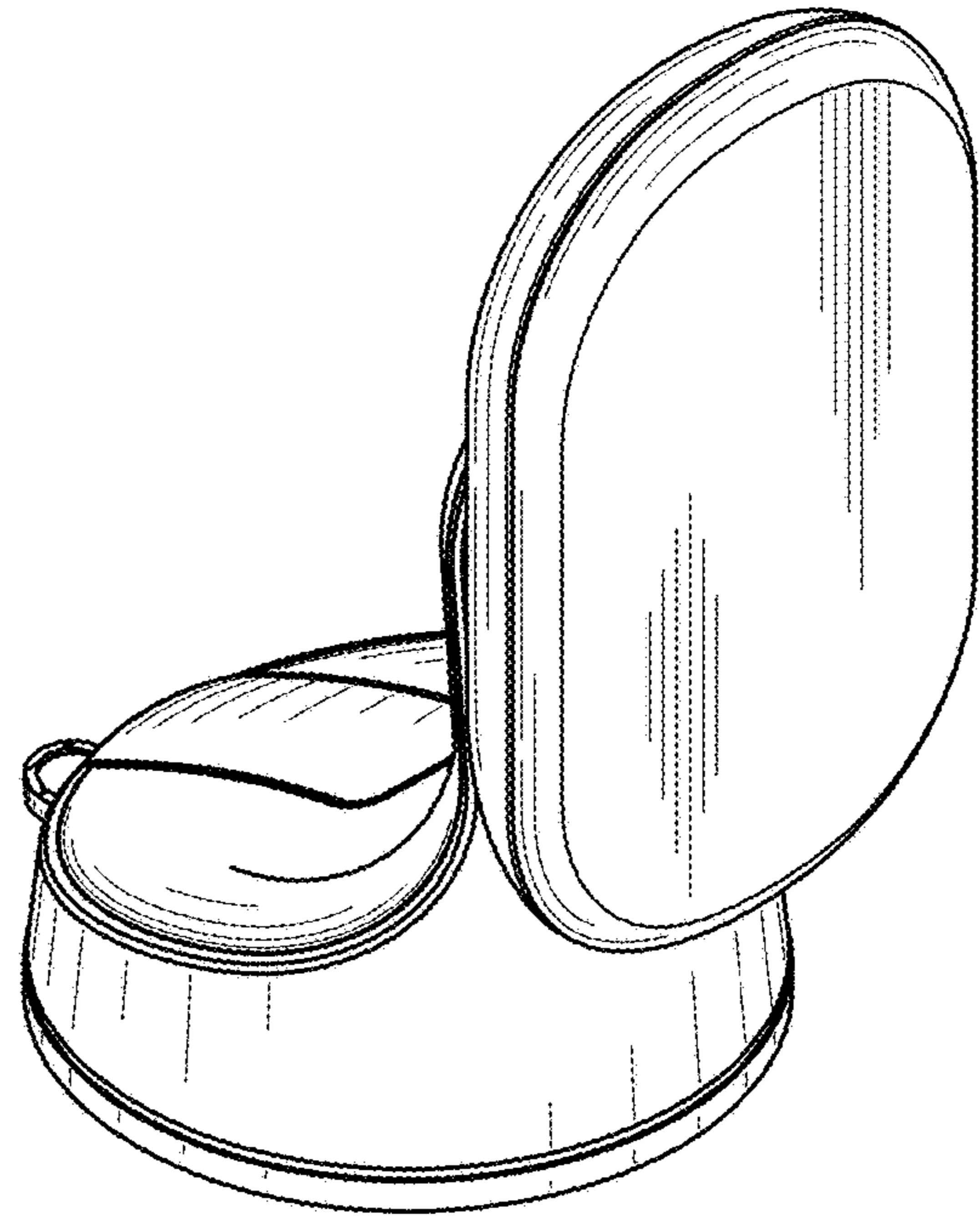

FIG. 2

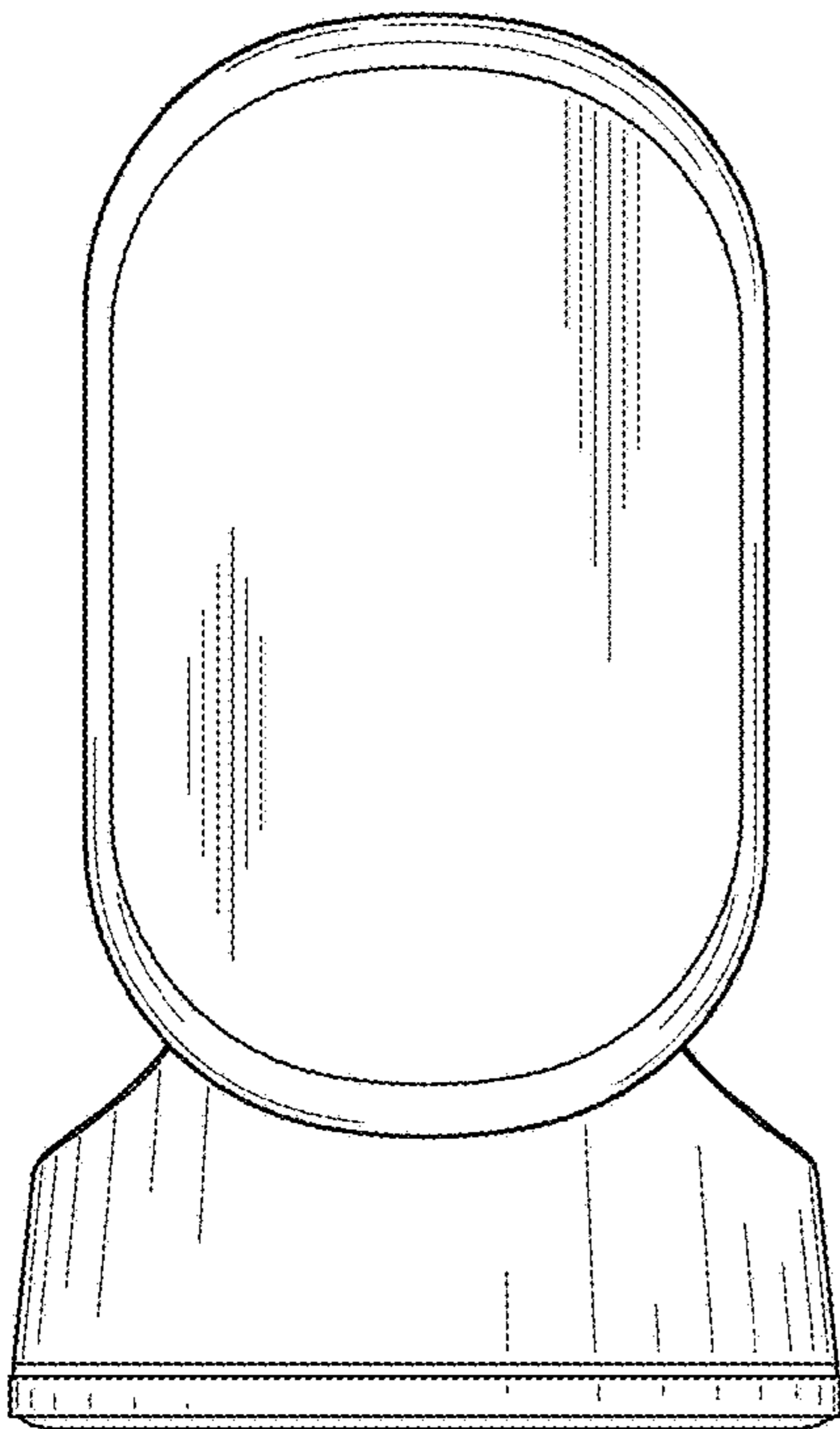

FIG. 3

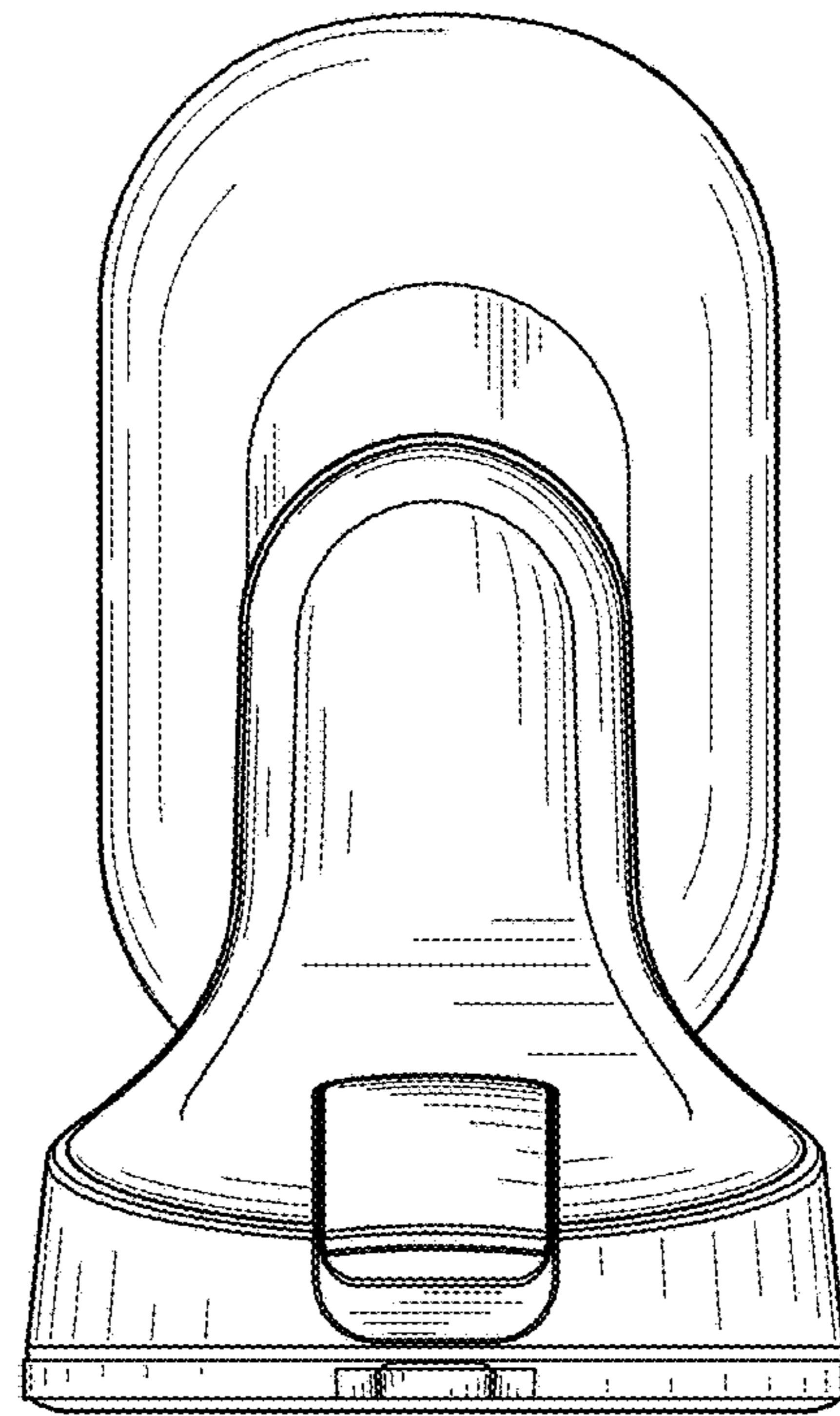

FIG. 4

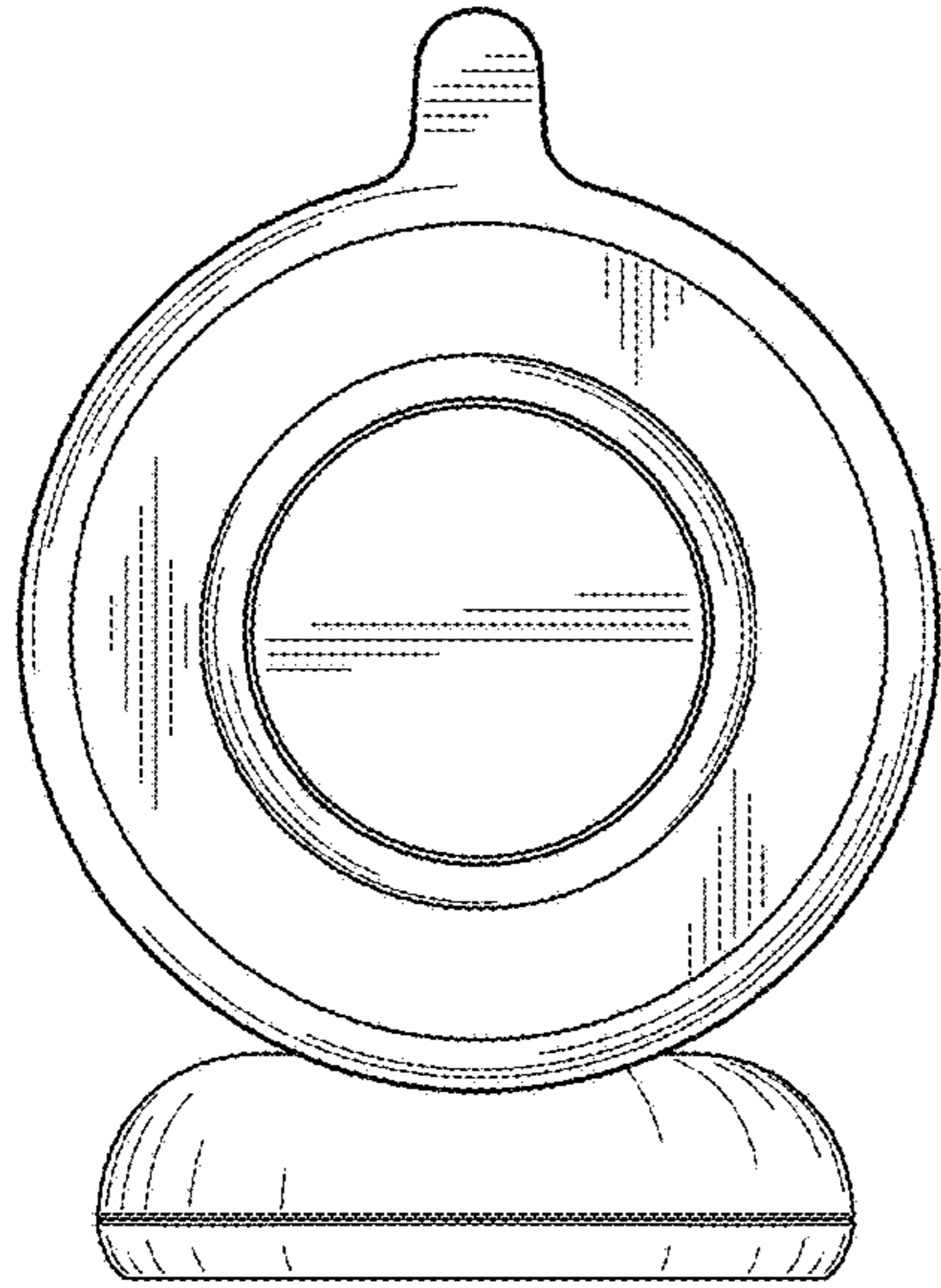

FIG. 5

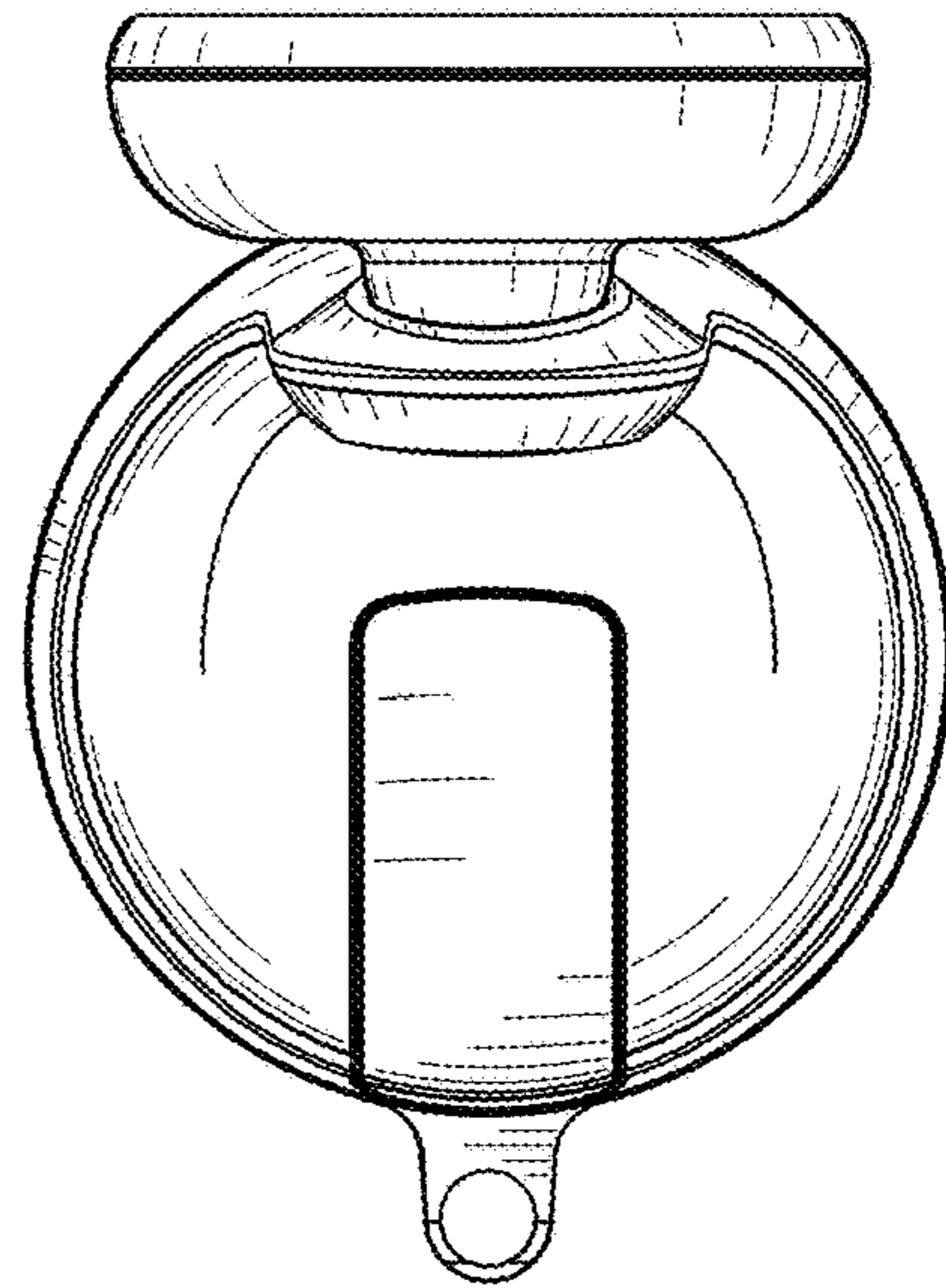

FIG. 6

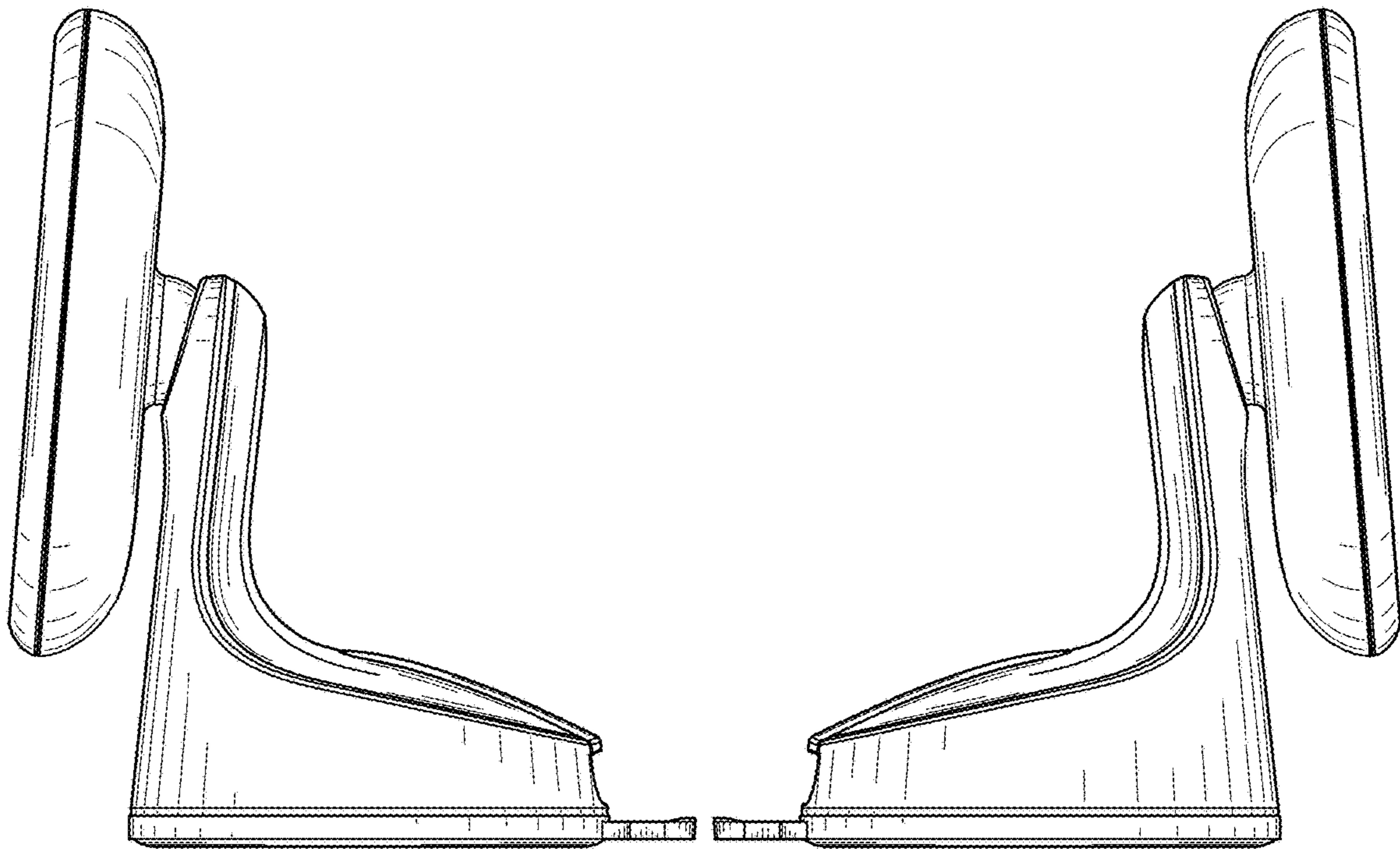

FIG. 7

FIG. 8