



US00D848431S

(12) **United States Design Patent**
Kadonaga

(10) **Patent No.:** **US D848,431 S**

(45) **Date of Patent:** **** May 14, 2019**

(54) **MEMORY CARD**

(71) Applicant: **SONY CORPORATION**, Tokyo (JP)

(72) Inventor: **Akira Kadonaga**, Kanagawa (JP)

(73) Assignee: **SONY CORPORATION**, Tokyo (JP)

(**) Term: **15 Years**

(21) Appl. No.: **29/600,901**

(22) Filed: **Apr. 17, 2017**

Related U.S. Application Data

(63) Continuation-in-part of application No. 29/552,017, filed on Jan. 19, 2016, now Pat. No. Des. 814,473.

(51) **LOC (11) Cl.** **14-02**

(52) **U.S. Cl.**
USPC **D14/436**

(58) **Field of Classification Search**
USPC D14/435-438, 478-480; 235/441, 443, 235/487, 492, 493, 495; 361/737, 679, 361/752, 736, 728, 796, 797, 729, 730, 361/725-727; 257/678, 679, 693, 257/E23.064; 439/946, 948, 159; 174/250, 260, 52.1, 52.2; 710/300-303; 438/121

CPC G06K 19/06196; G06K 19/072; G06K 19/0721; G06K 19/0722; G06K 19/0723; G06K 19/0724; G06K 19/0725; G06K 19/0726; G06K 19/0727; G06K 19/0728; G06K 19/073; G06K 19/07309; G06K 19/077; G06K 19/07701; G06K 19/07715; G06K 19/0772; G06K 19/07722; G06K 19/07724; G06K 19/07726; G06K 19/07728; G06K 19/0773; G06K 19/07735; G06K 19/07737; G06K 19/07739; G06K 19/07741; G06K 19/07743; G06K 19/07745; G06K 19/07747; G06K 19/07749; G06K 19/07758; G06K 19/07767; G06K 19/07769; G06K 19/07771; G06K 19/07773; G06K

19/07775; G06K 19/083; G06K 19/086; G06K 19/145; G06K 19/18; G06K 2215/0022; G06K 2215/0025; G06K 2215/0028; G06K 2215/0031; G06K 2215/004; G06K 2215/0082; G06F 21/86; G06F 21/87; G06F 21/77-21/80; G06F 21/85-21/88; G06F 21/00; G06Q 20/3229; G06Q 20/34; G06Q 20/341; G06Q 20/346; G06Q 20/349; G06Q 20/3563; G06Q 20/3567; G06Q 20/357; G06Q 20/3576; H05K 5/026; H05K 5/0256; H05K 5/0265; H05K 5/0269; H05K 5/0273; H05K 5/0278; H05K 5/0282; H05K 5/0286; H05K 5/0291; H05K 5/0295; H05K 5/03; H05K 5/04; H05K 5/06; H05K 5/061; H05K 5/062; H05K 5/063; H05K 5/064; H05K 5/065; H05K 5/066; H05K 5/067; H05K 5/068; H05K 5/069; H05K 7/00; H05K 7/005; H05K 7/02; H05K 7/023; H05K 7/026; H05K 7/04; H05K 7/10; H05K 7/1418; H05K 7/142; H05K 7/1424; H05K 7/1427-7/1439; H05K 7/1461; H05K 7/1464-7/1474; H05K 7/1479; H05K 7/1481; H05K 7/1485-7/1488; H05K 2201/09745; H05K 2201/09754; H05K 2201/09763; H05K 2201/09772; H05K 2201/098; H05K 2201/09818; H05K 2201/10; H05K 2201/10007; H05K 2201/10098; H05K 2201/10143; H05K 2201/10159; H05K 2201/10174; H05K 2201/10212; H05K 2201/1028; H05K 2201/1031; H05K 2201/10431; H05K 2201/22; H05K 2201/10462; H05K 2201/10545; H05K 2201/10553; H05K 2201/1056; H05K 2201/10621; H05K 2201/10636; H05K 2203/05; H05K 3/368; H05K 3/3436; H05K 3/36; H05K 3/40; H05K 3/4007; H05K 3/4015; H05K 3/403; H05K 3/4053; H05K 3/4092; H05K 3/42; H05K 3/421; H05K 3/46;

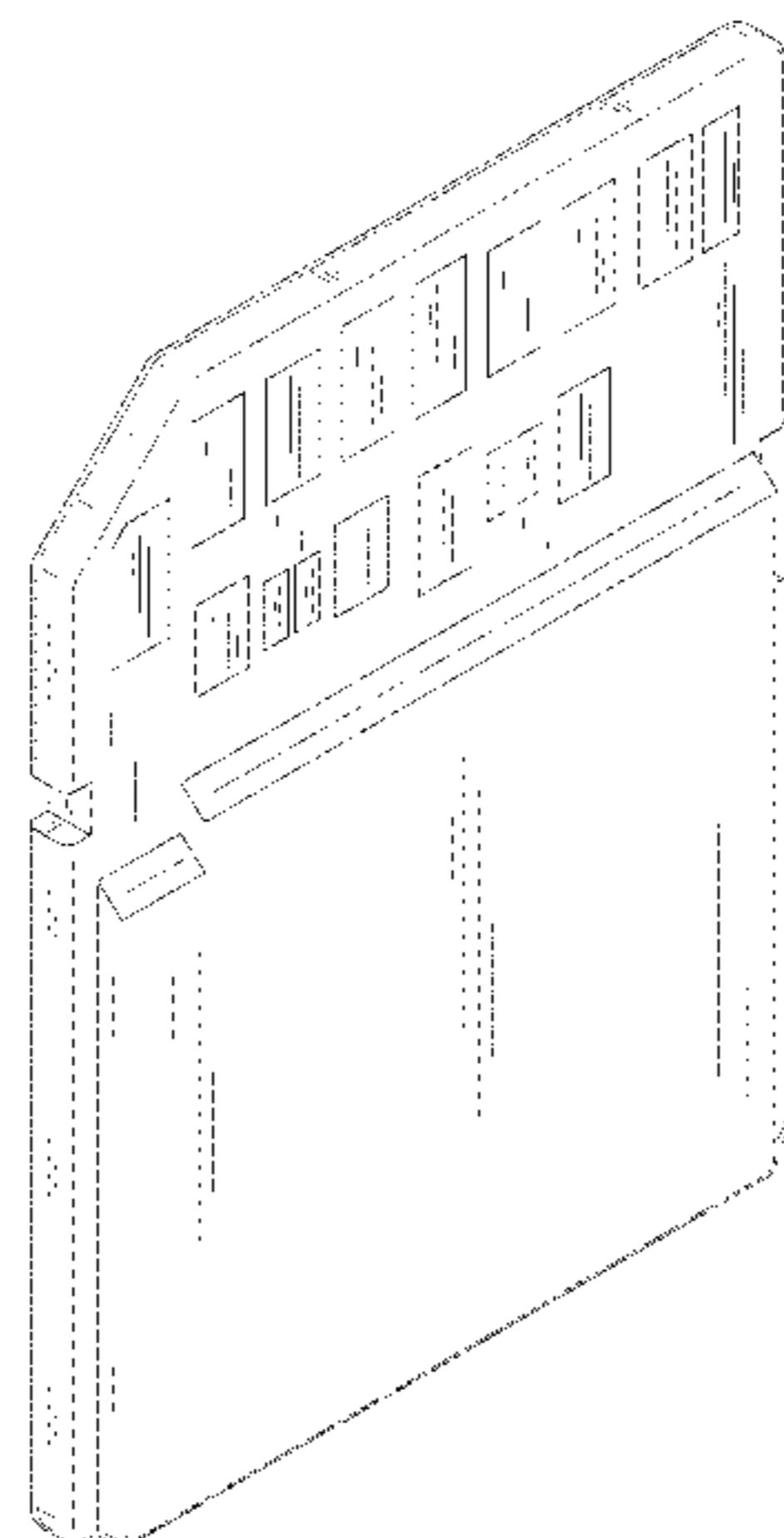

H05K 1/14; H05K 1/141; H05K 1/142;
H05K 1/144; H05K 1/145; H05K 1/182;
H04N 2201/216

See application file for complete search history.

Primary Examiner — Susan Moon Lee
(74) Attorney, Agent, or Firm — Michael Best and
Friedrich LLP

(56) **References Cited**

U.S. PATENT DOCUMENTS

D298,326	S	*	11/1988	Kimura	D14/436
5,242,310	A	*	9/1993	Leung	H05K 5/0269 235/492
5,333,100	A	*	7/1994	Anhalt	G06K 19/077 174/390
5,339,222	A	*	8/1994	Simmons	H05K 5/0269 174/371
D370,904	S	*	6/1996	Nakata	D14/436
D378,085	S	*	2/1997	Kerklaan	D14/436
D410,913	S	*	6/1999	Saito	D14/436
D415,132	S		10/1999	Homma et al.		
D421,597	S		3/2000	Oba et al.		
D421,967	S		3/2000	Oba et al.		
D425,072	S	*	5/2000	Dosch	D14/242
D432,540	S	*	10/2000	Laity	D14/436
D434,042	S	*	11/2000	Yasufuku	D14/436
D435,256	S	*	12/2000	Hibino	D14/435
D452,495	S	*	12/2001	Murnaghan	D14/242
D458,267	S	*	6/2002	Goto	D14/436
D458,935	S	*	6/2002	Hiroki	D14/436
D469,776	S	*	2/2003	Laity	D14/435
D482,025	S	*	11/2003	Laity	D14/242
D502,465	S	*	3/2005	Laity	D14/242
D504,433	S	*	4/2005	Nishizawa	D14/436
D522,520	S	*	6/2006	Hsu	D14/480.6
D523,435	S		6/2006	Takiar et al.		
D525,623	S		7/2006	Takiar et al.		
D525,978	S		8/2006	Takiar et al.		
D537,081	S	*	2/2007	Takiar	D14/436
D563,430	S		3/2008	Deguchi et al.		
D628,202	S	*	11/2010	Pomerantz	D14/436
D638,431	S	*	5/2011	Pomerantz	D14/436
D639,302	S	*	6/2011	Nakamura	D14/436
D642,173	S	*	7/2011	Lee	D14/365
D643,040	S	*	8/2011	Sedio	D14/436
D666,201	S	*	8/2012	Gallagher	D14/435
D681,640	S		5/2013	Aoki et al.		
D689,483	S	*	9/2013	Wu	D14/240
D814,473	S	*	4/2018	Kadonaga	D14/436
2004/0070952	A1	*	4/2004	Higuchi	G06K 19/0719 361/737
2005/0279838	A1	*	12/2005	Wang	G06K 19/077 235/492
2005/0281010	A1	*	12/2005	Wang	H05K 1/117 361/752
2006/0194479	A1	*	8/2006	Osako	G06K 19/07739 439/638
2011/0128207	A1	*	6/2011	Arimura	G06K 19/07743 343/906
2013/0258576	A1	*	10/2013	Ben-Gad	G06K 13/0806 361/679.32
2017/0154003	A1	*	6/2017	Han	G06K 13/08

FOREIGN PATENT DOCUMENTS

CN	302393041	S	4/2013
EM	002269746-0001	S	2/2015
JP	2003-091700	A	3/2003

OTHER PUBLICATIONS

Furumiya, "Today's Goods—Protect Valuable Data from Water! Waterproof SD Card", Ke-tai Watch, Website http://k-tai.watch.impress.co.jp/cda/article/todays_goods/20086.html, Aug. 11, 2004, Impress Corporation, Japan.

* cited by examiner

(57) **CLAIM**

The ornamental design for a memory card, as shown and described.

DESCRIPTION

FIG. 1 is a perspective view of a first embodiment of a memory card showing my new design; FIG. 2 is a front elevational view thereof; FIG. 3 is a rear elevational view thereof; FIG. 4 is a left side elevational view thereof; FIG. 5 is a right side elevational view thereof; FIG. 6 is a top plan view thereof; and FIG. 7 is a bottom plan view thereof. FIG. 8 is an enlarged partial left side elevational view thereof along the lines 8-8 of FIG. 4. FIG. 9 is a perspective view of a second embodiment of a memory card showing my new design; FIG. 10 is a front elevational view thereof; FIG. 11 is a rear elevational view thereof; FIG. 12 is a left side elevational view thereof; FIG. 13 is a right side elevational view thereof; FIG. 14 is a top plan view thereof; and FIG. 15 is a bottom plan view thereof. FIG. 16 is an enlarged partial left side elevational view thereof along the lines 16-16 of FIG. 12. FIG. 17 is a perspective view of a third embodiment of a memory card showing my new design; FIG. 18 is a front elevational view thereof; FIG. 19 is a rear elevational view thereof; FIG. 20 is a left side elevational view thereof; FIG. 21 is a right side elevational view thereof; FIG. 22 is a top plan view thereof; and FIG. 23 is a bottom plan view thereof. FIG. 24 is an enlarged partial left side elevational view thereof along the lines 24-24 of FIG. 20. FIG. 25 is a perspective view of a fourth embodiment of a memory card showing my new design; FIG. 26 is a front elevational view thereof; FIG. 27 is a rear elevational view thereof; FIG. 28 is a left side elevational view thereof; FIG. 29 is a right side elevational view thereof; FIG. 30 is a top plan view thereof; and FIG. 31 is a bottom plan view thereof. FIG. 32 is a partially enlarged left side elevational view thereof along the line 32-32 of FIG. 28. FIG. 33 is a perspective view of a fifth embodiment of a memory card showing my new design; FIG. 34 is a front elevational view thereof; FIG. 35 is a rear elevational view thereof; FIG. 36 is a left side elevational view thereof; FIG. 37 is a right side elevational view thereof; FIG. 38 is a top plan view thereof; and FIG. 39 is a bottom plan view thereof. FIG. 40 is a partially enlarged left side elevational view thereof along the line 40-40 of FIG. 36. FIG. 41 is a perspective view of a sixth embodiment of a memory card showing my new design; FIG. 42 is a front elevational view thereof; FIG. 43 is a rear elevational view thereof; FIG. 44 is a left side elevational view thereof;

FIG. 45 is a right side elevational view thereof;
FIG. 46 is a top plan view thereof; and
FIG. 47 is a bottom plan view thereof.
FIG. 48 is a partially enlarged left side elevational view thereof along the line 48-48 of FIG. 44.
FIG. 49 is a perspective view of a seventh embodiment of a memory card showing my new design;
FIG. 50 is a front elevational view thereof;
FIG. 51 is a rear elevational view thereof;
FIG. 52 is a left side elevational view thereof;
FIG. 53 is a right side elevational view thereof;
FIG. 54 is a top plan view thereof; and
FIG. 55 is a bottom plan view thereof.
FIG. 56 is a partially enlarged left side elevational view thereof along the line 56-56 of FIG. 52.
FIG. 57 is a perspective view of an eighth embodiment of a memory card showing my new design;
FIG. 58 is a front elevational view thereof;
FIG. 59 is a rear elevational view thereof;
FIG. 60 is a left side elevational view thereof;

FIG. 61 is a right side elevational view thereof;
FIG. 62 is a top plan view thereof; and
FIG. 63 is a bottom plan view thereof.
FIG. 64 is a partially enlarged left side elevational view thereof along the line 64-64 of FIG. 60.
FIG. 65 is a perspective view of a ninth embodiment of a memory card showing my new design;
FIG. 66 is a front elevational view thereof;
FIG. 67 is a rear elevational view thereof;
FIG. 68 is a left side elevational view thereof;
FIG. 69 is a right side elevational view thereof;
FIG. 70 is a top plan view thereof; and
FIG. 71 is a bottom plan view thereof.
The even-dash broken lines illustrating a portion of the memory card form no part of the claimed design. Dot-dash broken lines showing of a part of the memory card define the boundaries of the claimed design and are not included in the claimed design.

1 Claim, 36 Drawing Sheets

FIG.1

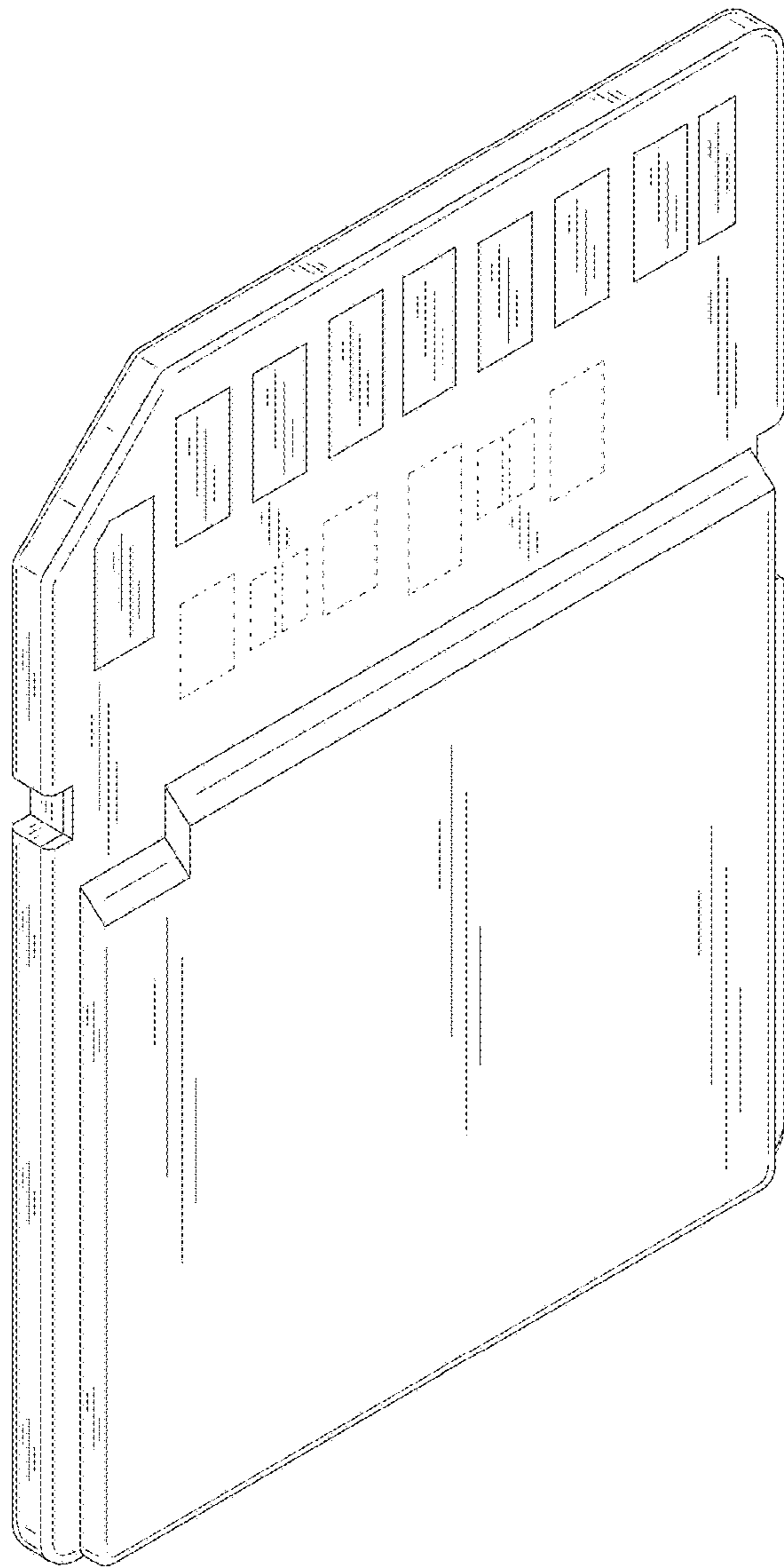

FIG.8

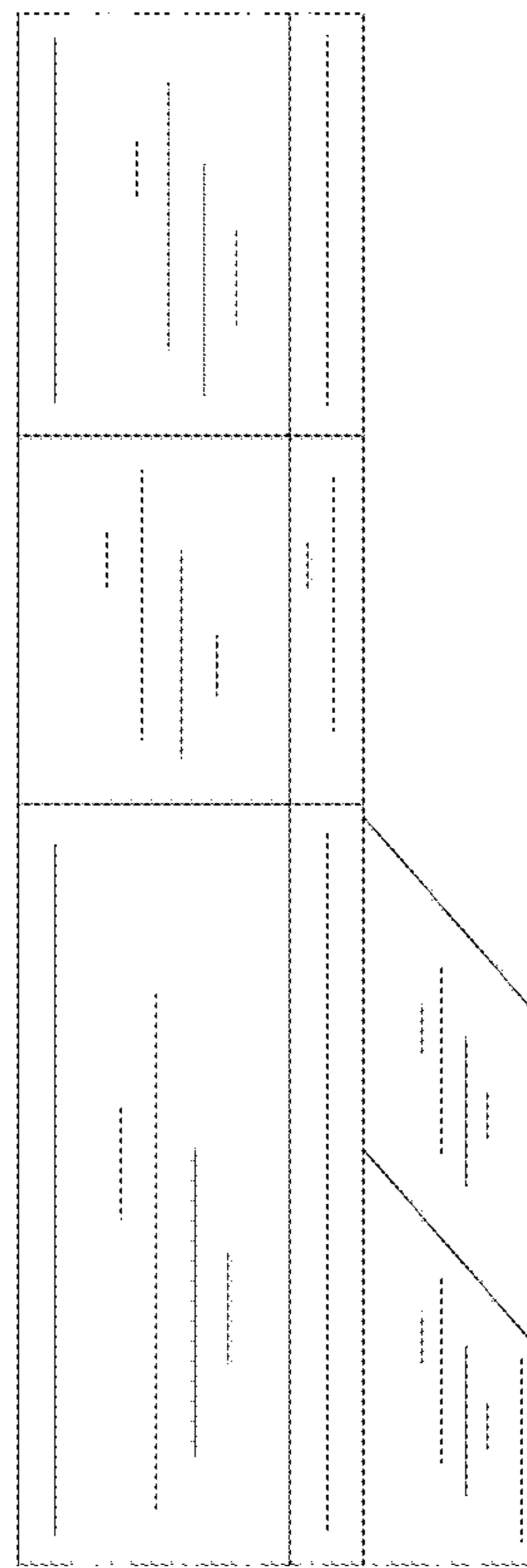

FIG.2

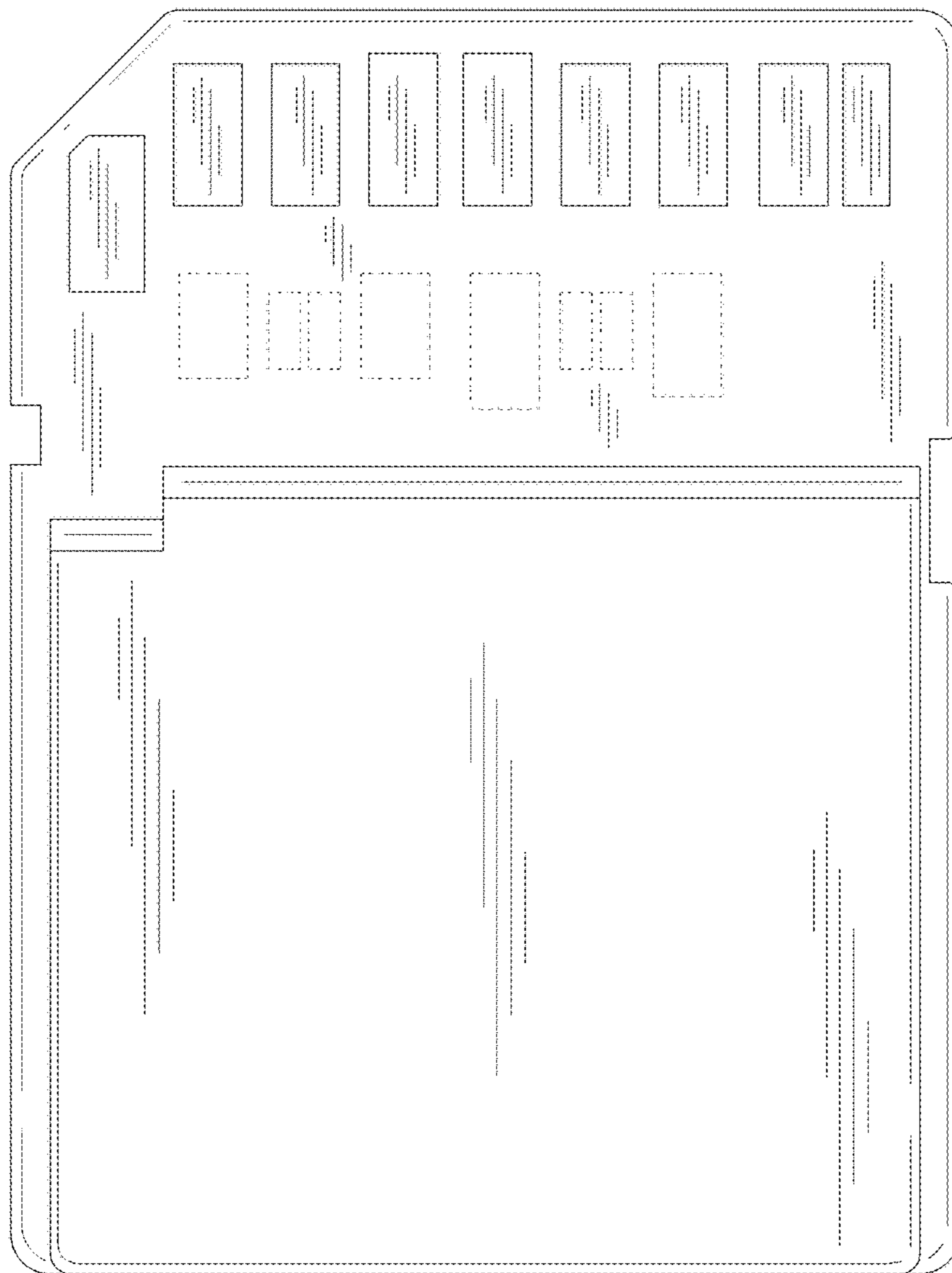

FIG.3

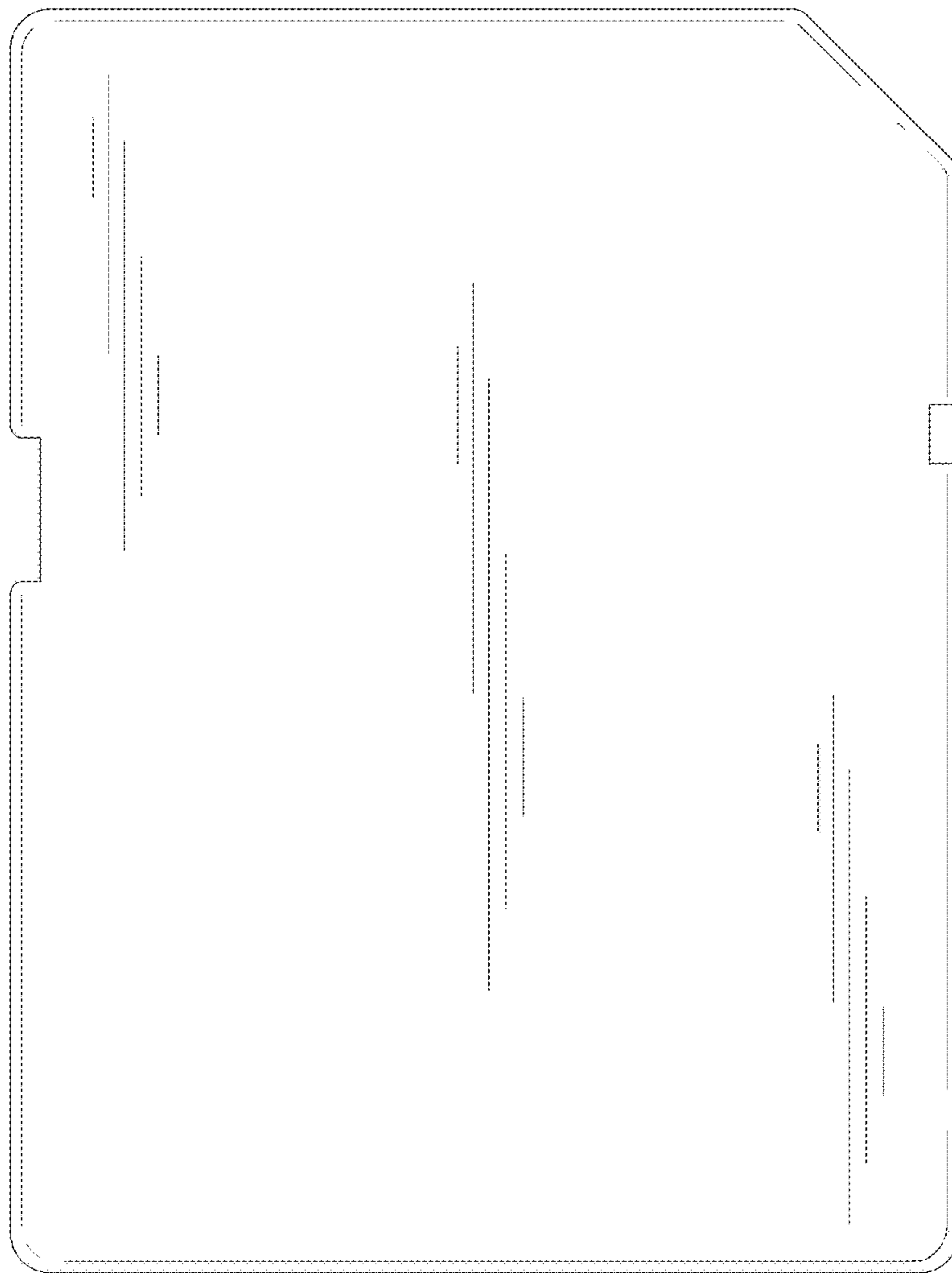

FIG.4

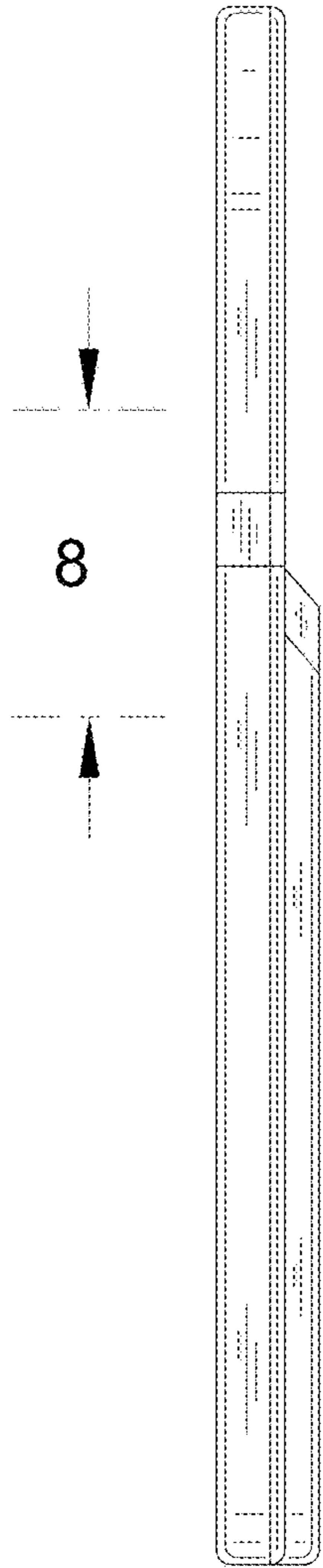

FIG.5

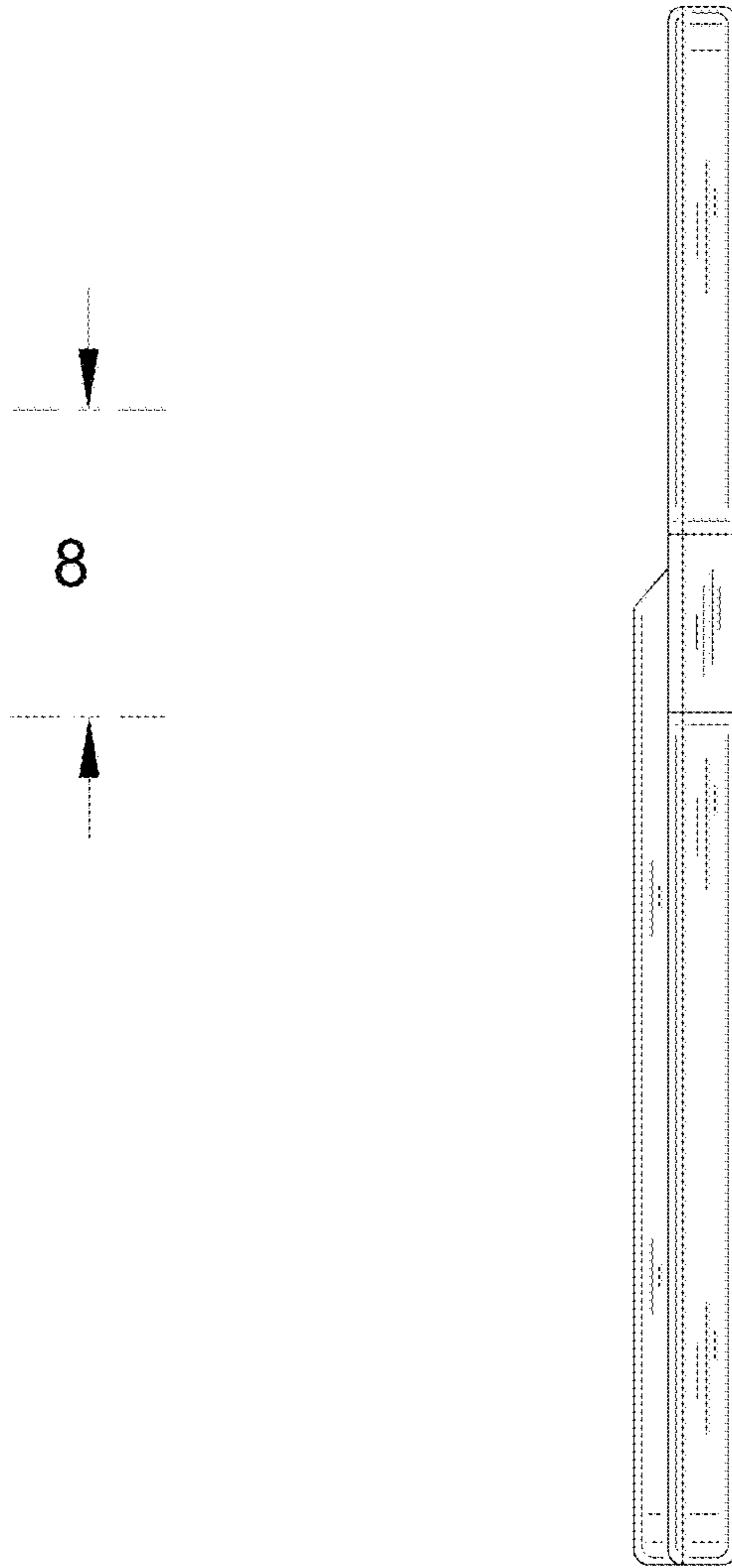

FIG.6

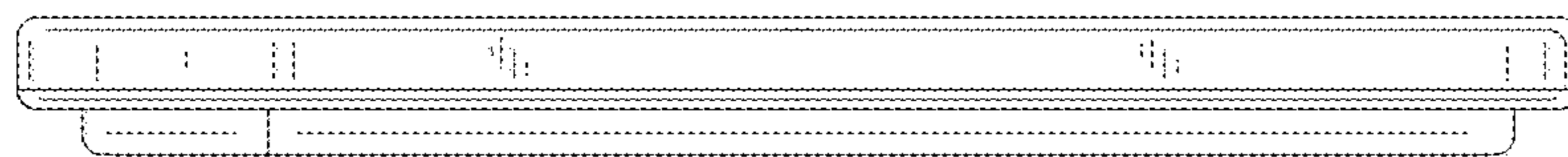

FIG.7

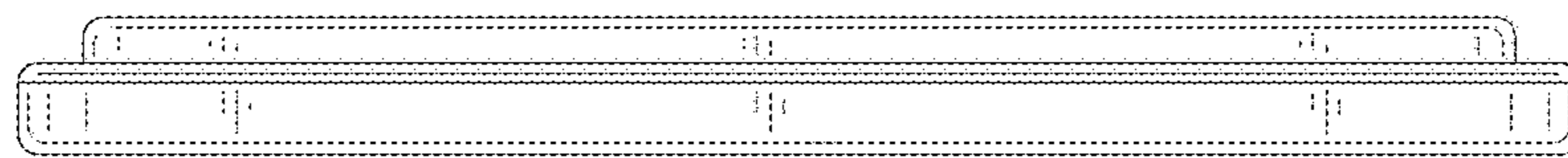

FIG.9

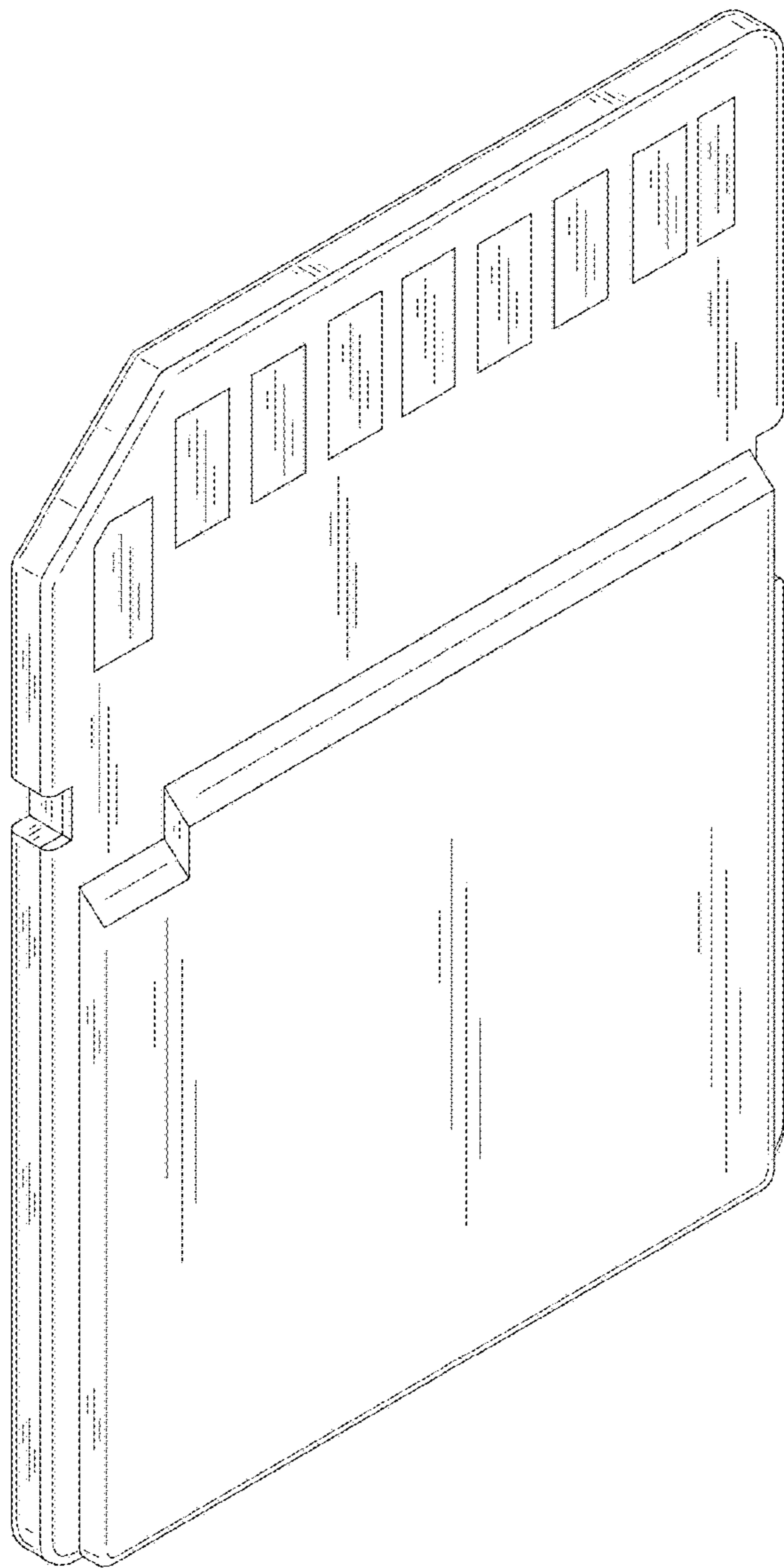

FIG.16

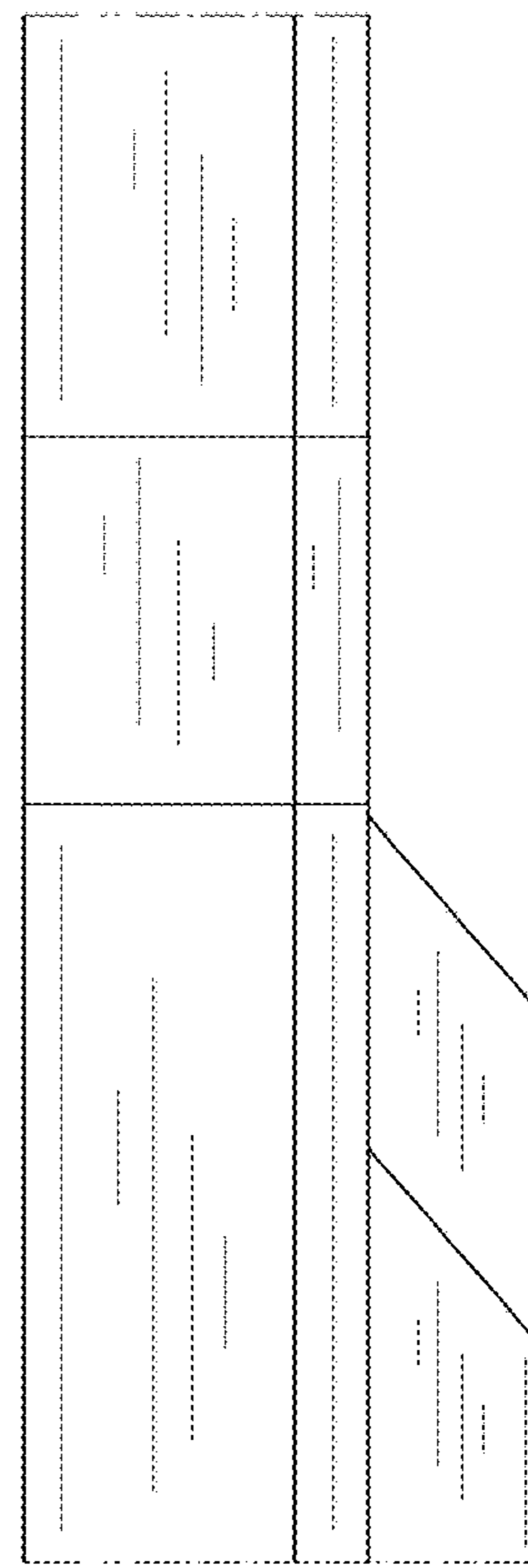

FIG.10

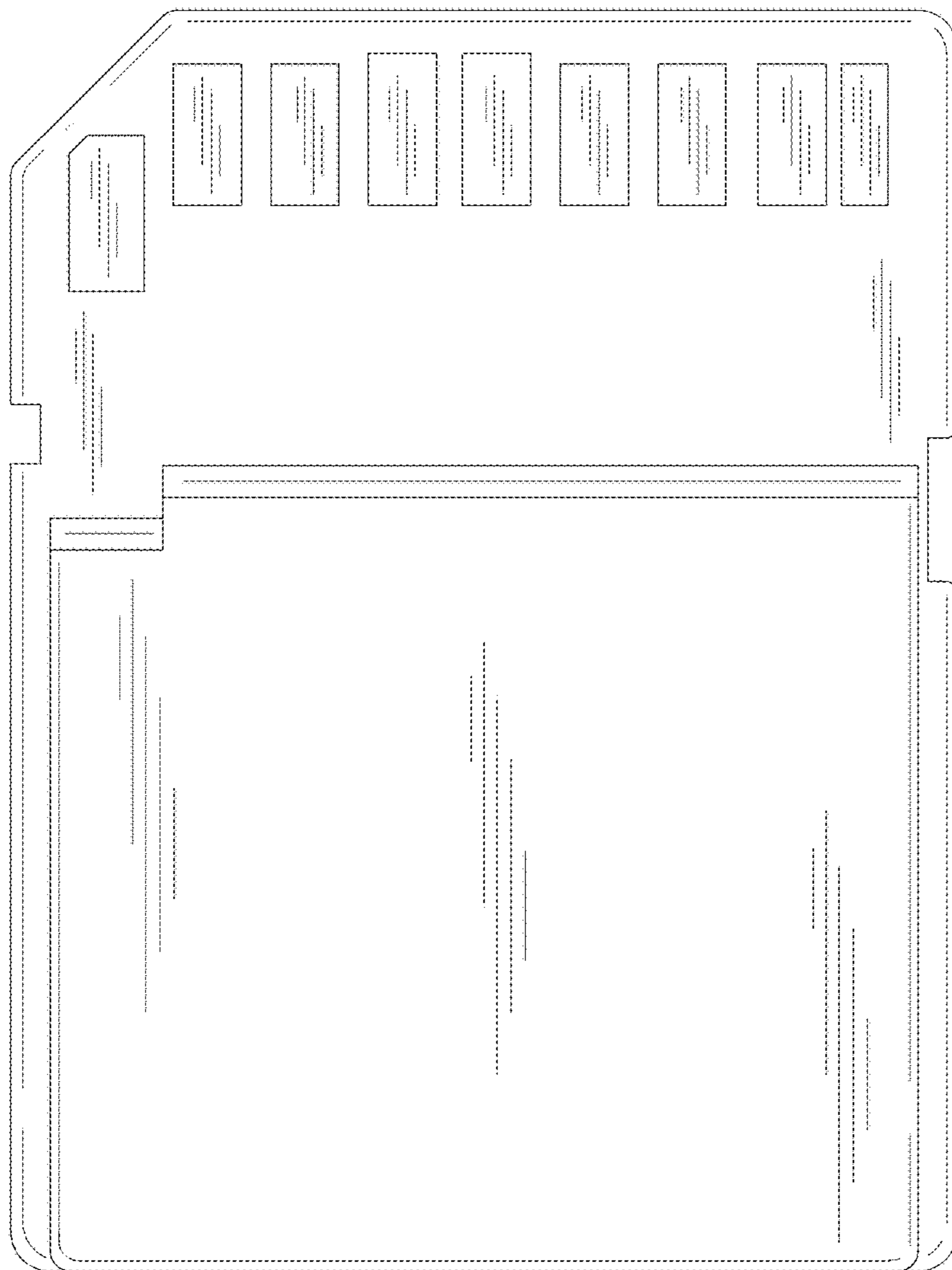

FIG. 11

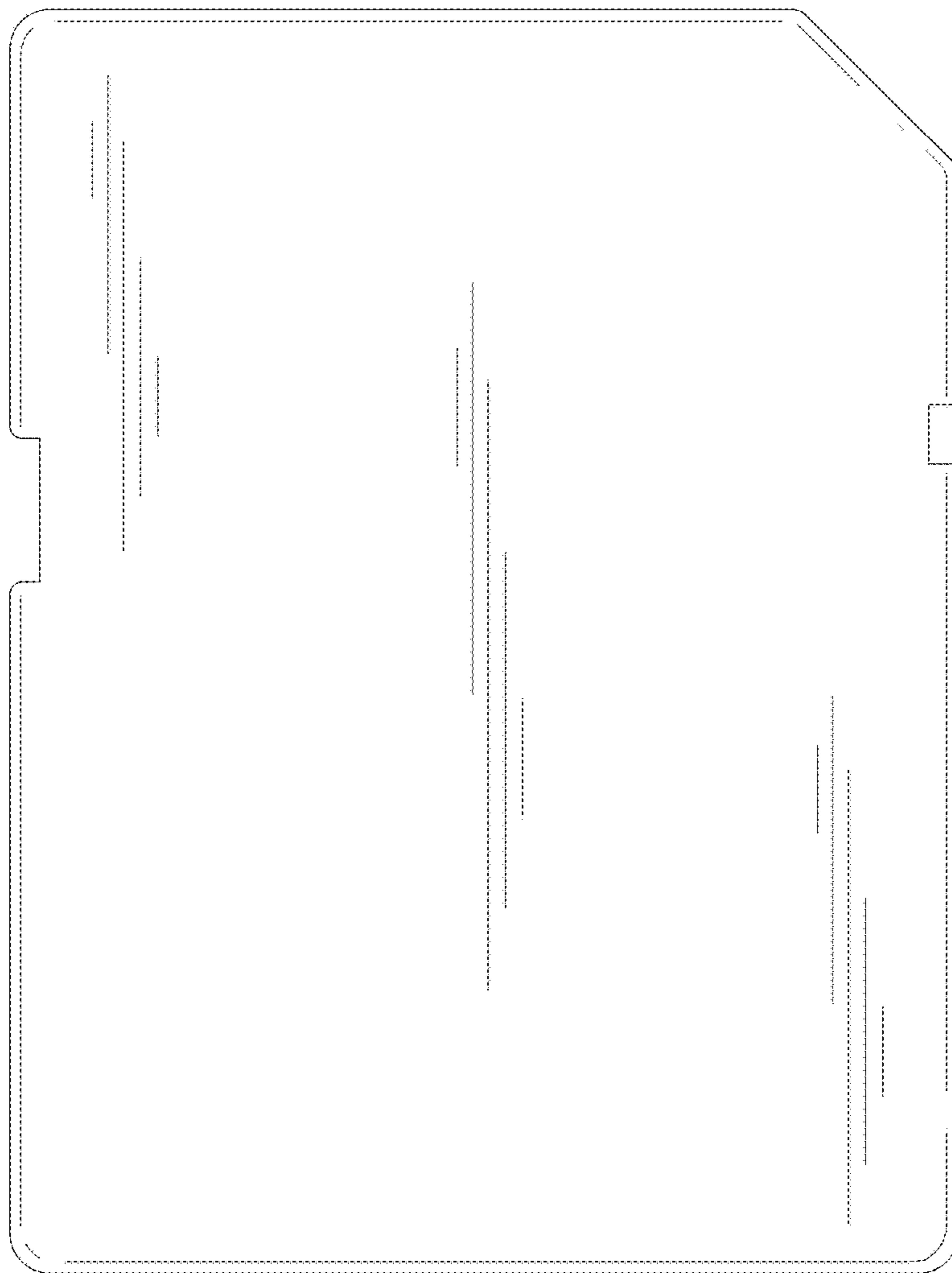

FIG.12

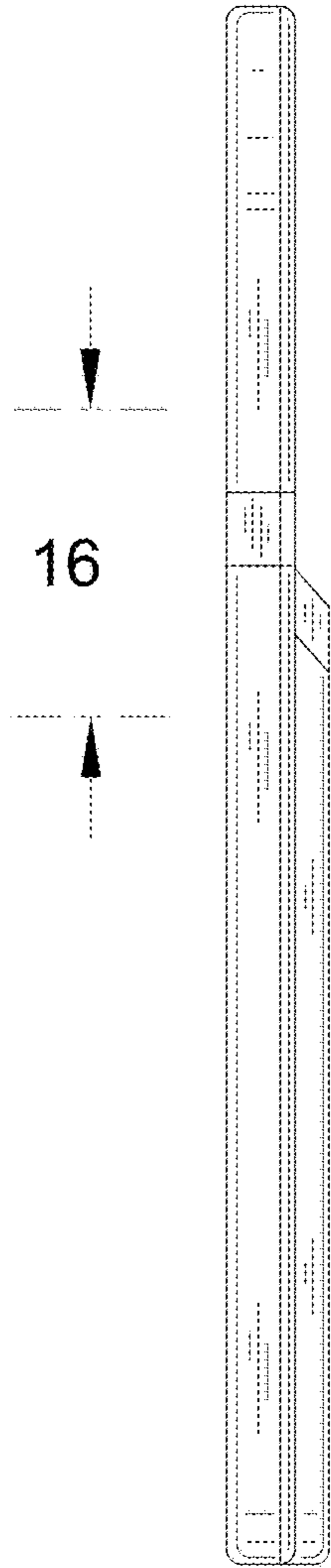

FIG.13

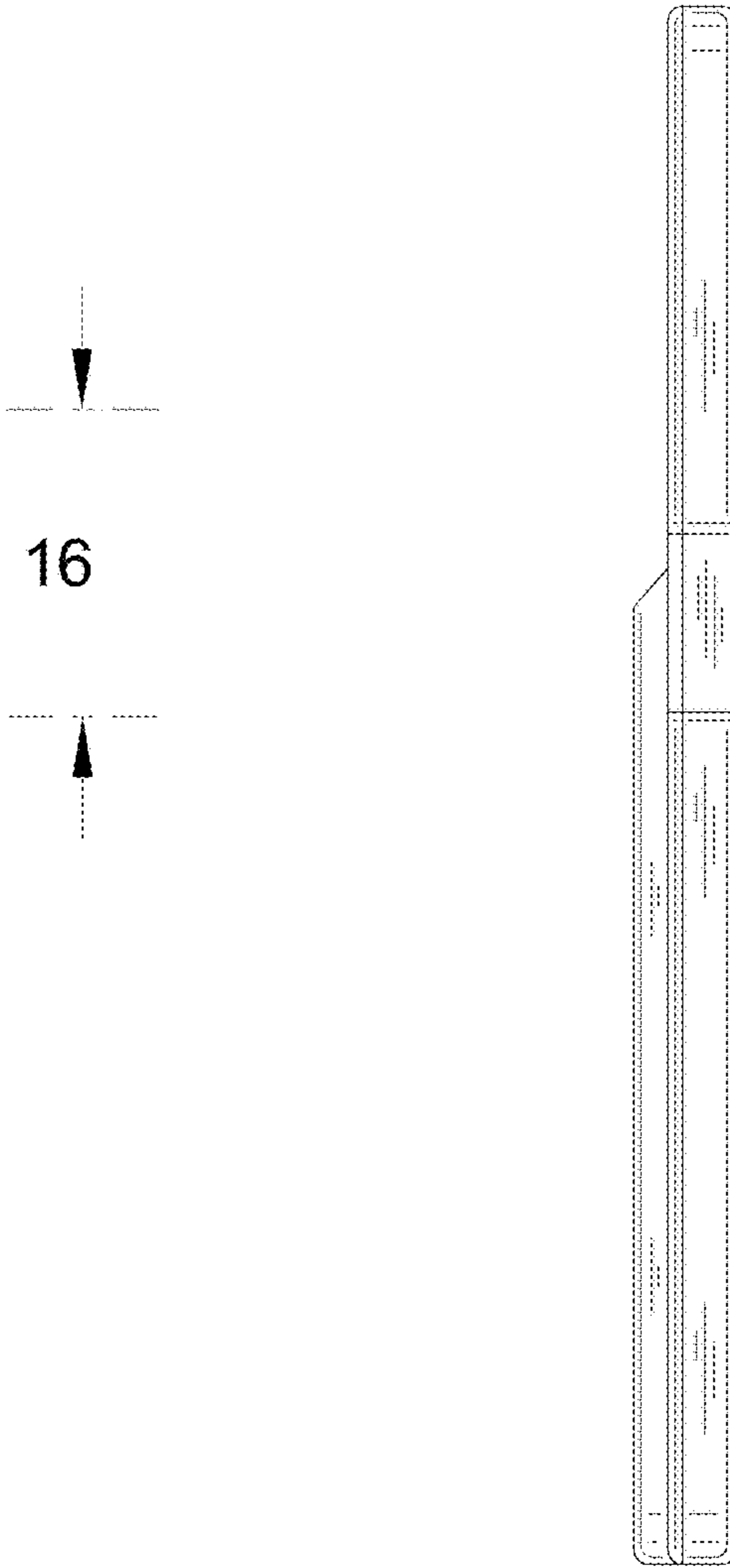

FIG.14

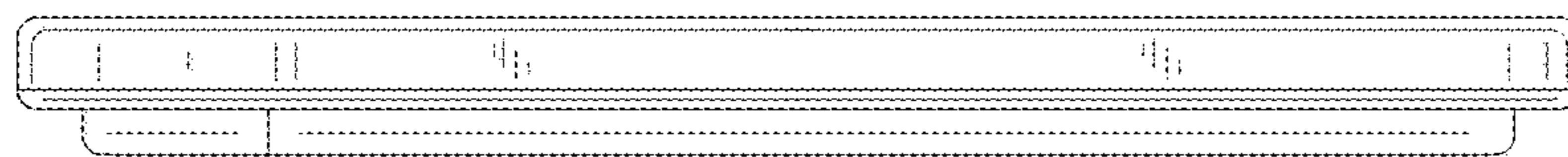

FIG.15

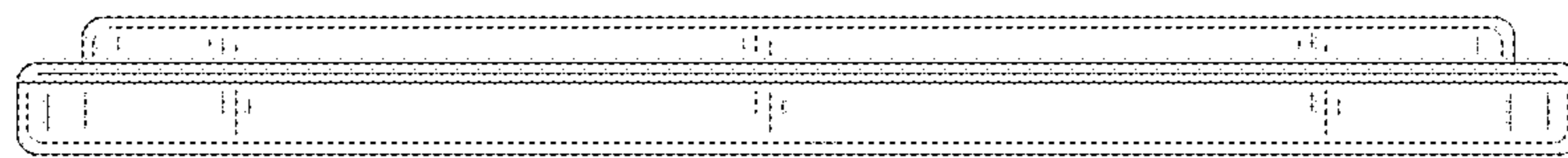

FIG.17

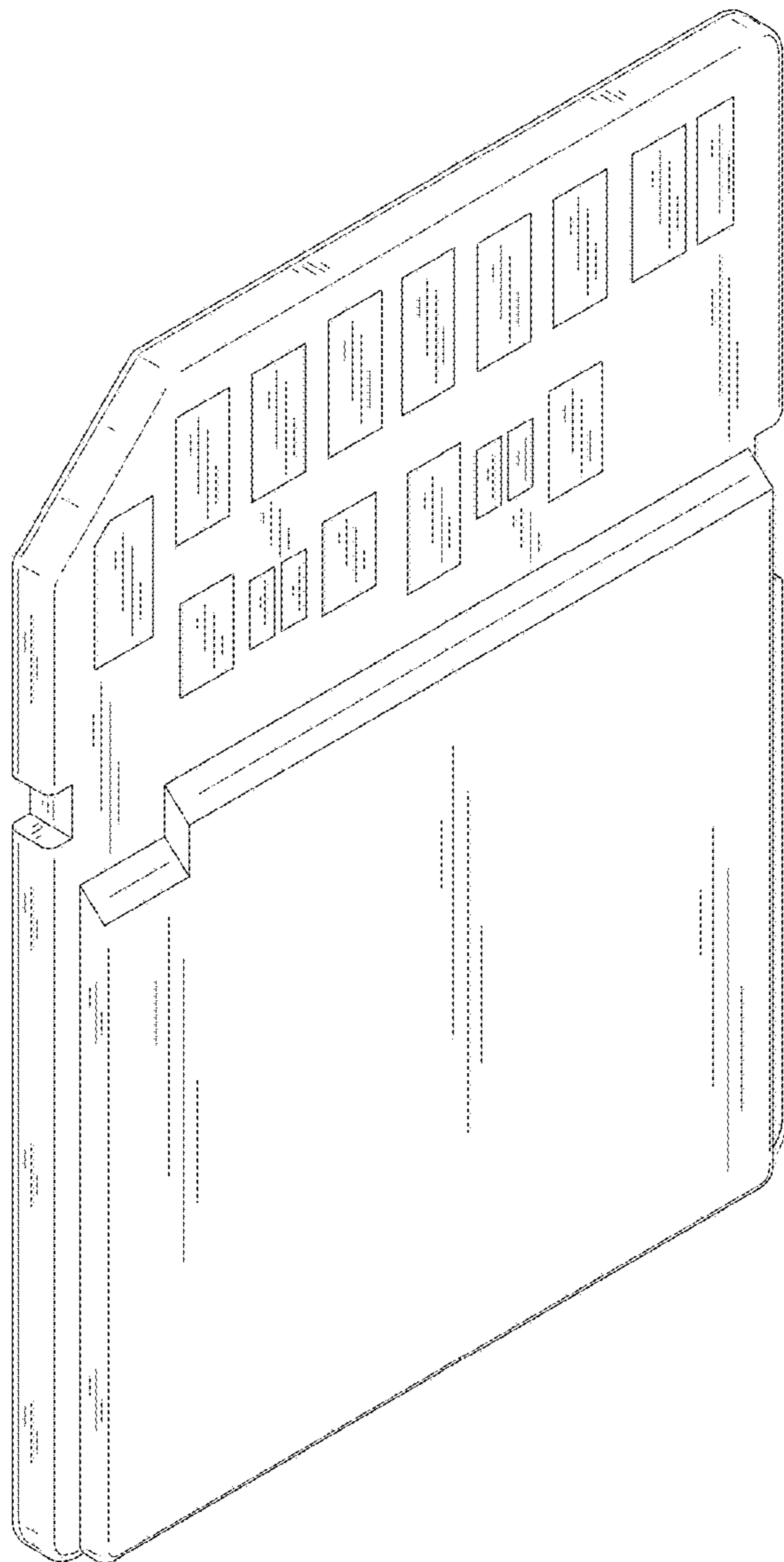

FIG.24

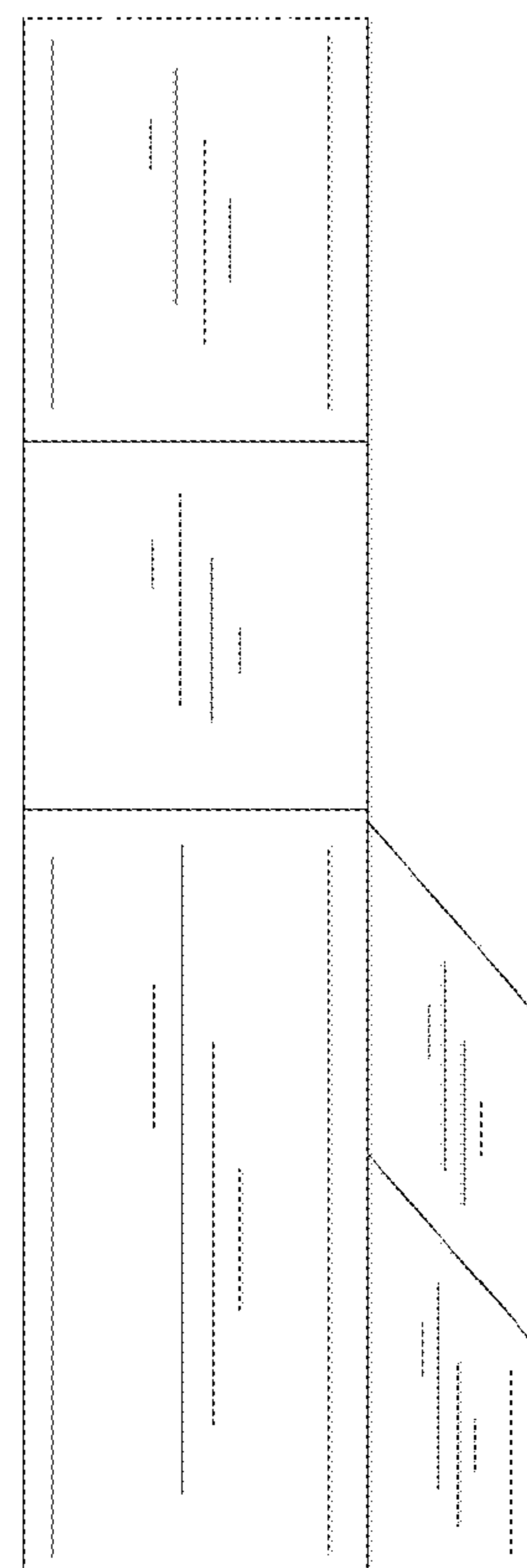

FIG. 18

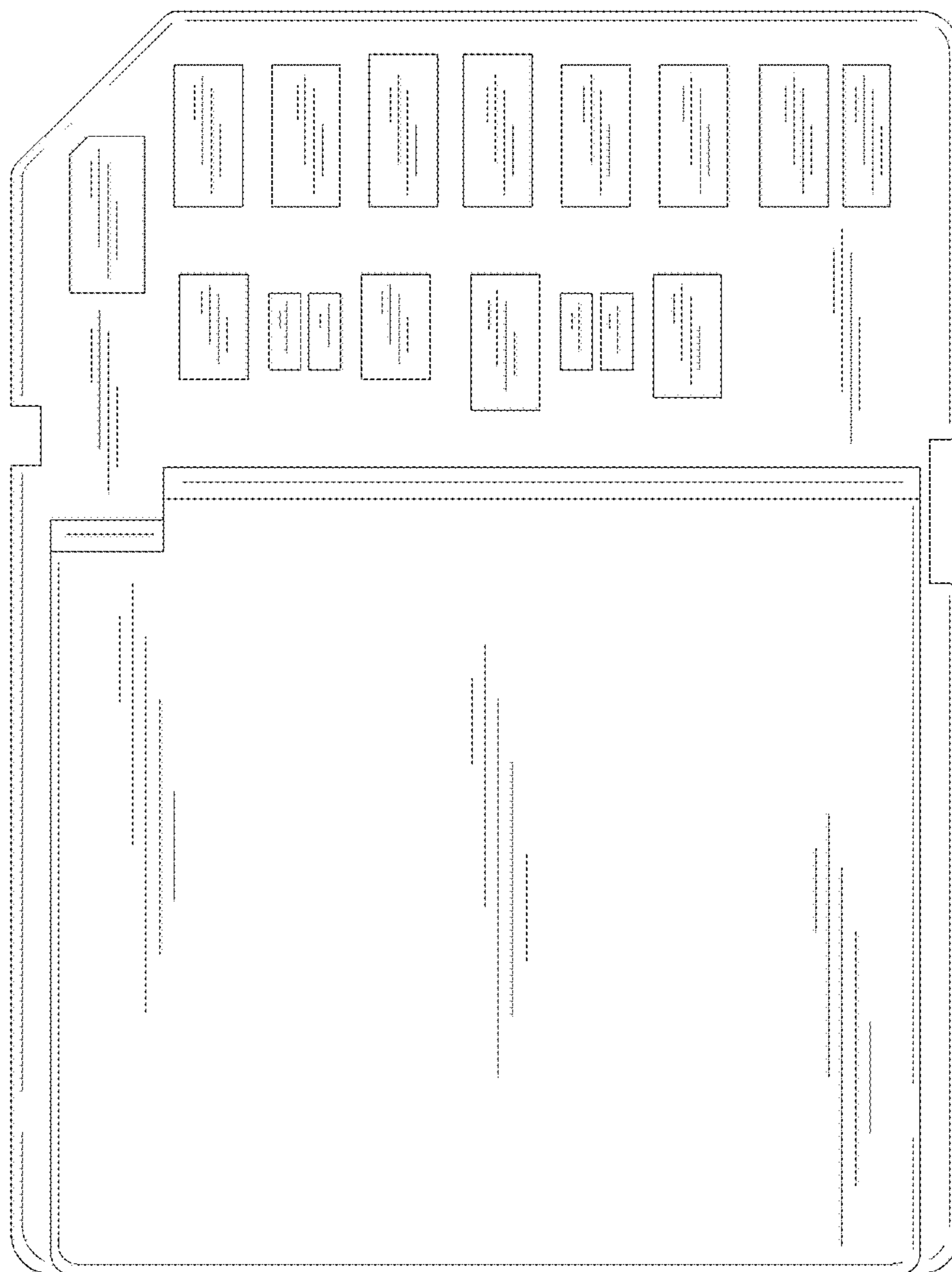

FIG.19



FIG.20

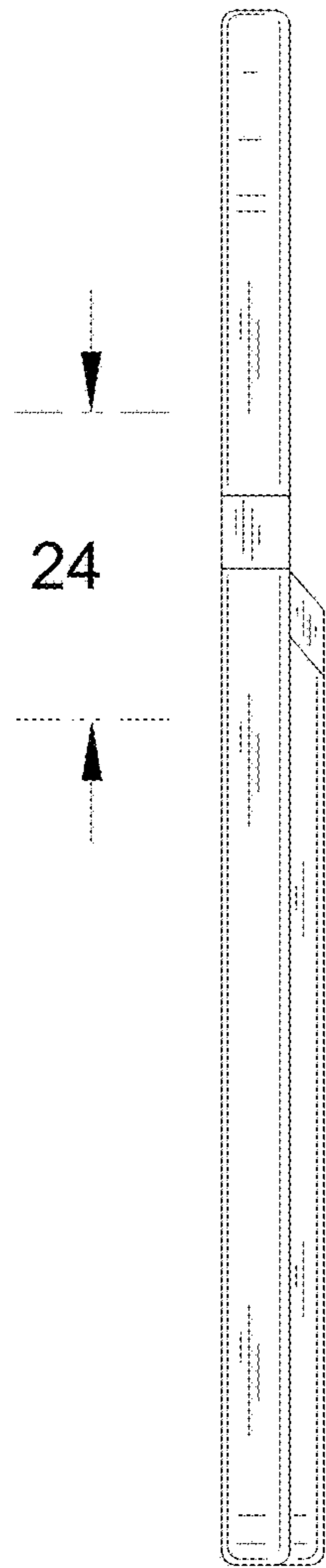

FIG.21

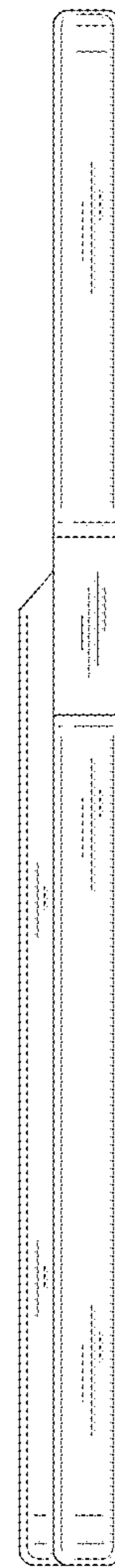

FIG.22

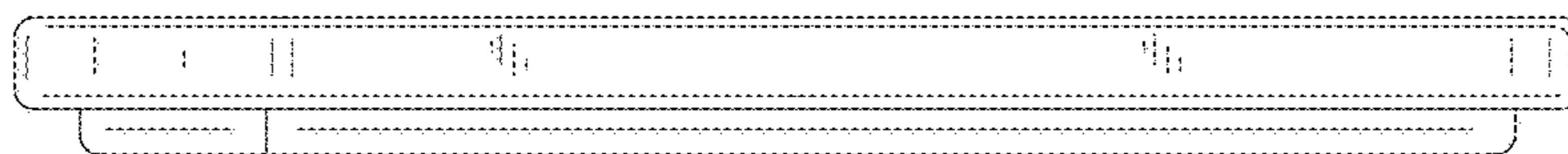

FIG.23



FIG.25

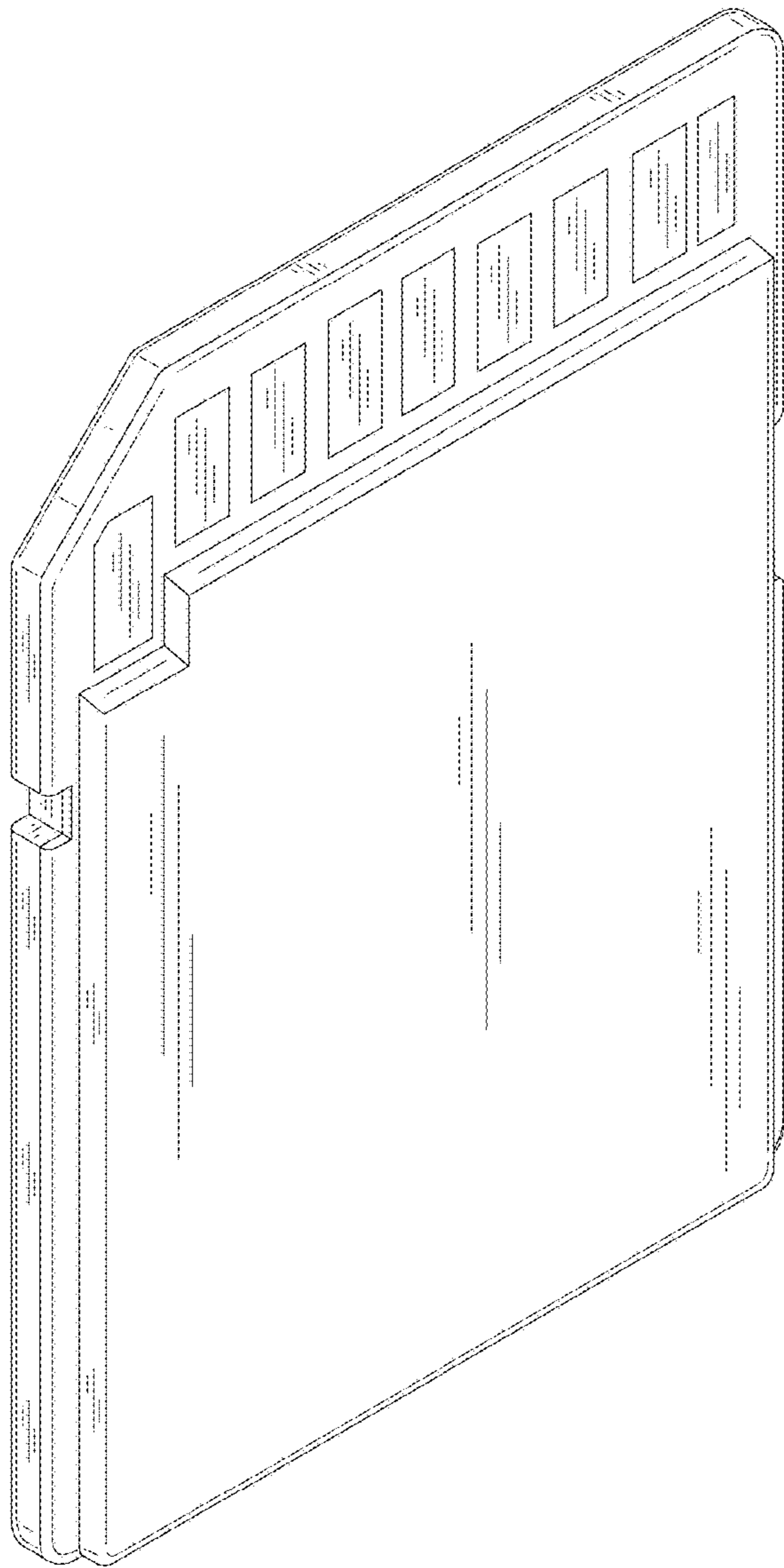

FIG.32

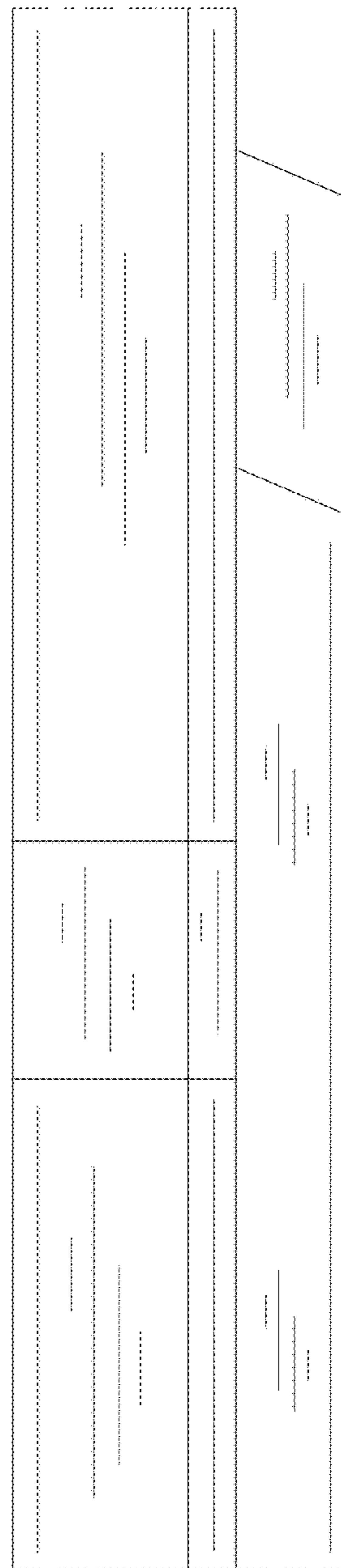

FIG.26

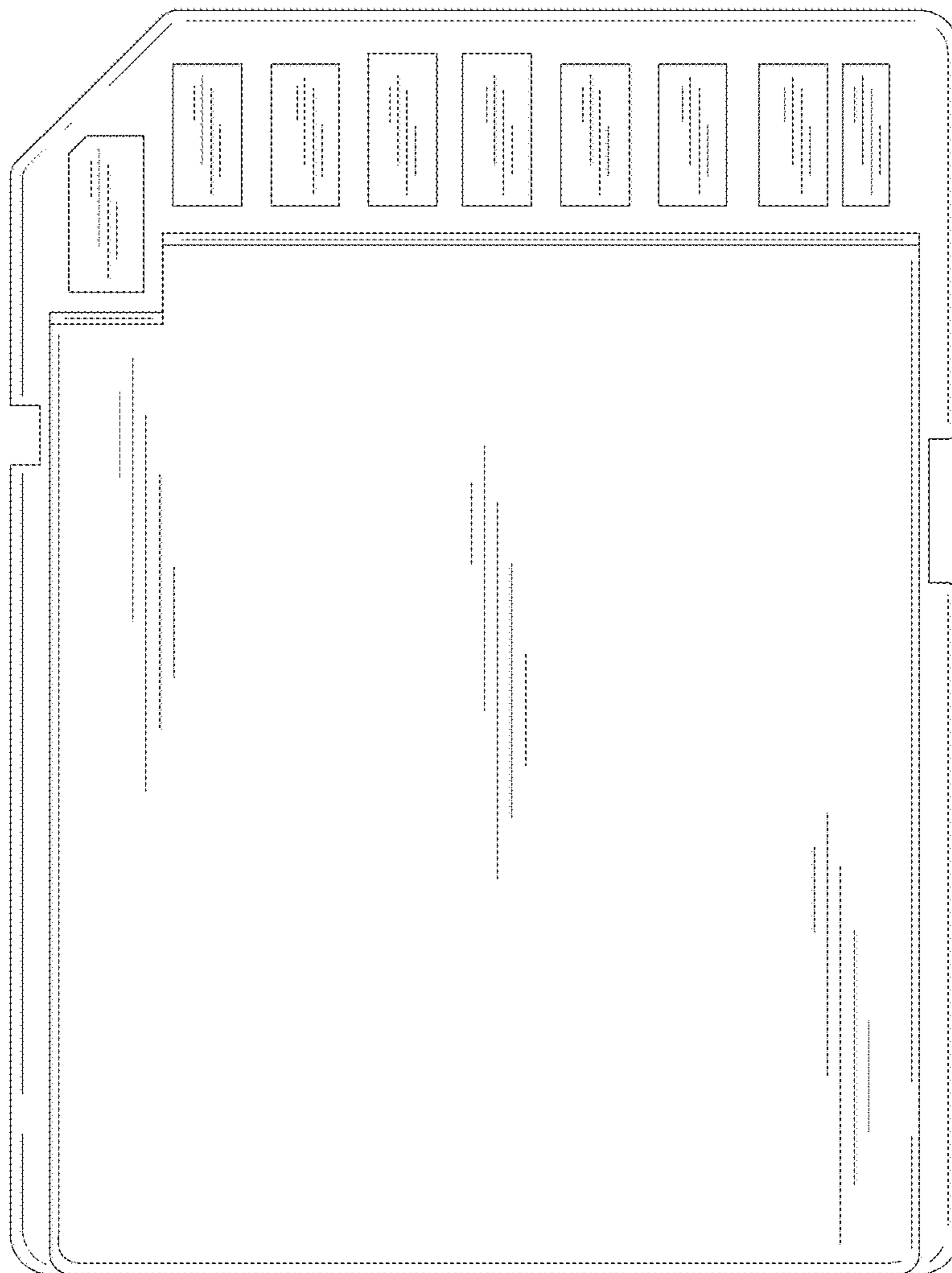

FIG.27

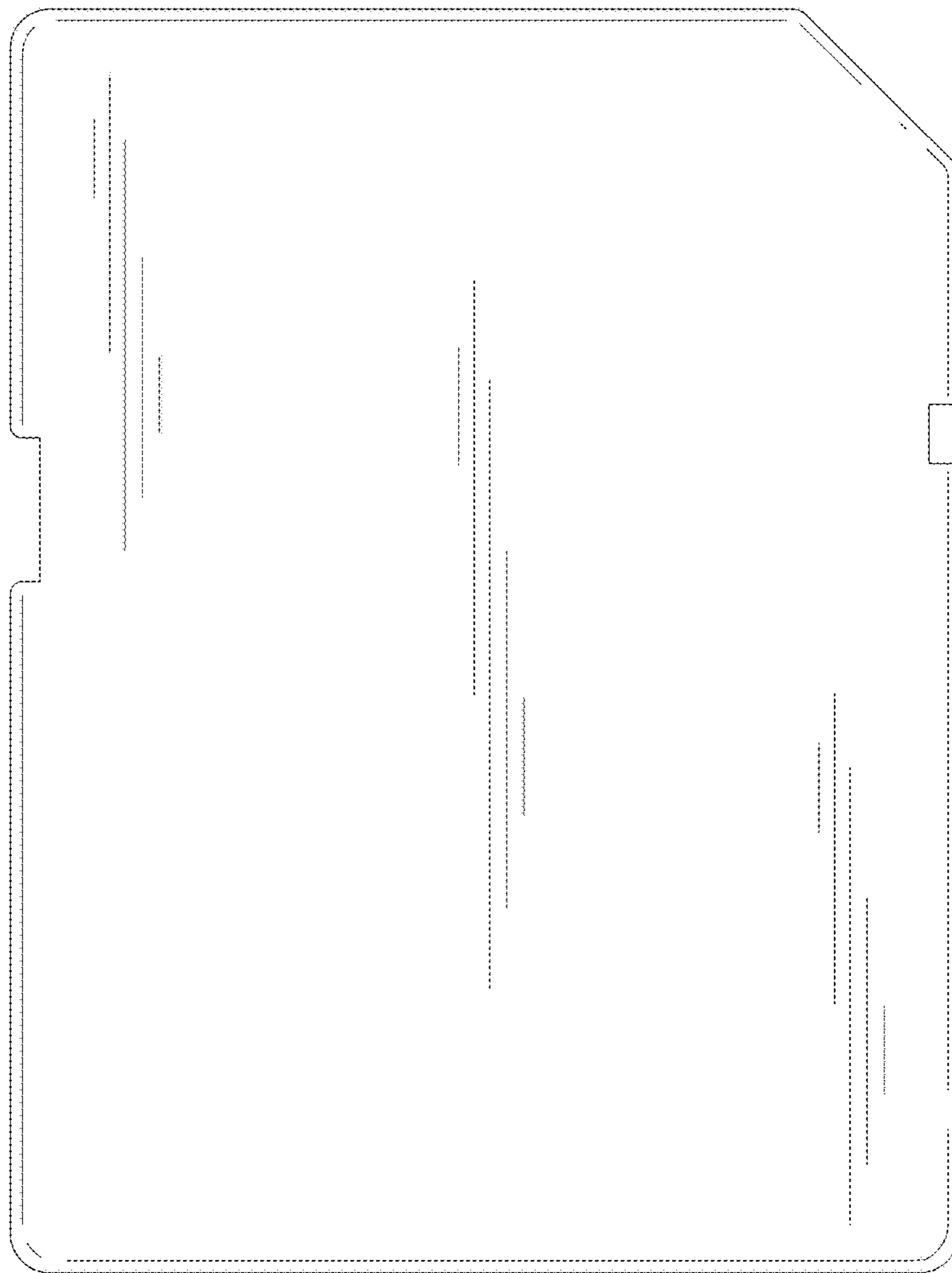

FIG.28

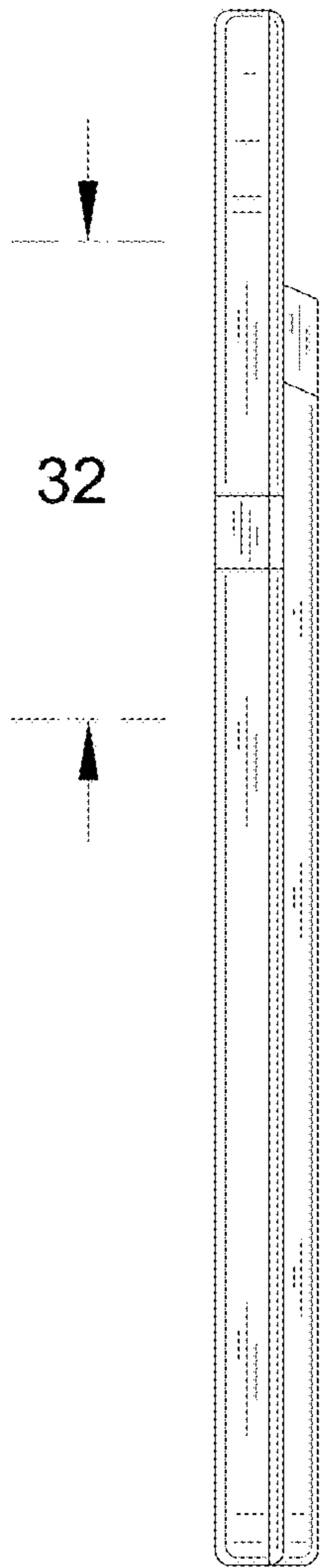

FIG.29

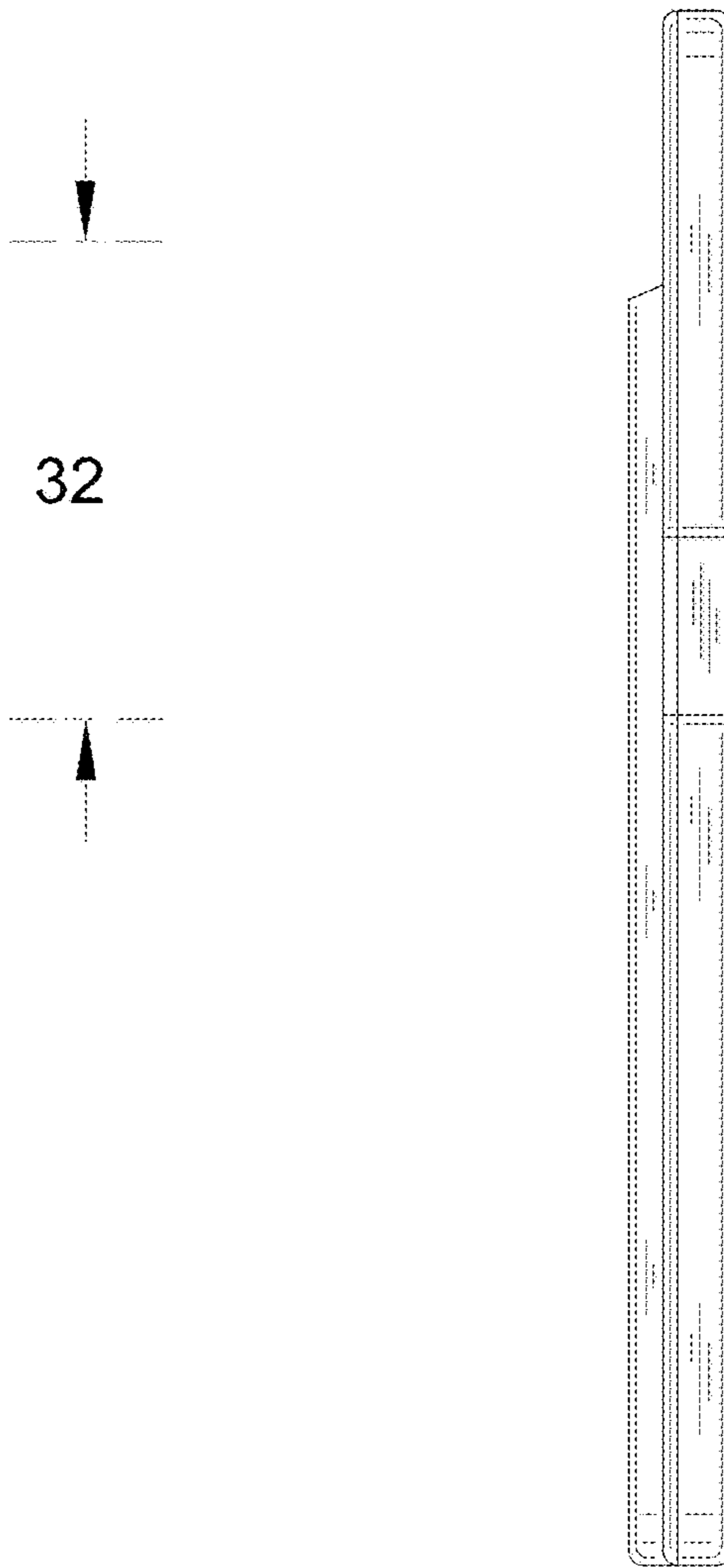

FIG.30

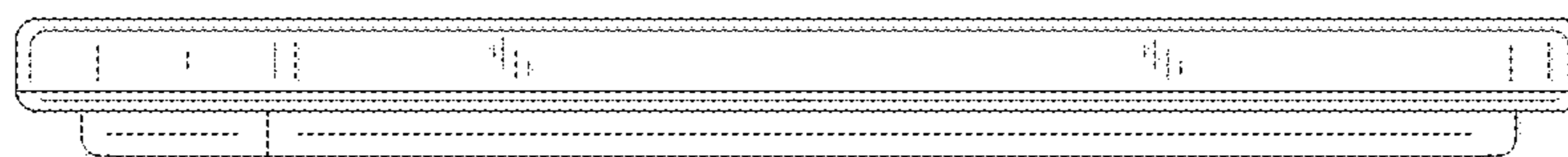

FIG.31

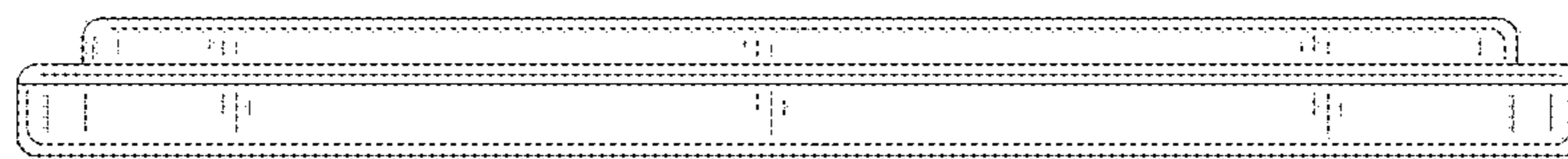

FIG.33

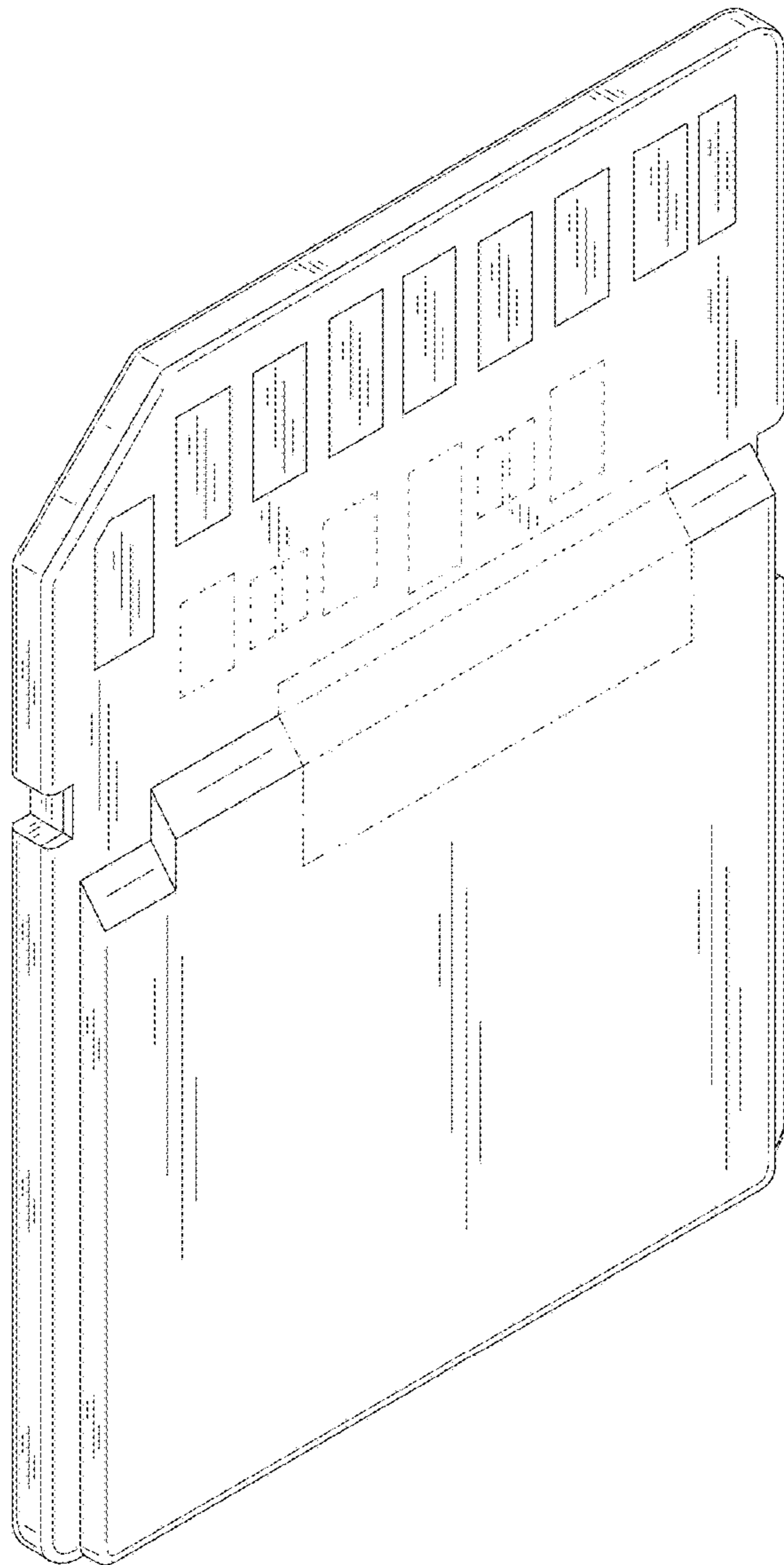

FIG.40

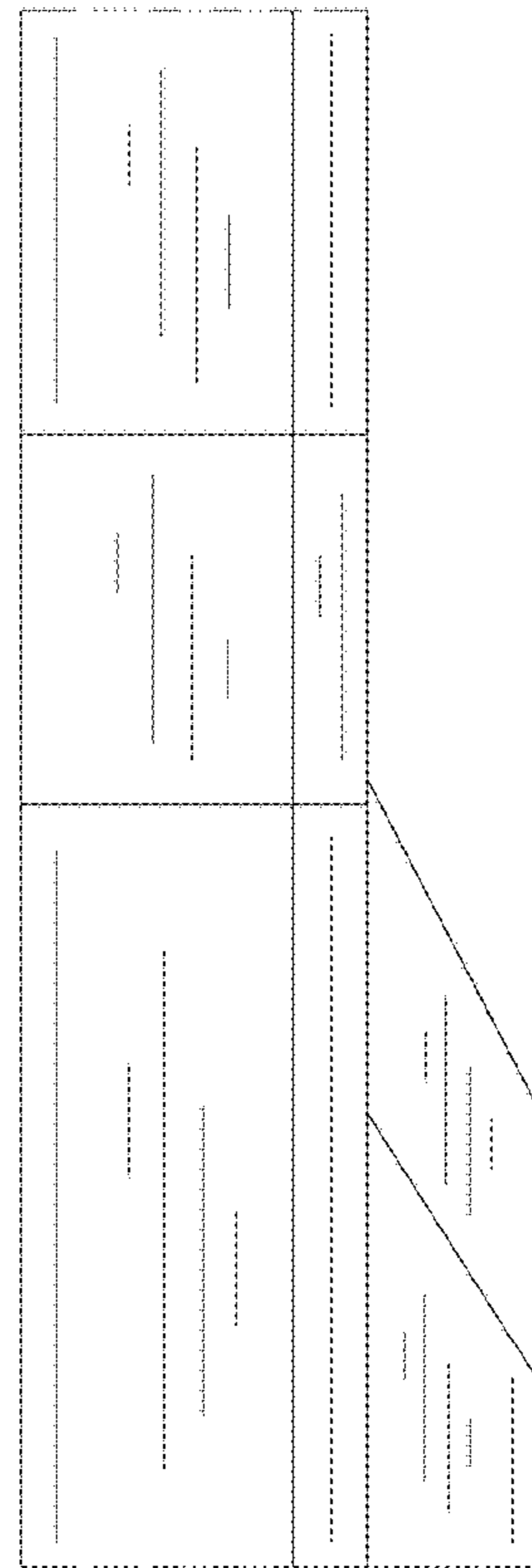

FIG.34

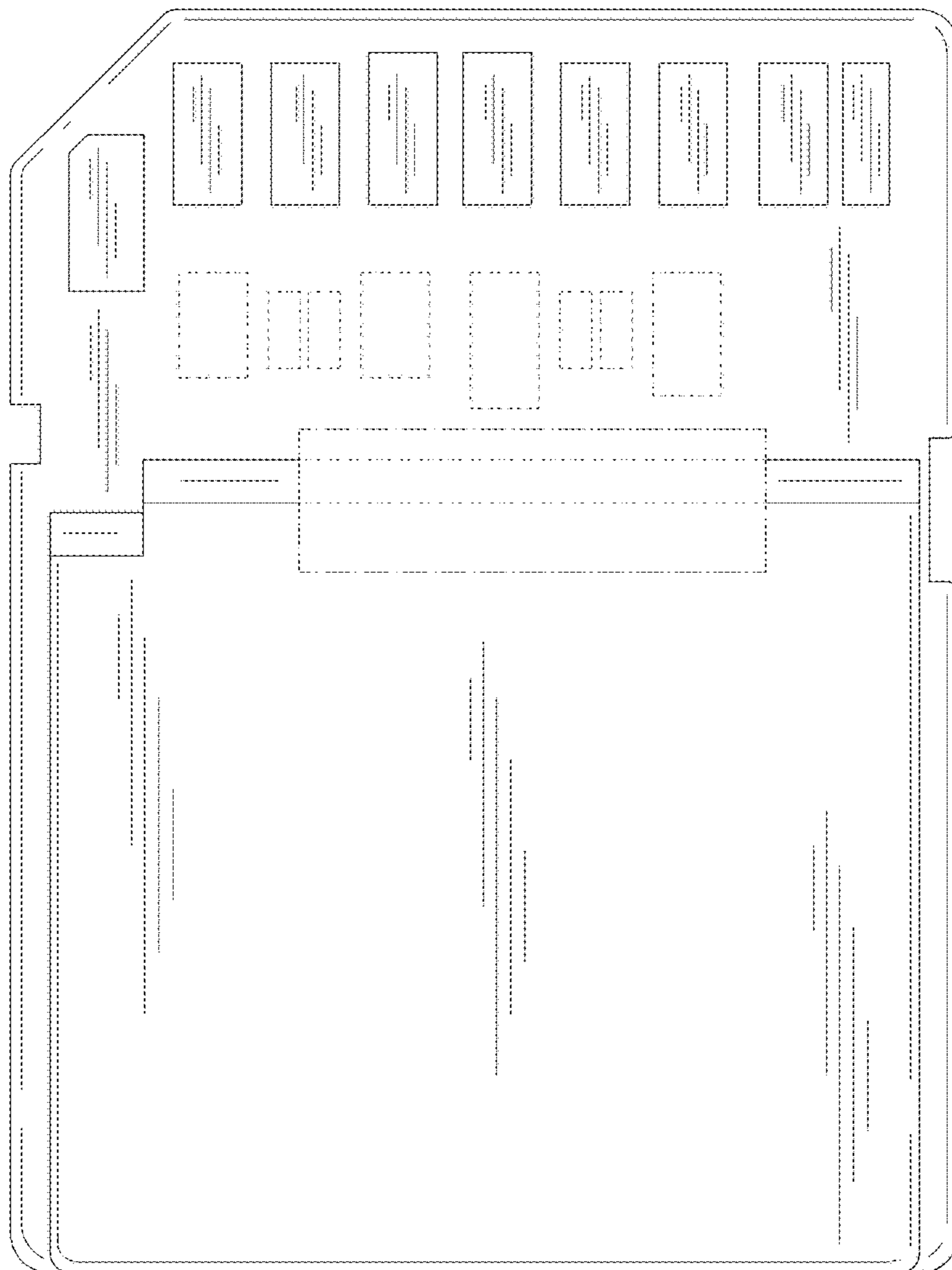

FIG.35

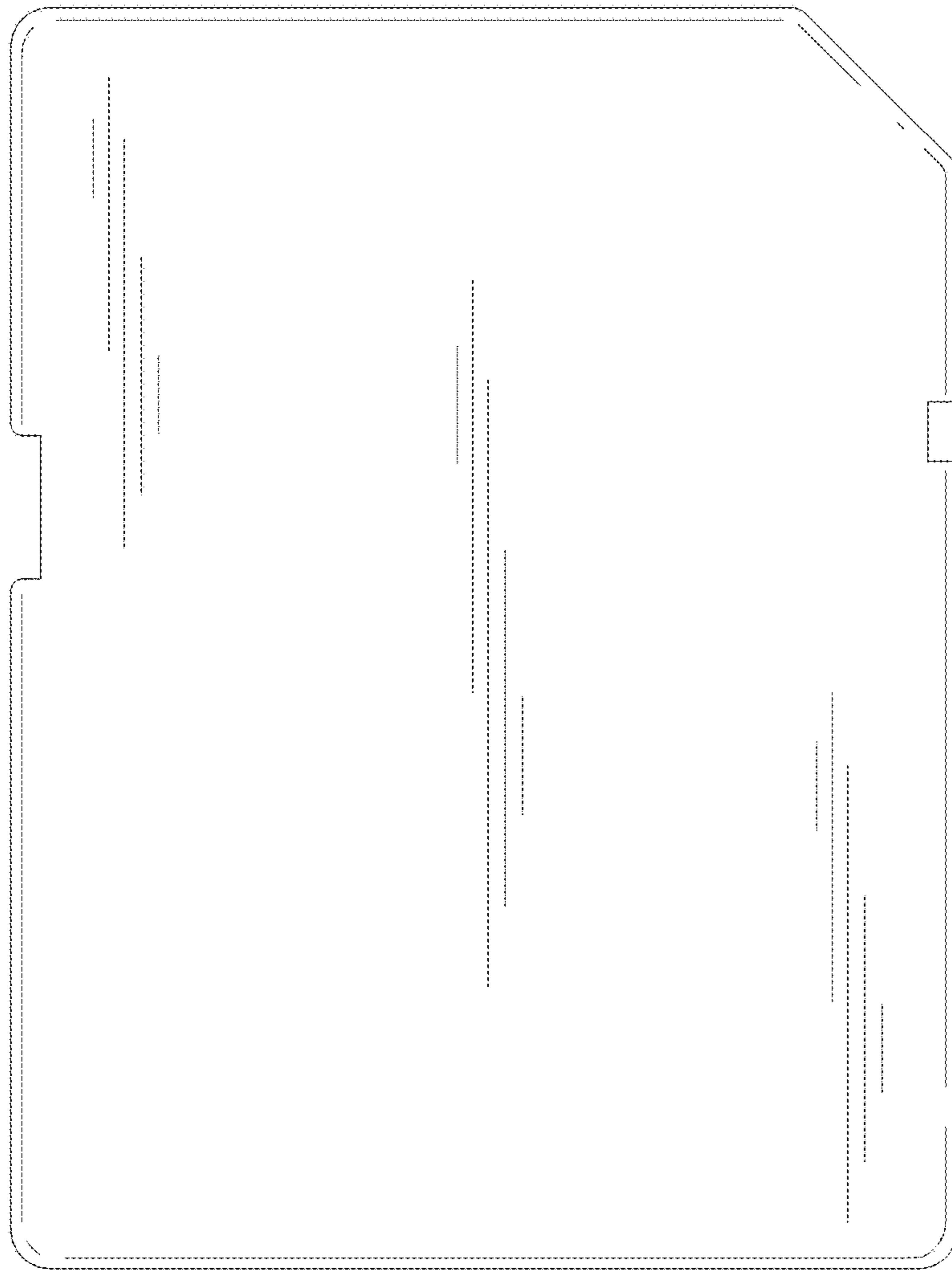

FIG.36

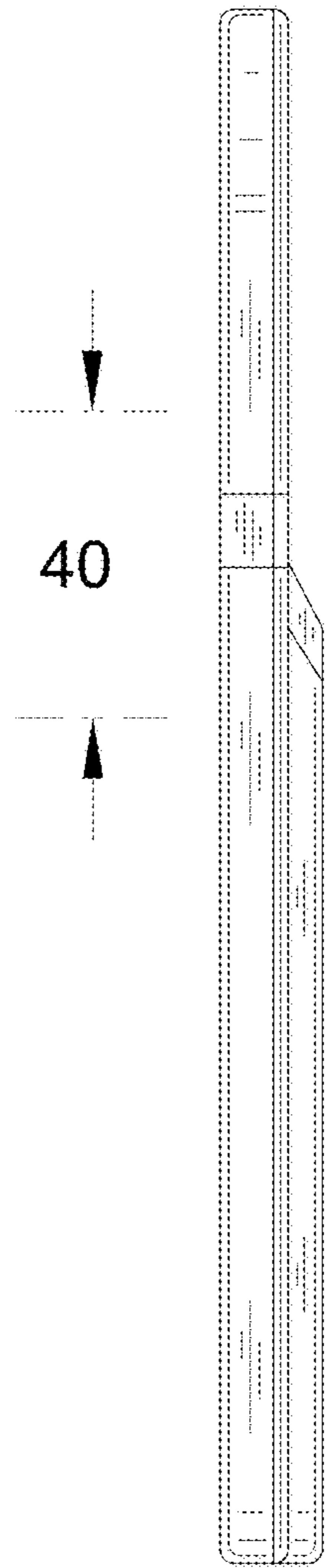

FIG.37

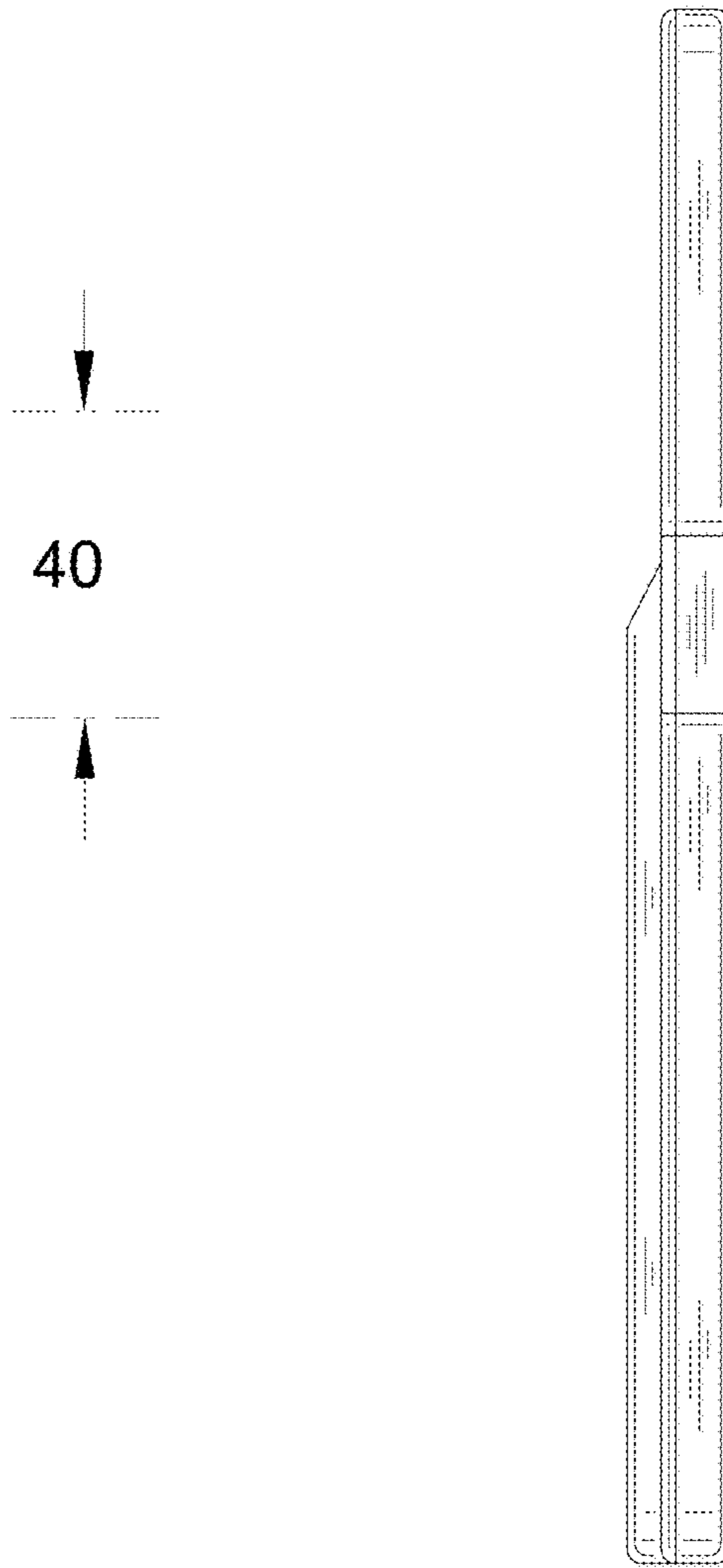

FIG.38

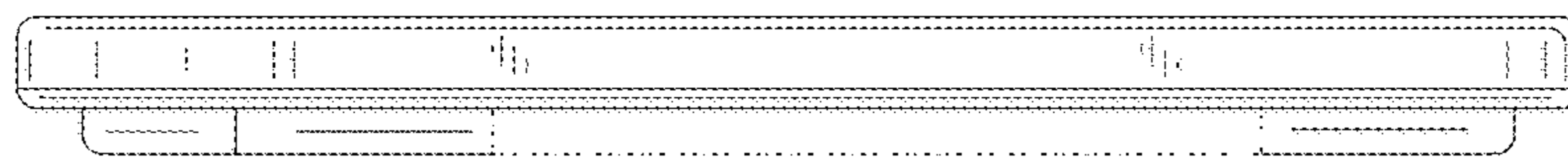

FIG.39

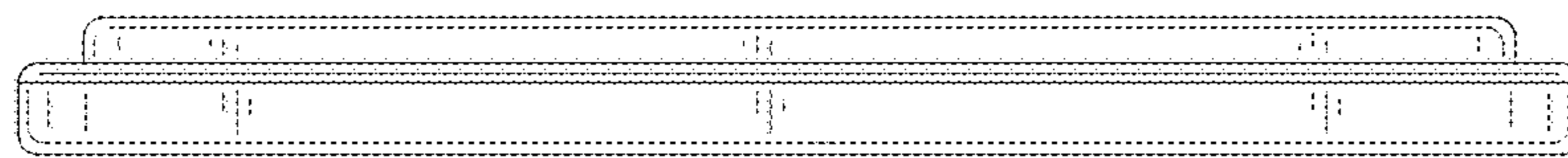

FIG.41

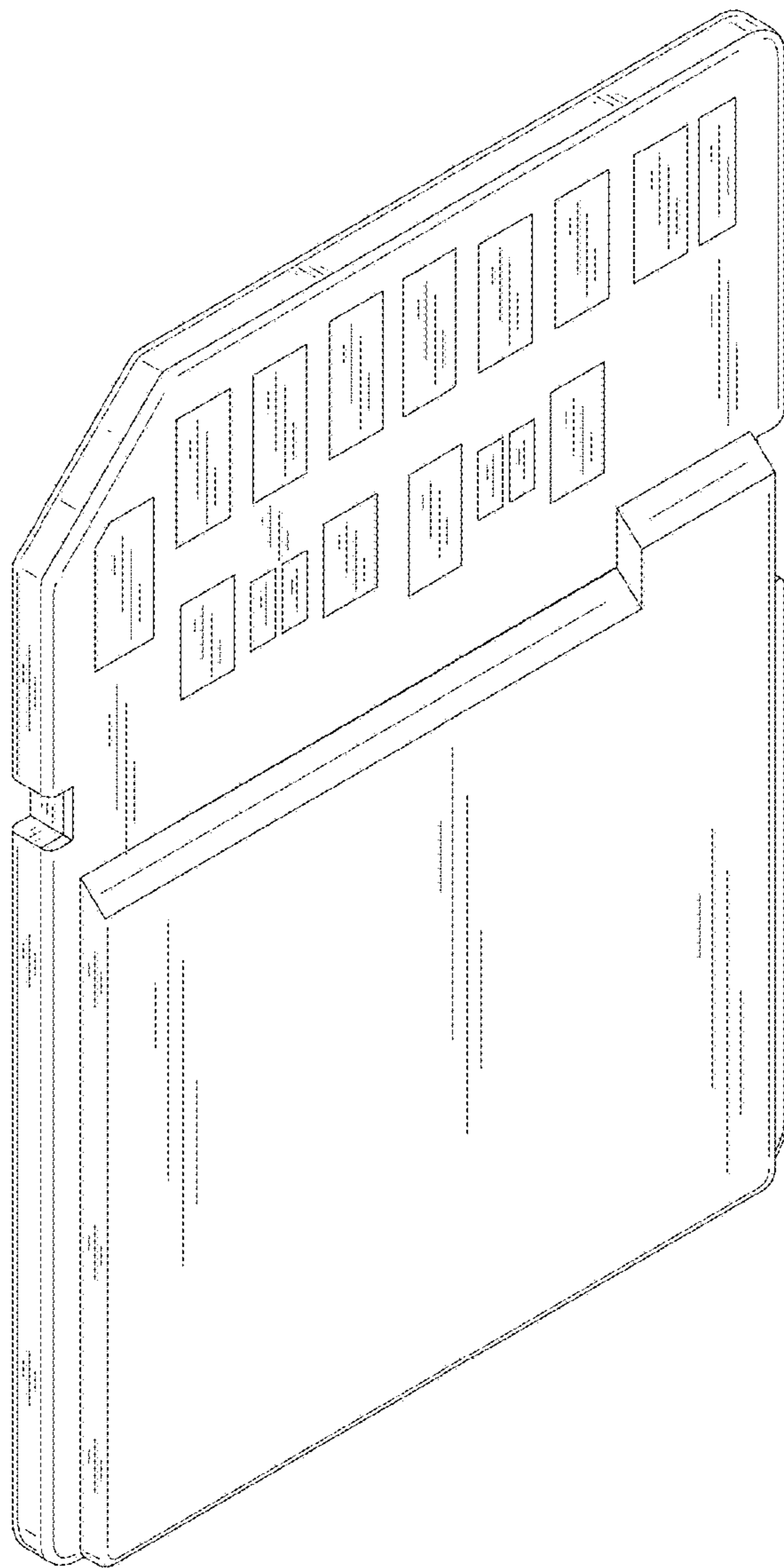

FIG.48

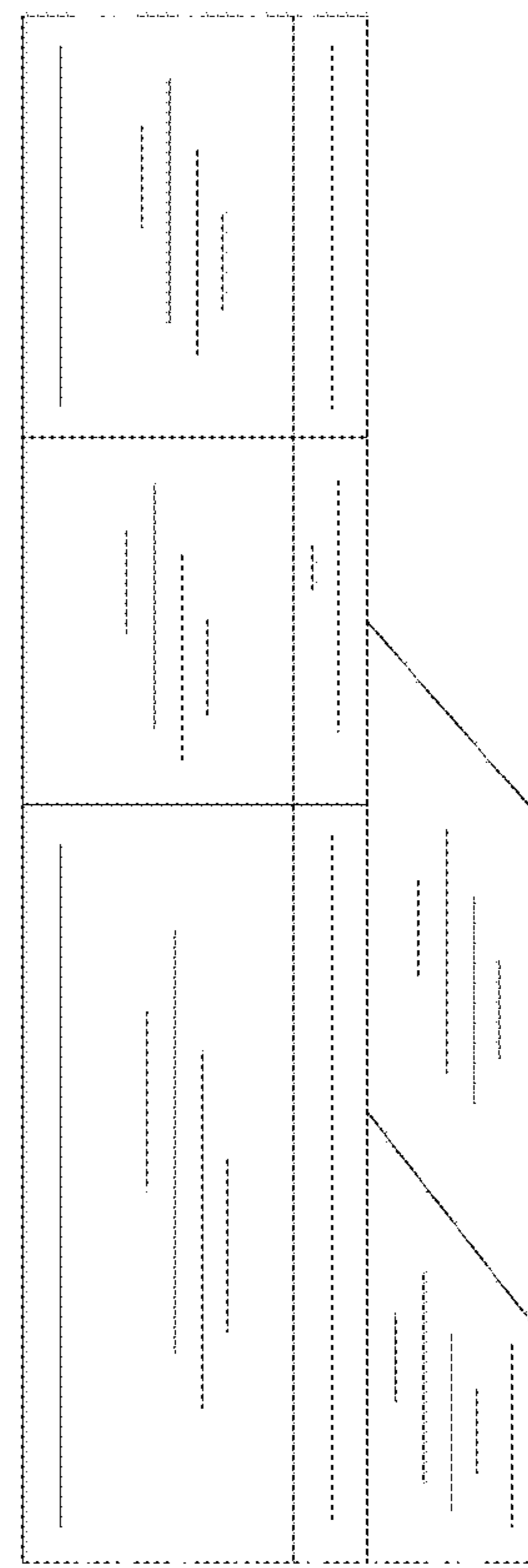

FIG.42

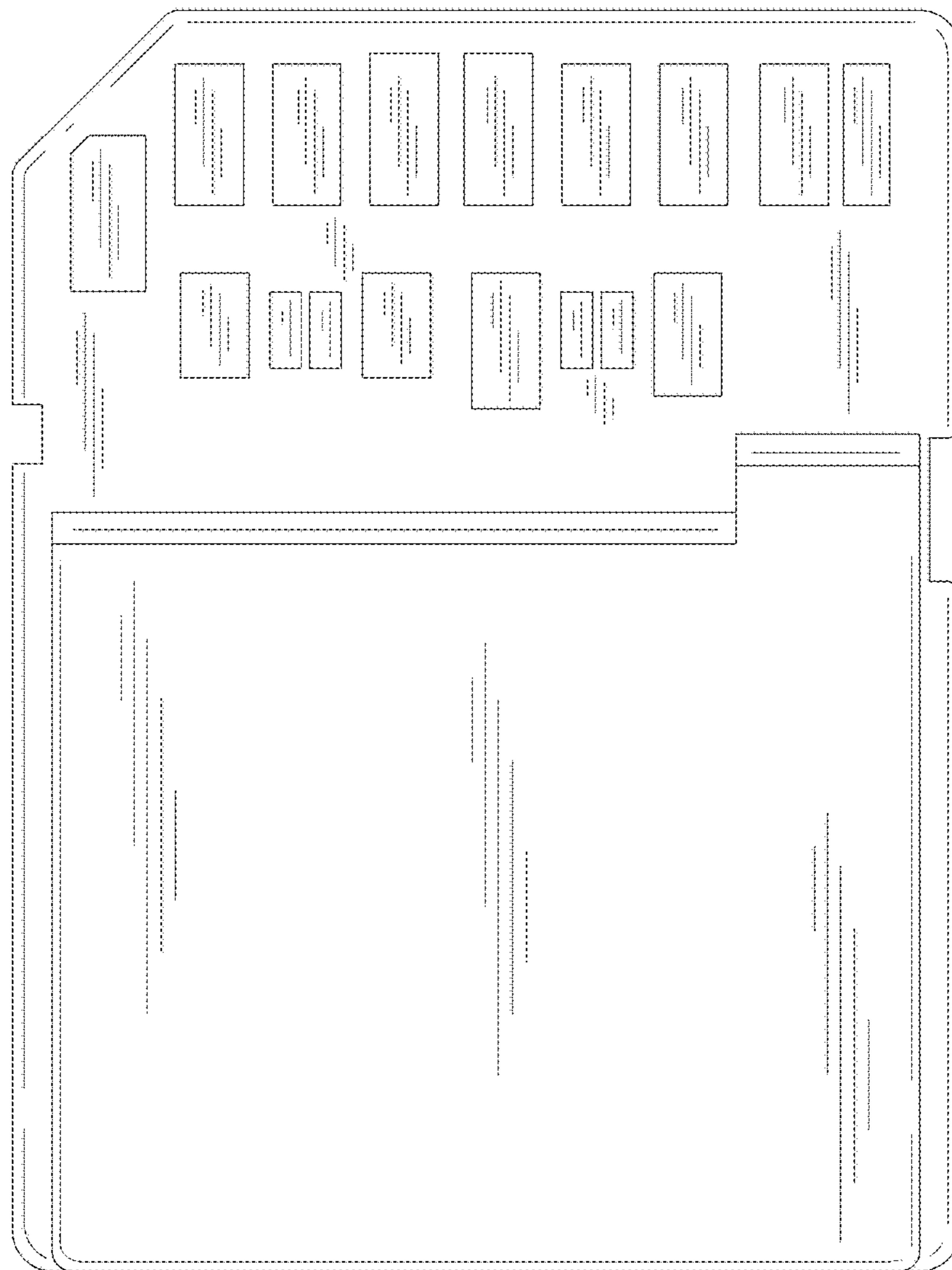

FIG.43

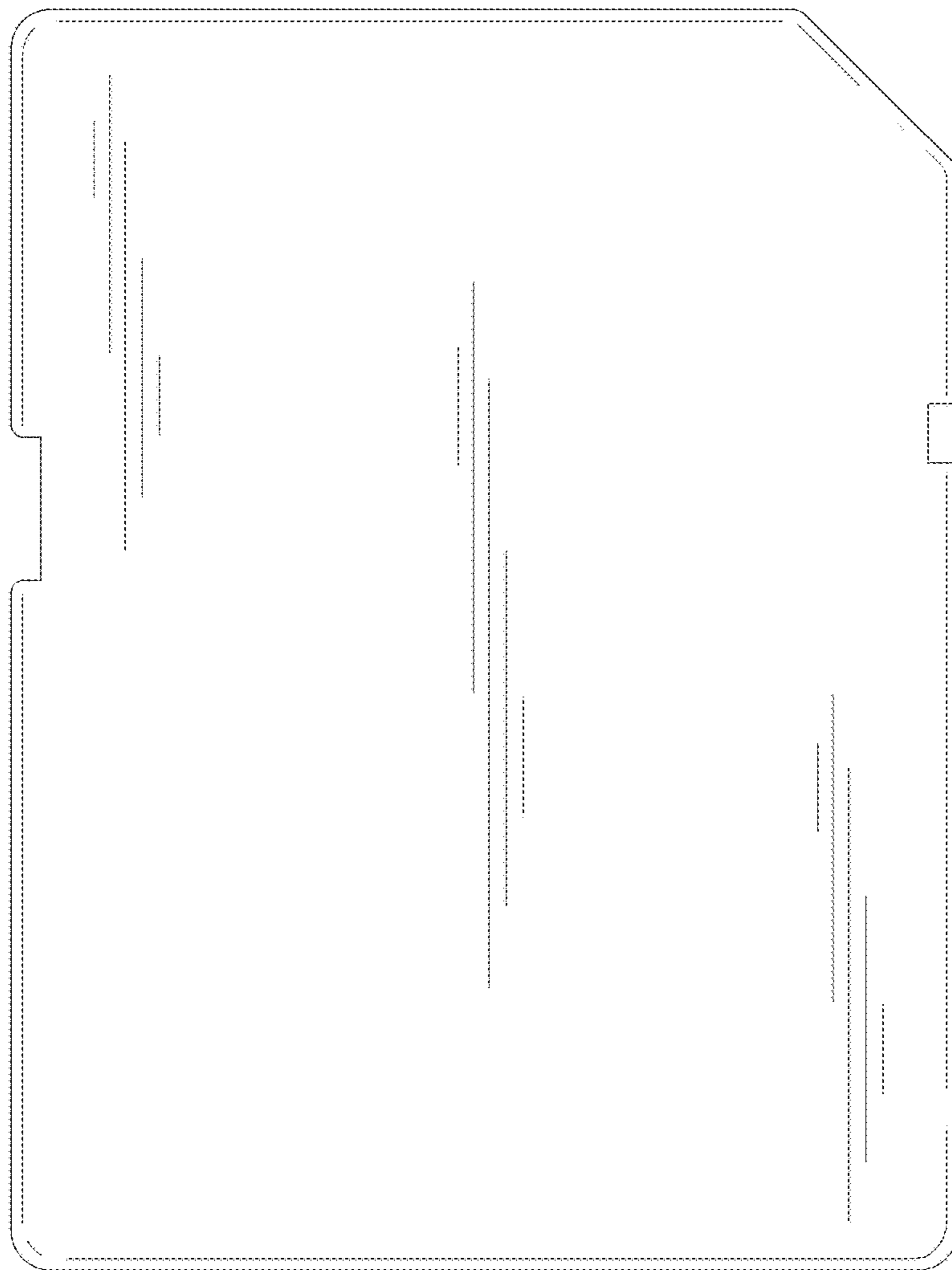

FIG.44

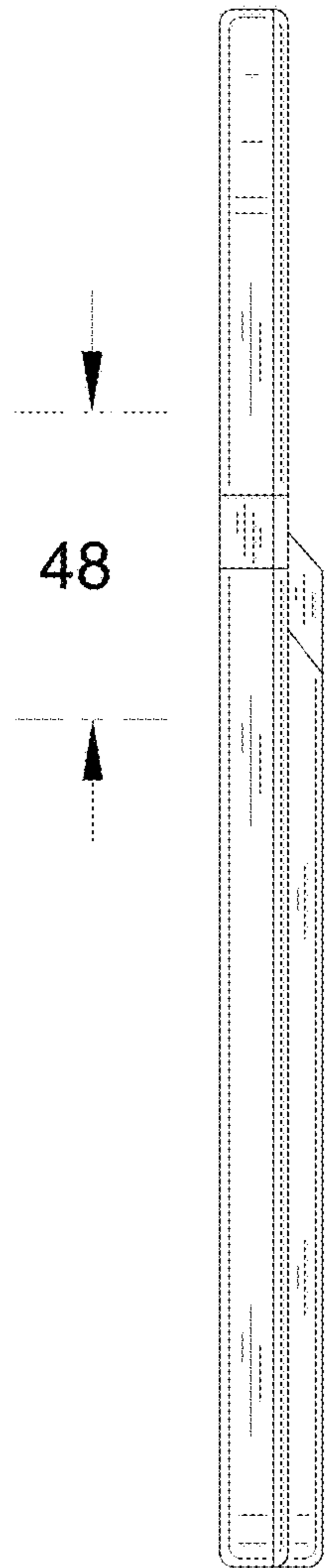

FIG.45

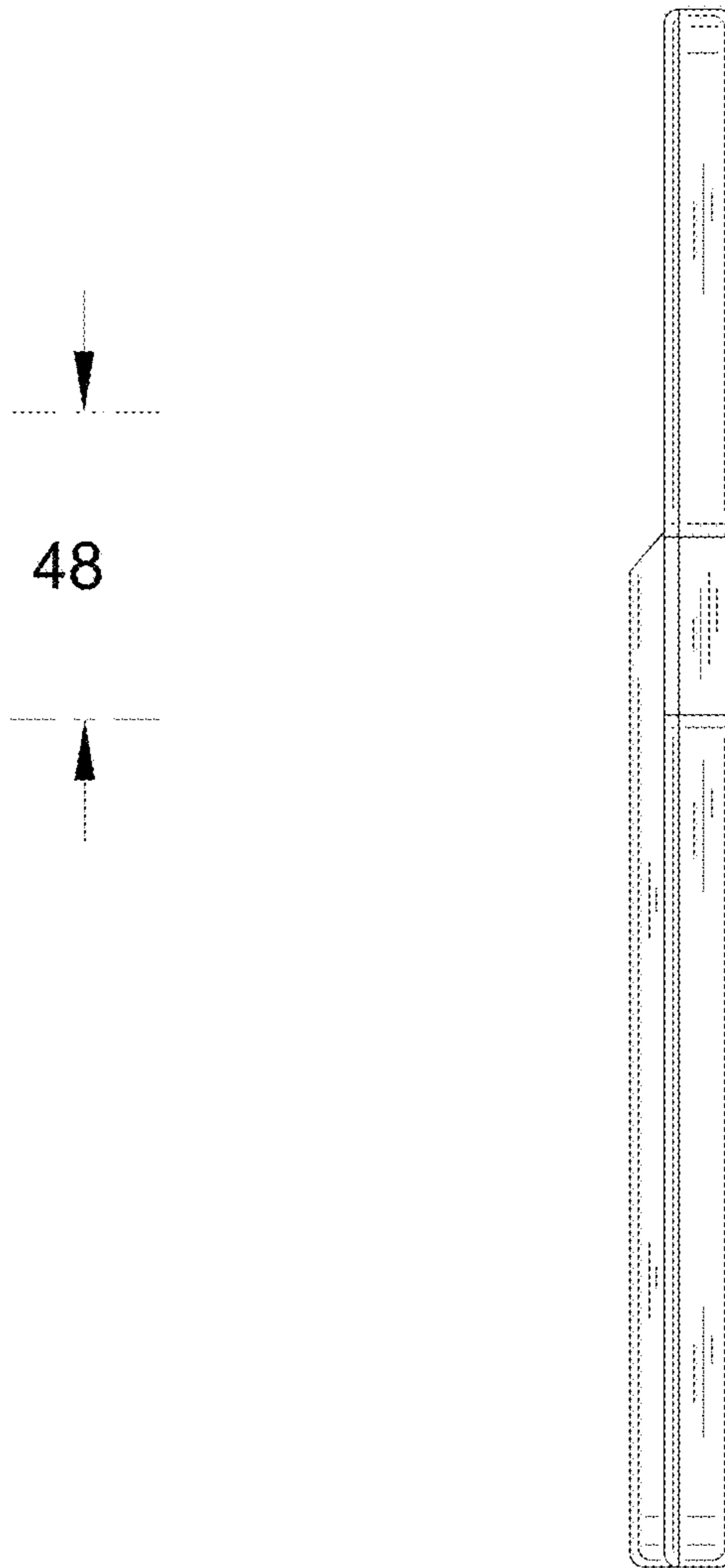

FIG.46

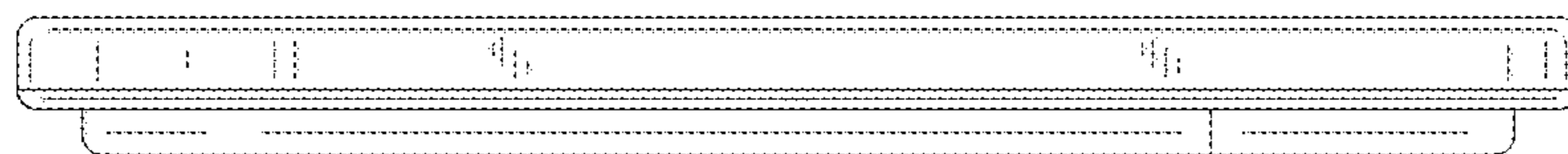

FIG.47

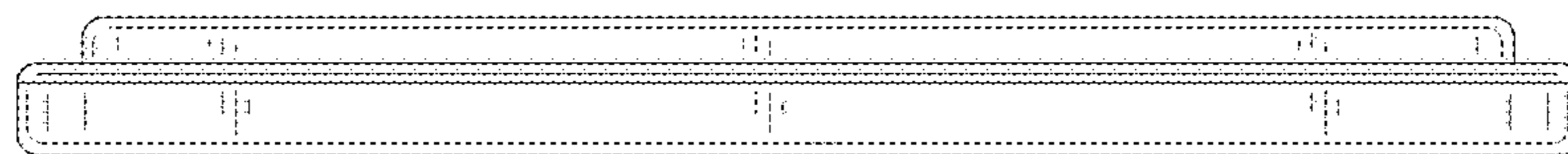

FIG.49

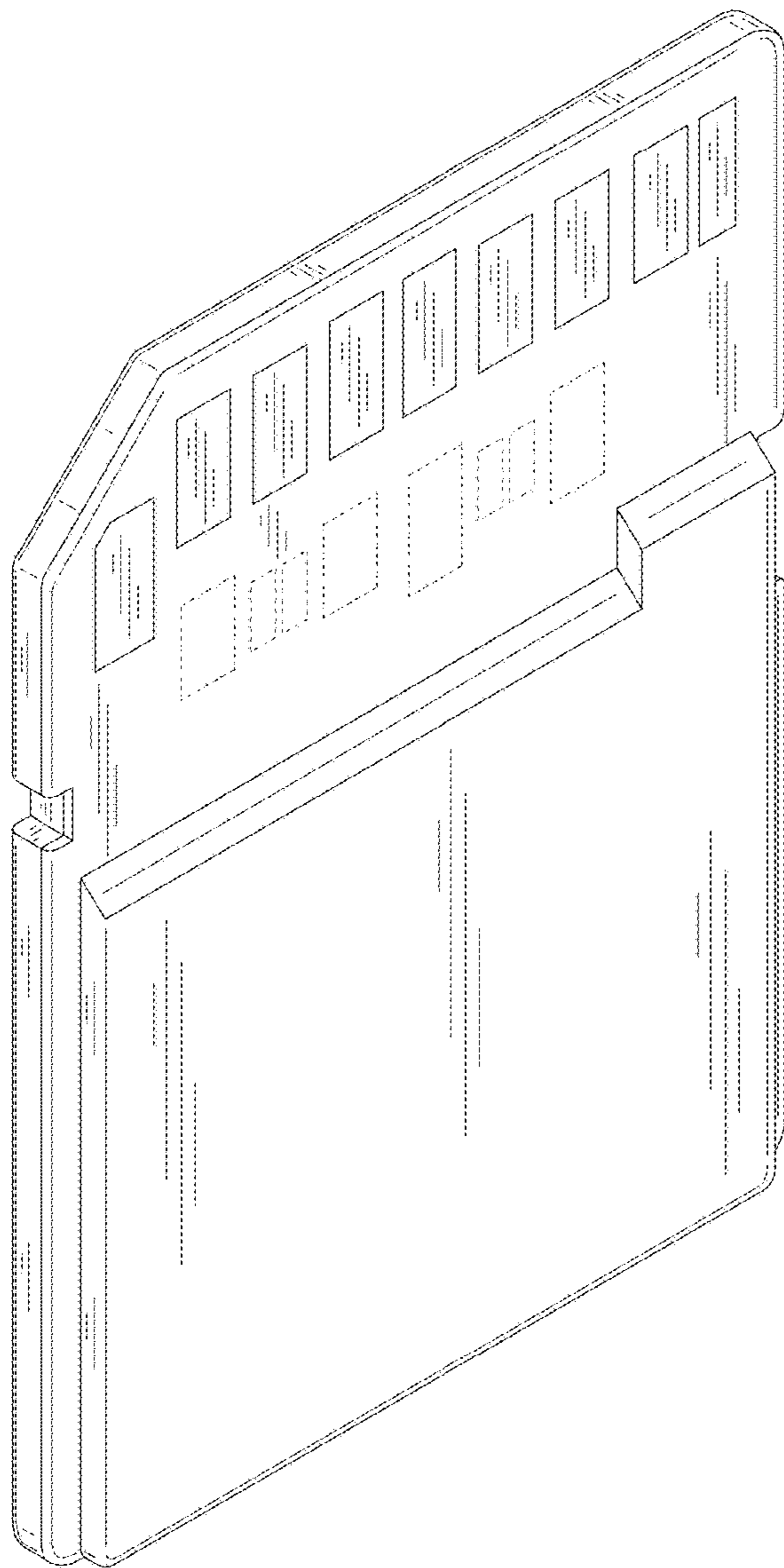

FIG.56

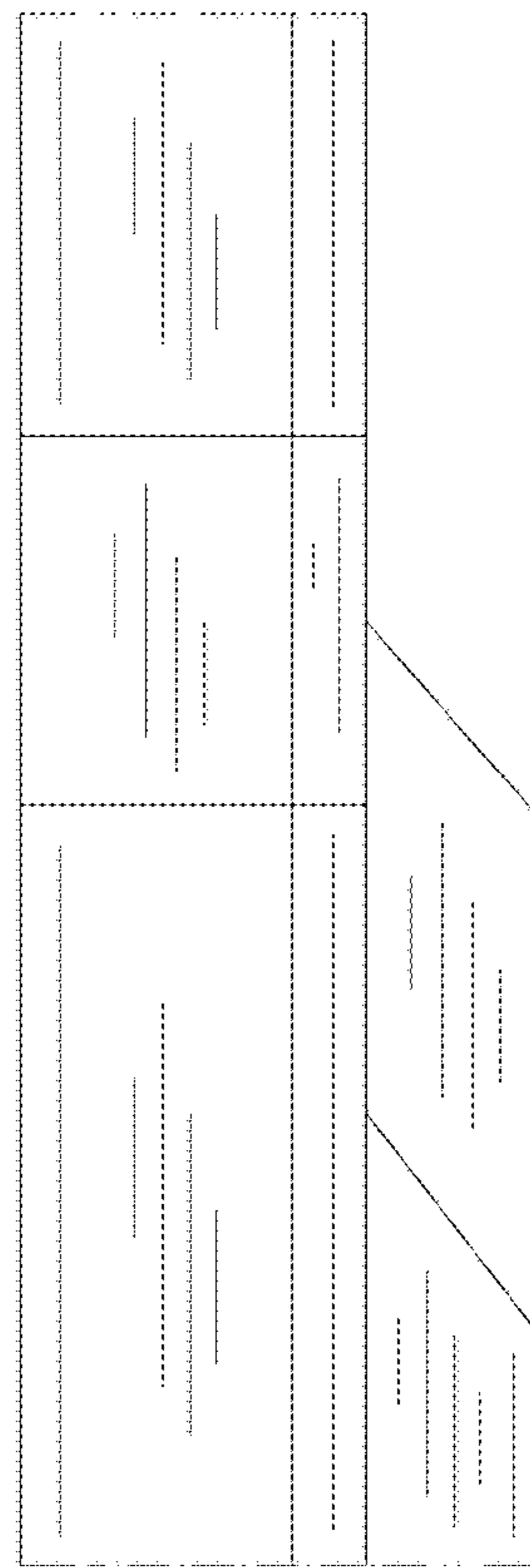

FIG.50

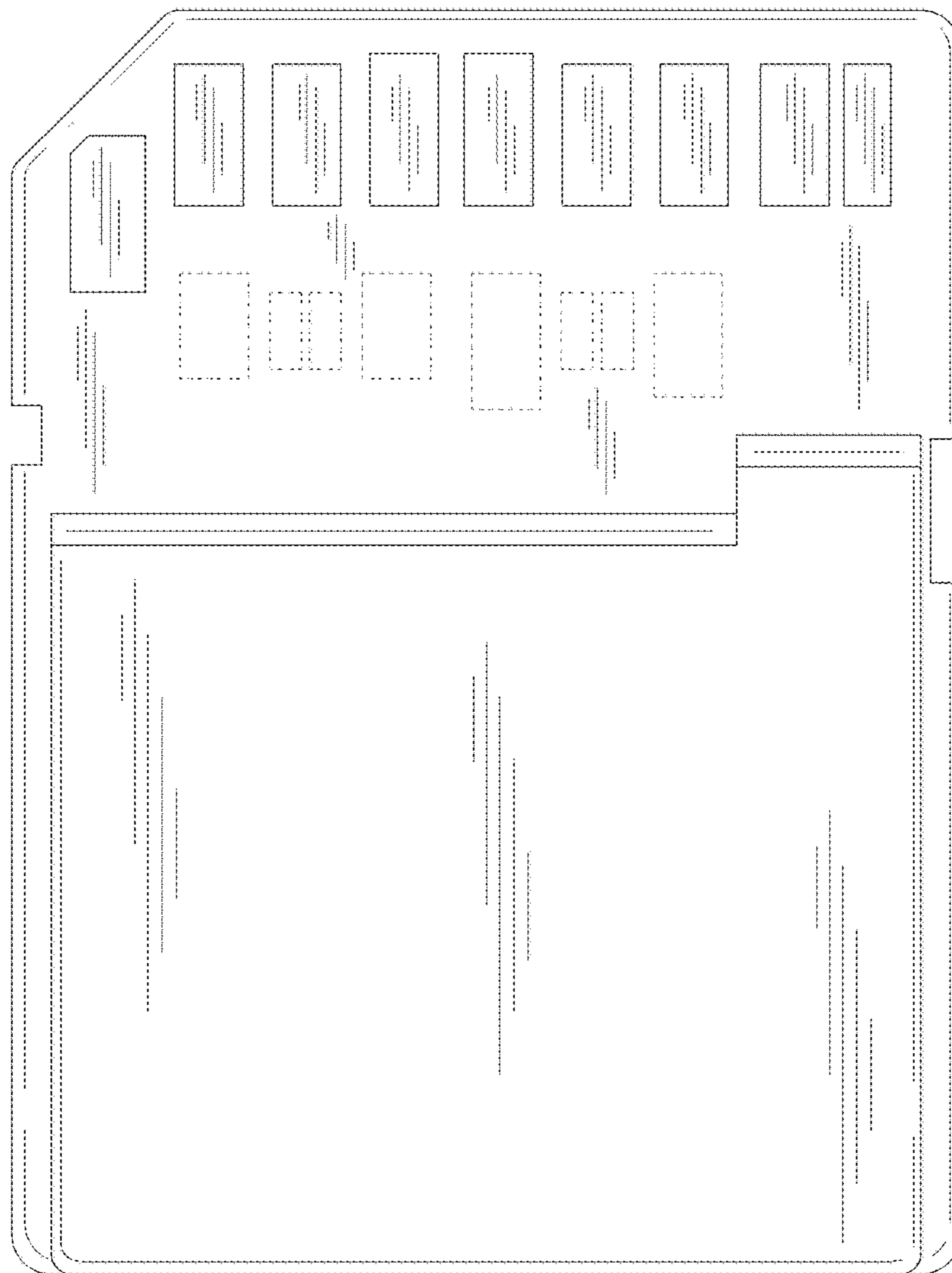

FIG.51

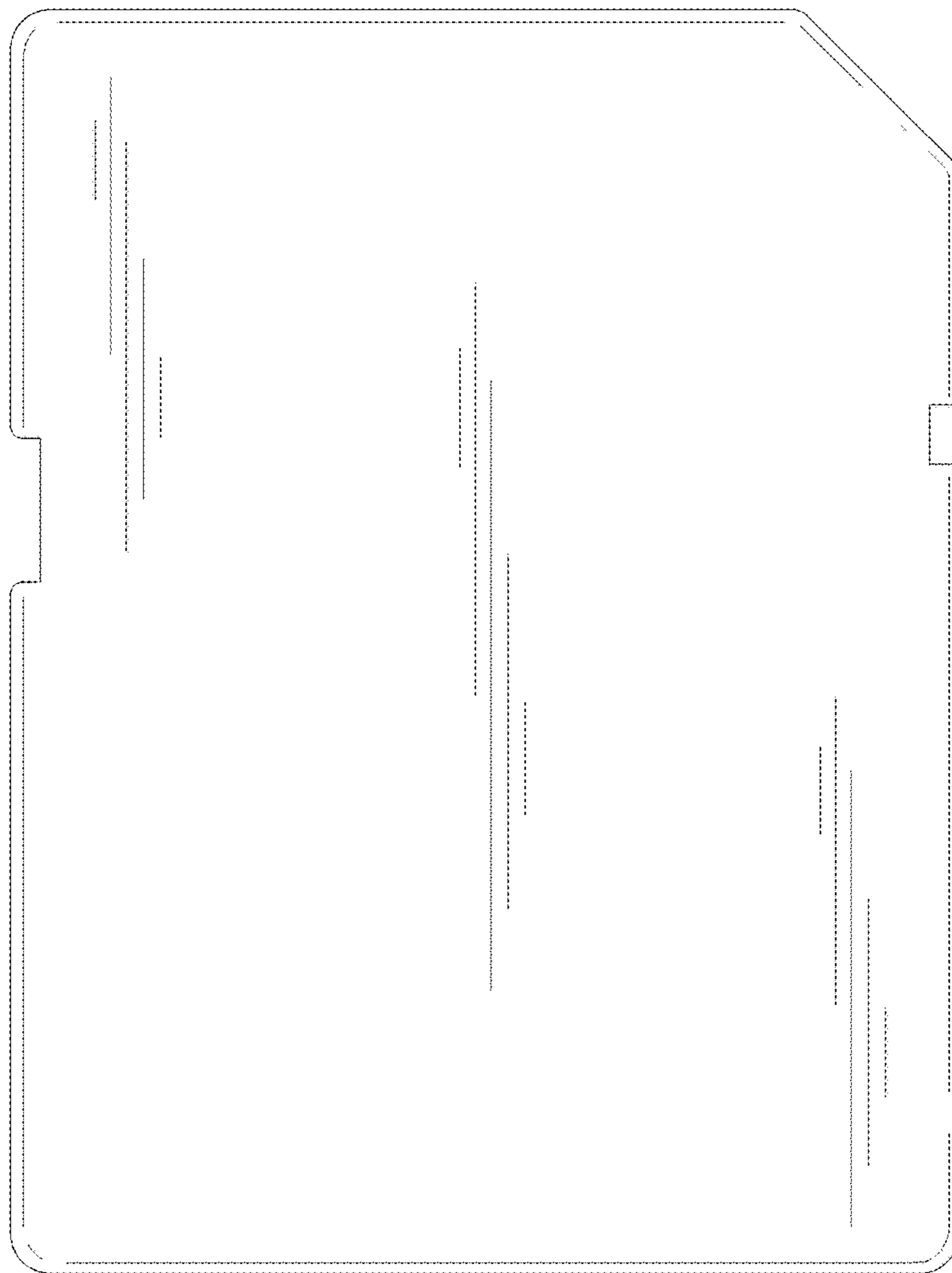

FIG.52

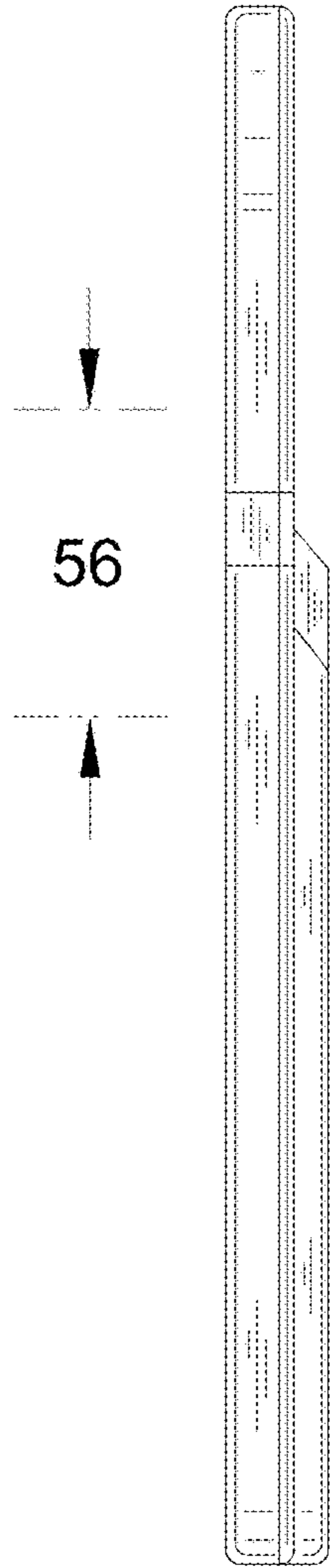

FIG.53

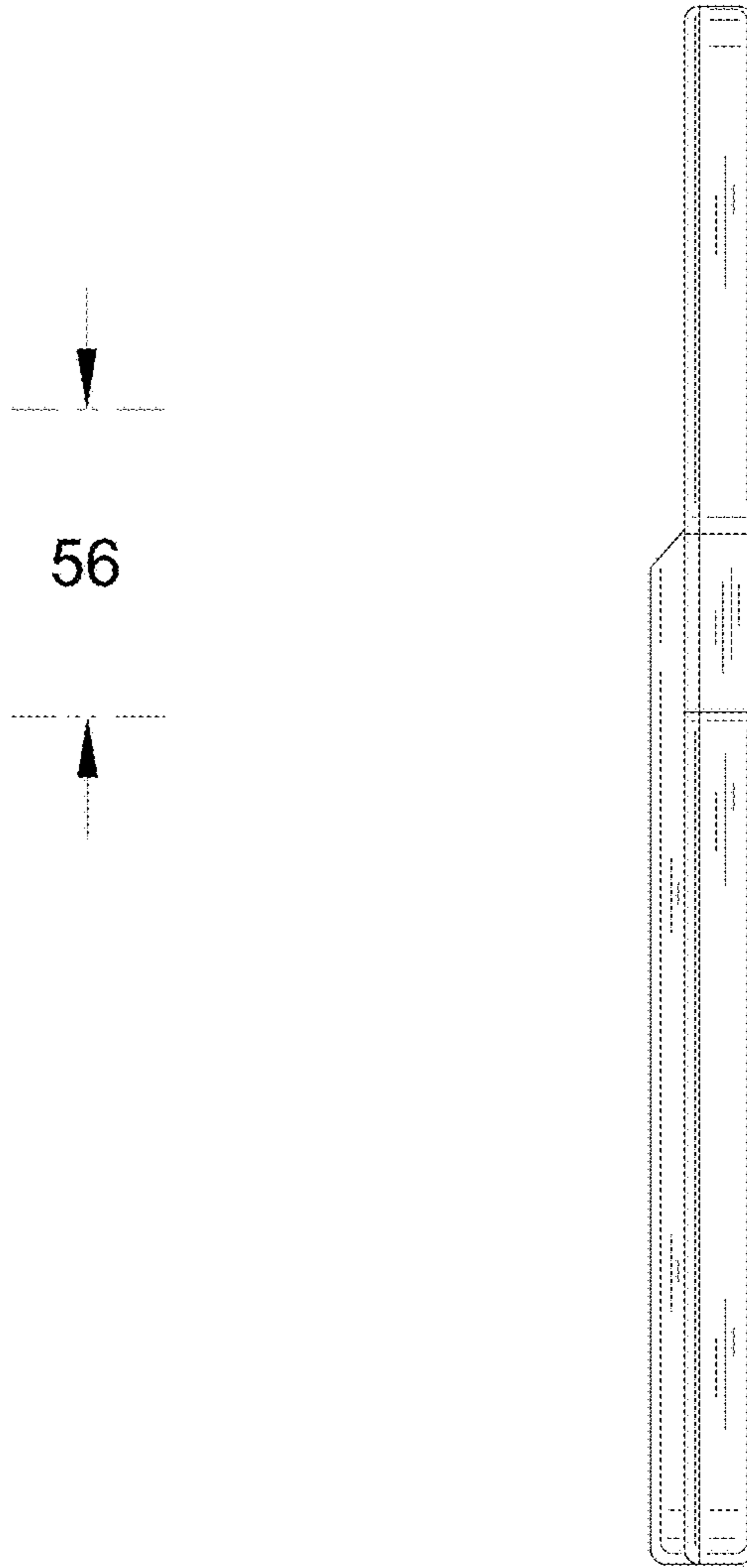

FIG.54

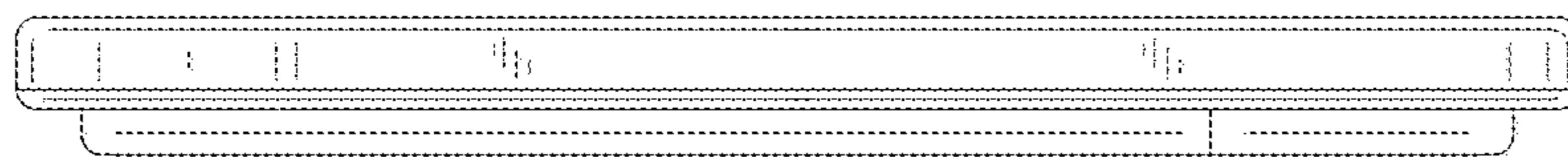

FIG.55

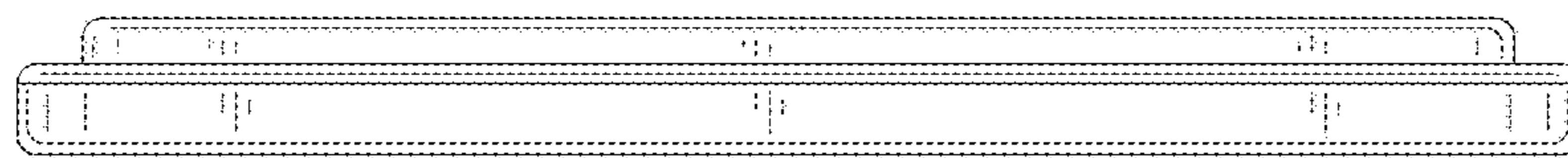

FIG.57

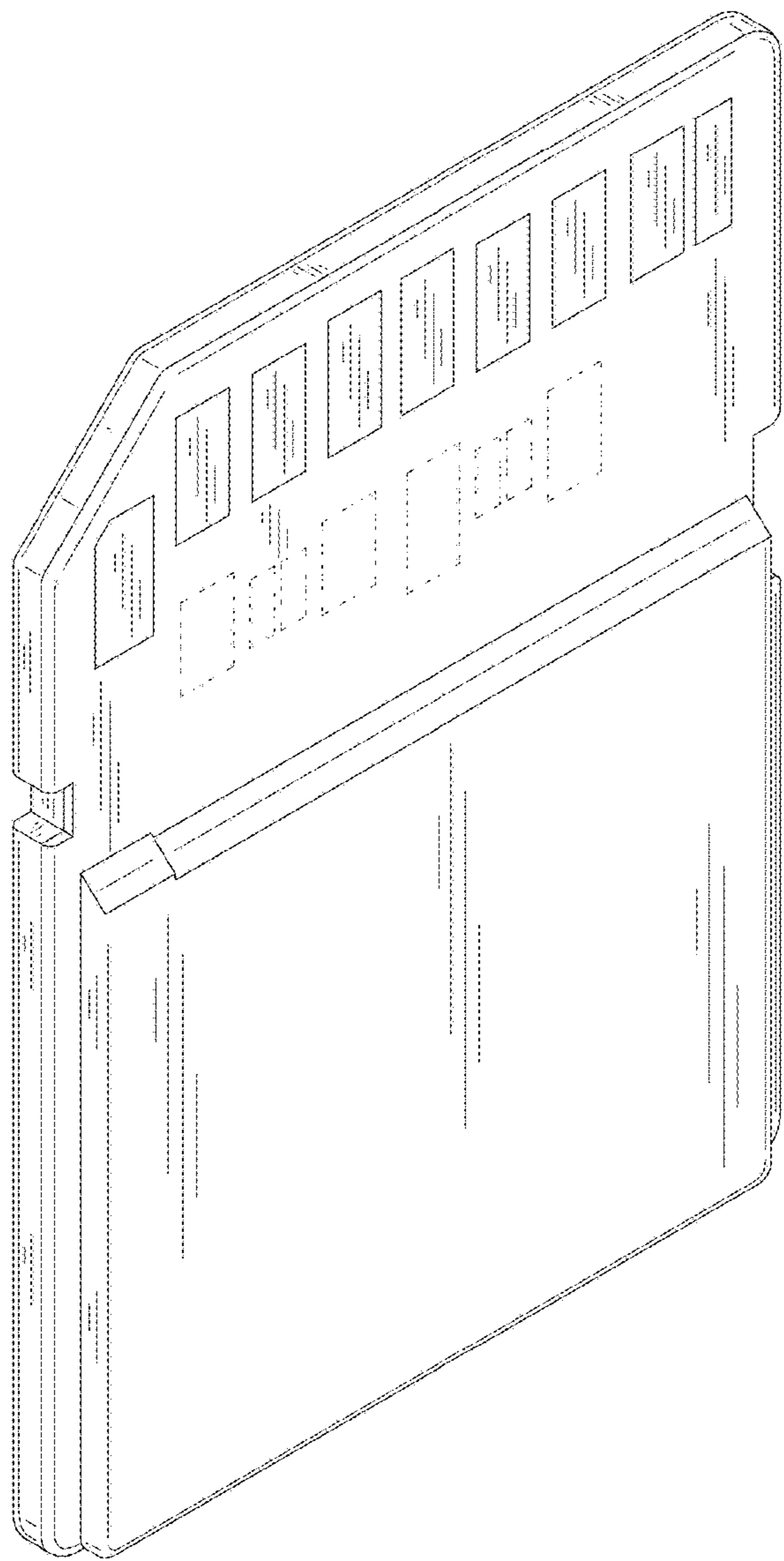

FIG.64

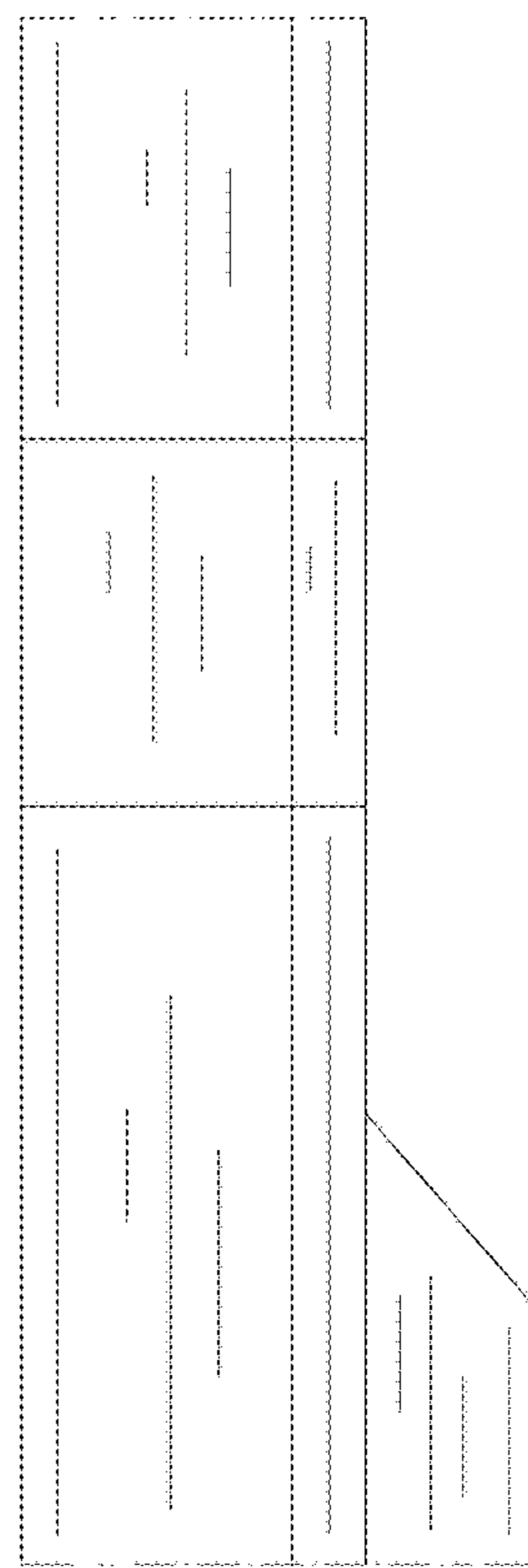

FIG.58

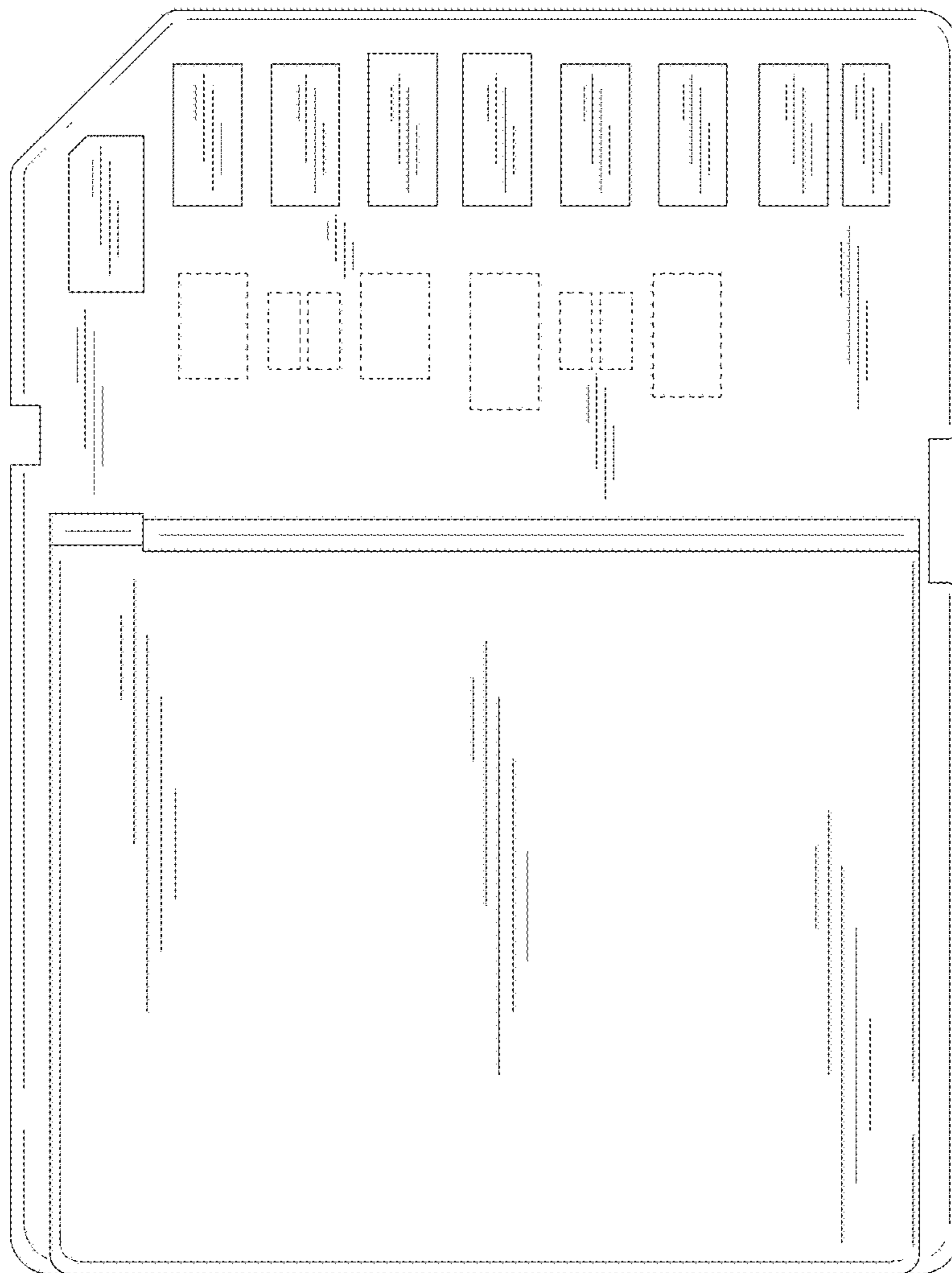

FIG.59

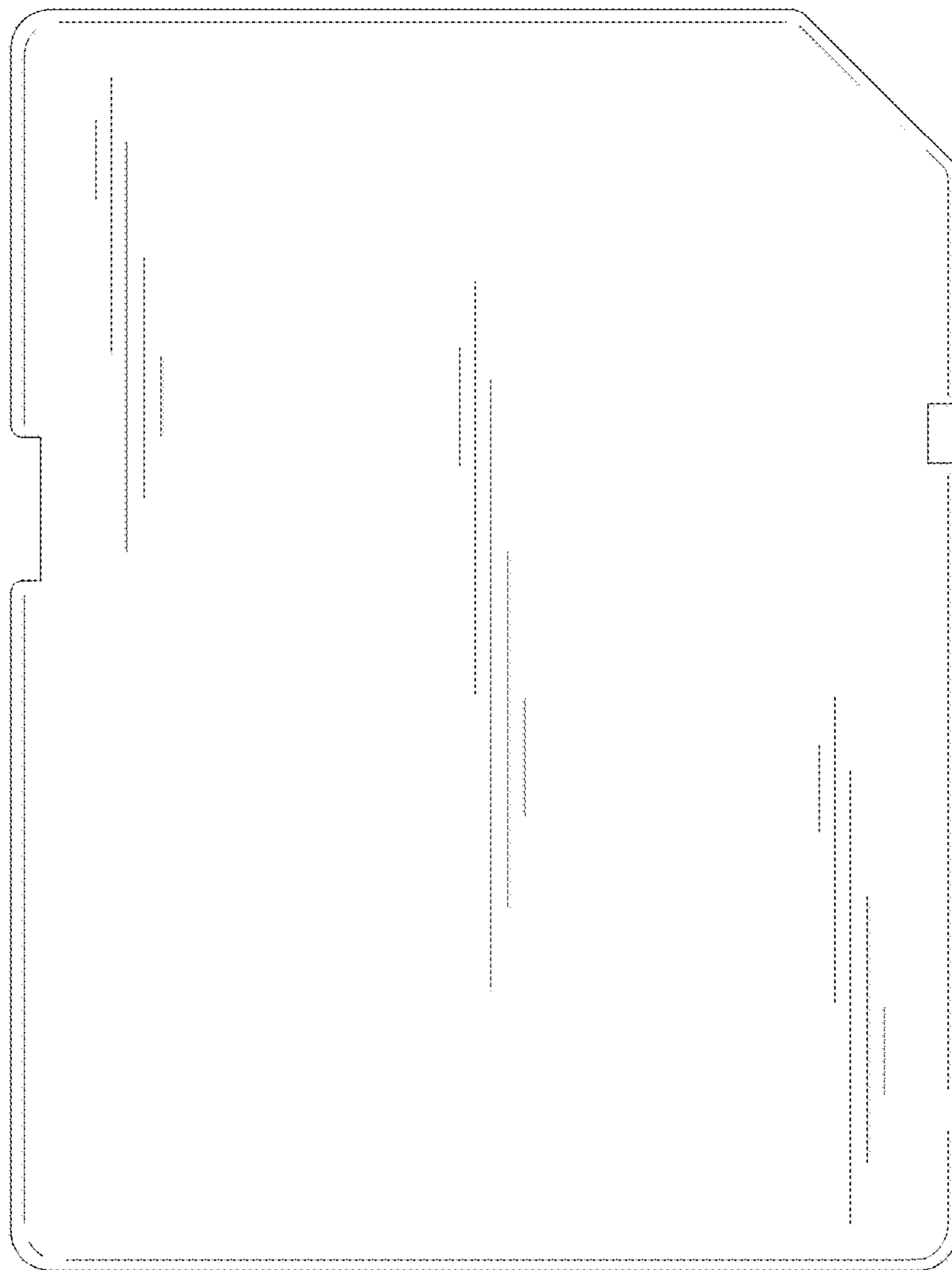

FIG.60

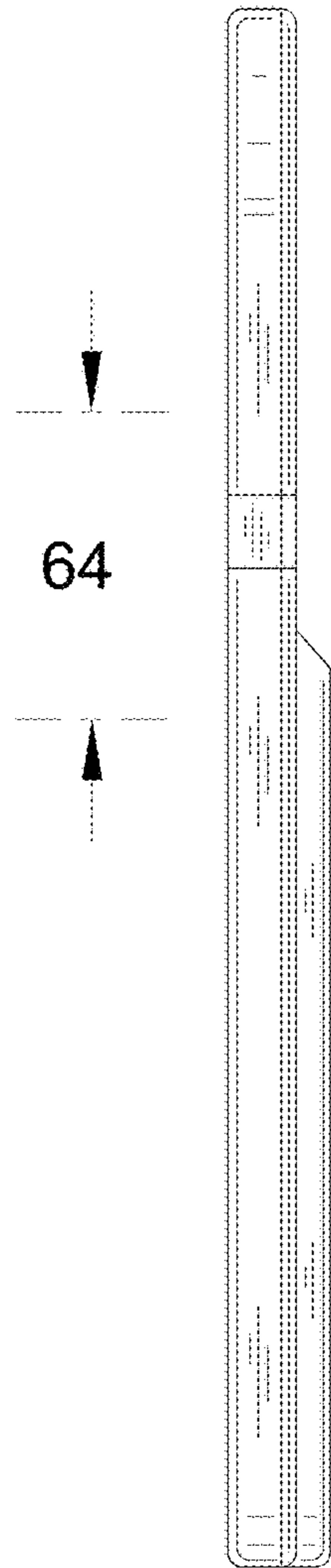

FIG.61

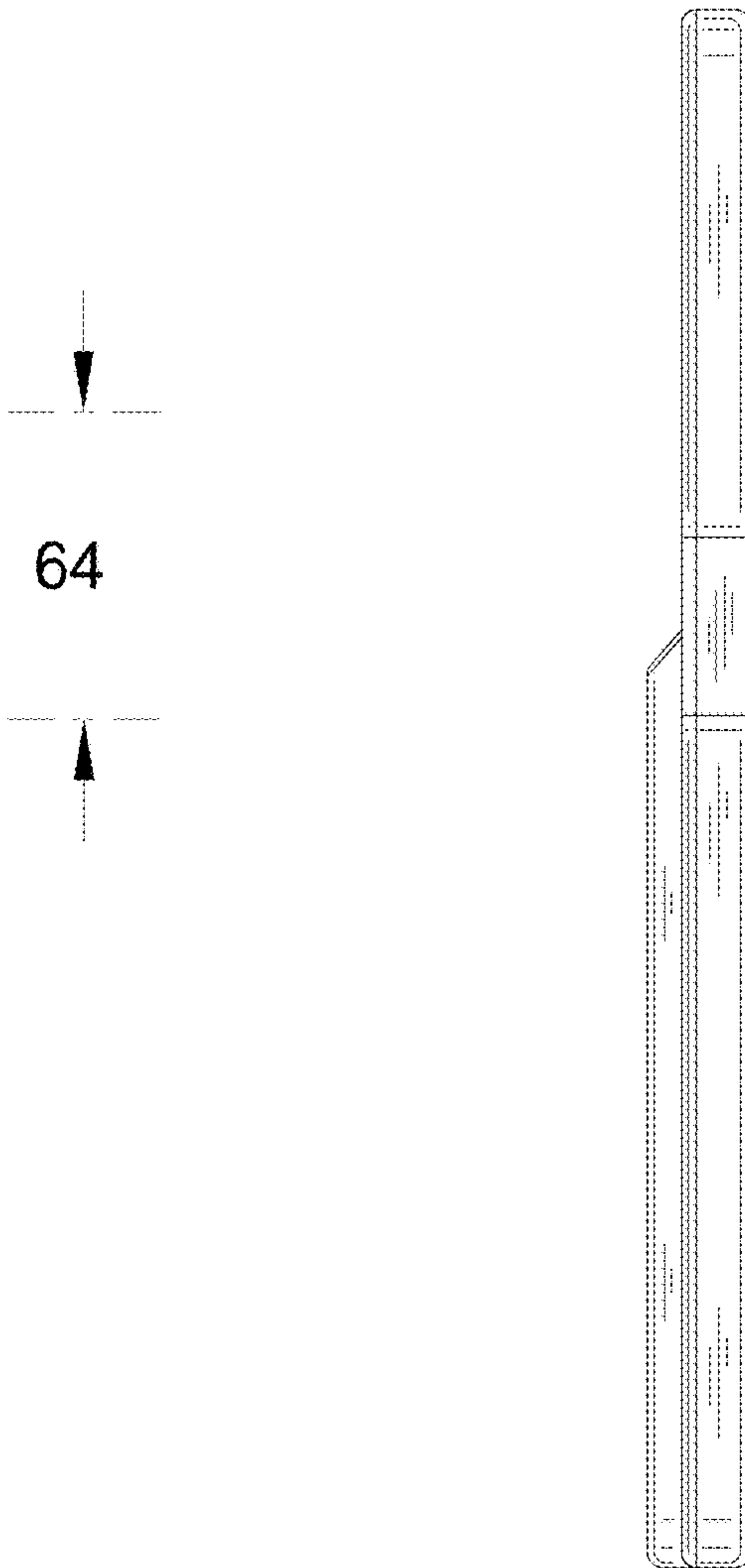

FIG.62

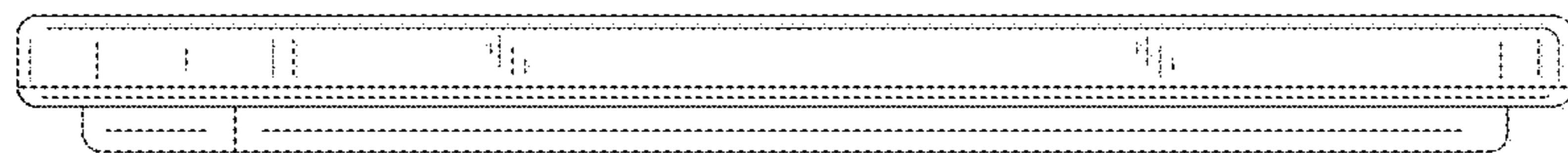

FIG.63

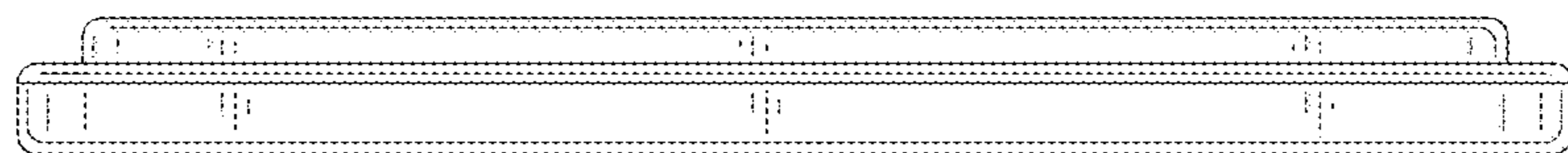

FIG.65

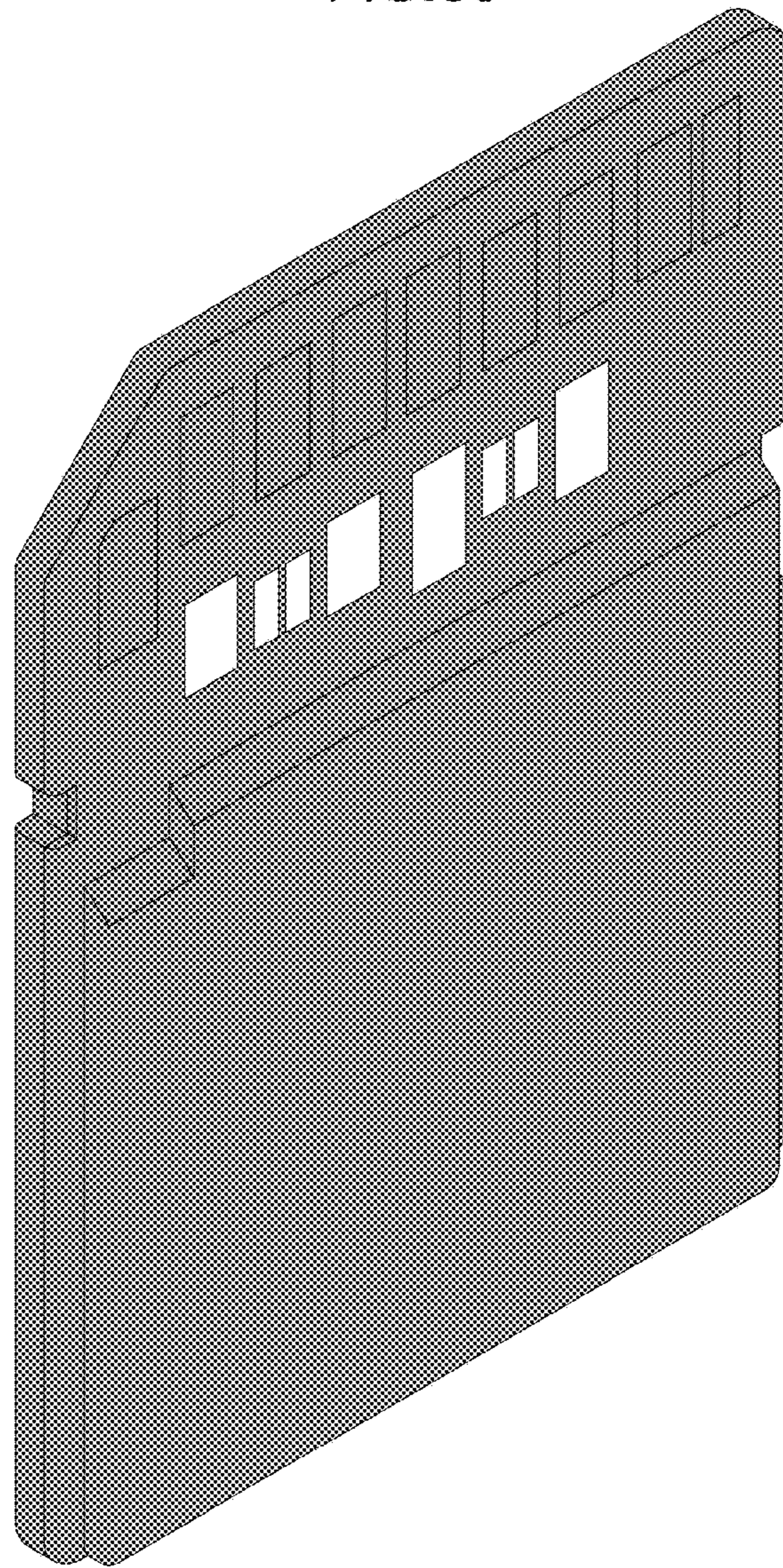

FIG.66

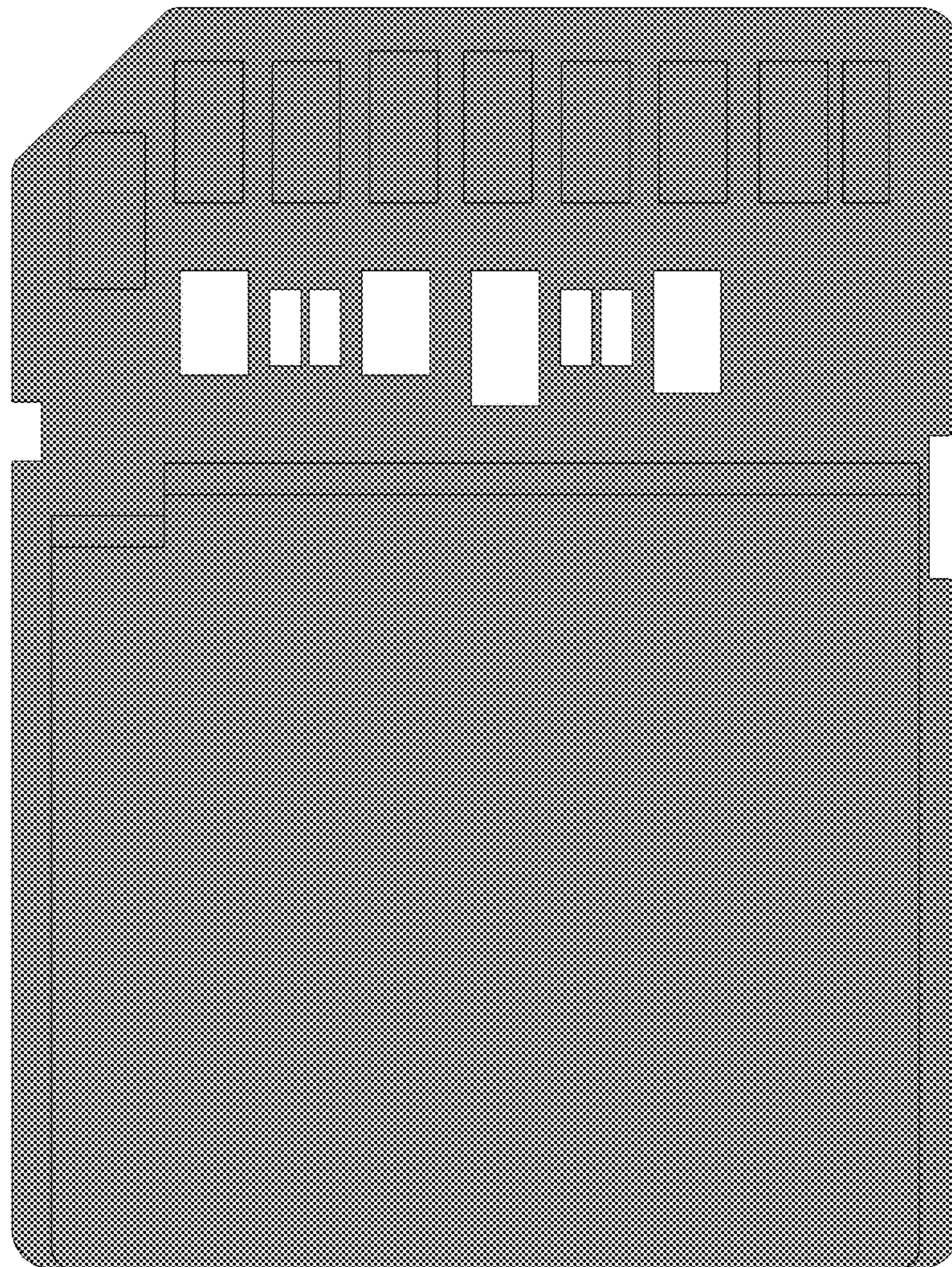

FIG.67



FIG.68

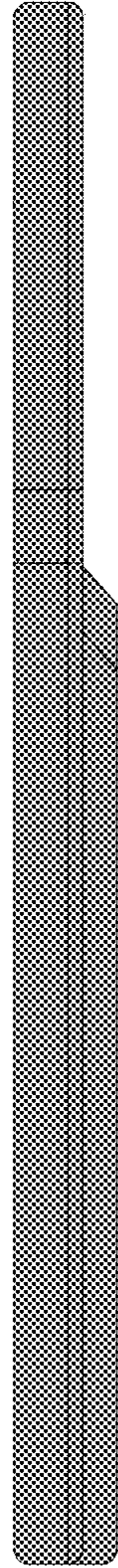

FIG.69

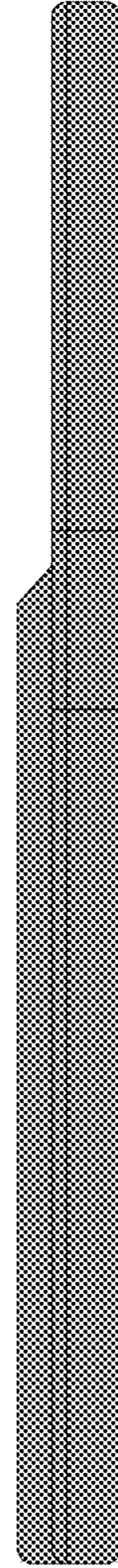

FIG.70

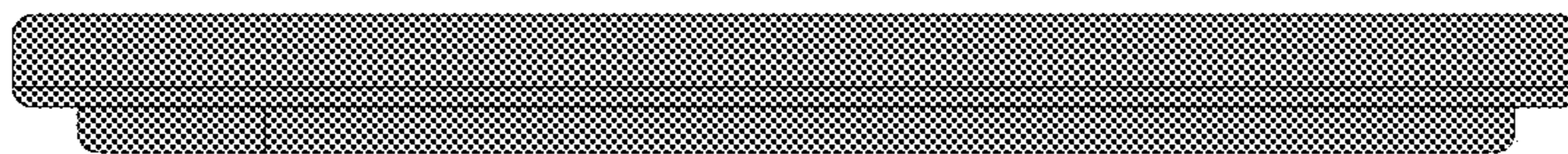

FIG.71

