



US00D848424S

(12) **United States Design Patent**
Kujawski et al.

(10) **Patent No.:** **US D848,424 S**

(45) **Date of Patent:** **** May 14, 2019**

- (54) **CONTROLLER DEVICE**
- (71) Applicant: **Microsoft Corporation**, Redmond, WA (US)
- (72) Inventors: **Christopher Kujawski**, Seattle, WA (US); **Robert Bryce Johnson**, Sammamish, WA (US)
- (73) Assignee: **Microsoft Corporation**, Redmond, WA (US)

- 6,586,666 B2 * 7/2003 Abe G10H 1/0016
84/411 R
- D487,466 S * 3/2004 Yokota D14/400
- D525,262 S * 7/2006 Boswell D14/454
- 7,193,165 B2 * 3/2007 Kawanobe A63F 13/08
200/18
- D556,759 S * 12/2007 Kawanobe D14/401
- D615,624 S * 5/2010 Allard D10/49
- D644,644 S * 9/2011 Wang D14/415
- D709,882 S 7/2014 Morris et al.
- D725,152 S * 3/2015 Wong D14/203.3
- D740,369 S * 10/2015 Cho D21/333

(**) Term: **15 Years**

- (21) Appl. No.: **29/642,615**
- (22) Filed: **Mar. 30, 2018**
- (51) **LOC (11) Cl.** **14-02**
- (52) **U.S. Cl.**
USPC **D14/401**; D14/388; D14/218
- (58) **Field of Classification Search**
USPC D14/400–418, 426–431, 454–455, 203.3,
D14/218, 300, 356, 383, 388, 399, 432,
D14/358; D21/331, 333, 566, 572–574,
D21/324, 328; D22/100, 103–105;
D13/162, 162.1, 168; D10/78, 98, 103;
D26/46, 48
CPC .. A63F 9/02; A63F 9/24; A63F 9/0291; A63F
9/0252; A63F 13/00; A63H 5/04; F41J
5/02
See application file for complete search history.

- (56) **References Cited**
U.S. PATENT DOCUMENTS
D325,225 S * 4/1992 Adhida D14/401
D336,315 S * 6/1993 Kitaue D21/331
D350,782 S * 9/1994 Barr D14/401
D373,137 S * 8/1996 Nakada D14/401
D376,180 S * 12/1996 Takahata D14/401
D432,995 S * 10/2000 Hubler D13/162
D453,932 S 2/2002 Han et al.

OTHER PUBLICATIONS
Xbox Adaptive Controller, online, no post date, <URL: <https://www.xbox.com/en-US/xbox-one/accessories/controllers/xbox-adaptive-controller> >, retrieved Dec. 4, 2018.*
(Continued)

Primary Examiner — Jeffrey D Asch
Assistant Examiner — Rebekah A Caruso
(74) *Attorney, Agent, or Firm* — Banner & Witcoff, Ltd.

(57) **CLAIM**
The ornamental design for a controller device, as shown and described.

DESCRIPTION
FIG. 1 is a top rear perspective view of a controller device showing our new design;
FIG. 2 is a top view thereof;
FIG. 3 is a bottom view thereof;
FIG. 4 is a front view thereof;
FIG. 5 is a rear view thereof;
FIG. 6 is a right side view thereof; and,
FIG. 7 is a left side view thereof.
The broken-line showing of the various unshaded elements of the controller device illustrates environmental structure and forms no part of the claimed design.

1 Claim, 7 Drawing Sheets

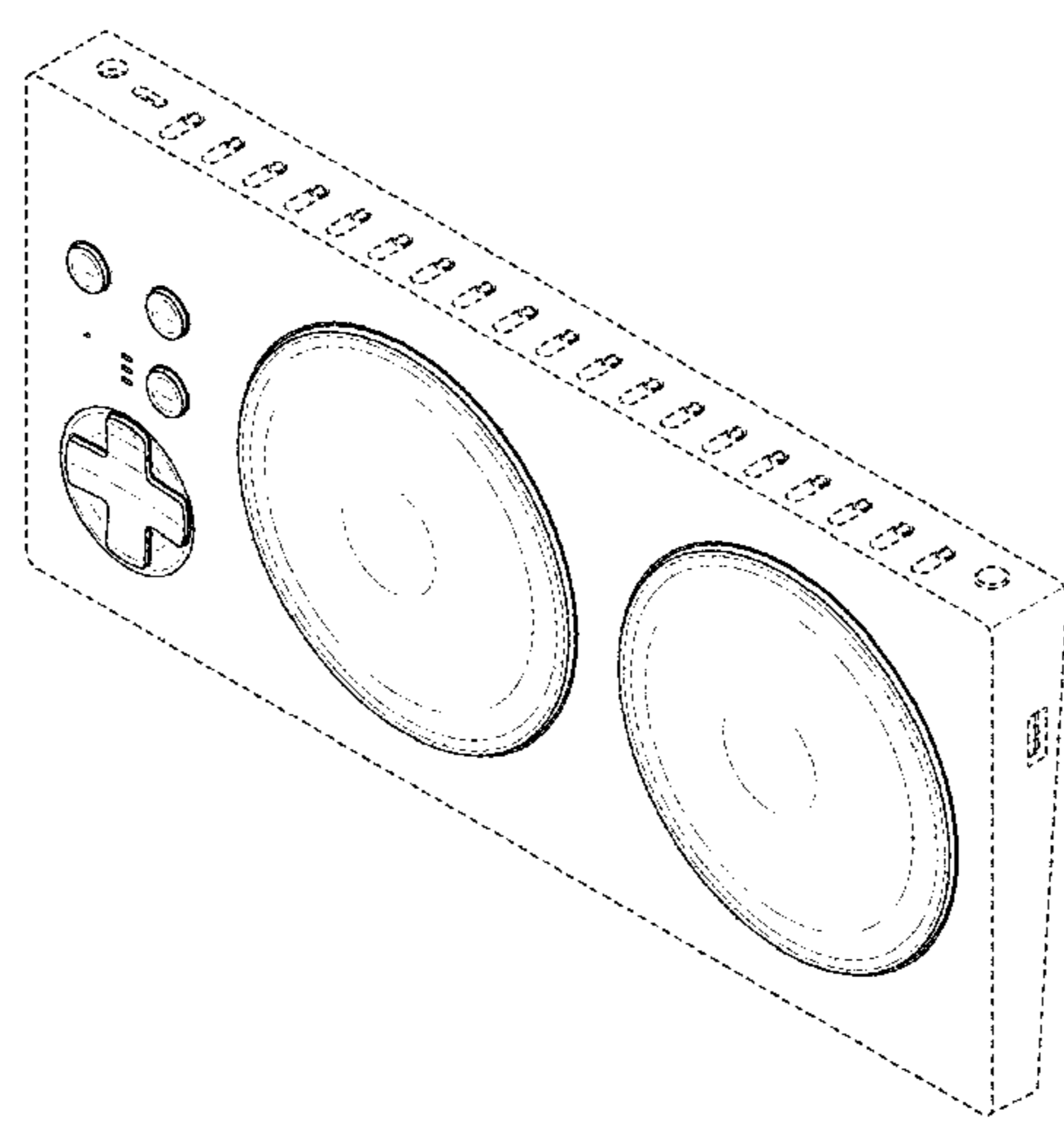

(56)

References Cited

U.S. PATENT DOCUMENTS

9,176,325 B2 * 11/2015 Lyons G02B 27/0172
 D766,376 S 9/2016 Kujawski et al.

OTHER PUBLICATIONS

“Xbox Adaptive Controller first look: A new, necessary gamepad,” Xbox Adaptive Controller pictured therein, online, post date May 17, 2018, <URL: <https://www.engadget.com/2018/05/17/xbox-adaptive-controller-disabilities-gamepad-microsoft-tour/>>, retrieved Dec. 4, 2018.*

Microsoft Xbox; “Xbox Wireless Controller—Ocean Shadow Special Edition”; Publication date unknown but prior to filing date of present application; Date Accessed: Apr. 11, 2018; URL: <<https://www.xbox.com/en-US/xbox-one/accessories/controllers/ocean-shadow-special-edition>>.

Microsoft Xbox; “Xbox Wireless Controller—Blue”; Publication date unknown but prior to filing date of present application; Date Accessed: Apr. 11, 2018; URL: <<https://www.xbox.com/en-US/xbox-one/accessories/controllers/blue-wireless-controller>>.

Gizmodo; “Master Mobile Gaming With This Upgraded Bluetooth NES Controller”; Publication date Jul. 24, 2014; Date Accessed:

Apr. 11, 2018; URL: <<https://www.gizmodo.com.au/2014/07/master-mobile-gaming-with-this-upgraded-bluetooth-nes-controller/>>.

The Verge; “The SNES Classic’s controller cables are two feet longer than the NES Classic”; Publication date Jun. 26, 2017; Date Accessed: Apr. 11, 2018; URL: <<https://www.theverge.com/circuitbreaker/2017/6/26/15875718/nintendo-snes-classic-controller-cable-length>>.

Dad Does; “Review: EZ Pro DJ Mixer Turntable, Can This Toy Turn You Into a Great DJ?”; Publication date Sep. 30, 2013; Date Accessed: Apr. 11, 2018; URL: <<http://www.daddoes.com/9487/review-ez-pro-dj-mixer-turntable/>>.

Digital DJ Tips; “Pioneer DJ DDJ-WeGO4 Review”; Publication date Dec. 5, 2016; Date Accessed: Apr. 11, 2018; URL: <<https://www.digitaldjtips.com/reviews/pioneer-dj-ddj-wego4/>>.

Engadget; “DJ Hero 2 brings two turntables and a microphone this Fall”; Publication date Jun. 8, 2010; Date Accessed: Apr. 11, 2018; URL: <<https://www.engadget.com/2010/06/08/dj-hero-2-brings-two-turntables-and-a-microphone-this-fall/>>.

NintendoLife; “Hardware Review: The Retro-Bit RES Plus Gives You a HDMI NES for Under 40 Dollars”; Publication date Aug. 29, 2017; Date Accessed: Apr. 11, 2018; URL: <http://www.nintendolife.com/news/2017/08/hardware_review_the_retro-bit_res_plus_gives_you_a_hdmi_nes_for_under_40_dollars>.

* cited by examiner

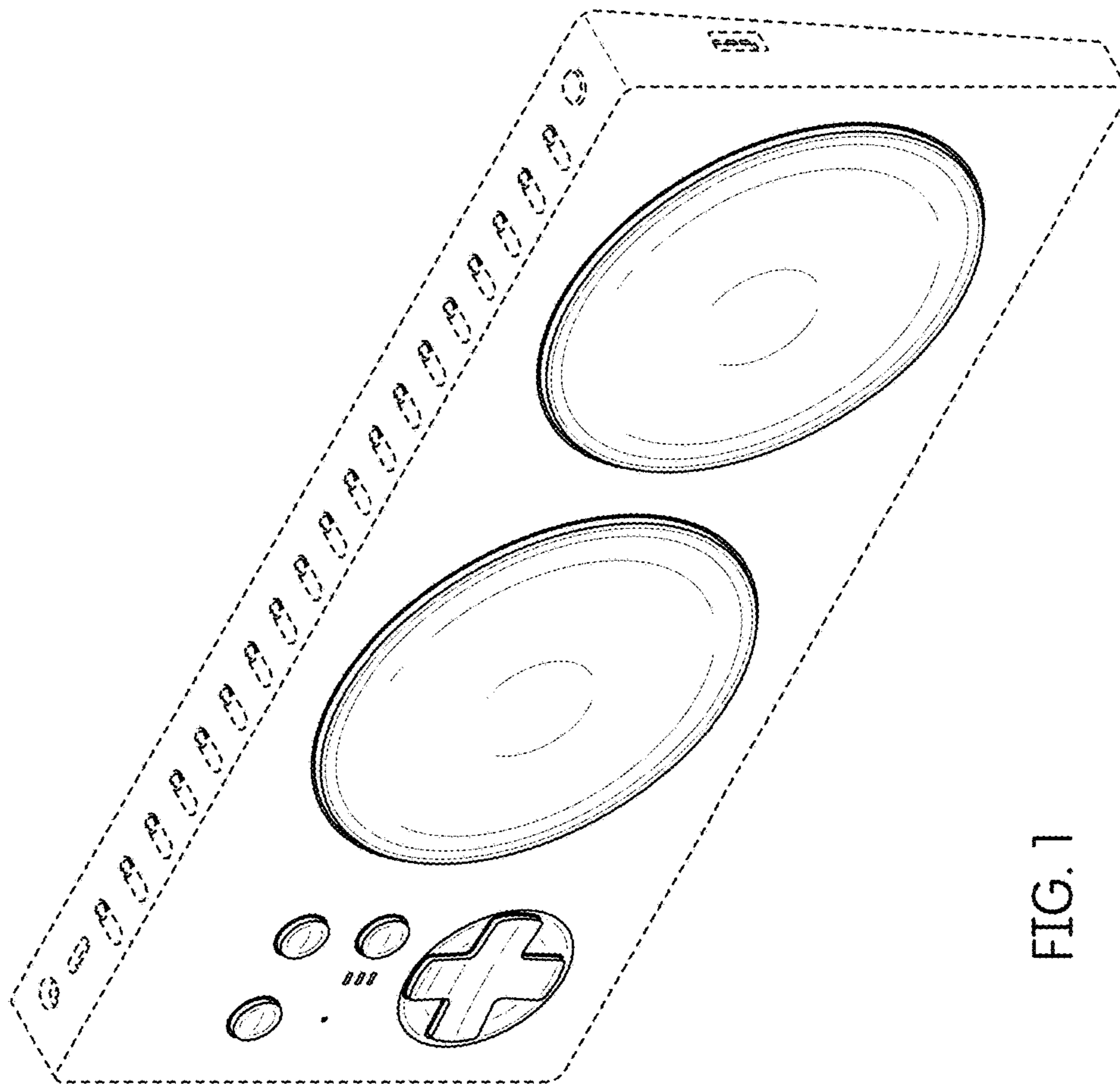

FIG. 1

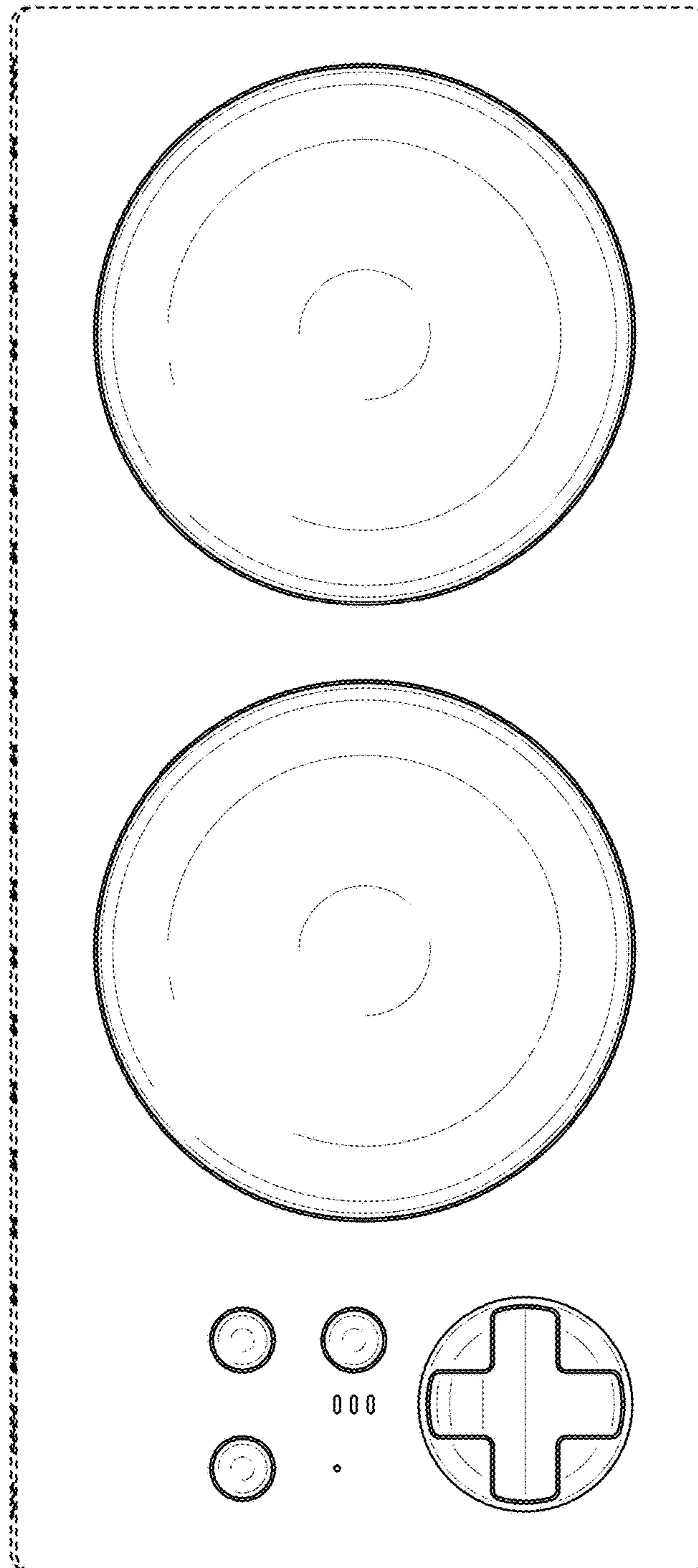

FIG. 2

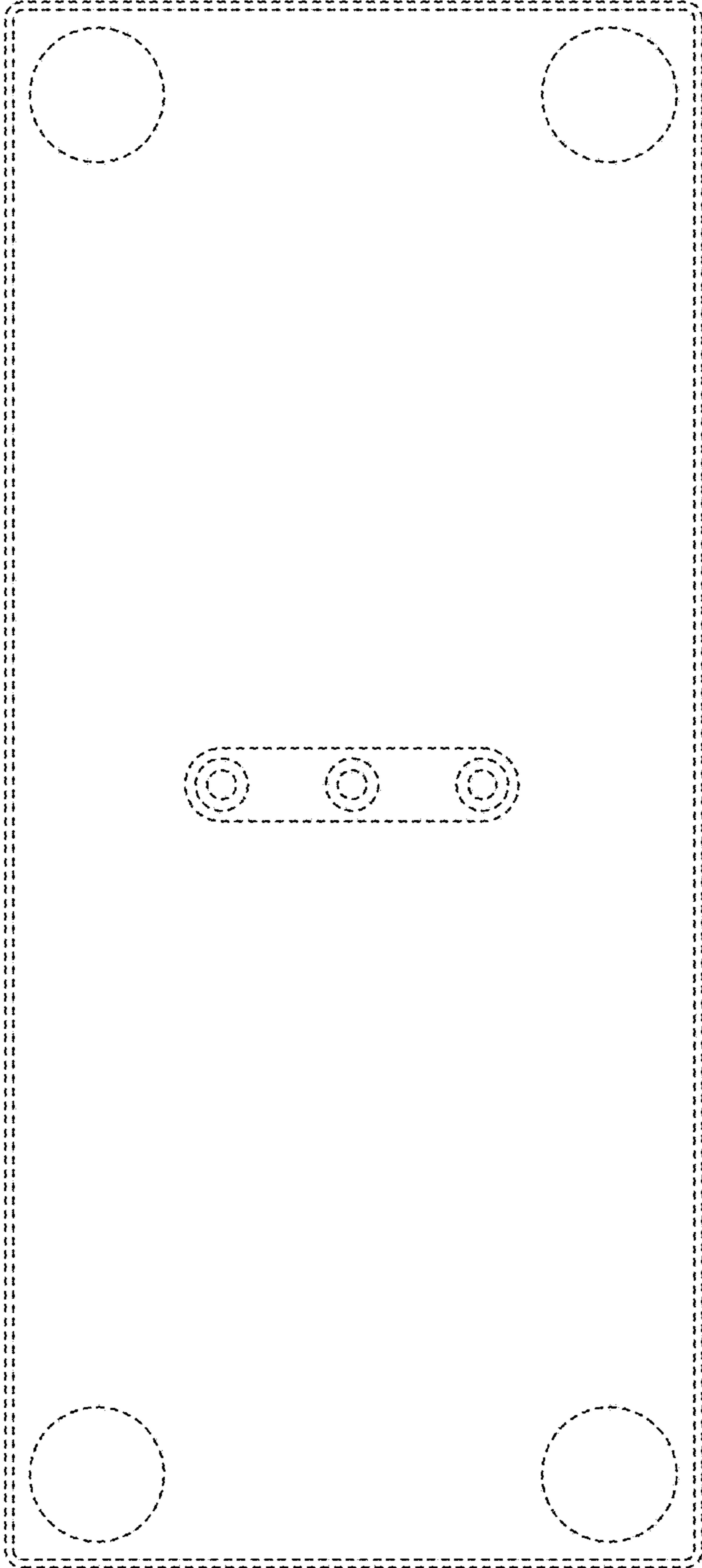

FIG. 3

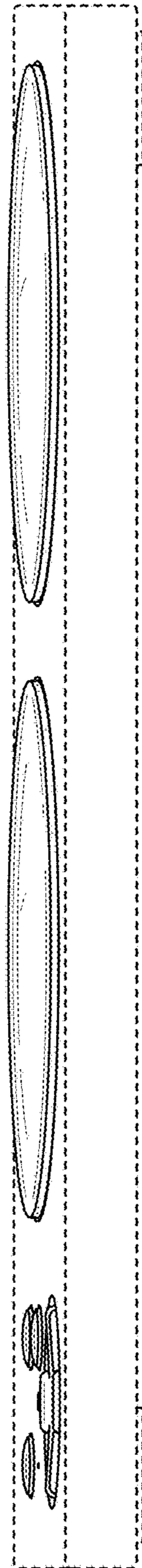

FIG. 4

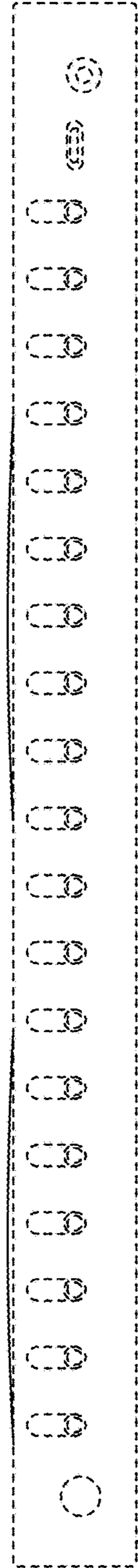

FIG. 5

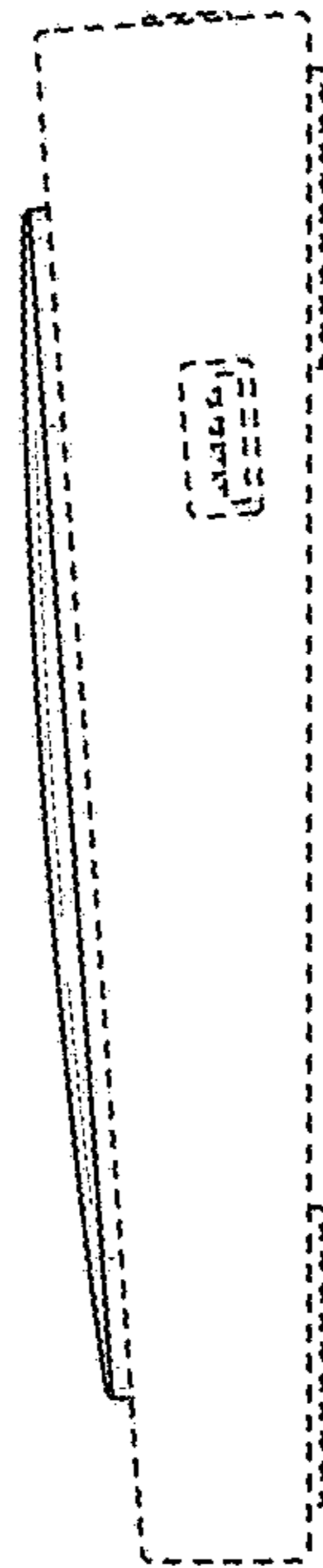

FIG. 6

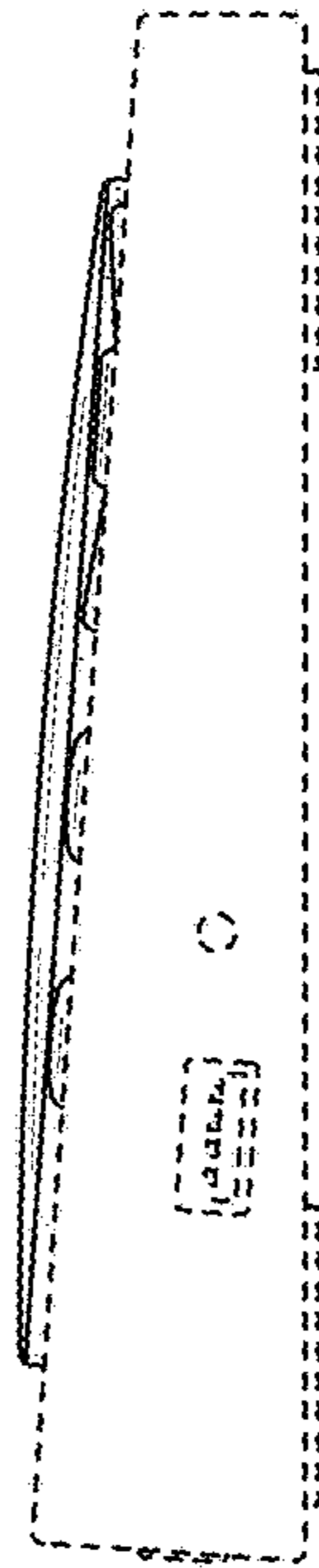

FIG. 7