



US00D848423S

(12) **United States Design Patent**  
**Kujawski et al.**

(10) **Patent No.:** **US D848,423 S**

(45) **Date of Patent:** **\*\* May 14, 2019**

- (54) **CONTROLLER DEVICE**
- (71) Applicant: **Microsoft Corporation**, Redmond, WA (US)
- (72) Inventors: **Christopher Kujawski**, Seattle, WA (US); **Robert Bryce Johnson**, Sammamish, WA (US); **Malcolm Goodrich**, Redmond, WA (US)
- (73) Assignee: **Microsoft Corporation**, Redmond, WA (US)

- 6,586,666 B2 \* 7/2003 Abe ..... G10H 1/0016  
84/411 R
  - D487,466 S \* 3/2004 Yokota ..... D14/400
  - D525,262 S \* 7/2006 Boswell ..... D14/454
  - 7,193,165 B2 \* 3/2007 Kawanobe ..... A63F 13/08  
200/18
  - D556,759 S \* 12/2007 Kawanobe ..... D14/401
  - D615,624 S \* 5/2010 Allard ..... D10/49
  - D644,644 S \* 9/2011 Wang ..... D14/415
  - D709,882 S 7/2014 Morris et al.
  - D725,152 S \* 3/2015 Wong ..... D14/203.3
- (Continued)

- (\*\*) Term: **15 Years**
- (21) Appl. No.: **29/642,612**
- (22) Filed: **Mar. 30, 2018**
- (51) **LOC (11) Cl.** ..... **14-02**
- (52) **U.S. Cl.**  
USPC ..... **D14/401**; D14/388; D14/218
- (58) **Field of Classification Search**  
USPC .... D14/400-418, 426-431, 454-455, 203.3,  
D14/218, 300, 356, 383, 388, 399, 432,  
D14/358; D21/331, 333, 566, 572-574,  
D21/324, 328; D22/100, 103-105;  
D13/162, 162.1, 168; D10/78, 98, 103;  
D26/46, 48  
CPC .. A63F 9/02; A63F 9/24; A63F 9/0291; A63F  
9/0252; A63F 13/00; A63H 5/04; F41J  
5/02  
See application file for complete search history.

(56) **References Cited**

**U.S. PATENT DOCUMENTS**

- D325,225 S \* 4/1992 Adhida ..... D14/401
- D336,315 S \* 6/1993 Kitaue ..... D21/331
- D350,782 S \* 9/1994 Barr ..... D14/401
- D373,137 S \* 8/1996 Nakada ..... D14/401
- D376,180 S \* 12/1996 Takahata ..... D14/401
- D432,995 S \* 10/2000 Hubler ..... D13/162
- D453,932 S 2/2002 Han et al.

**OTHER PUBLICATIONS**

Xbox Adaptive Controller, online, no post date, <URL: <https://www.xbox.com/en-US/xbox-one/accessories/controllers/xbox-adaptive-controller>>, retrieved Dec. 4, 2018.\*

(Continued)

*Primary Examiner* — Jeffrey D Asch

*Assistant Examiner* — Rebekah A Caruso

(74) *Attorney, Agent, or Firm* — Banner & Witcoff, Ltd.

(57) **CLAIM**

The ornamental design for a controller device, as shown and described.

**DESCRIPTION**

FIG. 1 is a top rear perspective view of a controller device showing our new design;  
 FIG. 2 is a top view thereof;  
 FIG. 3 is a bottom view thereof;  
 FIG. 4 is a front view thereof;  
 FIG. 5 is a rear view thereof;  
 FIG. 6 is a right side view thereof; and,  
 FIG. 7 is a left side view thereof.  
 The broken-line showing of the various unshaded elements of the controller device illustrates environmental structure and forms no part of the claimed design.

**1 Claim, 7 Drawing Sheets**

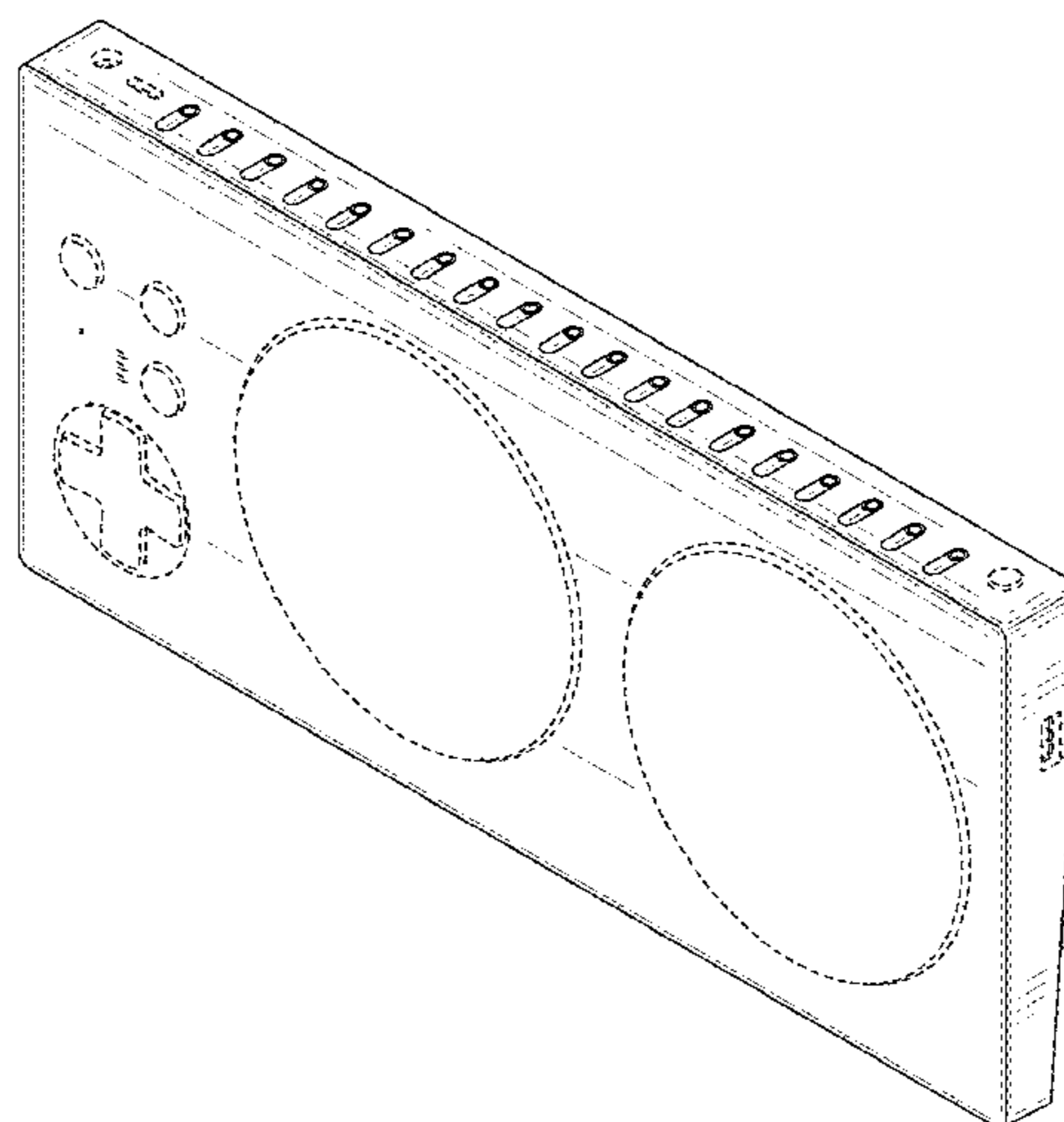

(56)

**References Cited**

## U.S. PATENT DOCUMENTS

D740,369 S \* 10/2015 Cho ..... D21/333  
 9,176,325 B2 \* 11/2015 Lyons ..... G02B 27/0172  
 D766,376 S 9/2016 Kujawski et al.

## OTHER PUBLICATIONS

“Xbox Adaptive Controller first look: A new, necessary gamepad,” Xbox Adaptive Controller pictured therein, online, post date May 17, 2018, <URL: <https://www.engadget.com/2018/05/17/xbox-adaptive-controller-disabilities-gamepad-microsoft-tour/>>, retrieved Dec. 4, 2018.\*

Microsoft Xbox; “Xbox Wireless Controller—Ocean Shadow Special Edition”; Publication date unknown but prior to filing date of present application; Date Accessed: Apr. 11, 2018; URL: <<https://www.xbox.com/en-US/xbox-one/accessories/controllers/ocean-shadow-special-edition>>.

Microsoft Xbox; “Xbox Wireless Controller—Blue”; Publication date unknown but prior to filing date of present application; Date Accessed: Apr. 11, 2018; URL: <<https://www.xbox.com/en-US/xbox-one/accessories/controllers/blue-wireless-controller>>.

Gizmodo; “Master Mobile Gaming With This Upgraded Bluetooth NES Controller”; Publication date Jul. 24, 2014; Date Accessed:

Apr. 11, 2018; URL: <<https://www.gizmodo.com.au/2014/07/master-mobile-gaming-with-this-upgraded-bluetooth-nes-controller/>>.

The Verge; “The SNES Classic’s controller cables are two feet longer than the NES Classic”; Publication date Jun. 26, 2017; Date Accessed: Apr. 11, 2018; URL: <<https://www.theverge.com/circuitbreaker/2017/6/26/15875718/nintendo-snes-classic-controller-cable-length>>.

Dad Does; “Review: EZ Pro DJ Mixer Turntable, Can This Toy Turn You Into a Great DJ?”; Publication date Sep. 30, 2013; Date Accessed: Apr. 11, 2018; URL: <<http://www.daddoes.com/9487/review-ez-pro-dj-mixer-turntable/>>.

Digital DJ Tips; “Pioneer DJ DDJ-WeGO4 Review”; Publication date Dec. 5, 2016; Date Accessed: Apr. 11, 2018; URL: <<https://www.digitaldjtips.com/reviews/pioneer-dj-ddj-wego4/>>.

Engadget; “DJ Hero 2 brings two turntables and a microphone this Fall”; Publication date Jun. 8, 2010; Date Accessed: Apr. 11, 2018; URL: <<https://www.engadget.com/2010/06/08/dj-hero-2-brings-two-turntables-and-a-microphone-this-fall/>>.

NintendoLife; “Hardware Review: The Retro-Bit RES Plus Gives You a HDMI NES for Under 40 Dollars”; Publication date Aug. 29, 2017; Date Accessed: Apr. 11, 2018; URL: <[http://www.nintendolife.com/news/2017/08/hardware\\_review\\_the\\_retro-bit\\_res\\_plus\\_gives\\_you\\_a\\_hdmi\\_nes\\_for\\_under\\_40\\_dollars](http://www.nintendolife.com/news/2017/08/hardware_review_the_retro-bit_res_plus_gives_you_a_hdmi_nes_for_under_40_dollars)>.

\* cited by examiner

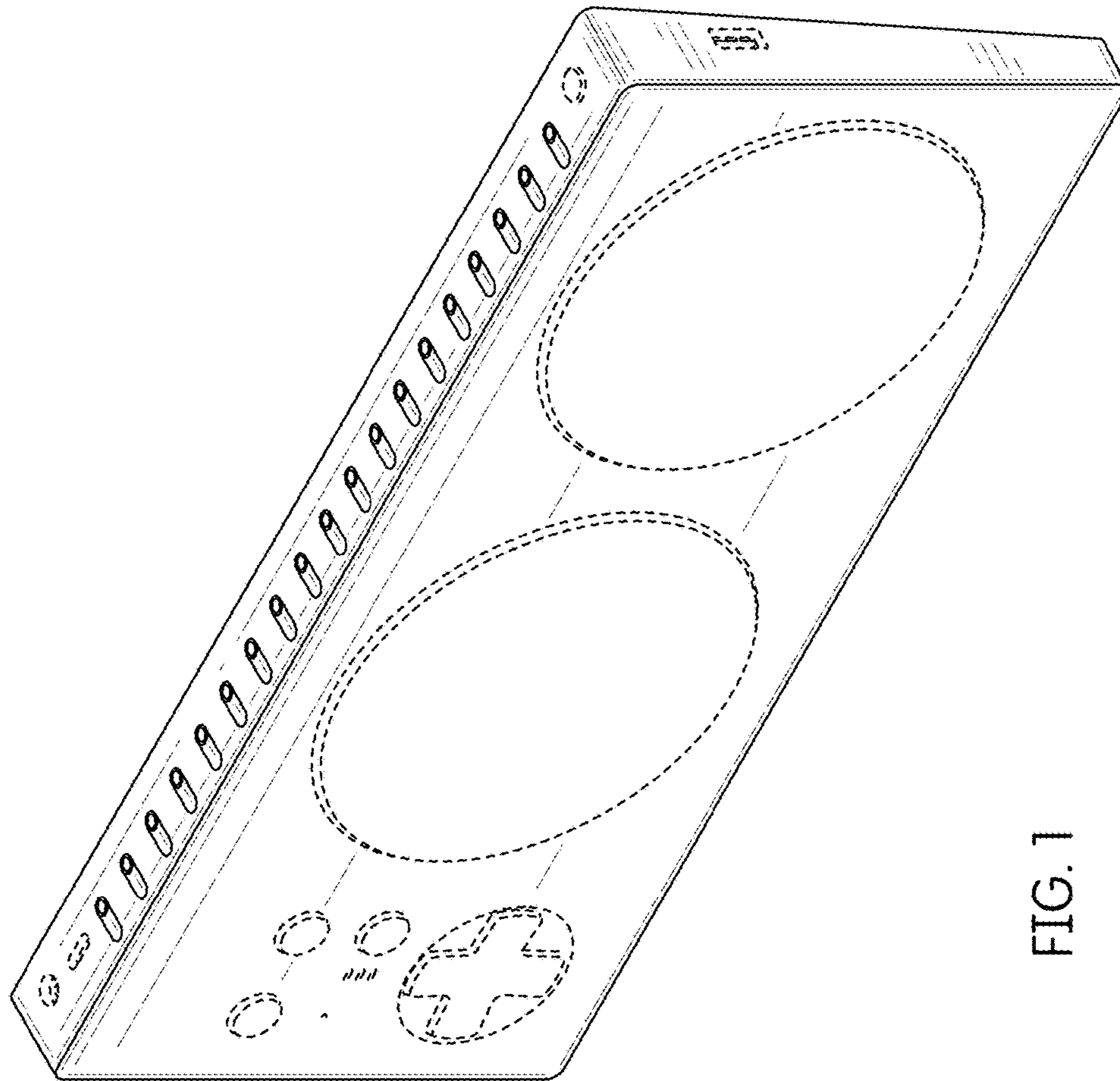

FIG. 1

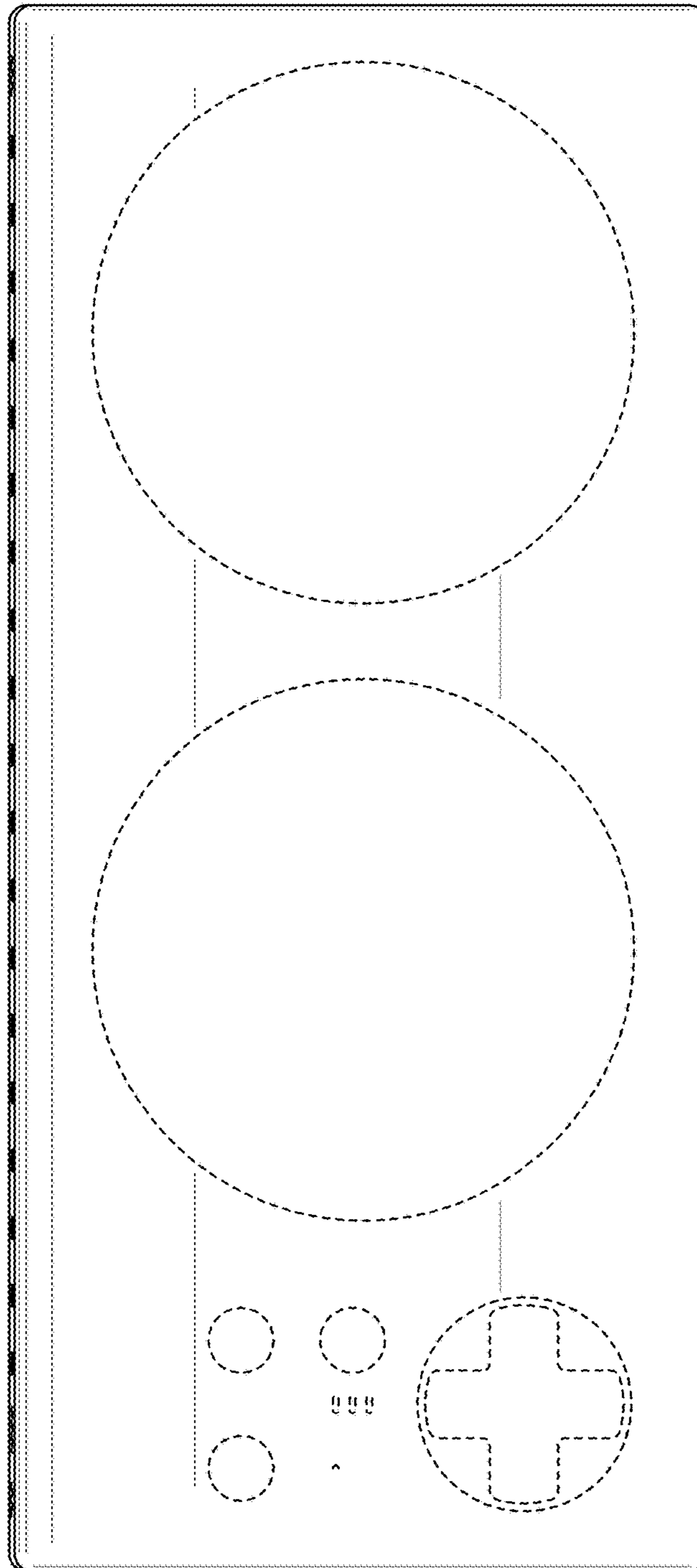

FIG. 2

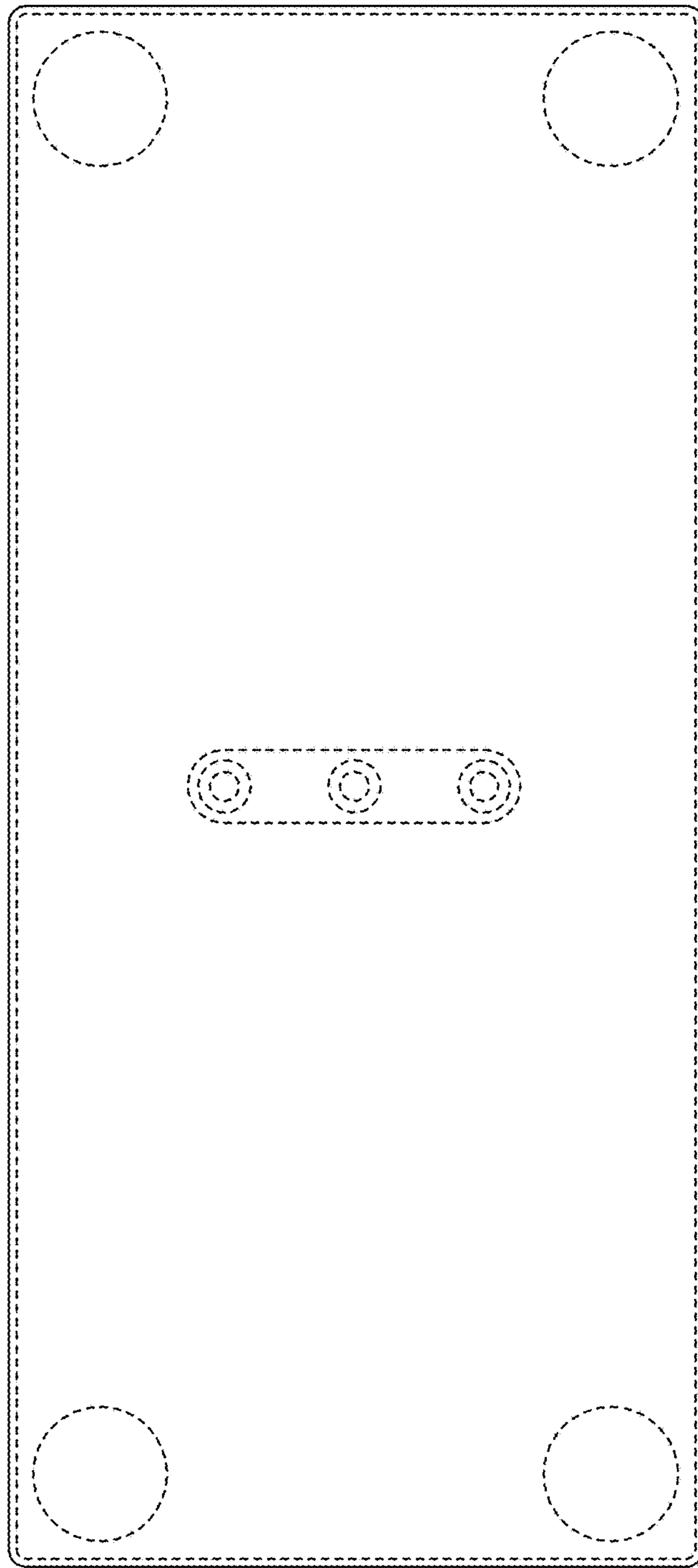

FIG. 3

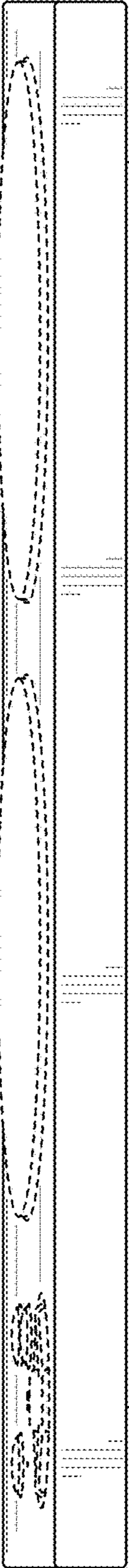

FIG. 4

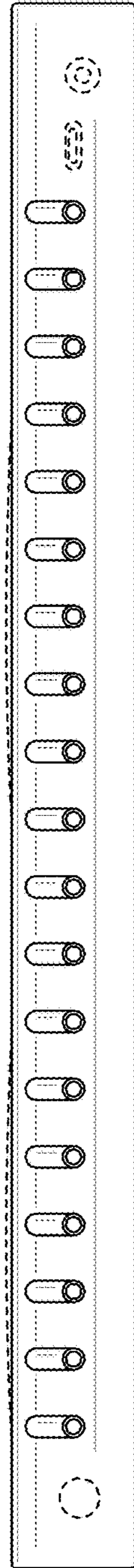

FIG. 5

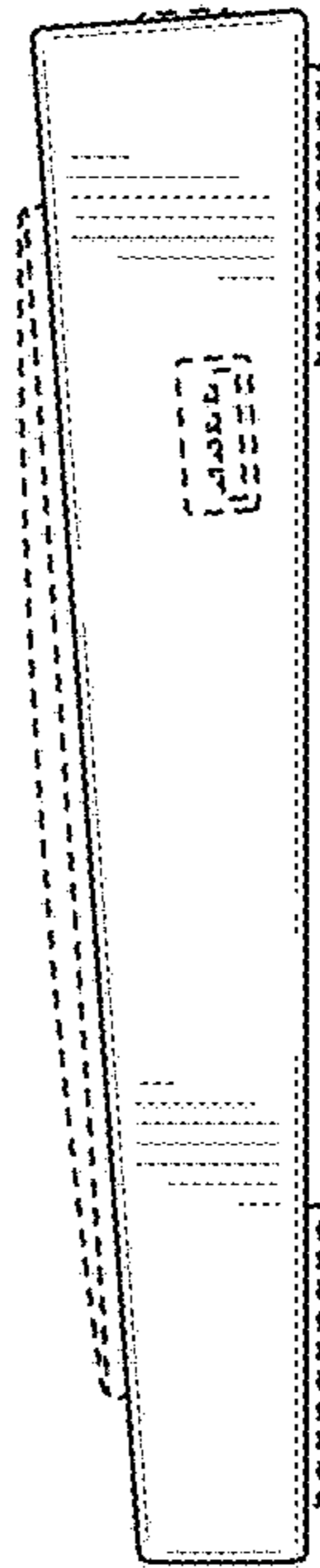

FIG. 6



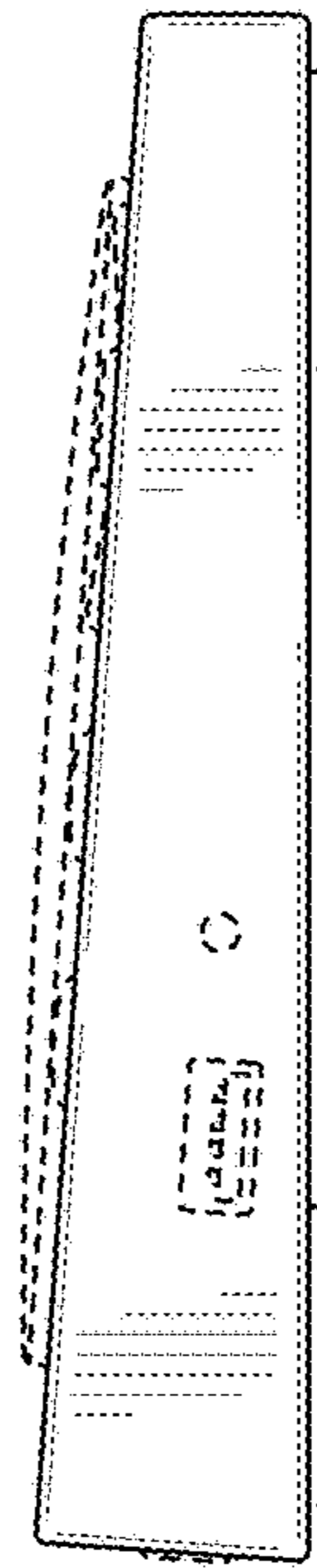

FIG. 7