



US00D848383S

(12) **United States Design Patent**
Meugnier et al.

(10) **Patent No.:** **US D848,383 S**

(45) **Date of Patent:** **** May 14, 2019**

(54) **PRINTED CIRCUIT BOARD**

(71) Applicant: **Fat Shark Technology SEZC**, George Town (KY)

(72) Inventors: **Jerome Meugnier**, Shenzhen (CN);
Gregory French, Shenzhen (CN);
Allan Evans, George Town (KY)

(73) Assignee: **Fat Shark Technology SEZC**, George Town, Grand Cayman (KY)

(**) Term: **15 Years**

(21) Appl. No.: **29/610,554**

(22) Filed: **Jul. 13, 2017**

(51) **LOC (11) Cl.** **13-03**

(52) **U.S. Cl.**

USPC **D13/182**; D21/599

(58) **Field of Classification Search**

USPC D13/182; 174/68.1, 250, 253, 255, 256;
318/567, 568.1; 361/600, 601, 718, 719,
361/720, 728, 736, 748, 751, 752, 760,
361/761, 807; 439/55, 65, 68, 76.1, 92,
439/93, 95; D11/117, 121, 131, 132,
D11/133, 134, 157, 158; D21/597, 599;
D9/606

CPC H05K 3/00; H05K 3/30; H05K 3/301;
H05K 3/303; H05K 3/34; H05K 3/3405;
H05K 3/341; H05K 3/36; H05K 3/361;
H05K 3/363; H05K 3/40; H05K 7/14;
H05K 7/1422; H05K 7/00; H05K 1/18;
H05K 1/02; H05K 1/181; H05K 1/182;
H05K 1/183; H05K 1/184; H05K 1/189;
H05K 1/00

See application file for complete search history.

(56) **References Cited**

U.S. PATENT DOCUMENTS

1,471,147 A * 10/1923 Dienner A63F 9/305
273/140

1,555,643 A * 9/1925 Donnell A63G 19/06
280/1.175
D244,559 S * 5/1977 Wells D21/374
D292,698 S * 11/1987 DeVita D13/182
D317,800 S * 6/1991 Laursen D21/599
D330,575 S * 10/1992 Kupperman D21/599
D334,696 S * 4/1993 Makris D21/599
D334,955 S * 4/1993 Kupperman D21/599
D353,687 S * 12/1994 Dacko D21/599
D430,856 S * 9/2000 Wilkerson D13/182
D472,382 S * 4/2003 Larsen D3/271.2
6,868,314 B1 3/2005 Frink

(Continued)

FOREIGN PATENT DOCUMENTS

EP 2499890 B1 4/2014
EP 2937123 A1 10/2015

(Continued)

Primary Examiner — Elizabeth J Oswecki

(74) *Attorney, Agent, or Firm* — Jacobsen IP Law

(57) **CLAIM**

The ornamental design for a printed circuit board, as shown and described.

DESCRIPTION

FIG. 1 is a top, left, front perspective view of a printed circuit board, showing our new design, in a used condition with an unmanned aerial vehicle shown in broken lines; FIG. 2 is a front view thereof, in an unused condition; FIG. 3 is a back view thereof; FIG. 4 is a right side view thereof; FIG. 5 is a left side view thereof; FIG. 6 is a top view thereof; and FIG. 7 is a bottom view thereof.

The broken lines shown in the drawings represent portions of the printed circuit board that form no part of the claimed design.

1 Claim, 5 Drawing Sheets

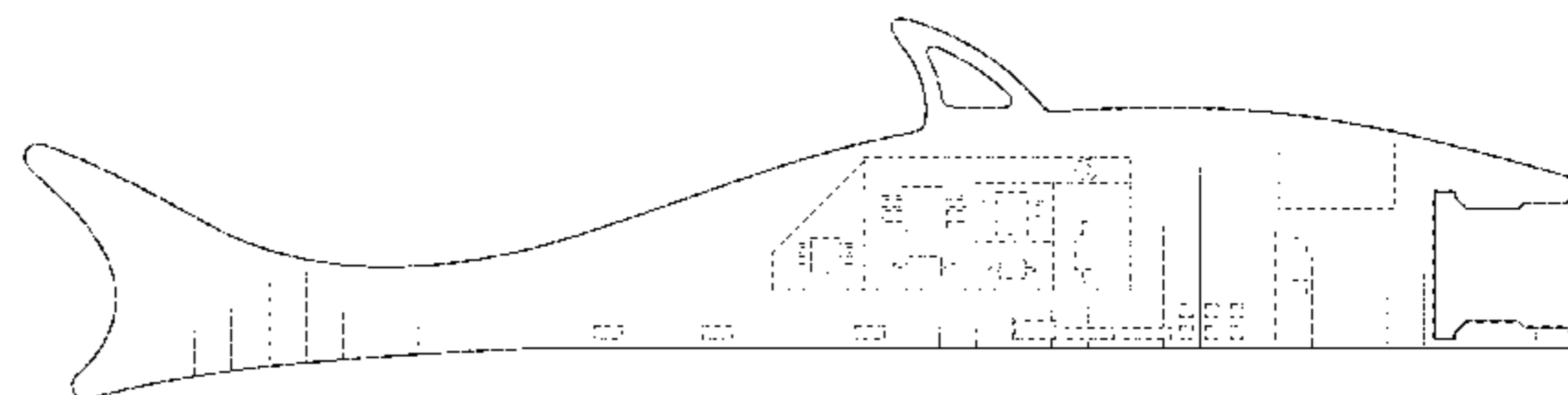
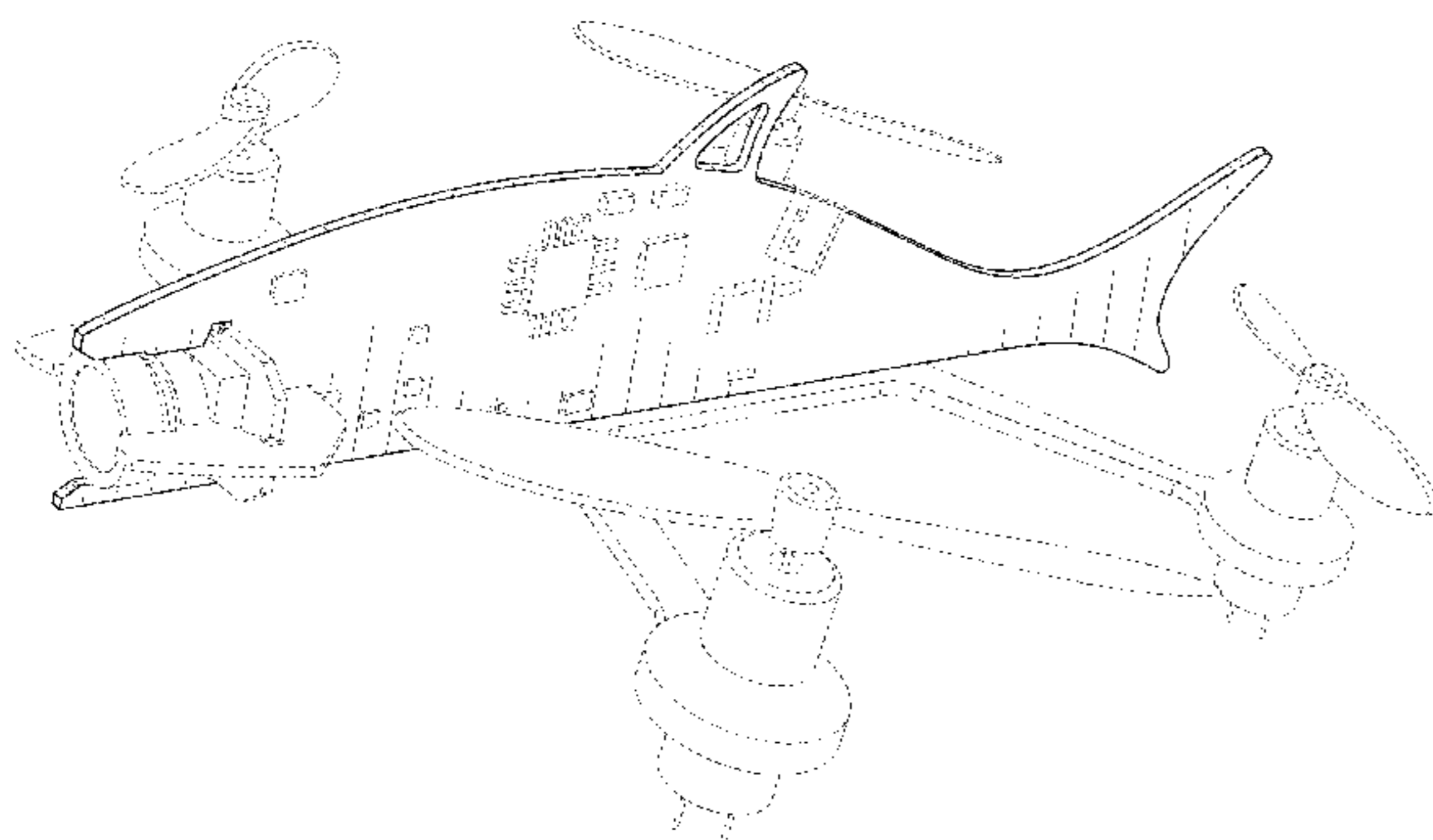

(56)

References Cited

U.S. PATENT DOCUMENTS

D508,681 S * 8/2005 Enderlein D13/182
 D525,213 S * 7/2006 Enderlein D13/182
 D557,356 S * 12/2007 Johnston D21/572
 D575,834 S * 8/2008 Welch D21/572
 D607,064 S * 12/2009 Thorsen D21/599
 D617,392 S * 6/2010 McLaughlin D21/427
 D639,756 S * 6/2011 Greene, Jr. D13/182
 7,962,252 B2 6/2011 Shams et al.
 D642,546 S * 8/2011 Greene, Jr. D13/182
 D647,072 S * 10/2011 Bentley D13/182
 D648,808 S 11/2011 Seydoux et al.
 D648,809 S 11/2011 Seydoux et al.
 D659,771 S 5/2012 Seydoux et al.
 8,201,773 B1 6/2012 Durham et al.
 8,242,623 B2 8/2012 Lucero et al.
 D677,341 S * 3/2013 English D21/439
 8,387,911 B2 3/2013 Collette
 D706,678 S 6/2014 Earon
 D710,452 S 8/2014 Barajas et al.
 8,903,568 B1 12/2014 Wang et al.
 8,991,758 B2 3/2015 Earon
 9,004,396 B1 4/2015 Colin et al.
 9,004,973 B2 4/2015 Condon et al.
 D729,694 S 5/2015 Earon
 D730,244 S 5/2015 Earon
 D731,002 S * 6/2015 Phillips D21/599
 9,070,101 B2 6/2015 Abhyanker
 9,096,314 B2 8/2015 Brotherton-Ratcliffe et al.
 D741,751 S 10/2015 Klaptocz et al.
 D741,779 S 10/2015 Hsiao et al.
 D745,435 S 12/2015 Park et al.
 9,213,046 B2 12/2015 Wang
 9,221,537 B2 12/2015 Wang et al.
 9,221,539 B2 12/2015 Christensen et al.
 D747,775 S 1/2016 Colin et al.
 D747,776 S * 1/2016 Norman D21/585
 9,233,754 B1 1/2016 Wang et al.
 D751,025 S 3/2016 Howell et al.
 D751,490 S 3/2016 Chen
 D751,491 S 3/2016 Chen
 D756,842 S 5/2016 Ashjaee
 D758,201 S * 6/2016 Sehl D21/599
 D759,764 S 6/2016 Lai
 9,376,208 B1 6/2016 Gentry
 D760,624 S 7/2016 Balaesque et al.
 D761,690 S 7/2016 Friesmuth
 D761,920 S 7/2016 Fargeau et al.
 D763,133 S 8/2016 Ketcher
 D763,134 S 8/2016 Wang
 D767,043 S 9/2016 Morrison
 D768,539 S 10/2016 Lee
 D768,540 S 10/2016 Ji et al.
 D768,789 S 10/2016 Fargeau et al.
 9,457,901 B2 10/2016 Bertrand et al.
 D770,572 S 11/2016 Caubel et al.
 D772,756 S 11/2016 Gambus et al.
 D772,991 S 11/2016 Caubel et al.
 D774,478 S 12/2016 Li
 D774,941 S 12/2016 Lupashin et al.
 D776,569 S 1/2017 Baruchin
 D776,570 S 1/2017 Baruchin
 D777,059 S 1/2017 Zhang et al.

D777,263 S 1/2017 Lavagen et al.
 9,550,400 B2 1/2017 Hutson
 D779,595 S 2/2017 Xiao
 D780,062 S 2/2017 Wu et al.
 D781,381 S 3/2017 Caubel et al.
 D782,365 S 3/2017 Hung
 D783,727 S 4/2017 Xiao
 D784,201 S 4/2017 Goldy
 D784,202 S 4/2017 Park
 D784,854 S 4/2017 Huang et al.
 9,623,969 B2 4/2017 Nelson
 9,630,714 B1 4/2017 Gohl et al.
 D785,717 S 5/2017 Xiao
 D787,372 S 5/2017 Ketcher
 D794,586 S * 8/2017 Takahashi D13/182
 D799,438 S * 10/2017 Takahashi D13/182
 D804,437 S * 12/2017 Kantor D13/182
 D824,865 S * 8/2018 Chen D13/182
 D825,381 S * 8/2018 Meugnier D12/16.1
 2007/0294889 A1 * 12/2007 Schmitt H01L 25/50
 29/831
 2008/0210809 A1 9/2008 Arlton et al.
 2009/0268390 A1 * 10/2009 King G06F 13/409
 361/679.33
 2009/0283629 A1 11/2009 Kroetsch et al.
 2015/0060606 A1 3/2015 Wang et al.
 2015/0259066 A1 9/2015 Johannesson et al.
 2015/0273351 A1 10/2015 Condon et al.
 2016/0016674 A1 1/2016 Zhao et al.
 2016/0130015 A1 5/2016 Caubel et al.
 2016/0185454 A1 6/2016 Hutson
 2016/0272317 A1 9/2016 Cho et al.
 2016/0291594 A1 10/2016 Zhao et al.
 2016/0301916 A1 10/2016 Zhang et al.
 2016/0304198 A1 10/2016 Jourdan
 2016/0349746 A1 12/2016 Grau
 2016/0351089 A1 12/2016 Salem
 2016/0368597 A1 12/2016 Medlock
 2017/0006148 A1 1/2017 Zhao
 2017/0021915 A1 1/2017 Vaughn et al.
 2017/0026626 A1 1/2017 Wang
 2017/0027077 A1 1/2017 Nicoloff
 2017/0034493 A1 2/2017 Wang
 2017/0036771 A1 2/2017 Woodman et al.
 2017/0041507 A1 2/2017 Chen et al.
 2017/0059704 A1 3/2017 Xie et al.
 2017/0064068 A1 3/2017 Liu et al.
 2017/0078553 A1 3/2017 Sron et al.
 2017/0084181 A1 3/2017 Wilson et al.
 2017/0094792 A1 3/2017 Dunkel et al.
 2017/0121034 A1 5/2017 Fisher et al.
 2017/0129601 A1 5/2017 Babel et al.
 2017/0133771 A1 5/2017 Xiao et al.

FOREIGN PATENT DOCUMENTS

EP 2965989 A1 1/2016
 WO 2013029286 A1 3/2013
 WO 2015036907 A1 3/2015
 WO 2016058120 A1 4/2016
 WO 2016161426 A1 10/2016
 WO 2016190994 A1 12/2016
 WO 2016193884 A1 12/2016
 WO 2017076079 A1 5/2017

* cited by examiner

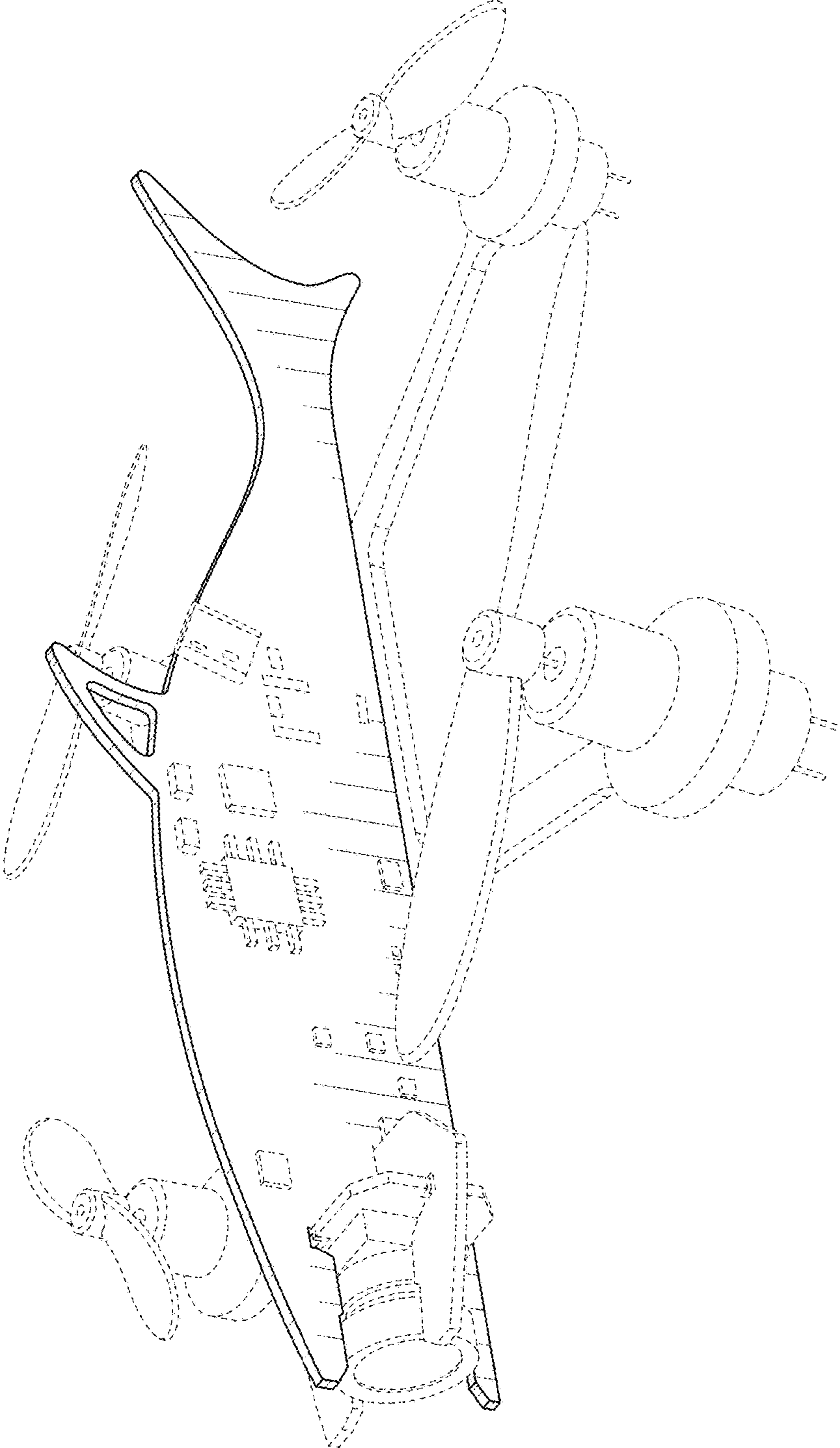

FIG. 1

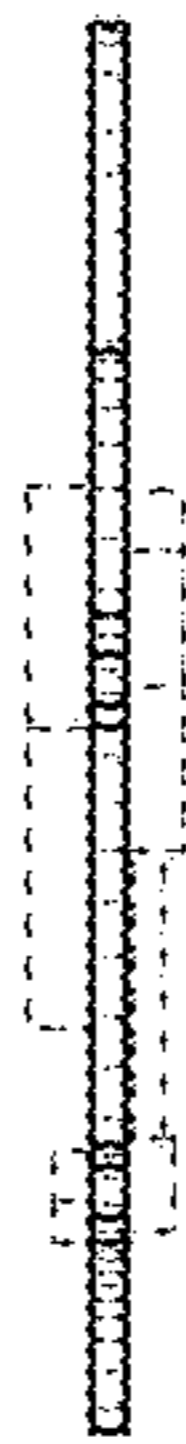

FIG. 2

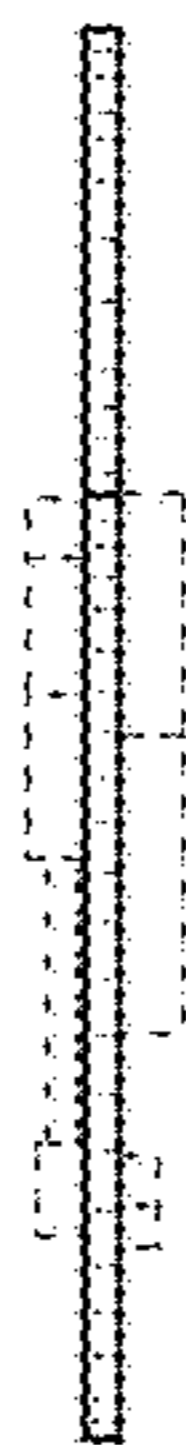

FIG. 3

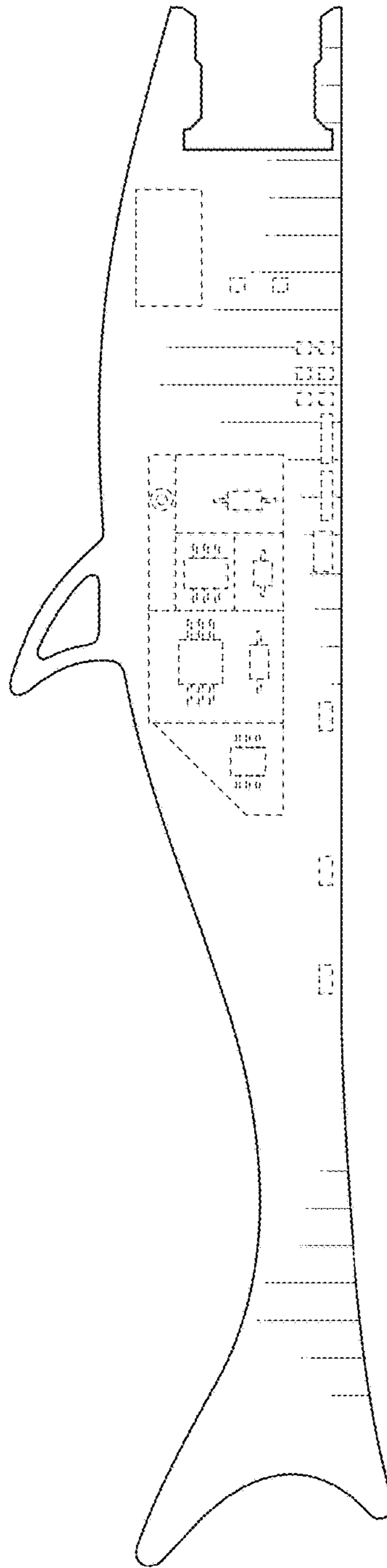

FIG. 4

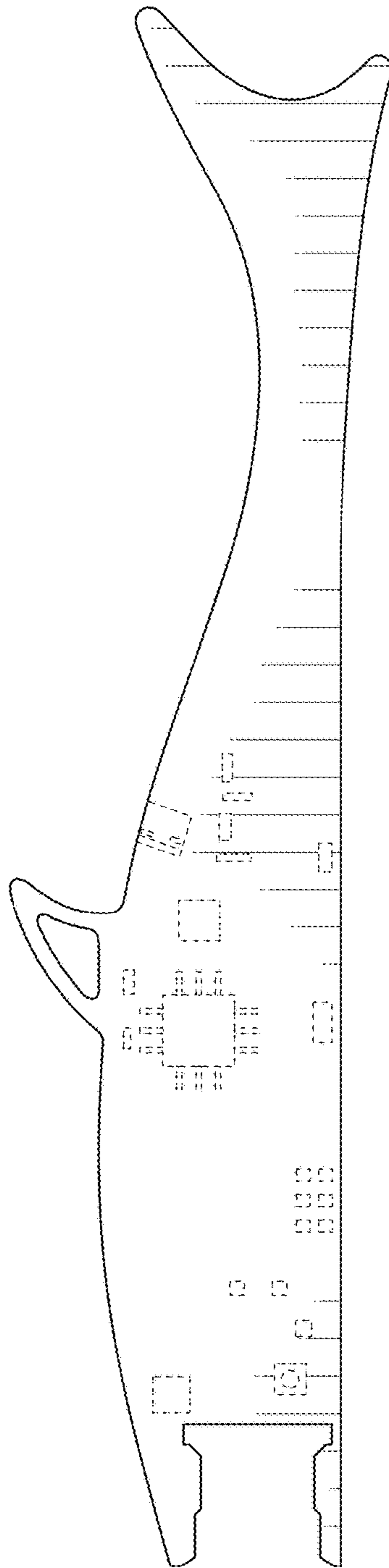

FIG. 5

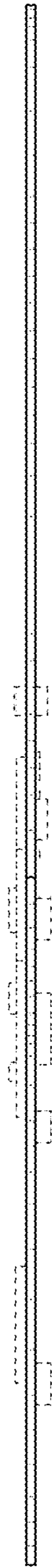

FIG. 6



FIG. 7