



US00D848313S

(12) **United States Design Patent** (10) **Patent No.:** **US D848,313 S**
Kanki (45) **Date of Patent:** **** May 14, 2019**

(54) **AUTOMOBILE AND/OR REPLICA THEREOF**

(71) Applicant: **HONDA MOTOR CO., LTD.**, Tokyo (JP)
(72) Inventor: **Takao Kanki**, Wako (JP)
(73) Assignee: **HONDA MOTOR CO., LTD.**, Tokyo (JP)

(**) Term: **15 Years**

(21) Appl. No.: **29/608,665**

(22) Filed: **Jun. 23, 2017**

(30) **Foreign Application Priority Data**

Dec. 26, 2016 (JP) 2016-028087

(51) **LOC (11) Cl.** **12-08**

(52) **U.S. Cl.**
USPC **D12/88**

(58) **Field of Classification Search**
USPC D12/86, 88, 91, 92, 169, 214, 215, 407,
D12/16.1, 300, 305, 317, 319, 328, 344,
D12/345, 406, 412, 413, 414, 414.1, 110,
D12/114, 126, 409, 410, 415, 115, 120,
(Continued)

(56) **References Cited**

U.S. PATENT DOCUMENTS

D358,569 S * 5/1995 Ramaciotti D12/92
D471,936 S * 3/2003 Tilbor D21/433
D524,876 S * 7/2006 Augustin D21/433

(Continued)

FOREIGN PATENT DOCUMENTS

JP D1429532 S 4/2012
JP D1445264 S 7/2012

(Continued)

OTHER PUBLICATIONS

Office Action dated Jul. 26, 2017, issued in counterpart Japanese Application No. 2016-028087 (2 pages).

Primary Examiner — Robin V Webster
Assistant Examiner — Rachel A Voorhies

(74) *Attorney, Agent, or Firm* — Westerman, Hattori,
Daniels & Adrian, LLP

(57) **CLAIM**

The ornamental design for an automobile and/or replica thereof, as shown and described.

DESCRIPTION

FIG. 1 is a front perspective view of the automobile and/or replica thereof as seen from the right side;
FIG. 2 is a rear perspective view of the automobile and/or replica thereof as seen from the right side;
FIG. 3 is a front view of the automobile and/or replica thereof;
FIG. 4 is a rear view of the automobile and/or replica thereof;
FIG. 5 is a top plan view of the automobile and/or replica thereof;
FIG. 6 is a right side view of the automobile and/or replica thereof;
FIG. 7 is a front perspective view of the automobile and/or replica thereof as seen from the right side;
FIG. 8 is a front perspective view of the automobile and/or replica thereof as seen from the left side;
FIG. 9 is a rear perspective view of the automobile and/or replica thereof as seen from the right side; and,
FIG. 10 is a rear perspective view of the automobile and/or replica thereof as seen from the left side.

The broken lines in the drawings illustrate portions of the automobile and/or replica thereof that form no part of the claimed design.

1 Claim, 5 Drawing Sheets

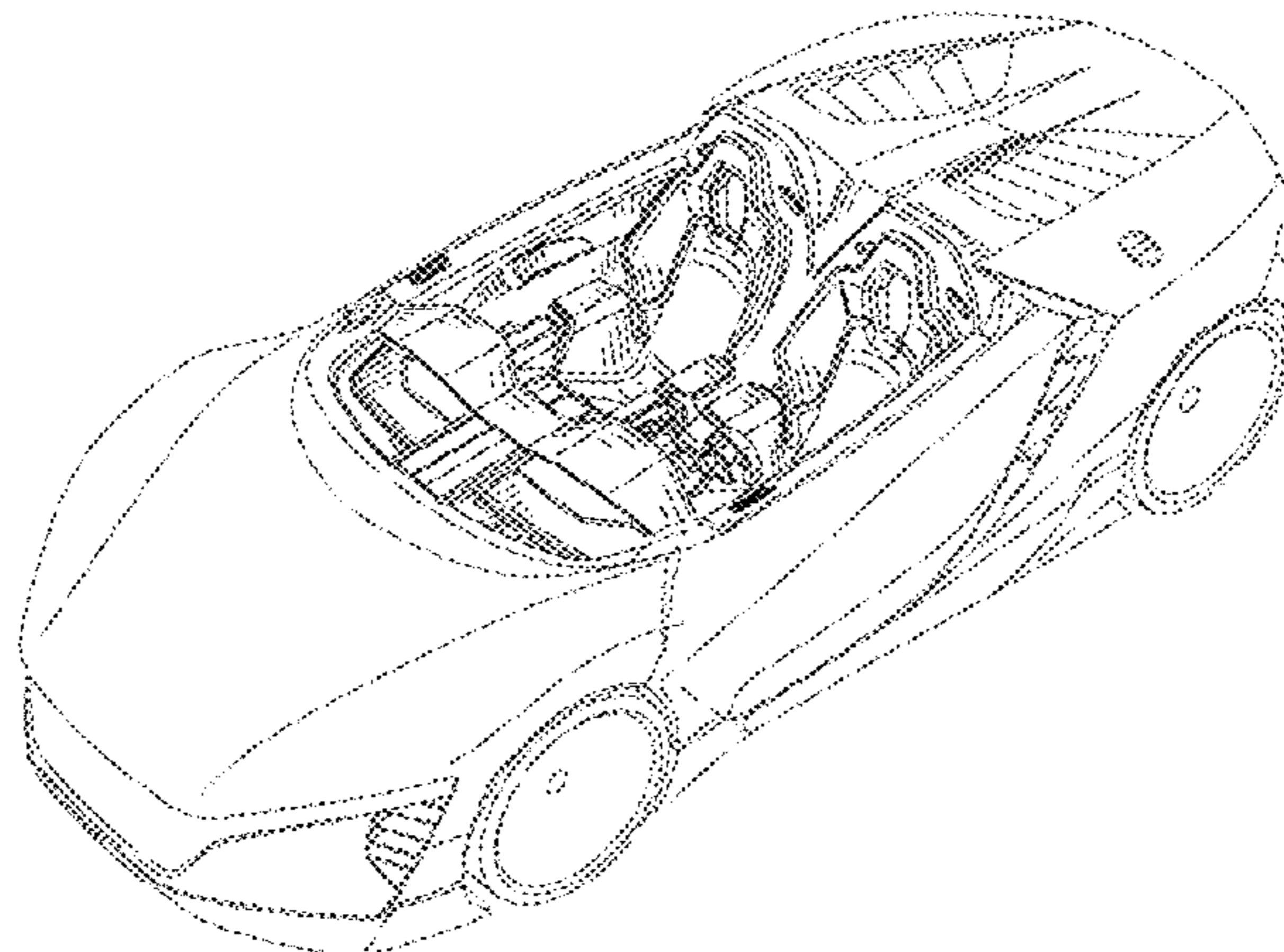

FIG.1

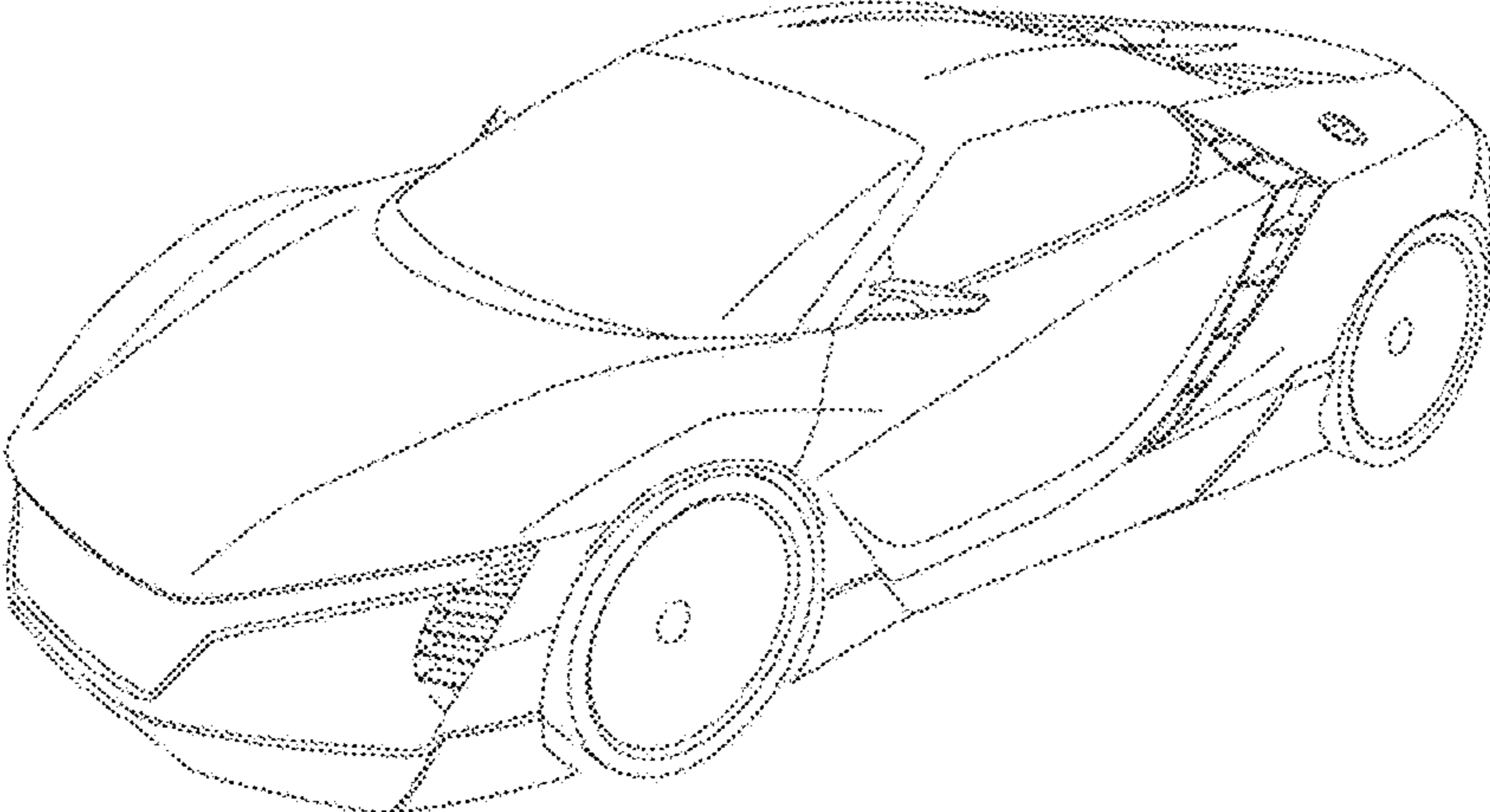

FIG.2

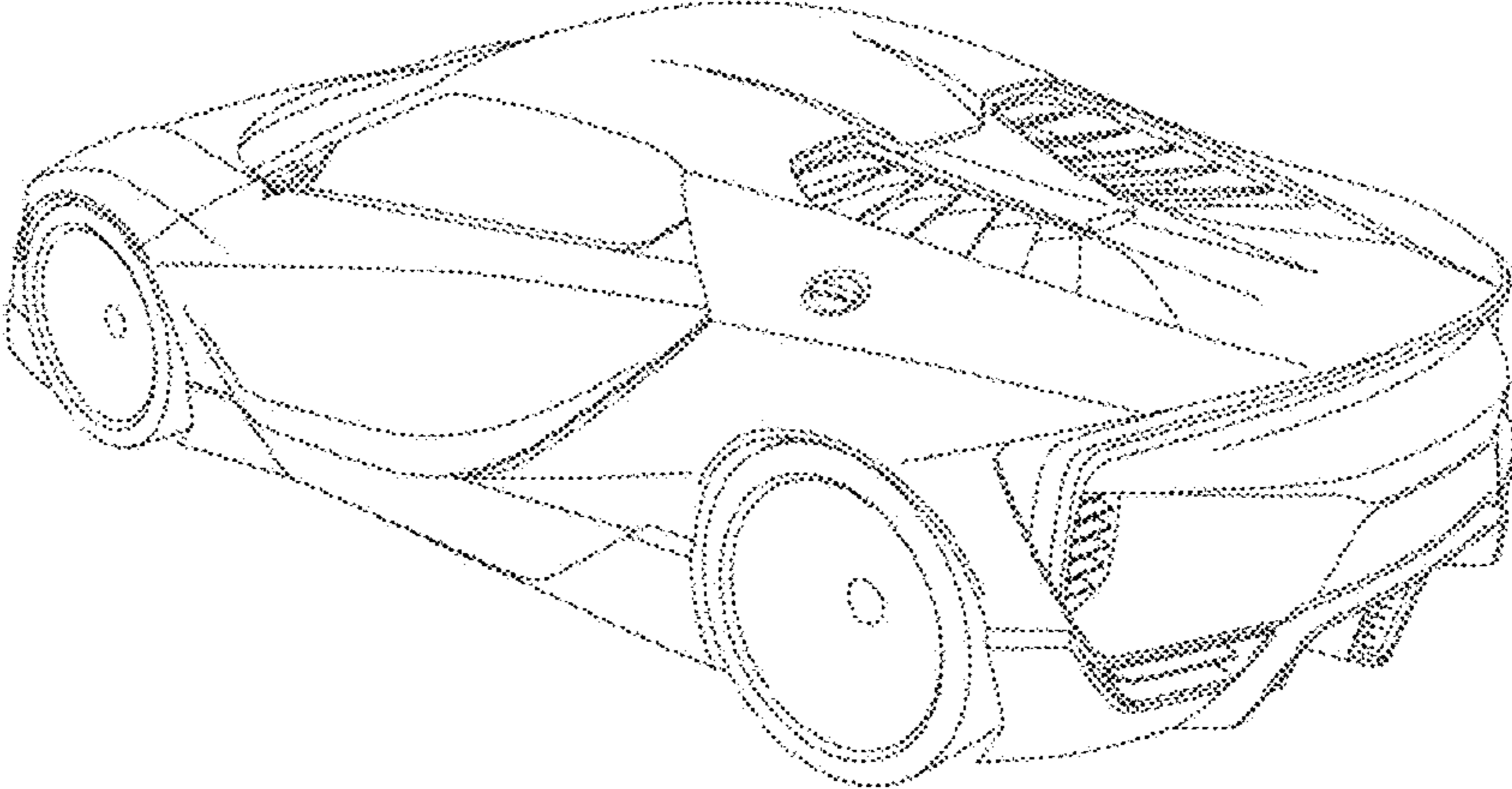

FIG.3

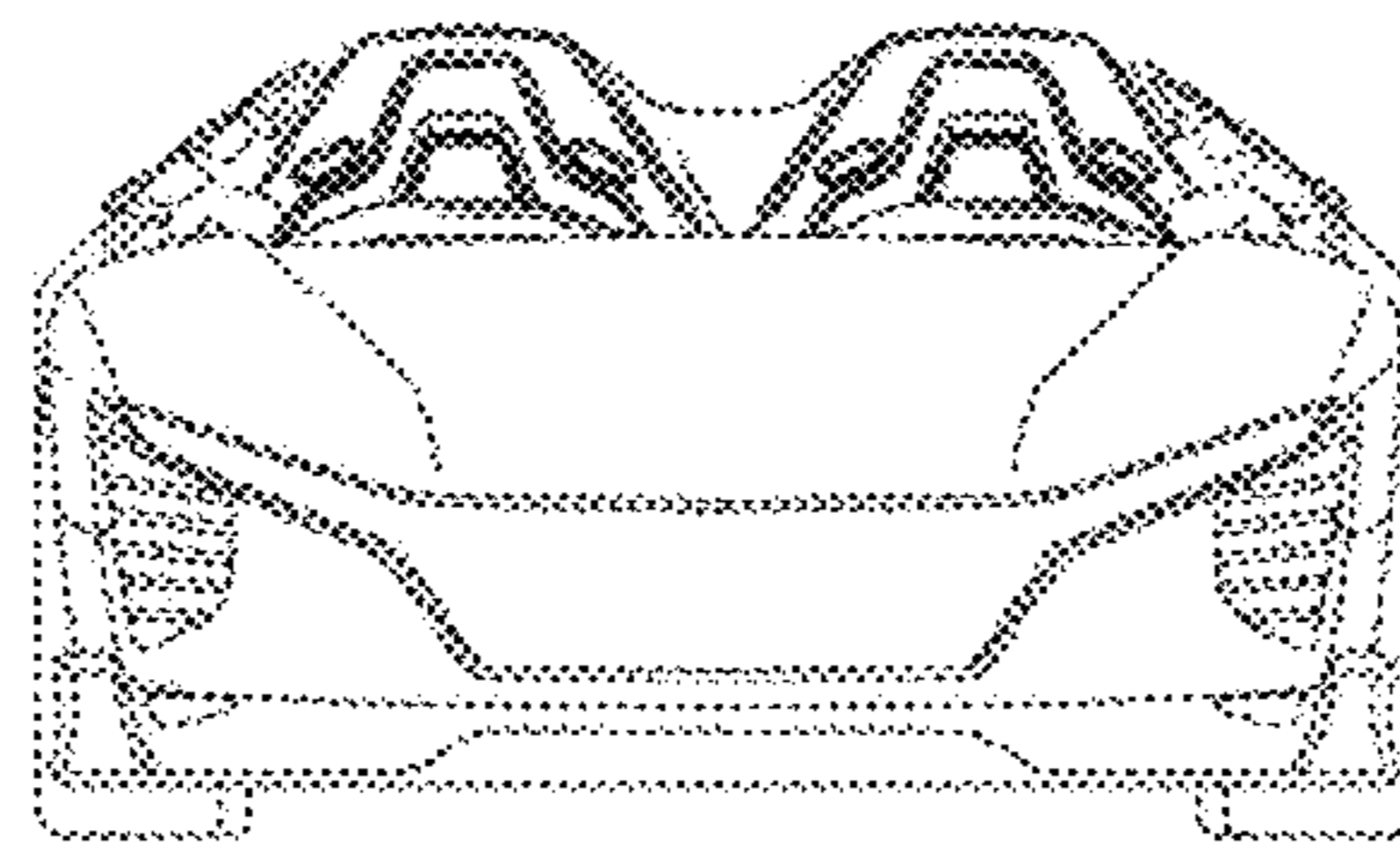

FIG.4

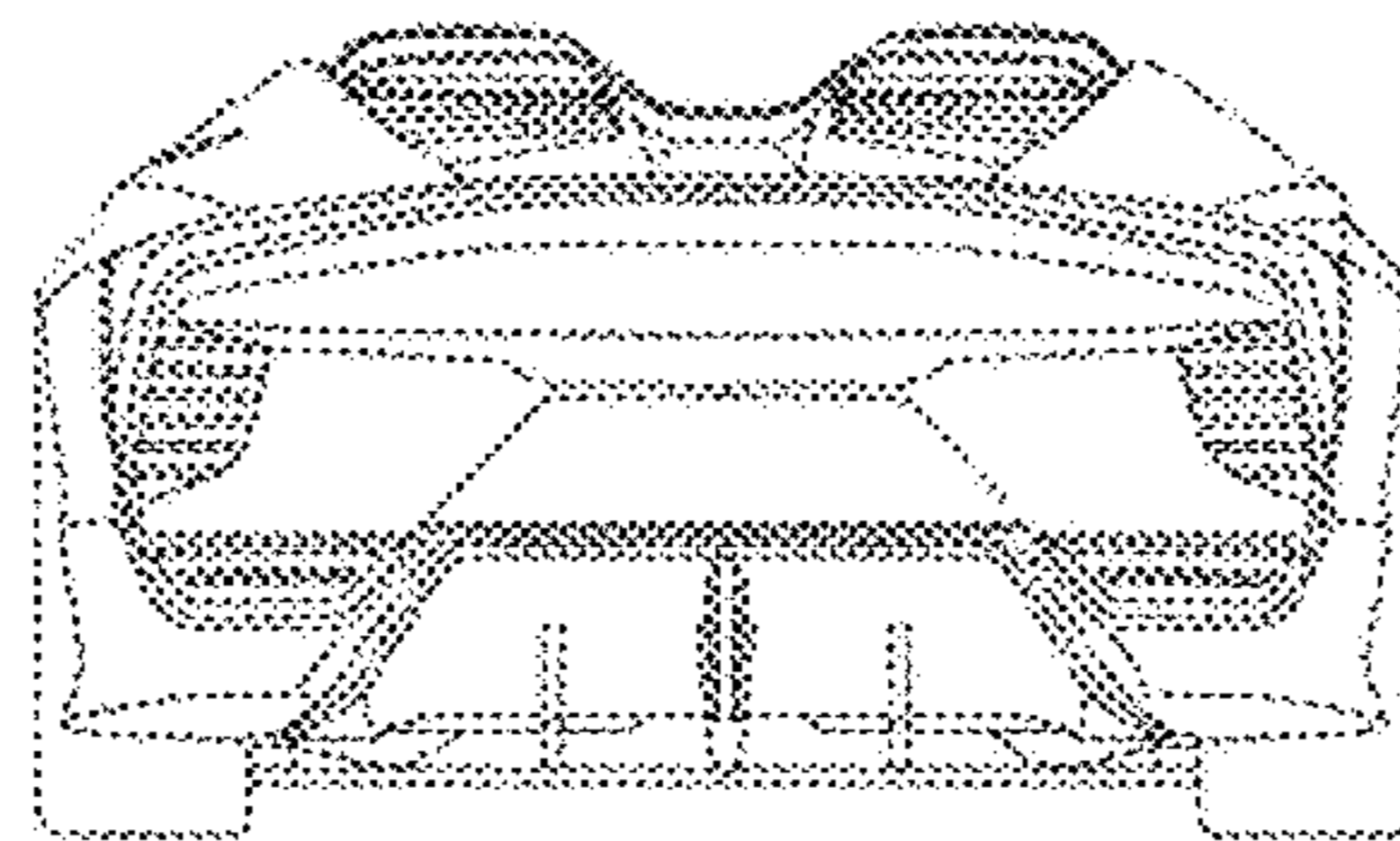

FIG.5

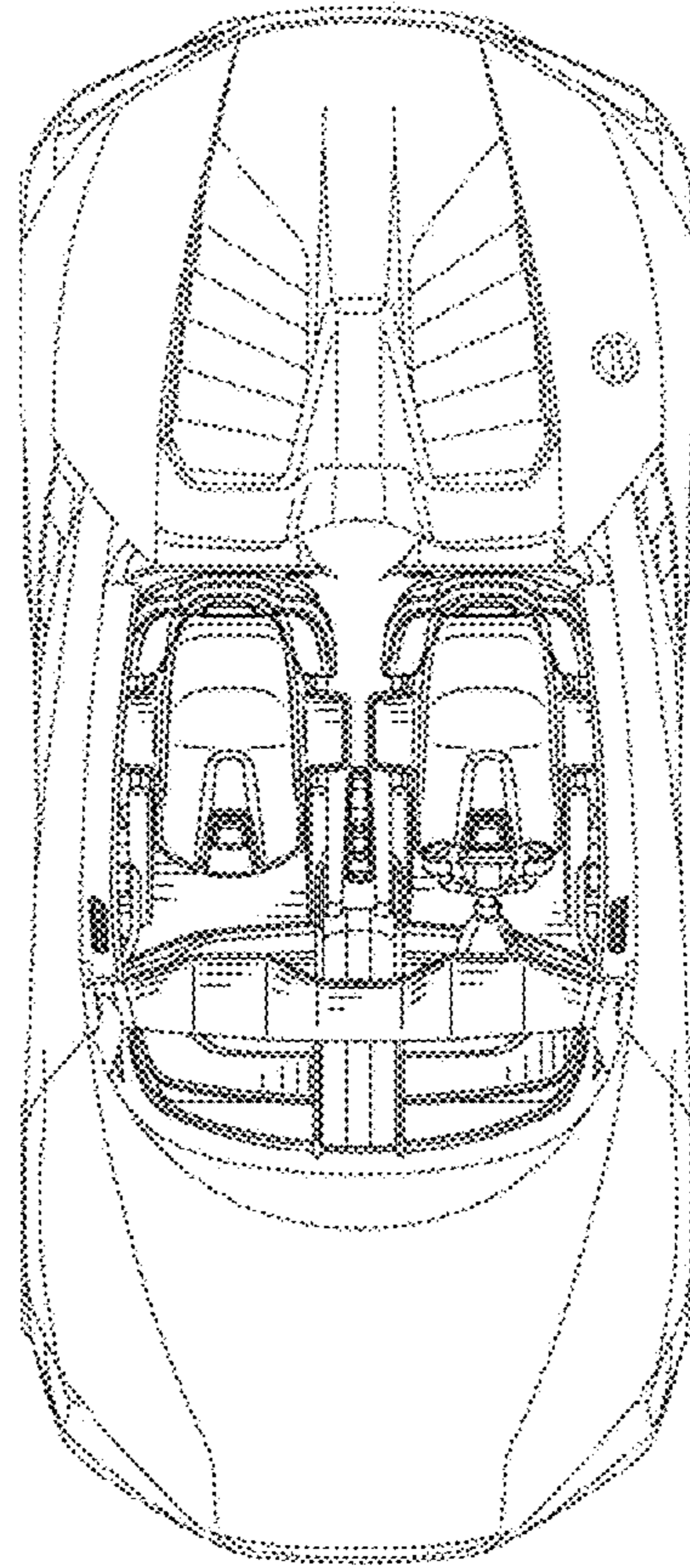

FIG.6

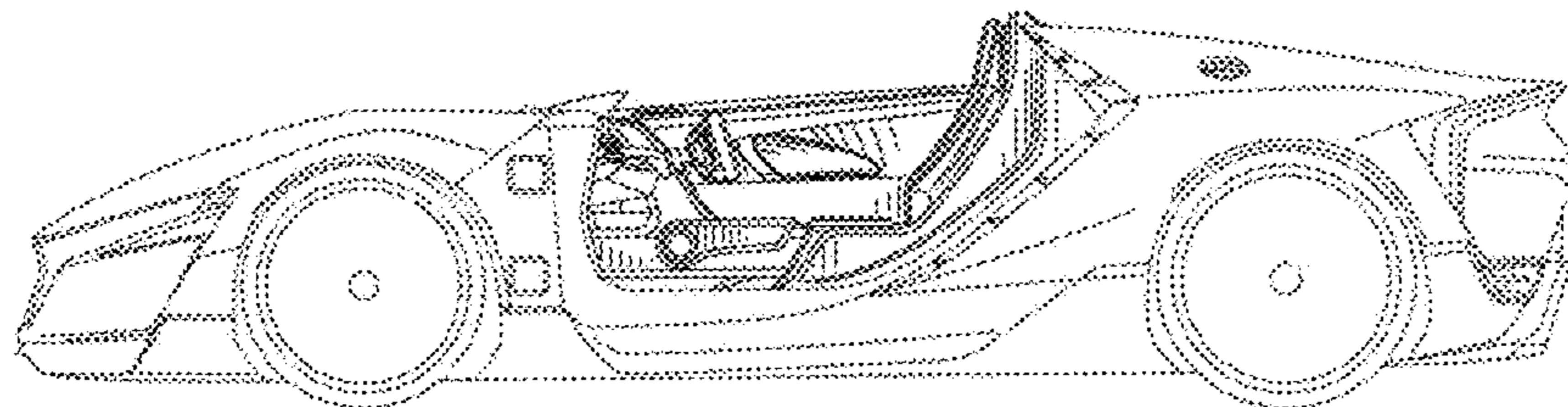

FIG.7

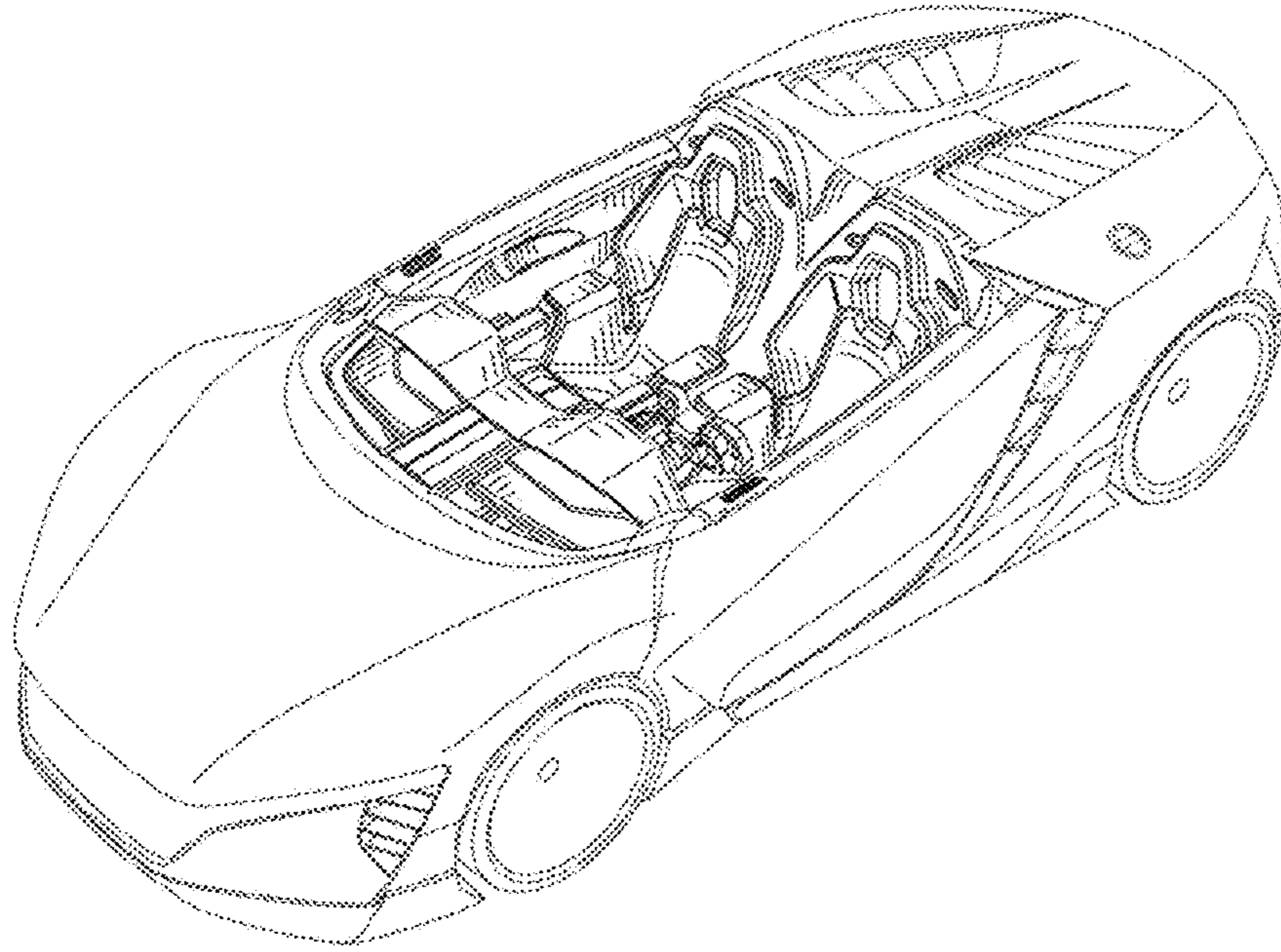

FIG.8

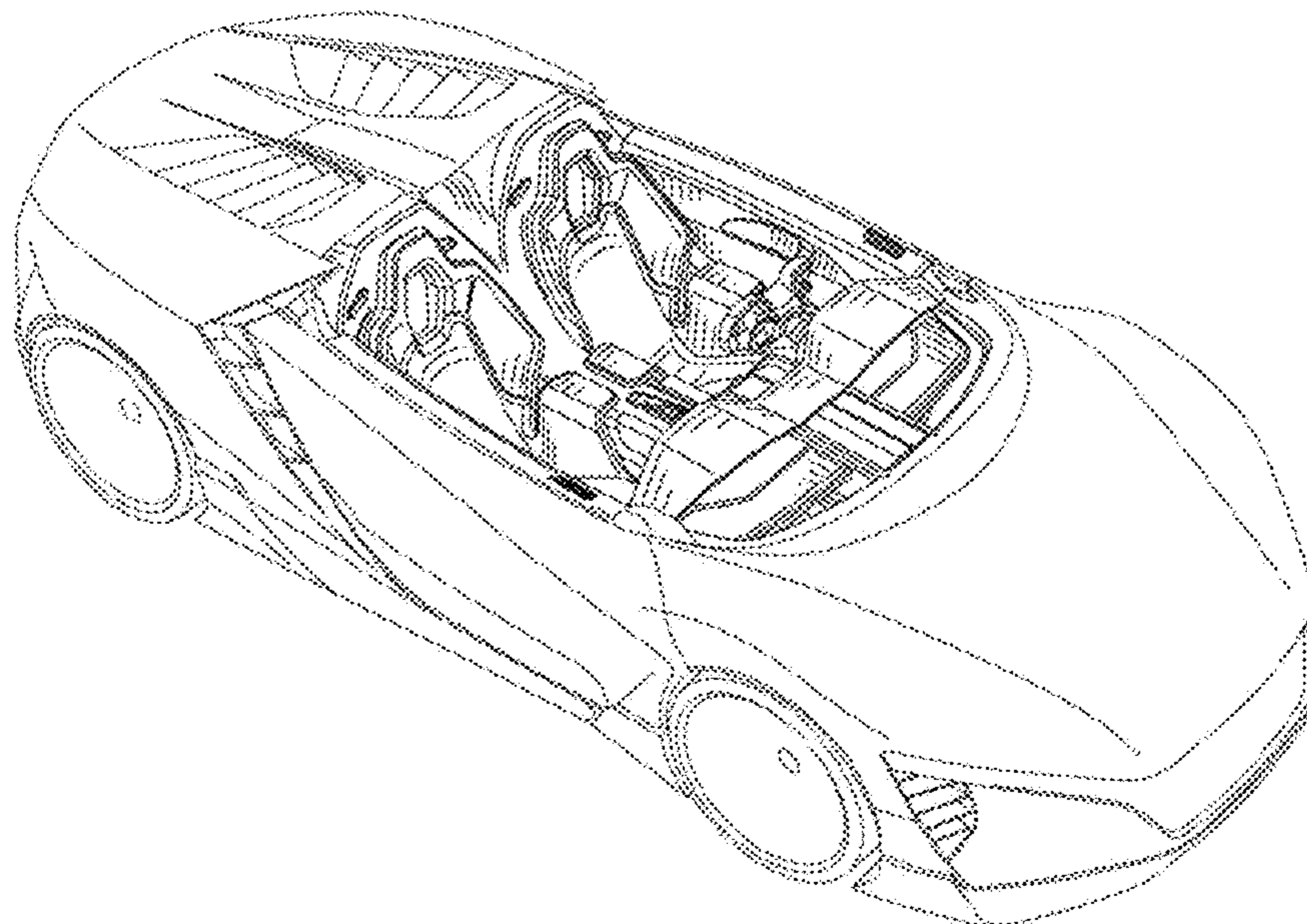

FIG.9

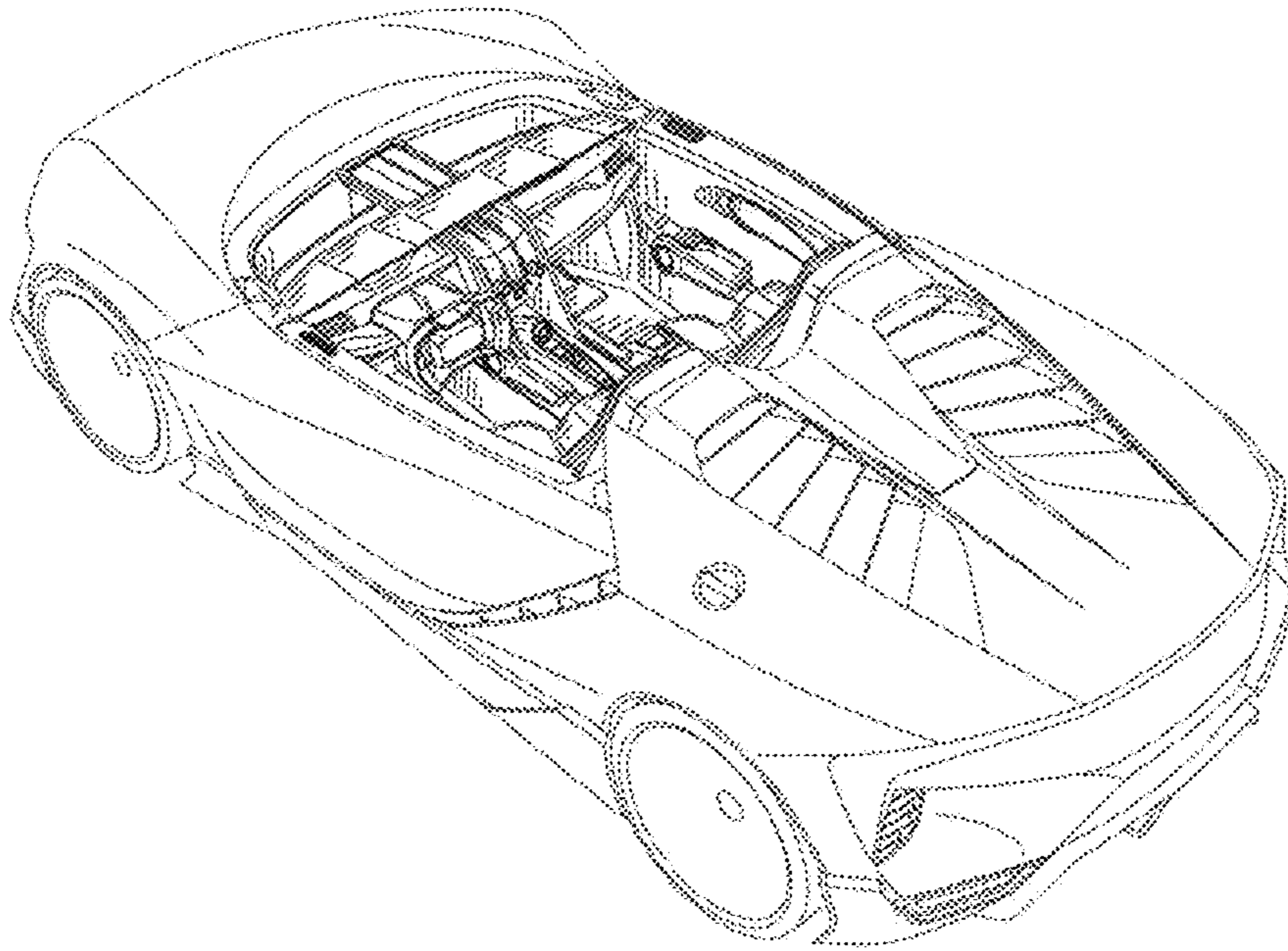

FIG.10

