



US00D848225S

(12) **United States Design Patent**  
**Zhang**

(10) **Patent No.:** **US D848,225 S**

(45) **Date of Patent:** **\*\* May 14, 2019**

(54) **INFLATABLE COASTER**

(71) Applicant: **Bo Zhang**, Guangdong (CN)

(72) Inventor: **Bo Zhang**, Guangdong (CN)

(73) Assignee: **SHENZHEN FENGBORUI TRADING CO., LTD**, Shenzhen (CN)

(\*\*) Term: **15 Years**

(21) Appl. No.: **29/614,880**

(22) Filed: **Aug. 24, 2017**

(51) **LOC (11) Cl.** ..... **07-06**

(52) **U.S. Cl.**  
USPC ..... **D7/625; D7/619.2**

(58) **Field of Classification Search**  
USPC ..... D7/619.1-625, 604, 606; D21/440, 597, D21/599, 808  
CPC ..... E04H 4/14; A47G 23/0216; A47G 23/02; A47G 23/03; A47G 23/06; A47G 23/23; A47G 23/032; A47G 23/0608; A47G 23/0225; A47G 2200/02; A47G 19/2283; A47G 21/16; A45C 2200/20; A45F 5/02; A47K 1/08; B65D 25/00; B65D 25/04; B60N 3/103

See application file for complete search history.

(56) **References Cited**

**U.S. PATENT DOCUMENTS**

D227,138 S \* 6/1973 Snyder ..... D11/158  
4,571,194 A \* 2/1986 Kiss ..... A47G 23/0216  
441/1

D302,718 S \* 8/1989 Wolfe ..... D21/620  
D783,370 S \* 4/2017 Su ..... D21/808  
D787,617 S \* 5/2017 Krepack ..... D21/808  
2012/0228175 A1 \* 9/2012 Ressel ..... E04H 4/14  
206/457

\* cited by examiner

*Primary Examiner* — Terry A Wallace

(57) **CLAIM**

The ornamental design for an inflatable coaster, as shown and described.

**DESCRIPTION**

FIG. 1 is a perspective view of an inflatable coaster showing my new design;  
FIG. 2 is a front elevational view thereof;  
FIG. 3 is a rear elevational view thereof;  
FIG. 4 is a left side elevational view thereof;  
FIG. 5 is a right side elevational view thereof;  
FIG. 6 is a top plan view thereof; and,  
FIG. 7 is a bottom plan view thereof.  
The broken lines shown in drawings are for the purpose of illustrating portions of the inflatable coaster and form no part of the claimed design.

**1 Claim, 7 Drawing Sheets**

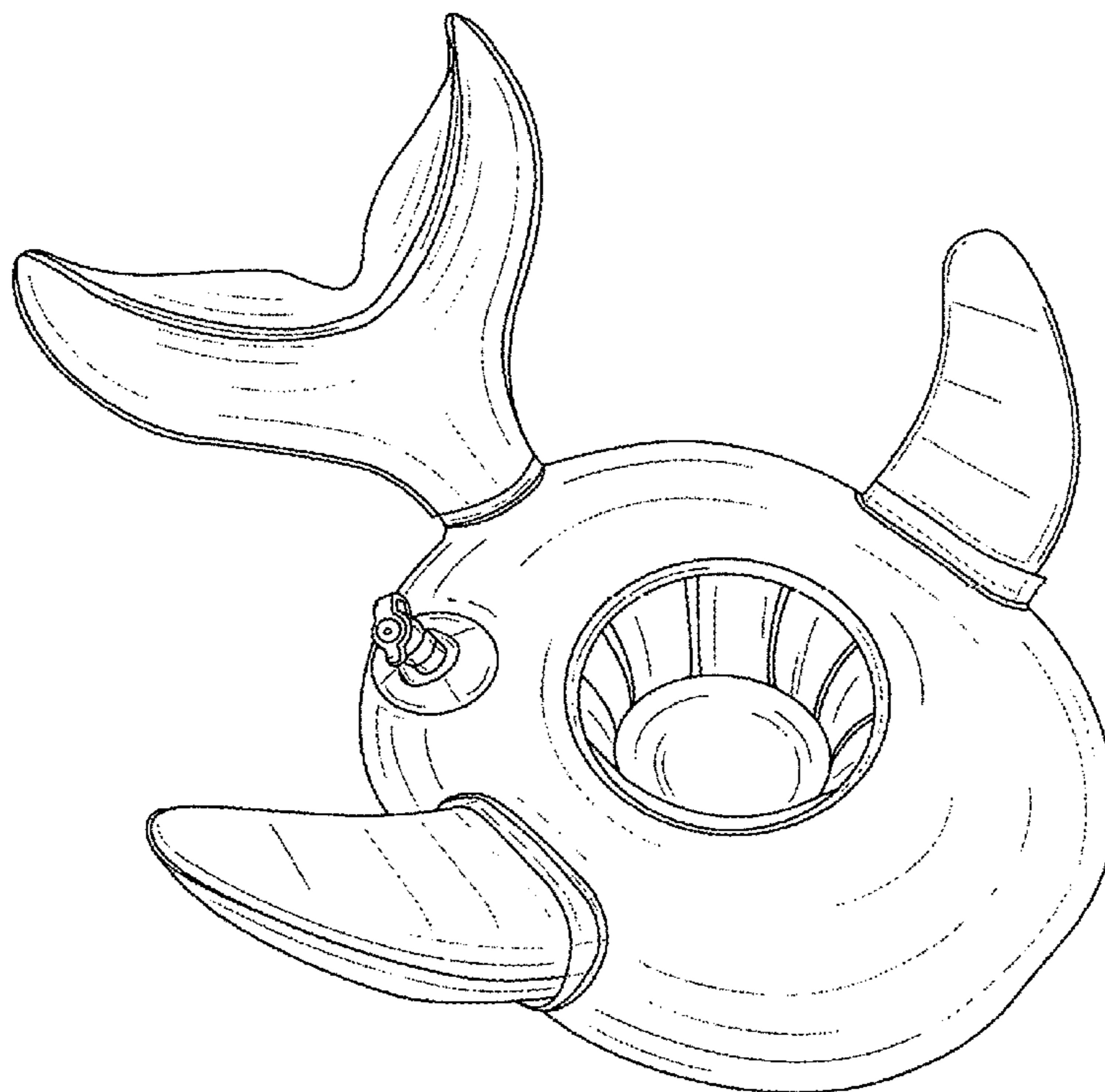

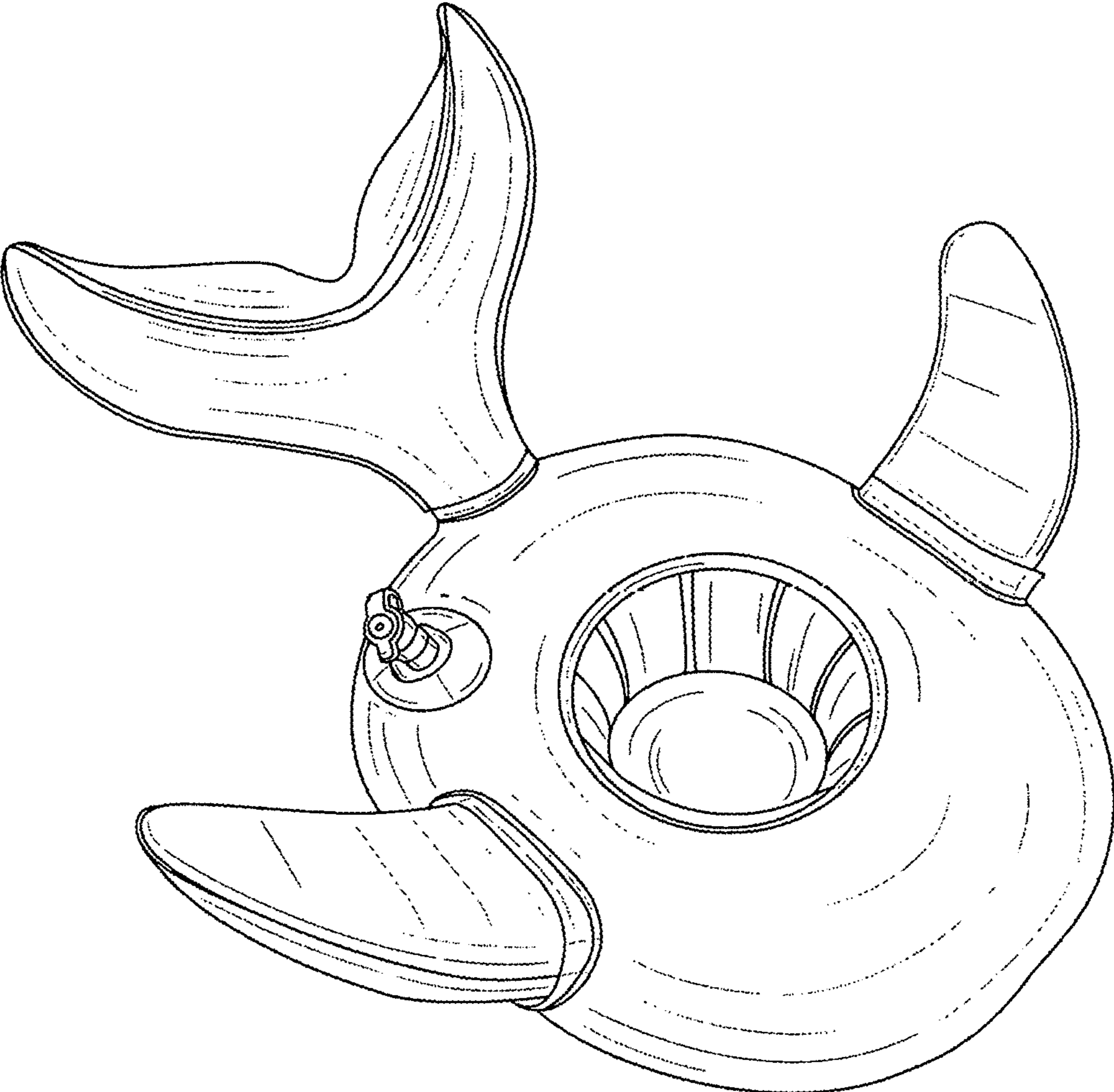

FIG.1

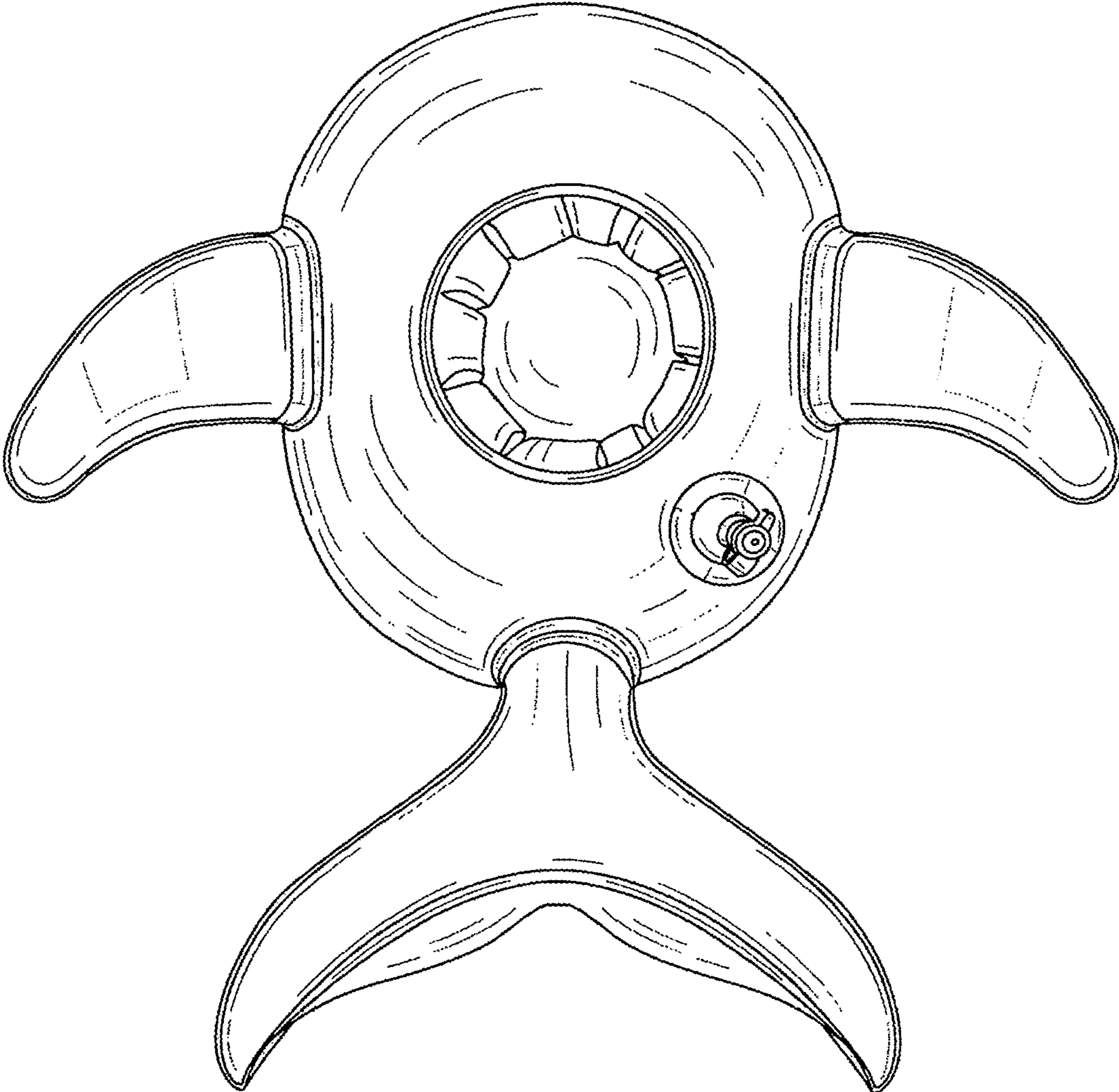

FIG.2

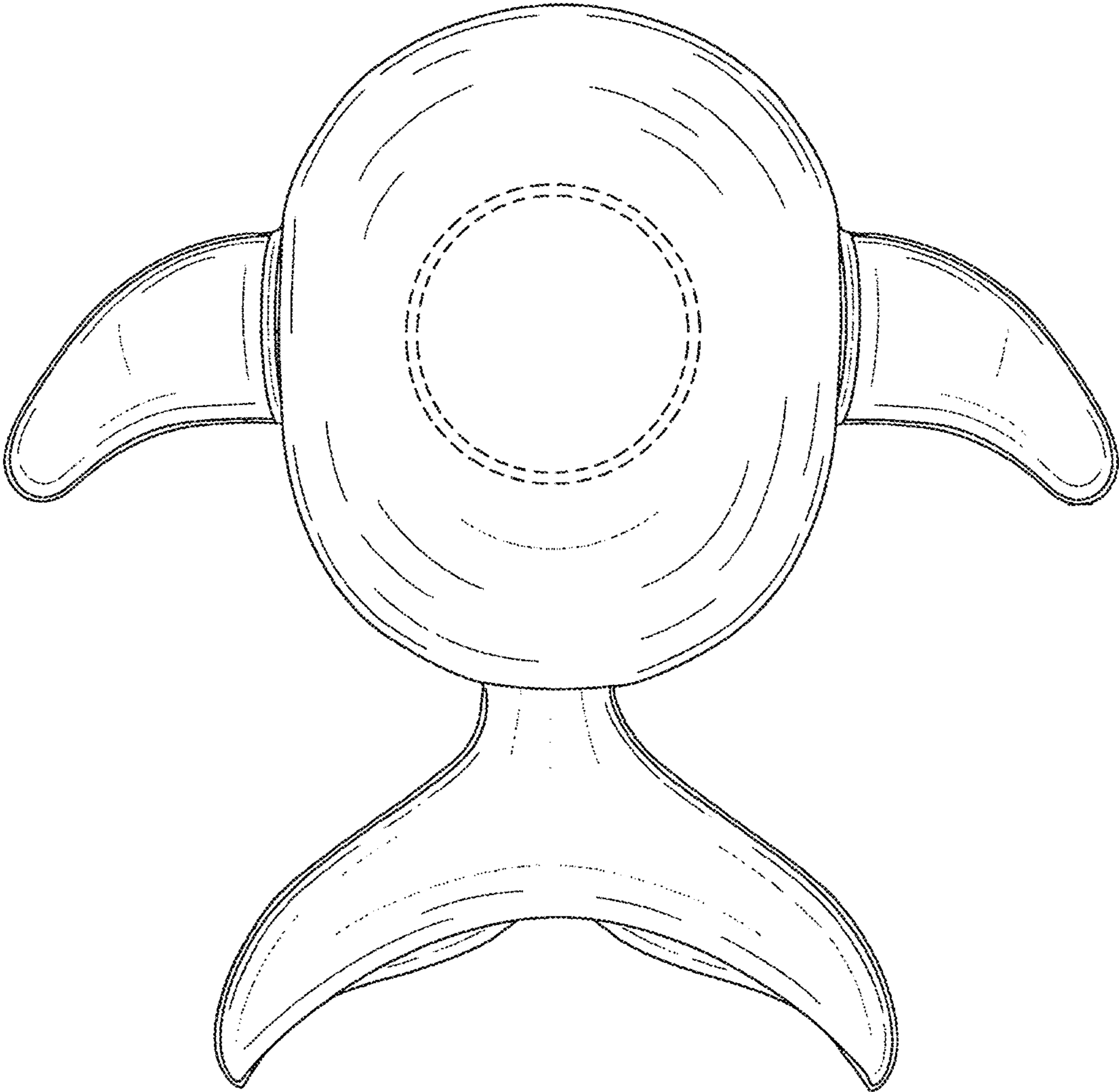

FIG.3

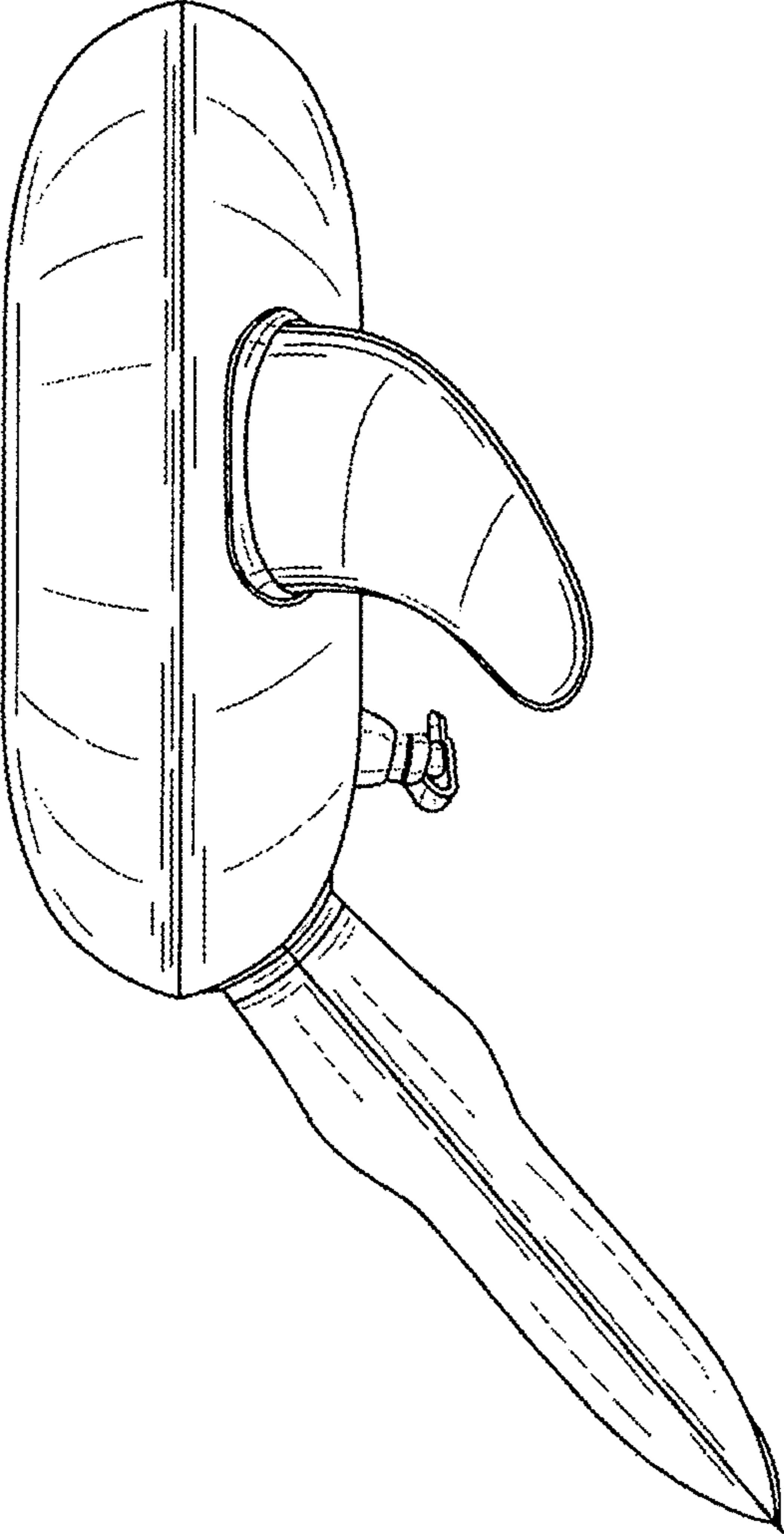

FIG.4

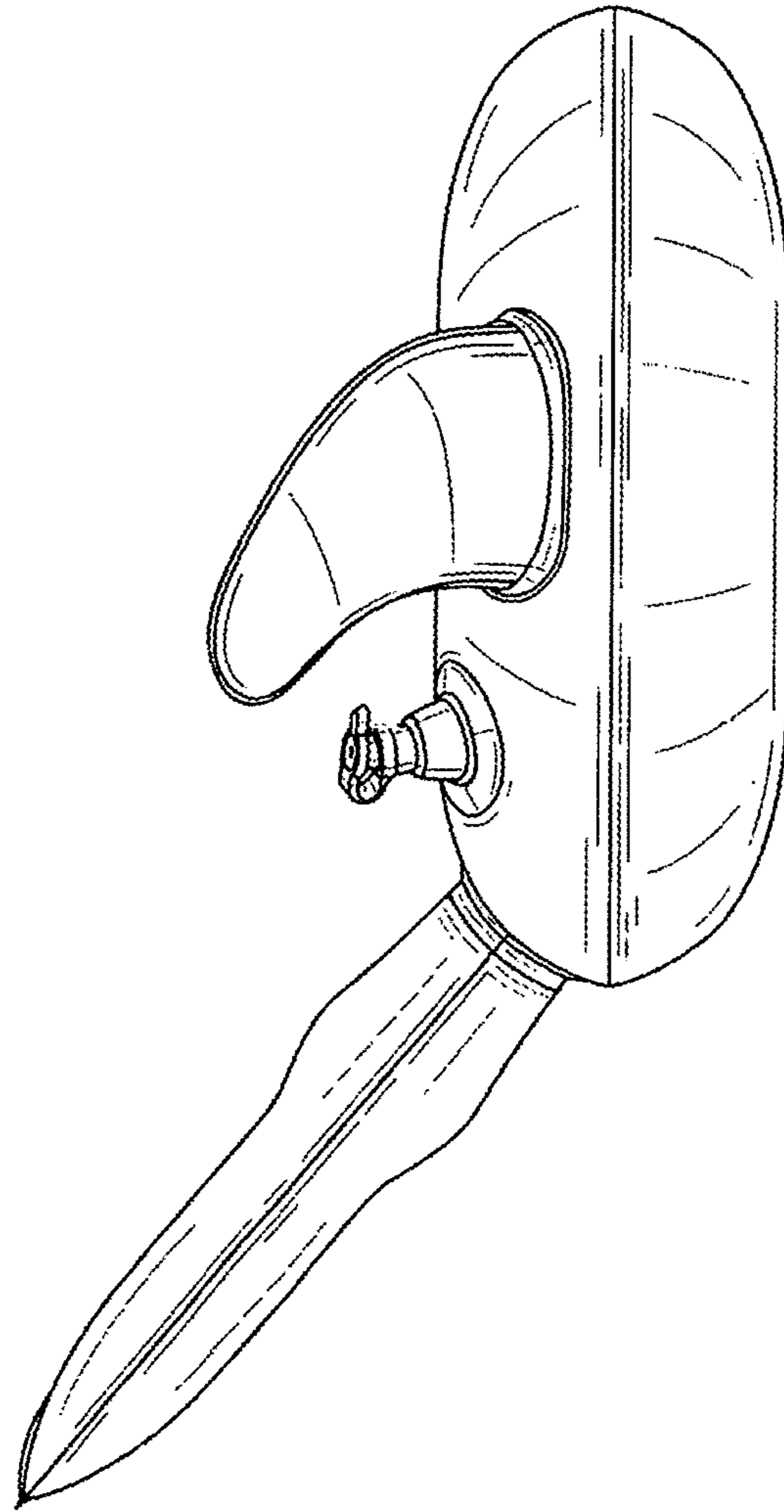

FIG.5

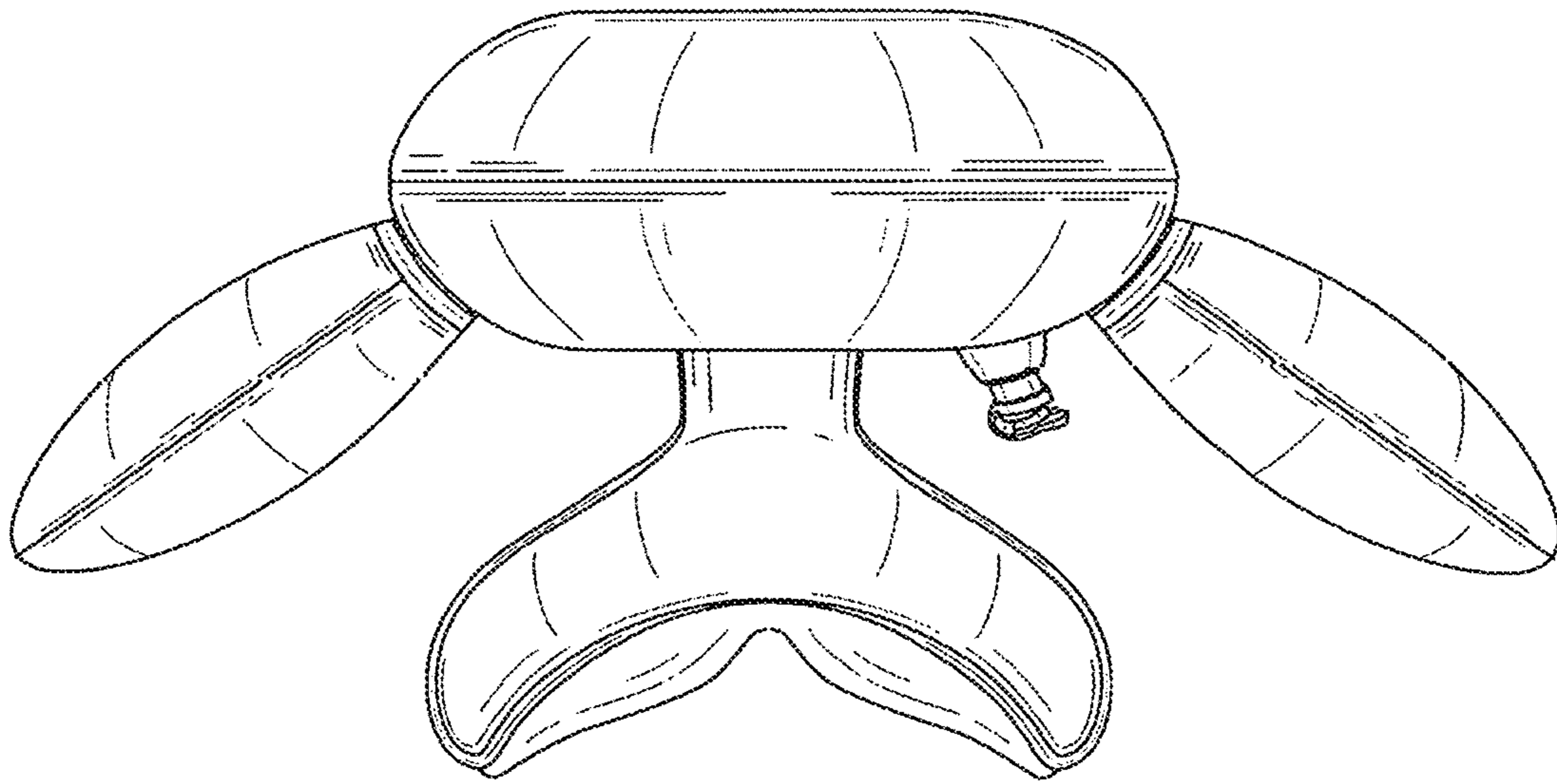

FIG.6

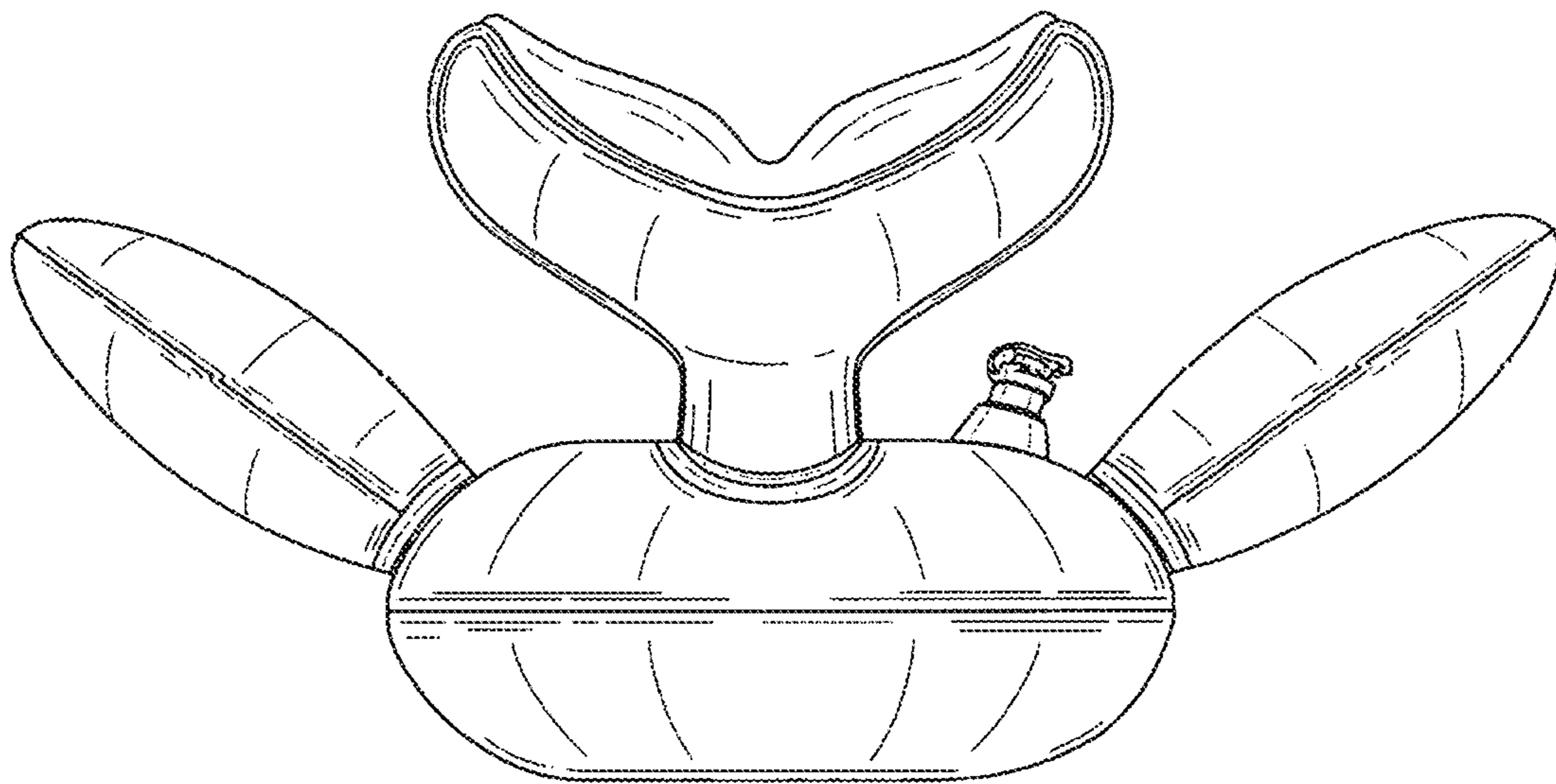

FIG. 7