



US00D848093S

(12) **United States Design Patent**
Buckley et al.

(10) **Patent No.:** **US D848,093 S**

(45) **Date of Patent:** **** May 7, 2019**

- (54) **HARD SURFACE CLEANING DEVICE**
- (71) Applicant: **Unger Marketing International, LLC**,
Bridgeport, CT (US)
- (72) Inventors: **James M. Buckley**, New Hartford, CT
(US); **Joseph K. Patterson**, Monroe,
CT (US); **Bryan Lee Roberts**,
Dormagen (DE)
- (73) Assignee: **UNGER MARKETING**
INTERNATIONAL, LLC, Bridgeport,
CT (US)
- (**) Term: **15 Years**

- D443,960 S * 6/2001 Shimko D32/18
- 6,497,525 B1 12/2002 Huang
- 6,536,379 B1 * 3/2003 Liu B08B 3/00
122/379
- 6,540,424 B1 4/2003 Hall et al.
- 6,551,001 B2 4/2003 Aberegg et al.
- 6,579,023 B2 6/2003 Kunkler et al.
- 6,612,768 B2 9/2003 Zorzo
- D481,183 S * 10/2003 Mangano D32/17
- 6,655,866 B1 12/2003 Morad et al.

(Continued)

FOREIGN PATENT DOCUMENTS

- CA 2730814 A1 8/2011
- CA 2893297 6/2014

OTHER PUBLICATIONS

HooverTwinTank_2011_Manual, 13 pages.

(Continued)

Primary Examiner — Ruth McInroy

(74) *Attorney, Agent, or Firm* — Cantor Colburn LLP

- (21) Appl. No.: **29/581,237**
- (22) Filed: **Oct. 17, 2016**
- (51) **LOC (11) Cl.** **15-05**
- (52) **U.S. Cl.**
USPC **D32/18**
- (58) **Field of Classification Search**
USPC D32/17-18, 21-22, 31, 34, 69-70, 72
CPC A47L 5/24; A47L 5/38; A47L 5/28; A47L
11/4044; A47L 11/34; A47L 7/0038;
A47L 9/325; A47L 9/02; A47L 1/08;
D01H 11/006; B60S 1/64; A46B 11/001;
A46B 11/002; B08B 3/026; B08B 3/028
See application file for complete search history.

(57) **CLAIM**

The ornamental design for a hard surface cleaning device, as shown and described.

DESCRIPTION

FIG. 1 is a front, top perspective view of a hard surface cleaning device showing our new design;
 FIG. 2 is a rear, bottom perspective view thereof;
 FIG. 3 is a left side view thereof;
 FIG. 4 is a right side view thereof;
 FIG. 5 is a rear view thereof;
 FIG. 6 is a front view thereof;
 FIG. 7 is a top view thereof; and,
 FIG. 8 is a bottom view thereof.
 The details shown in broken lines form no part of the claimed design.

(56) **References Cited**
U.S. PATENT DOCUMENTS

- 2,104,161 A 1/1938 Koukal
- 4,776,716 A 10/1988 Huang
- 4,863,299 A 9/1989 Osberghaus et al.
- 5,271,682 A 12/1993 Realdon
- 5,735,620 A 4/1998 Ford
- 5,888,006 A 3/1999 Ping et al.
- 6,031,969 A * 2/2000 Burr A47L 1/08
15/320
- 6,142,750 A 11/2000 Benecke

1 Claim, 8 Drawing Sheets

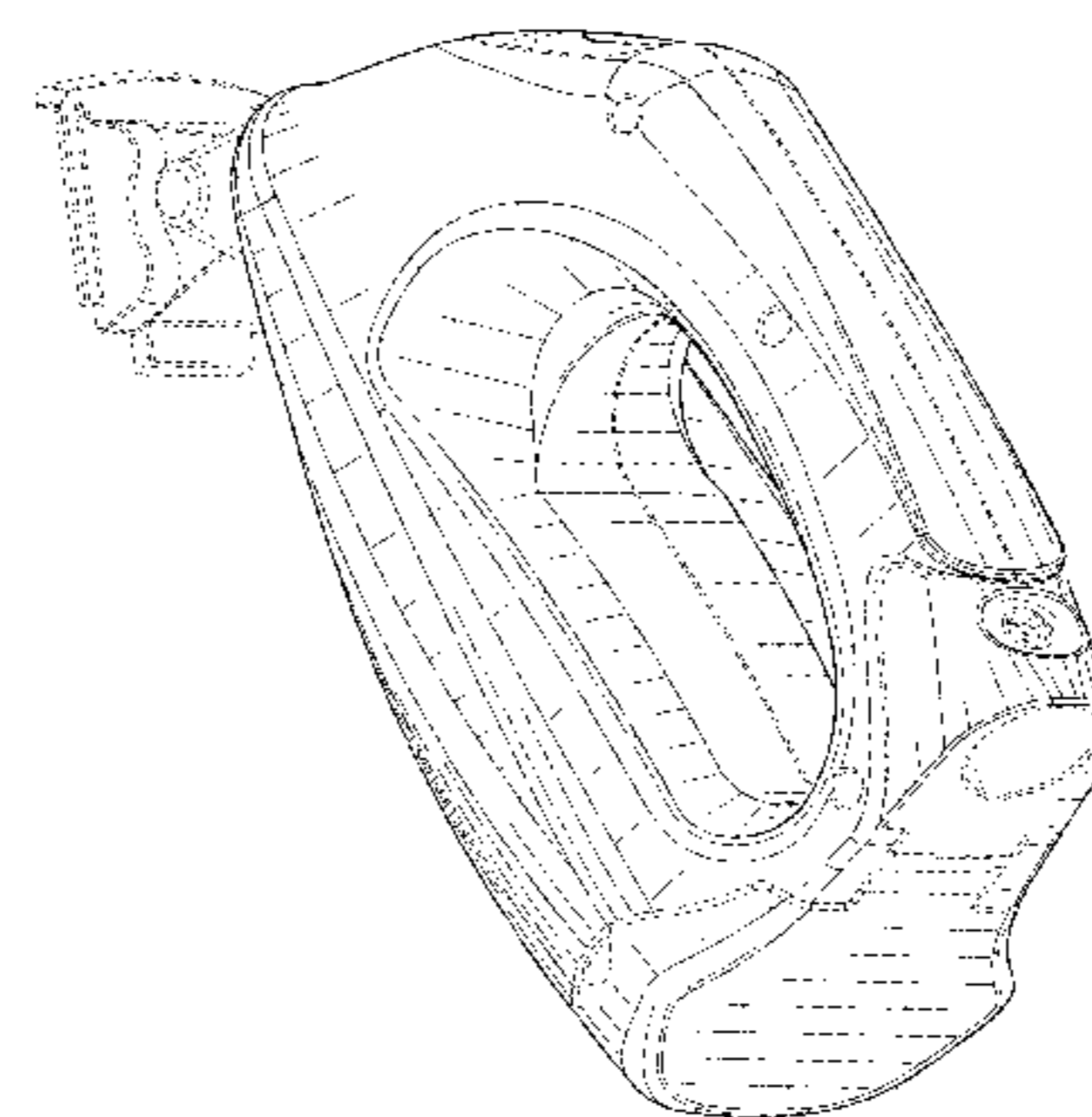
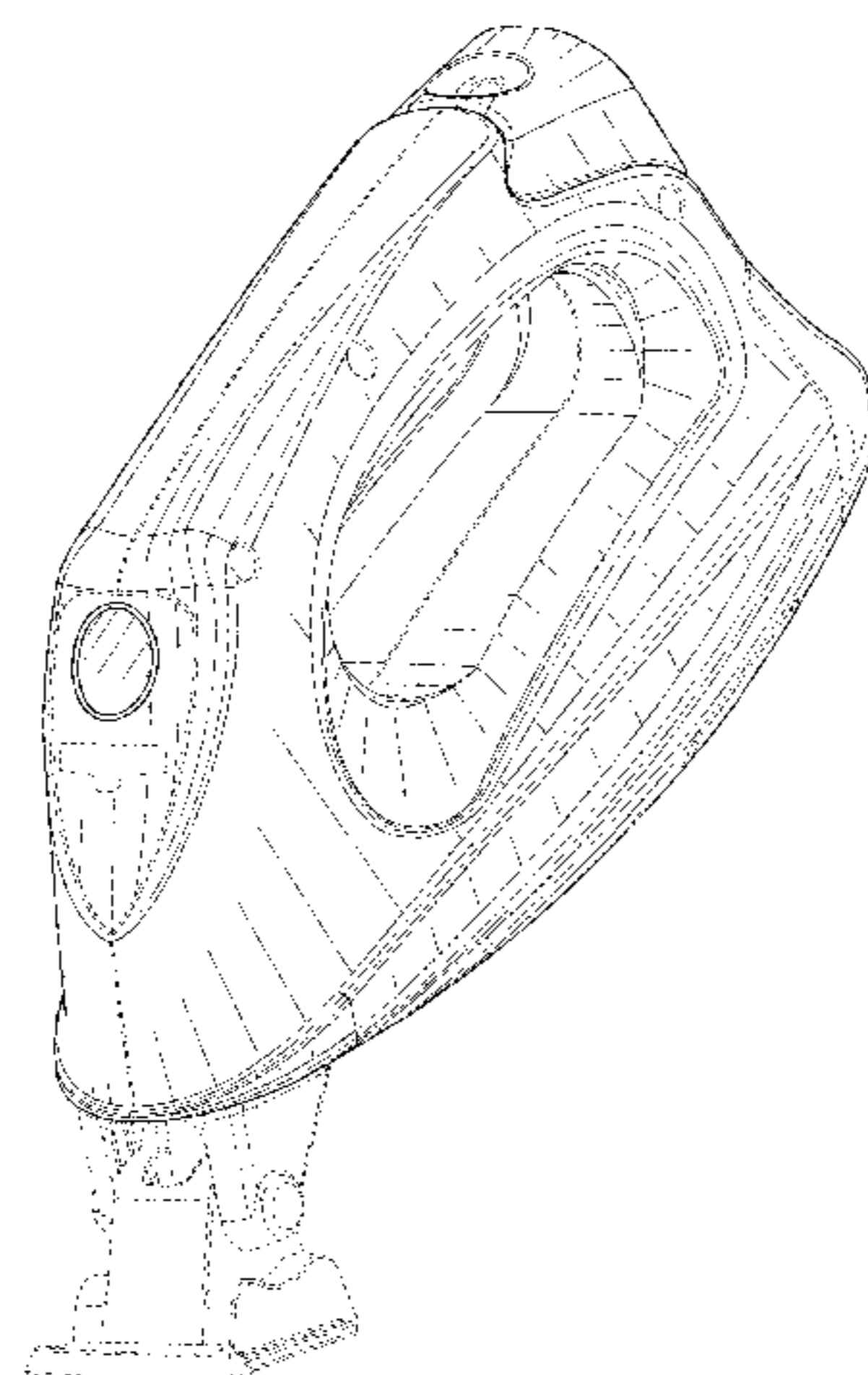

(56)

References Cited

U.S. PATENT DOCUMENTS

6,659,670 B1 12/2003 Blouse
 6,663,306 B2 12/2003 Policicchio et al.
 6,669,391 B2 12/2003 Policicchio et al.
 D485,652 S * 1/2004 Erlich D32/1
 6,722,806 B2 4/2004 Kunkler et al.
 6,726,388 B1 4/2004 Monahan
 6,854,911 B2 2/2005 Policicchio et al.
 6,854,912 B2 2/2005 Dyer et al.
 6,893,180 B2 5/2005 Hall et al.
 6,899,485 B2 5/2005 Hall et al.
 D507,852 S * 7/2005 Cheng D32/18
 6,953,299 B2 10/2005 Wang et al.
 6,960,042 B1 11/2005 Hsiao
 6,964,535 B2 11/2005 Bell et al.
 6,968,593 B1 * 11/2005 Lenkiewicz A47L 5/26
 15/320
 6,981,533 B2 1/2006 Zorzo
 6,986,618 B2 1/2006 Hall et al.
 6,986,619 B2 1/2006 Hall et al.
 7,004,658 B2 2/2006 Hall et al.
 D518,253 S * 3/2006 Erlich D32/18
 D522,191 S * 5/2006 Erlich D32/18
 7,048,458 B2 5/2006 Hall et al.
 7,048,804 B2 5/2006 Kisela et al.
 7,056,050 B2 6/2006 Sacks
 7,159,275 B2 1/2007 Chang
 7,160,044 B2 1/2007 Dyer et al.
 7,163,349 B2 1/2007 Policicchio et al.
 7,172,099 B2 2/2007 Hofte et al.
 7,191,486 B1 3/2007 Michelson et al.
 7,431,524 B2 10/2008 Sacks
 7,530,136 B1 5/2009 Ball
 7,618,206 B2 11/2009 Sacks
 7,699,551 B2 4/2010 Suda et al.
 7,708,485 B2 5/2010 Tanaka et al.
 7,722,273 B2 5/2010 Tanaka et al.
 7,850,384 B2 12/2010 Sacks
 D634,493 S * 3/2011 Breit D32/17
 8,069,520 B2 12/2011 Mattucci et al.
 8,079,770 B2 12/2011 Widmer et al.
 8,096,723 B2 1/2012 Bae
 8,109,685 B1 2/2012 Vito
 8,186,898 B2 5/2012 Bradbury et al.
 8,205,293 B2 6/2012 Rosenzweig et al.
 8,241,427 B1 8/2012 Crawford et al.
 8,267,607 B2 9/2012 Harris
 8,425,137 B1 4/2013 Sampaio

8,449,212 B2 5/2013 Crawford et al.
 8,544,146 B2 * 10/2013 Curien A47L 1/08
 15/245
 8,596,896 B2 12/2013 Kimura
 8,641,309 B2 2/2014 Perry et al.
 8,662,778 B2 3/2014 Crawford et al.
 8,667,637 B2 3/2014 Vrdoljak et al.
 D702,406 S * 4/2014 Mu D32/17
 D704,399 S * 5/2014 Crawley D32/17
 8,807,858 B2 8/2014 Fitzpatrick et al.
 8,834,053 B2 9/2014 Van Ledingham, Jr. et al.
 8,844,088 B2 9/2014 Garcia Castillo
 8,894,315 B2 11/2014 Dingert et al.
 8,926,210 B2 1/2015 Orubor
 8,927,480 B2 1/2015 Williams et al.
 9,021,654 B2 * 5/2015 Fischer A47L 1/05
 15/320
 9,044,132 B2 6/2015 Kaminer et al.
 D734,575 S * 7/2015 Zeng D32/17
 2003/0103795 A1 6/2003 Hollars et al.
 2003/0126710 A1 7/2003 Policicchio et al.
 2004/0146333 A1 7/2004 Fu
 2004/0223803 A1 11/2004 Fahy et al.
 2005/0031404 A1 2/2005 Tsai et al.
 2005/0089360 A1 4/2005 Garabedian, Jr. et al.
 2005/0191116 A1 9/2005 Flanery et al.
 2006/0039743 A1 2/2006 Mensink et al.
 2006/0110207 A1 5/2006 Augustinus Hofte et al.
 2006/0213017 A1 9/2006 Bele et al.
 2007/0140774 A1 6/2007 Dyer et al.
 2007/0231046 A1 10/2007 Whiffen et al.
 2008/0038045 A1 2/2008 Hofte et al.
 2008/0066242 A1 3/2008 Aiyar
 2008/0205972 A1 8/2008 LaFlamme et al.
 2011/0158740 A1 6/2011 Kandasamy et al.
 2012/0227763 A1 9/2012 Hayes et al.
 2013/0263396 A1 10/2013 Crawford et al.
 2013/0263398 A1 10/2013 Irwin et al.
 2014/0317868 A1 10/2014 Fitzpatrick et al.
 2015/0082570 A1 3/2015 Davidshofer et al.
 2015/0089757 A1 4/2015 Davidshofer et al.
 2015/0101140 A1 4/2015 Pierce

OTHER PUBLICATIONS

International Search Report and Written Opinion dated Feb. 25, 2016 for corresponding International Patent Application No. PCT/US2015/068212, 8 pages.

* cited by examiner

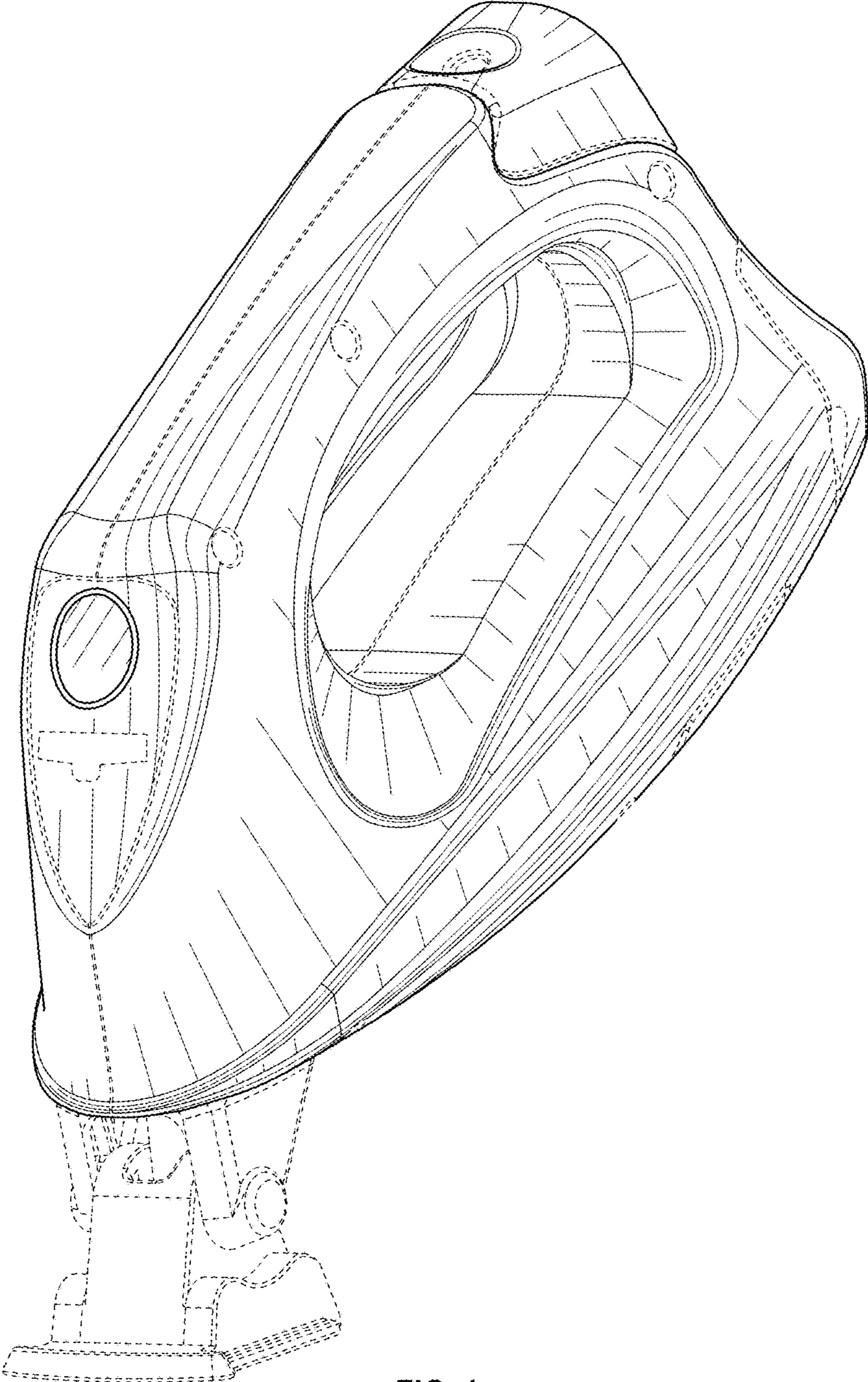

FIG. 1

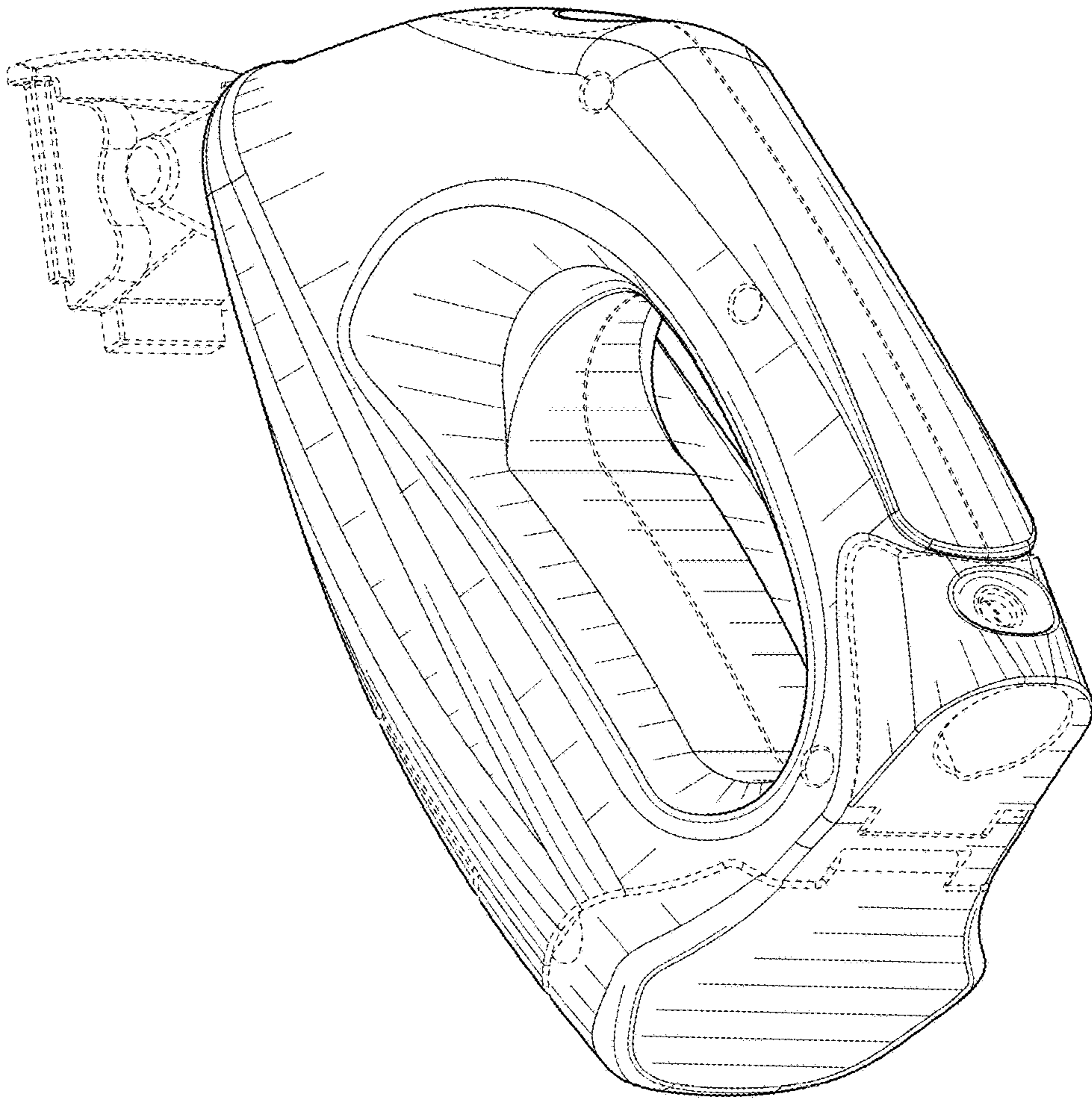

FIG. 2

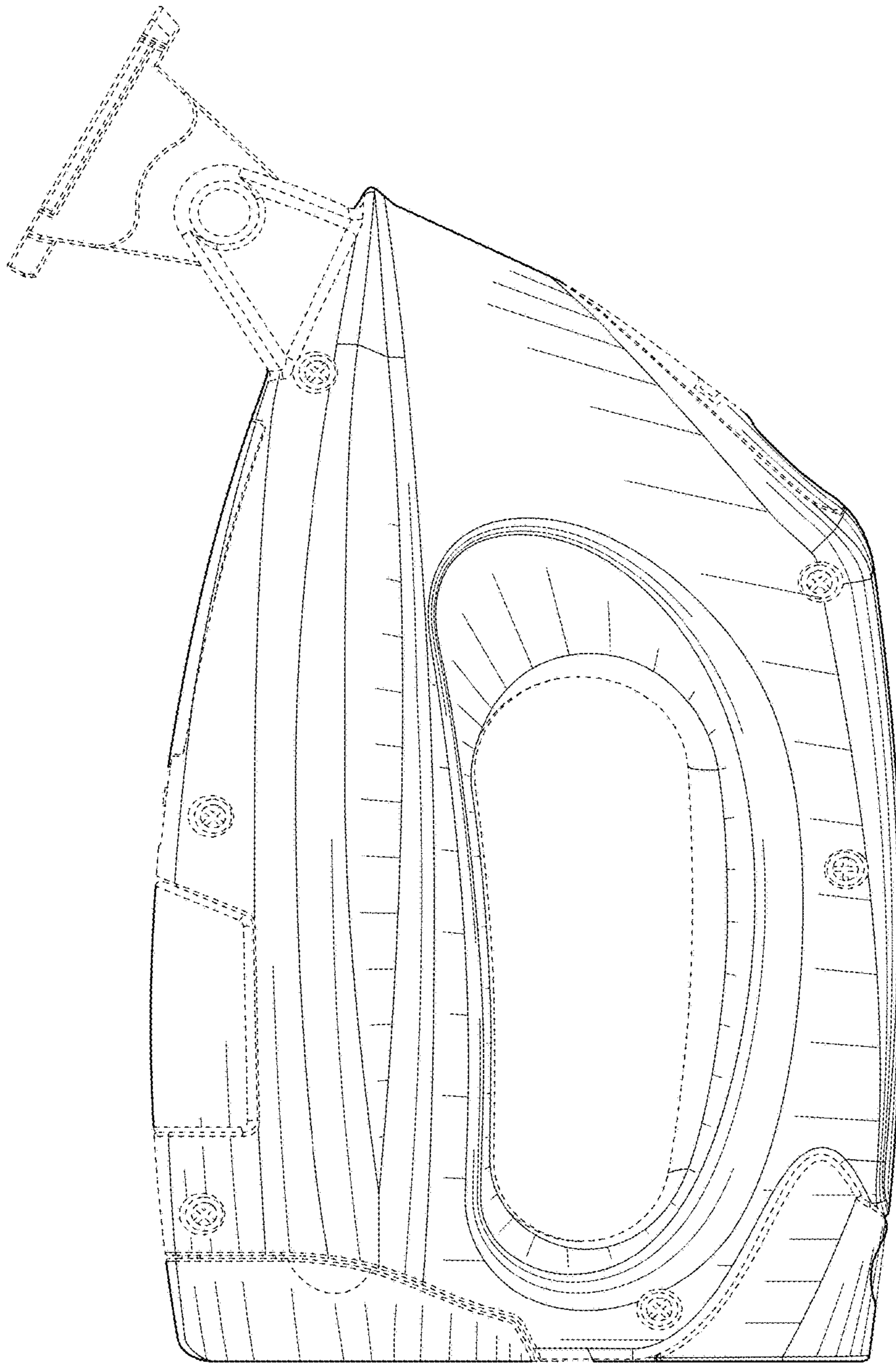

FIG. 3

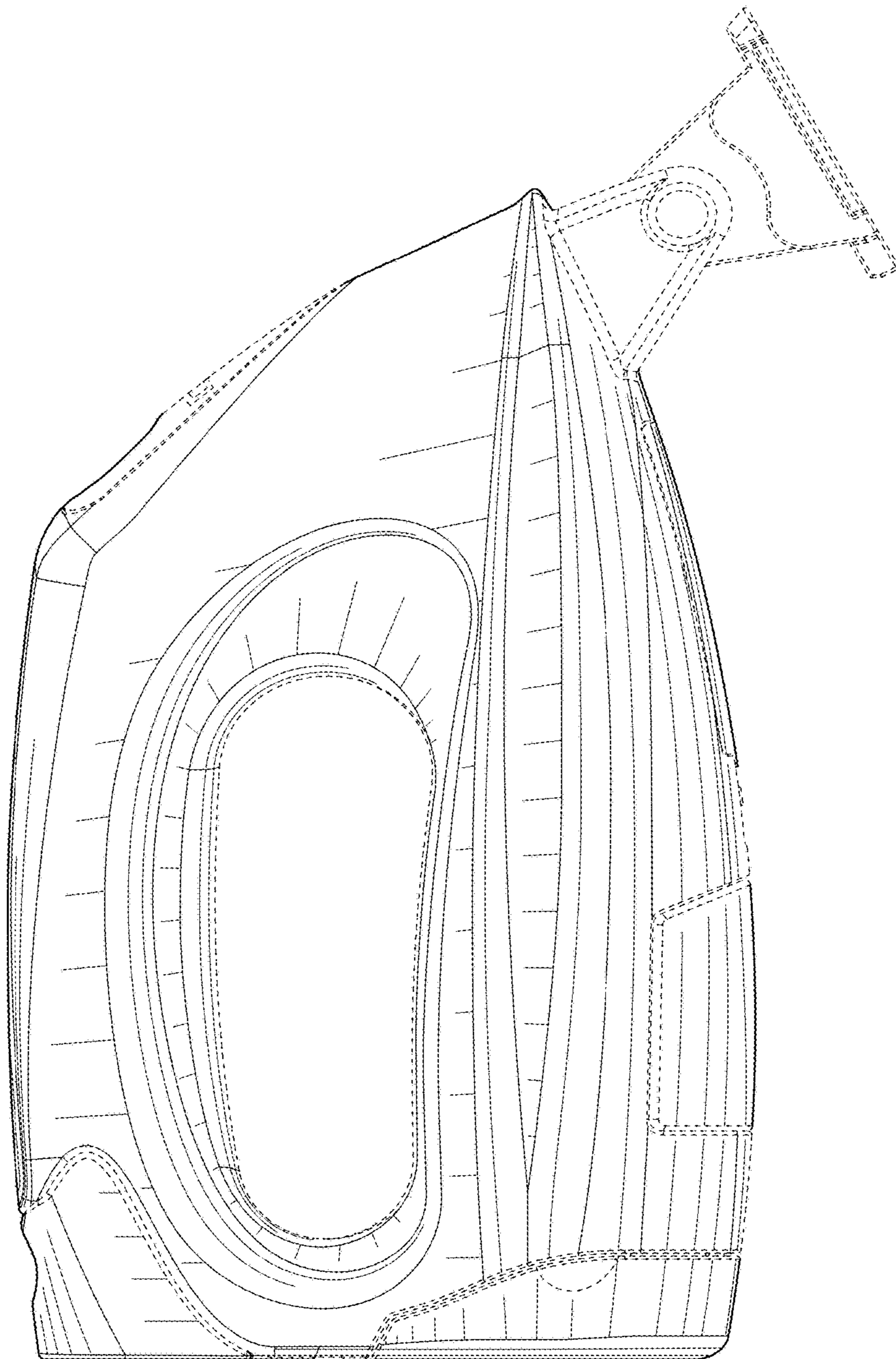

FIG. 4

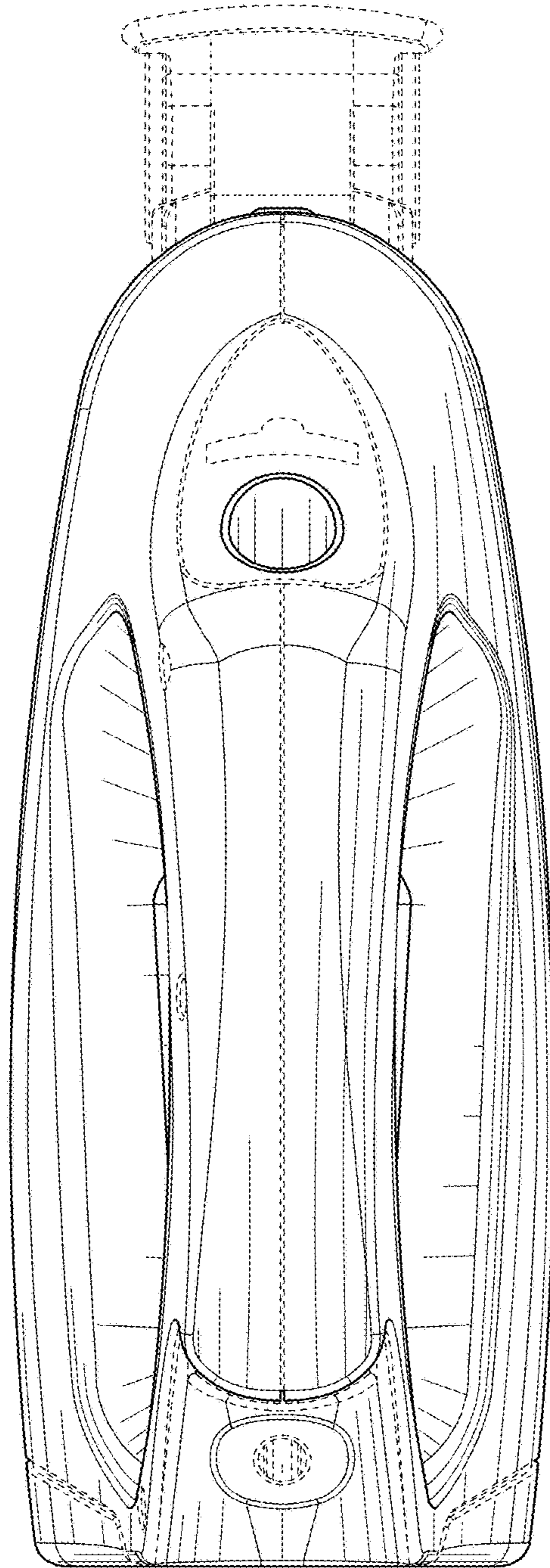

FIG. 5

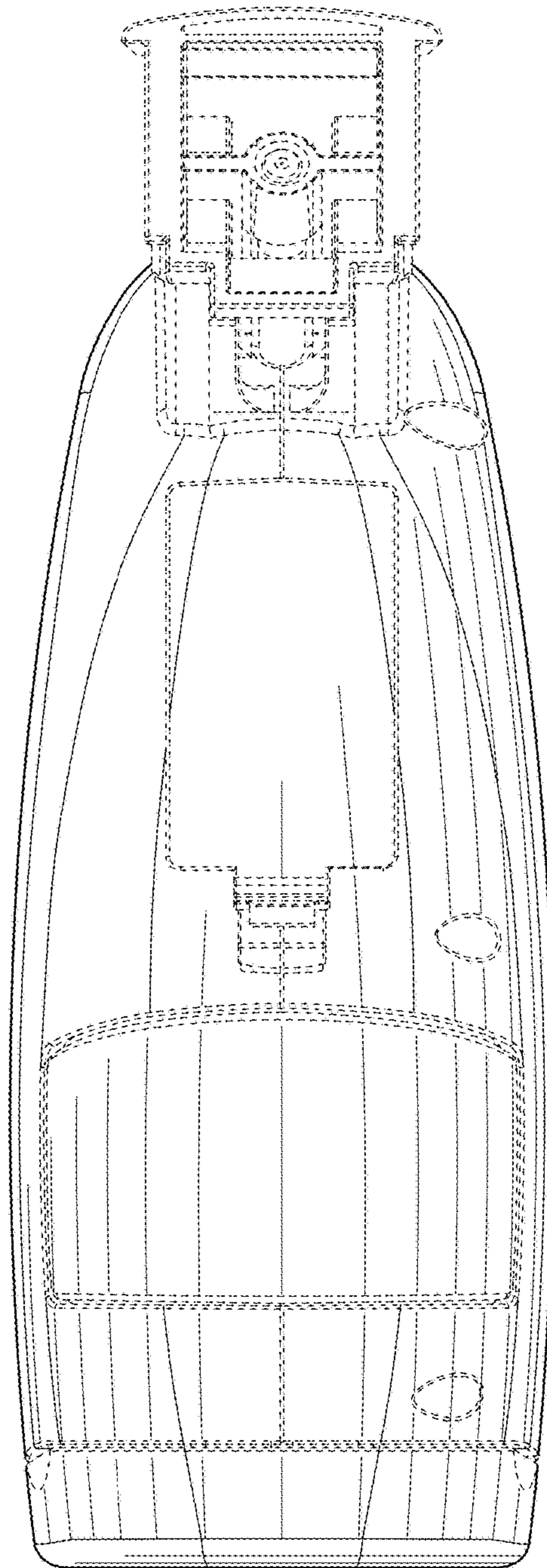

FIG. 6

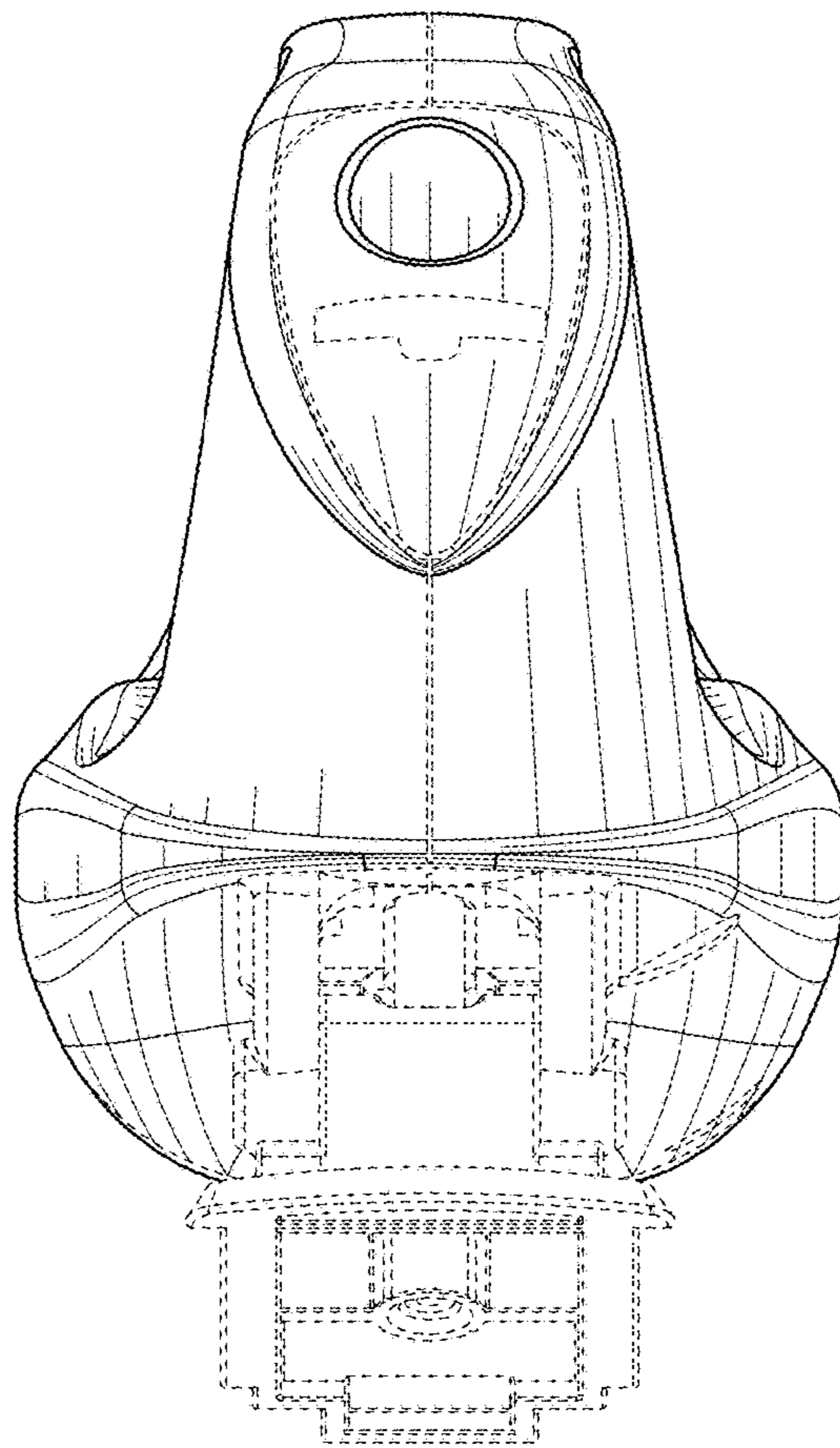

FIG. 7

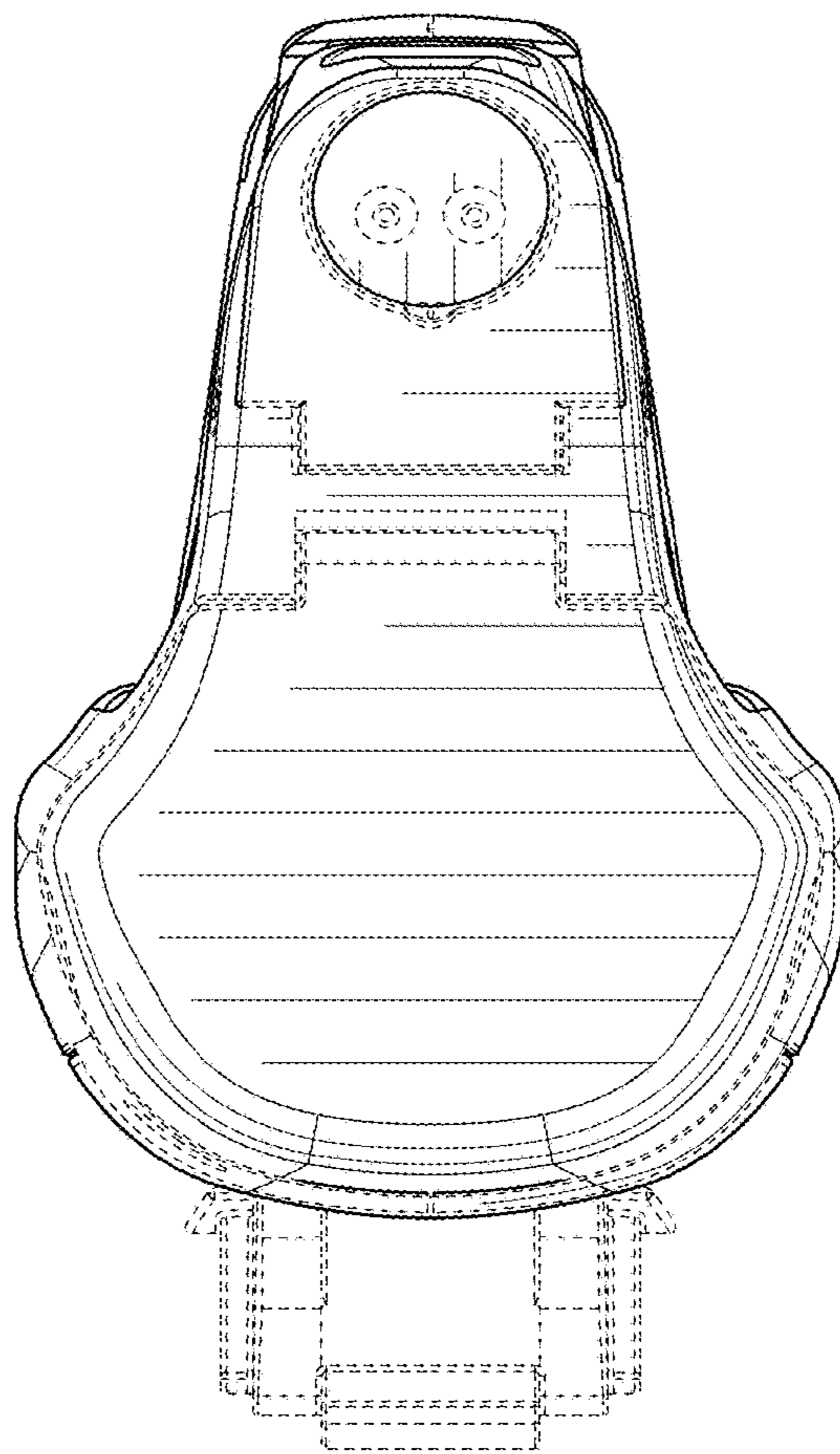

FIG. 8