



US00D848069S

(12) **United States Design Patent** (10) **Patent No.:** **US D848,069 S**
Micinilio (45) **Date of Patent:** **** *May 7, 2019**

(54) **SAFETY RAZOR**
(71) Applicant: **Edgewell Personal Care Brands, LLC.,** Chesterfield, MO (US)
(72) Inventor: **Gregg Micinilio,** Trumbull, CT (US)
(73) Assignee: **Edgewell Personal Care Brands, LLC.,** Chesterfield, MO (US)
(*) Notice: This patent is subject to a terminal disclaimer.
(**) Term: **15 Years**
(21) Appl. No.: **29/604,563**
(22) Filed: **May 18, 2017**
(51) **LOC (11) Cl.** **28-03**
(52) **U.S. Cl.**
USPC **D28/46**
(58) **Field of Classification Search**
USPC D28/46-48
CPC B26B 21/52-21/528; B26B 21/14-21/38;
B26B 21/08; B26B 21/00; B26B
21/40-21/60
See application file for complete search history.

D644,789 S * 9/2011 Lukan D28/46
D645,205 S * 9/2011 Lukan D28/48
D659,285 S * 5/2012 Lukan D28/46
D659,286 S * 5/2012 Lukan D28/46
D674,552 S * 1/2013 Barrow D28/48
D707,885 S * 6/2014 Cataudella D28/47
D730,579 S * 5/2015 Han D28/48
D749,264 S * 2/2016 Leatherman D28/46
D816,911 S * 5/2018 Zucker D28/47
2007/0062047 A1* 3/2007 Zhuk B26B 21/22
30/346.53

OTHER PUBLICATIONS

Sensitive Skin Razor for Men | Schick Hydro 5 Sense Sensitive, <http://www.schick.com/mens-razors/schick-hydro-5-sense-sensitive-razor>[Jun. 11, 2018 10:35:23 AM], reviewed as early as Feb. 2018, 6 pages.*

* cited by examiner

Primary Examiner — Jennifer Rivard

(57) **CLAIM**

I claim the ornamental design for the safety razor, as shown and described.

DESCRIPTION

FIG. 1 is an upper perspective view of a safety razor.
FIG. 2 is a lower perspective view thereof.
FIG. 3 is a rear view thereof.
FIG. 4 is a front view thereof.
FIG. 5 is a left side view of FIG. 3.
FIG. 6 is a right side view of FIG. 3.
FIG. 7 is a top view thereof; and,
FIG. 8 is a bottom view thereof.

1 Claim, 4 Drawing Sheets

(56) **References Cited**

U.S. PATENT DOCUMENTS

D491,311 S * 6/2004 Follo D28/48
7,200,942 B2* 4/2007 Richard B26B 21/225
30/526
D604,904 S * 11/2009 Watson D28/47
D615,247 S * 5/2010 Lukan D28/48
D617,946 S 6/2010 Lukan et al.
D617,947 S 6/2010 Lukan et al.

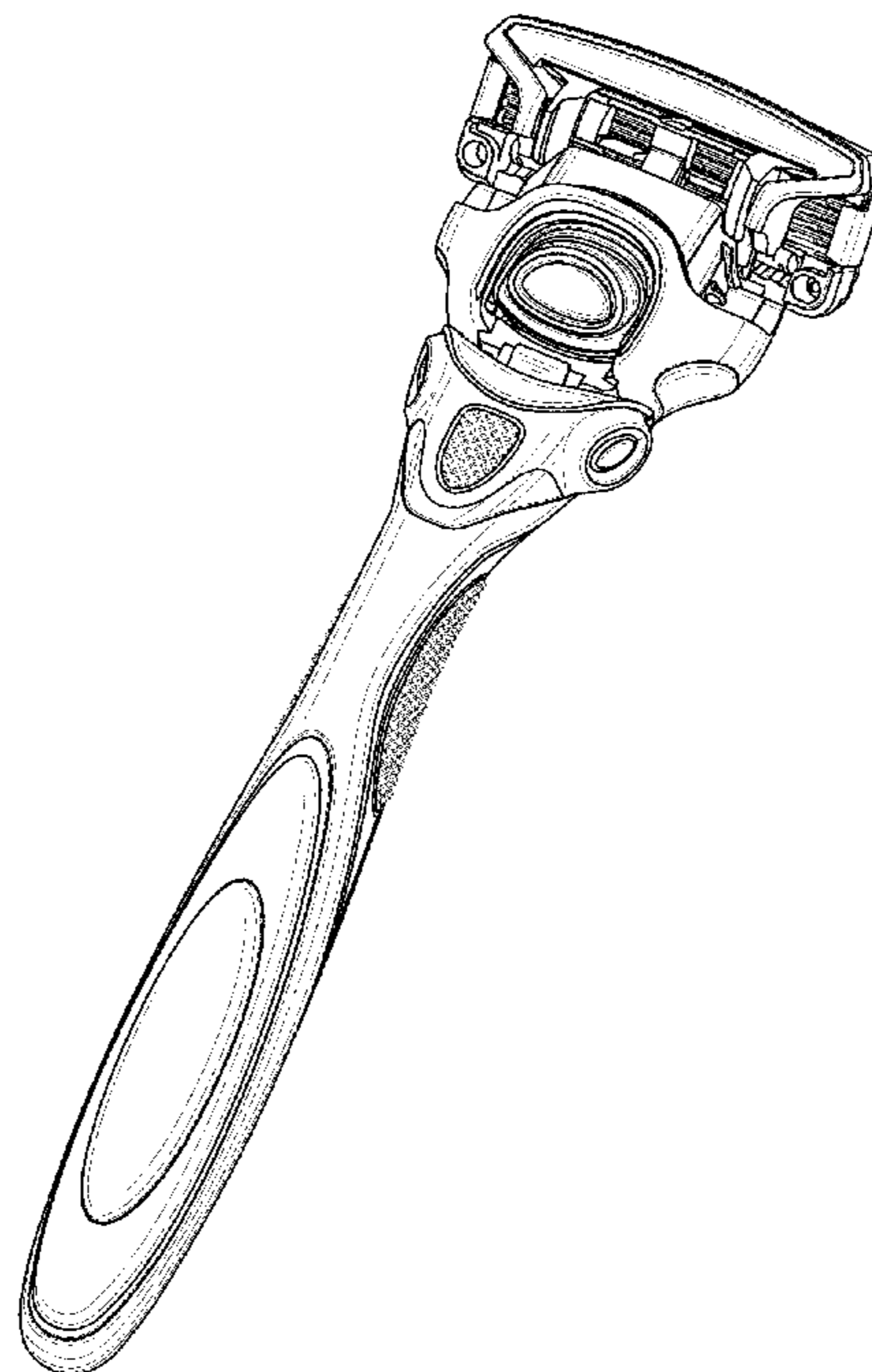

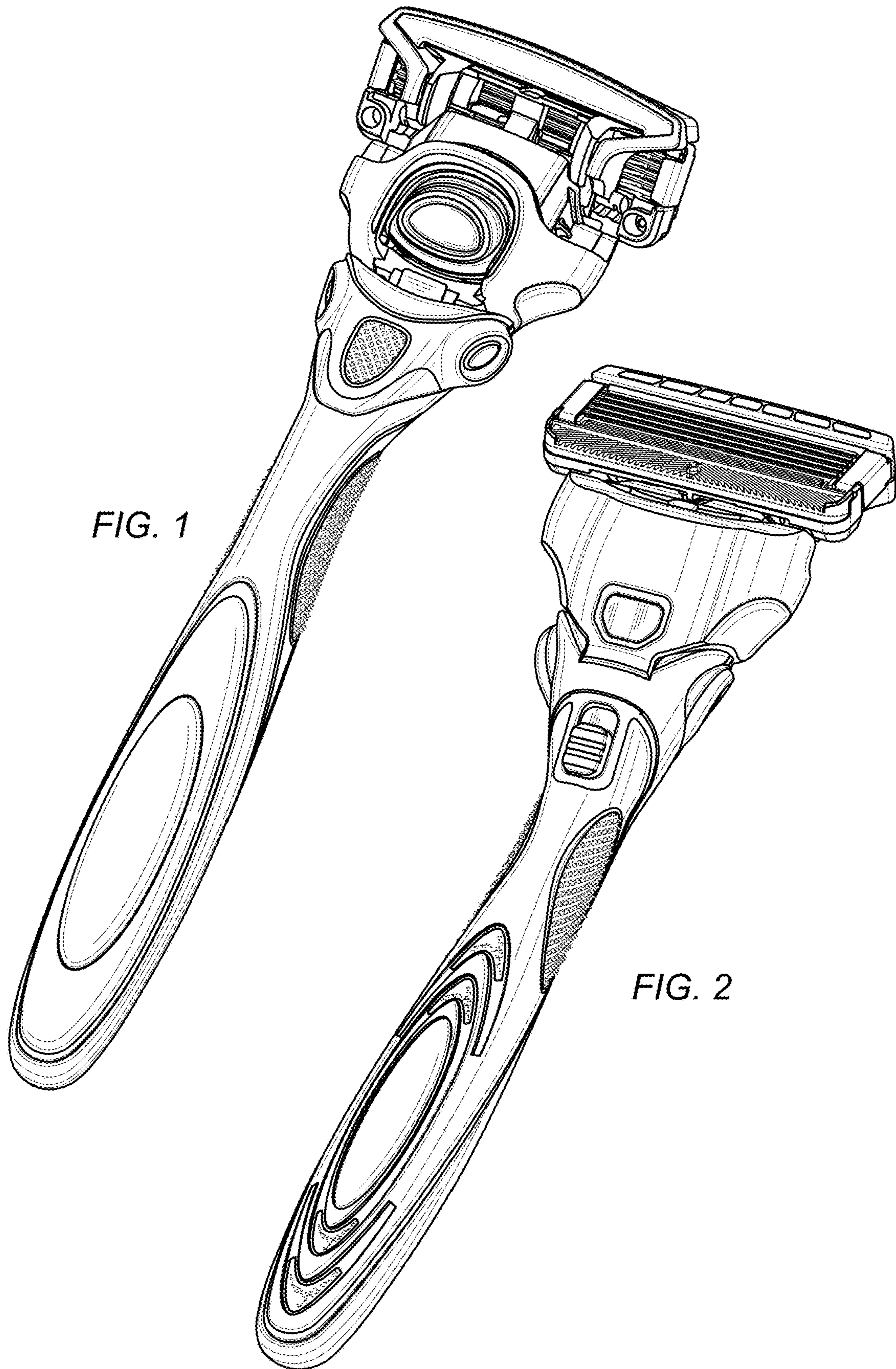

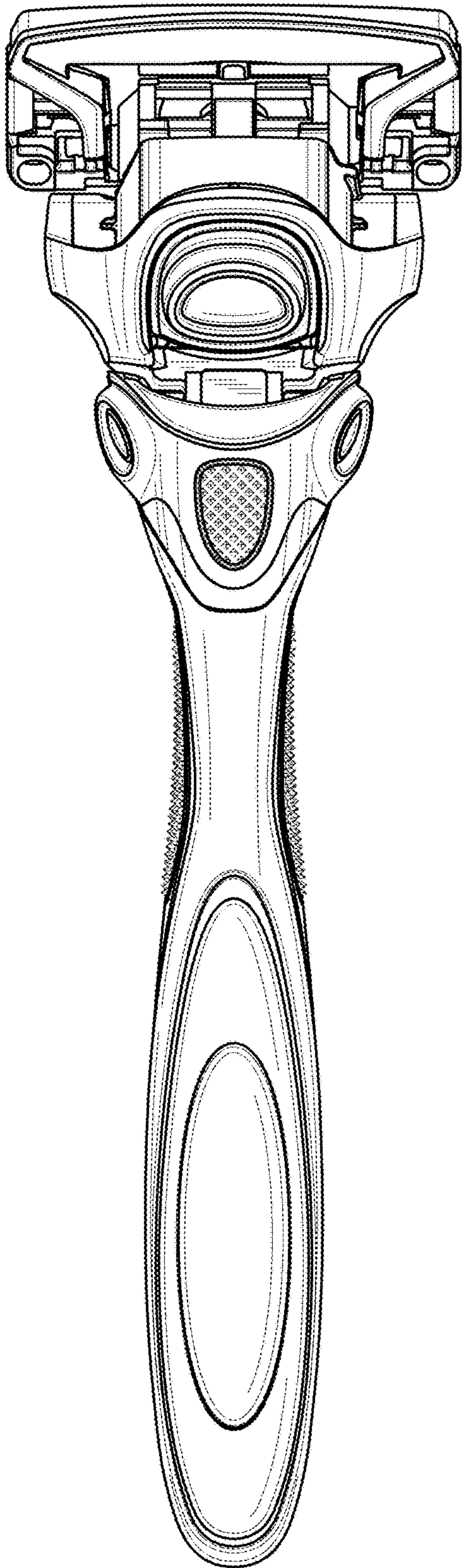

FIG. 3

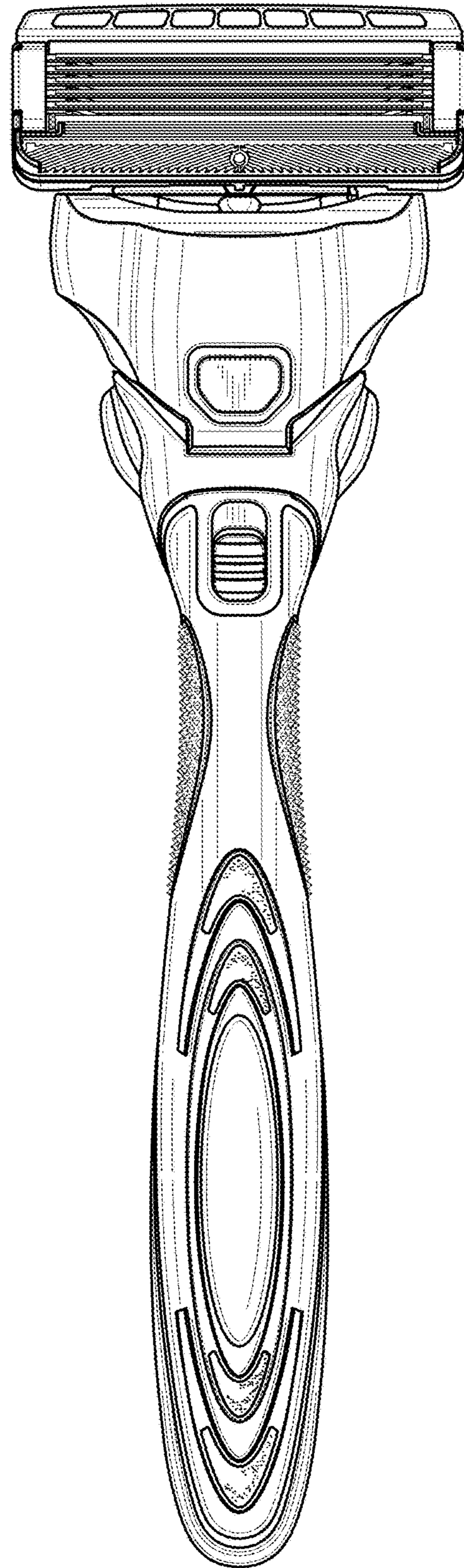

FIG. 4

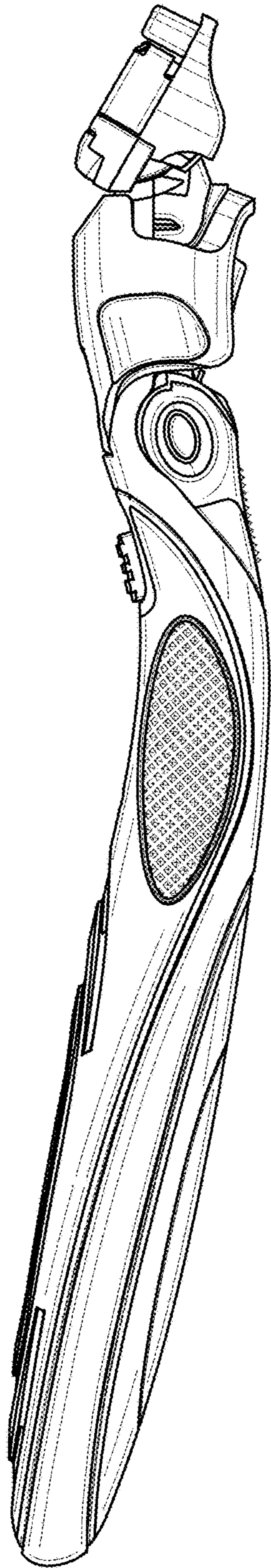

FIG. 5

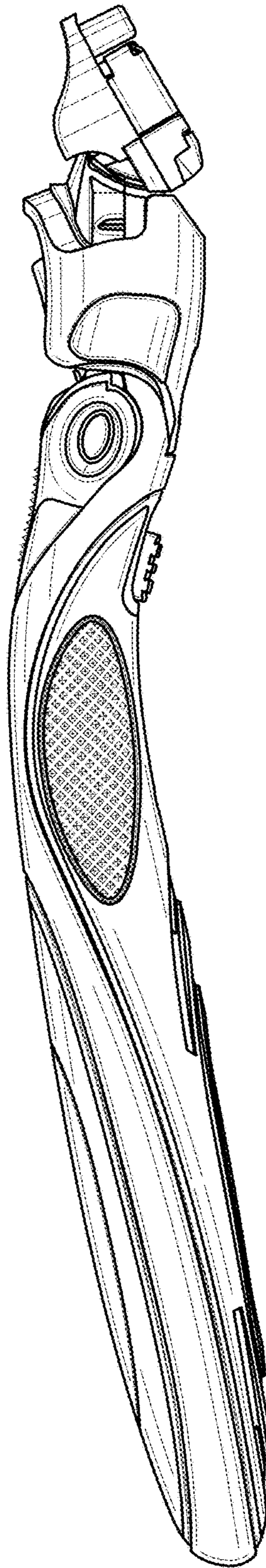

FIG. 6

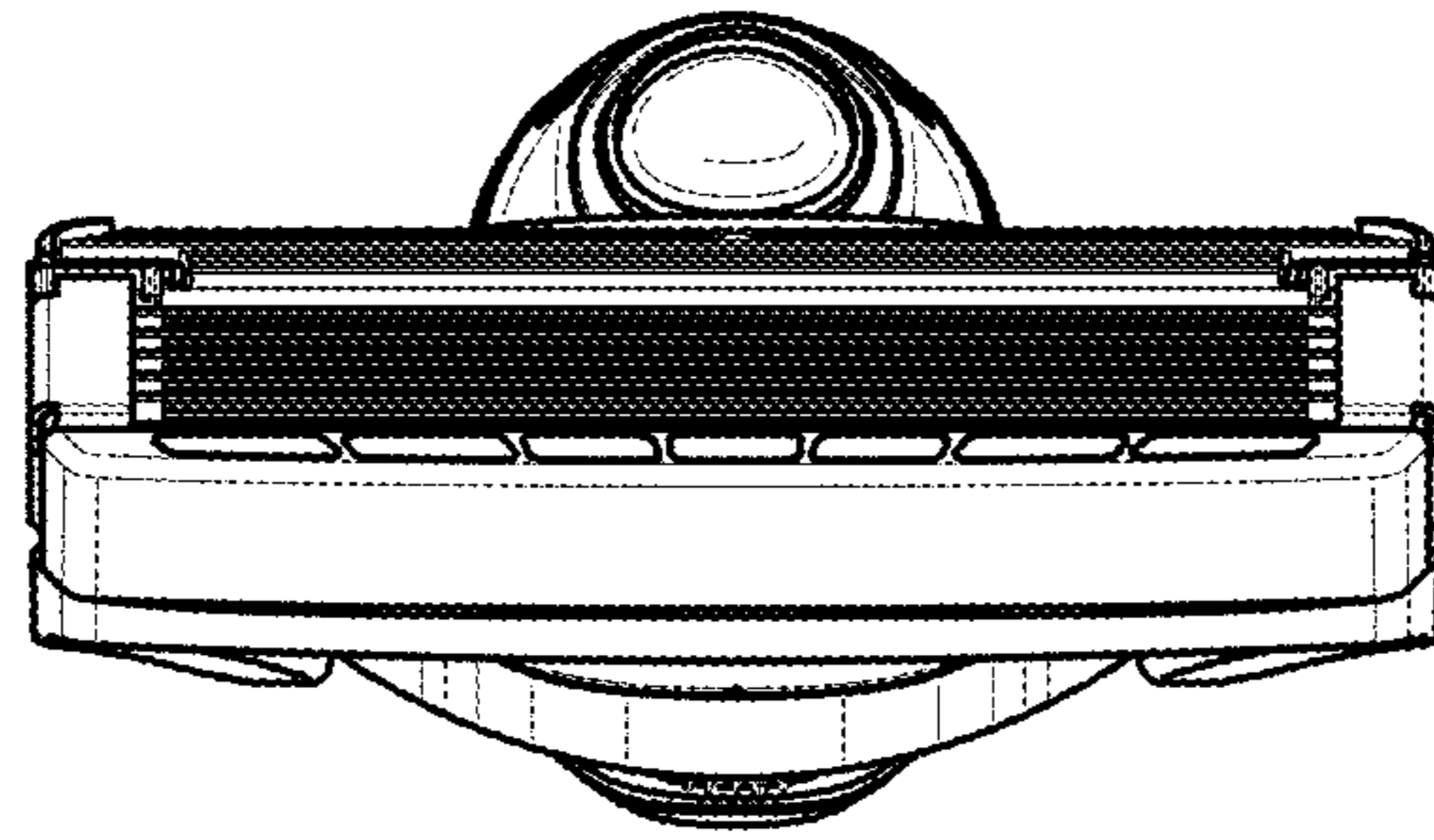

FIG. 7

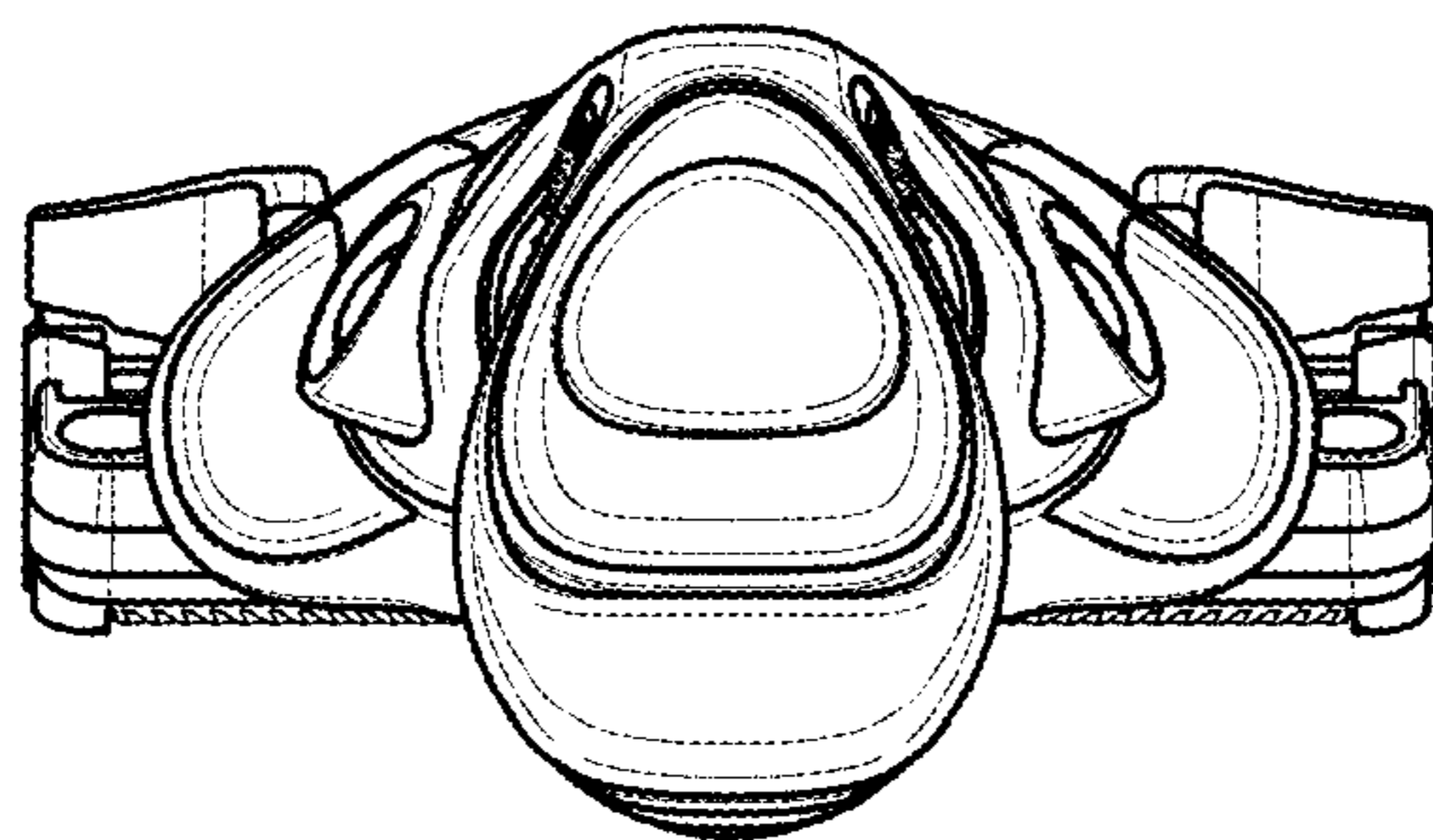

FIG. 8