



US00D848063S

(12) **United States Design Patent** (10) **Patent No.:** **US D848,063 S**
Tappenden et al. (45) **Date of Patent:** **** *May 7, 2019**

(54) **ACCESSORY FOR HAIR STYLING AND HAIR CARE APPARATUS**

(71) Applicant: **Dyson Technology Limited**, Wiltshire (GB)

(72) Inventors: **Benjamin Charles Felix Tappenden**, Bristol (GB); **Britta Jessica Stockinger**, Bath (GB); **Andrea Ee-Va Lim**, Bristol (GB); **Alexander Stuart Knox**, Swindon (GB)

(73) Assignee: **Dyson Technology Limited**, Malmesbury, Wiltshire (GB)

(*) Notice: This patent is subject to a terminal disclaimer.

(**) Term: **15 Years**

(21) Appl. No.: **29/627,664**

(22) Filed: **Nov. 29, 2017**

(30) **Foreign Application Priority Data**

May 30, 2017 (EM) 004024644-0007

(51) **LOC (11) Cl.** **28-03**

(52) **U.S. Cl.**
USPC **D28/18**

(58) **Field of Classification Search**
USPC D28/18, 24, 25, 10, 12, 13, 15, 34;
D4/100, 102, 11, 117, 127, 128;
34/96-98; 132/271, 128, 270; 392/380,
392/383-385
CPC A45D 20/12; A45D 20/00; A45D 20/10;
A45D 20/08
See application file for complete search history.

(56) **References Cited**

U.S. PATENT DOCUMENTS

D256,280 S 8/1980 Haase
D256,846 S 9/1980 Haase

4,232,454 A 11/1980 Springer
D259,665 S 6/1981 Cousins
D277,417 S 1/1985 Wistrand
D322,892 S * 1/1992 Kwok-Fai Au D4/100
5,157,757 A 10/1992 McDougall
D386,816 S * 11/1997 Seifert D28/18
D398,073 S 9/1998 Kip
D398,074 S 9/1998 Nosenchuck

(Continued)

OTHER PUBLICATIONS

Coulton et al, U.S. Office Action dated Sep. 14, 2018, directed to U.S. App. No. 29/627,694; 9 pages.

(Continued)

Primary Examiner — Susan Bennett Hattan
Assistant Examiner — Rebecca Tsehaye
(74) *Attorney, Agent, or Firm* — Morrison & Foerster LLP

(57) **CLAIM**

We claim the ornamental design for an accessory for hair styling and hair care apparatus, as shown and described.

DESCRIPTION

FIG. 1 is a top perspective view of an accessory for hair styling and hair care apparatus showing our new design; FIG. 2 is a bottom perspective view thereof; FIG. 3 is a rear perspective view thereof; FIG. 4 is a side view thereof; FIG. 5 is a top view thereof; FIG. 6 is a bottom view thereof; and, FIG. 7 is a front view thereof. The areas within the dashed lines in FIG. 2 and FIG. 6 form no part of the claimed design. The view opposite the side view of FIG. 4 is a mirror image thereof and, therefore, is omitted. The accessory for hair styling and hair care apparatus is illustrated with grayscale shading to indicate contrast.

1 Claim, 7 Drawing Sheets

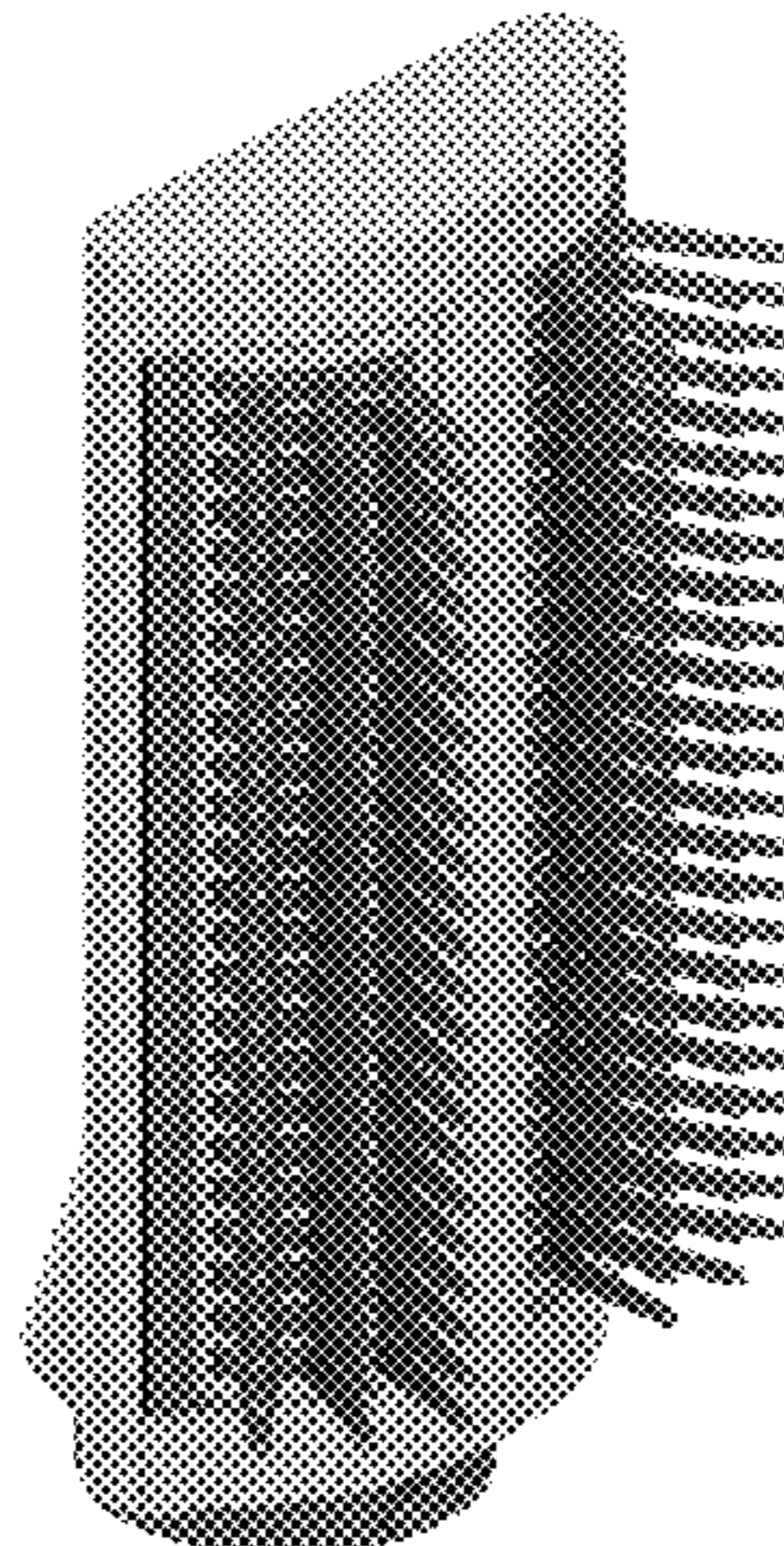

(56)

References Cited

U.S. PATENT DOCUMENTS

D409,796	S *	5/1999	Moreno	D28/18
D425,663	S	5/2000	Greubel et al.		
D439,012	S *	3/2001	McCurrach	D28/13
D439,701	S *	3/2001	Engelen	D28/13
D448,115	S *	9/2001	White	D28/18
D457,730	S *	5/2002	McCurrach	D28/10
6,460,272	B2	10/2002	Cheng		
D476,443	S *	6/2003	Ohta	D28/18
6,662,811	B2 *	12/2003	Mugge	A45D 24/22 132/228
D506,030	S	6/2005	Lai		
D510,192	S *	10/2005	Kampel	D4/128
6,962,159	B1	11/2005	Adam		
7,096,598	B1 *	8/2006	Myatt	A45D 20/52 34/96
D557,017	S *	12/2007	Kampel	D4/128
D609,857	S	2/2010	Schmitz		
D676,600	S	2/2013	Thrasher, Jr.		
D700,018	S	2/2014	Thrash		
D754,313	S	4/2016	Ellis et al.		
D775,418	S	12/2016	Stephens et al.		
D775,419	S	12/2016	Stephens et al.		
D776,345	S	1/2017	Tang		
D782,731	S	3/2017	Smith et al.		
D782,732	S	3/2017	Smith et al.		
D782,733	S	3/2017	Smith et al.		
D782,734	S	3/2017	Sutter et al.		
D790,785	S	6/2017	Courtney et al.		
D791,407	S	7/2017	Smith et al.		
D798,502	S	9/2017	Smith et al.		
D800,454	S	10/2017	Mathieu		
9,808,067	B2	11/2017	Sutter et al.		
D810,927	S	2/2018	Ross et al.		
D811,009	S	2/2018	Smith et al.		
D814,130	S	3/2018	Taub		
D815,837	S	4/2018	Zhou		
D817,643	S *	5/2018	Valle	D4/100
9,986,810	B2	6/2018	Bobillier et al.		
D823,004	S *	7/2018	Kuo	D4/128
D823,005	S *	7/2018	Kuo	D4/128
10,021,951	B2	7/2018	Bobillier et al.		
10,028,574	B2 *	7/2018	Rennette	A46B 9/023
2014/0083446	A1	3/2014	Julemont et al.		
2016/0166033	A1	6/2016	Kerr et al.		
2016/0166035	A1	6/2016	Douglas et al.		
2016/0206075	A1	7/2016	Stephens et al.		
2016/0206076	A1	7/2016	Stephens et al.		
2016/0206077	A1	7/2016	Stephens et al.		
2016/0338464	A1	11/2016	Wilkinson et al.		
2016/0338465	A1	11/2016	Wilkinson et al.		
2017/0112256	A1	4/2017	Bobillier et al.		
2017/0164709	A1	6/2017	Laveni et al.		
2017/0273422	A1	9/2017	Heffer et al.		
2017/0273425	A1	9/2017	Stephens et al.		
2017/0273428	A1	9/2017	Nicolson et al.		
2017/0273429	A1	9/2017	Nicolson et al.		
2017/0273431	A1	9/2017	Courtney et al.		
2018/0055181	A1	3/2018	Spark et al.		
2018/0055184	A1	3/2018	McVeigh et al.		

OTHER PUBLICATIONS

Coulton et al., U.S. Office Action dated Aug. 31, 2018, directed to U.S. Appl. No. 29/627,665; 8 pages.
Coulton et al., U.S. Office Action dated Aug. 8, 2018, directed to U.S. Appl. No. 29/627,693; 9 pages.
Coulton et al., U.S. Office Action dated Oct. 30, 2018, directed to U.S. Appl. No. 29/627,739; 7 pages.

Coulton et al., U.S. Office Action dated Oct. 30, 2018, directed to U.S. Appl. No. 29/627,749; 7 pages.
Coulton et al., U.S. Office Action dated Oct. 30, 2018, directed to U.S. Appl. No. 29/627,752; 7 pages.
Coulton et al., U.S. Office Action dated Oct. 30, 2018, directed to U.S. Appl. No. 29/627,754; 7 pages.
Coulton et al., U.S. Office Action dated Oct. 30, 2018, directed to U.S. Appl. No. 29/627,773; 8 pages.
Coulton et al., U.S. Office Action dated Sep. 10, 2018, directed to U.S. Appl. No. 29/627,690; 7 pages.
Coulton et al., U.S. Office Action dated Sep. 14, 2018, directed to U.S. Appl. No. 29/627,707; 9 pages.
Heffer et al., U.S. Office Action dated Aug. 16, 2018, directed to U.S. Appl. No. 29/627,688; 8 pages.
Heffer et al., U.S. Office Action dated Aug. 16, 2018, directed to U.S. Appl. No. 29/627,712; 8 pages.
Heffer et al., U.S. Office Action dated Aug. 16, 2018, directed to U.S. Appl. No. 29/627,713; 8 pages.
Heffer et al., U.S. Office Action dated Aug. 16, 2018, directed to U.S. Appl. No. 29/627,730; 8 pages.
Tappenden et al., U.S. Office Action dated Oct. 17, 2018, directed to U.S. Appl. No. 29/627,727; 6 pages.
Tappenden et al., U.S. Office Action dated Aug. 8, 2018, directed to U.S. Appl. No. 29/627,660; 7 pages.
Tappenden et al., U.S. Office Action dated Aug. 8, 2018, directed to U.S. Appl. No. 29/627,668; 7 pages.
Tappenden et al., U.S. Office Action dated Aug. 8, 2018, directed to U.S. Appl. No. 29/627,671; 7 pages.
Tappenden et al., U.S. Office Action dated Aug. 8, 2018, directed to U.S. Appl. No. 29/627,673; 7 pages.
Tappenden et al., U.S. Office Action dated Aug. 8, 2018, directed to U.S. Appl. No. 29/627,677; 7 pages.
Tappenden et al., U.S. Office Action dated Aug. 8, 2018, directed to U.S. Appl. No. 29/627,678; 7 pages.
Tappenden et al., U.S. Office Action dated Aug. 8, 2018, directed to U.S. Appl. No. 29/627,714; 7 pages.
Tappenden et al., U.S. Office Action dated Oct. 1, 2018, directed to U.S. Appl. No. 29/627,717; 6 pages.
Tappenden et al., U.S. Office Action dated Oct. 17, 2018, directed to U.S. Appl. No. 29/627,723; 6 pages.
Tappenden et al., U.S. Office Action dated Oct. 17, 2018, directed to U.S. Appl. No. 29/627,731; 6 pages.
Tappenden et al., U.S. Office Action dated Oct. 17, 2018, directed to U.S. Appl. No. 29/627,733; 6 pages.
Tappenden et al., U.S. Office Action dated Oct. 17, 2018, directed to U.S. Appl. No. 29/627,734; 6 pages.
Tappenden et al., U.S. Office Action dated Oct. 17, 2018, directed to U.S. Appl. No. 29/627,735; 6 pages.
Tappenden et al., U.S. Office Action dated Sep. 27, 2018, directed to U.S. Appl. No. 29/627,700; 6 pages.
Tappenden et al., U.S. Office Action dated Sep. 27, 2018, directed to U.S. Appl. No. 29/627,702; 6 pages.
Tappenden et al., U.S. Office Action dated Sep. 27, 2018, directed to U.S. Appl. No. 29/627,705; 6 pages.
Tappenden et al., U.S. Office Action dated Sep. 27, 2018, directed to U.S. Appl. No. 29/627,706; 6 pages.
Tappenden et al., U.S. Office Action dated Sep. 27, 2018, directed to U.S. Appl. No. 29/627,710; 6 pages.
Tappenden et al., U.S. Office Action dated Sep. 27, 2018, directed to U.S. Appl. No. 29/627,724; 6 pages.
Tappenden et al., U.S. Office Action dated Sep. 27, 2018, directed to U.S. Appl. No. 29/627,725; 6 pages.
Tappenden et al., U.S. Office Action dated Sep. 27, 2018, directed to U.S. Appl. No. 29/627,726; 6 pages.
Tappenden et al., U.S. Office Action dated Sep. 28, 2018, directed to U.S. Appl. No. 29/627,719; 6 pages.

* cited by examiner

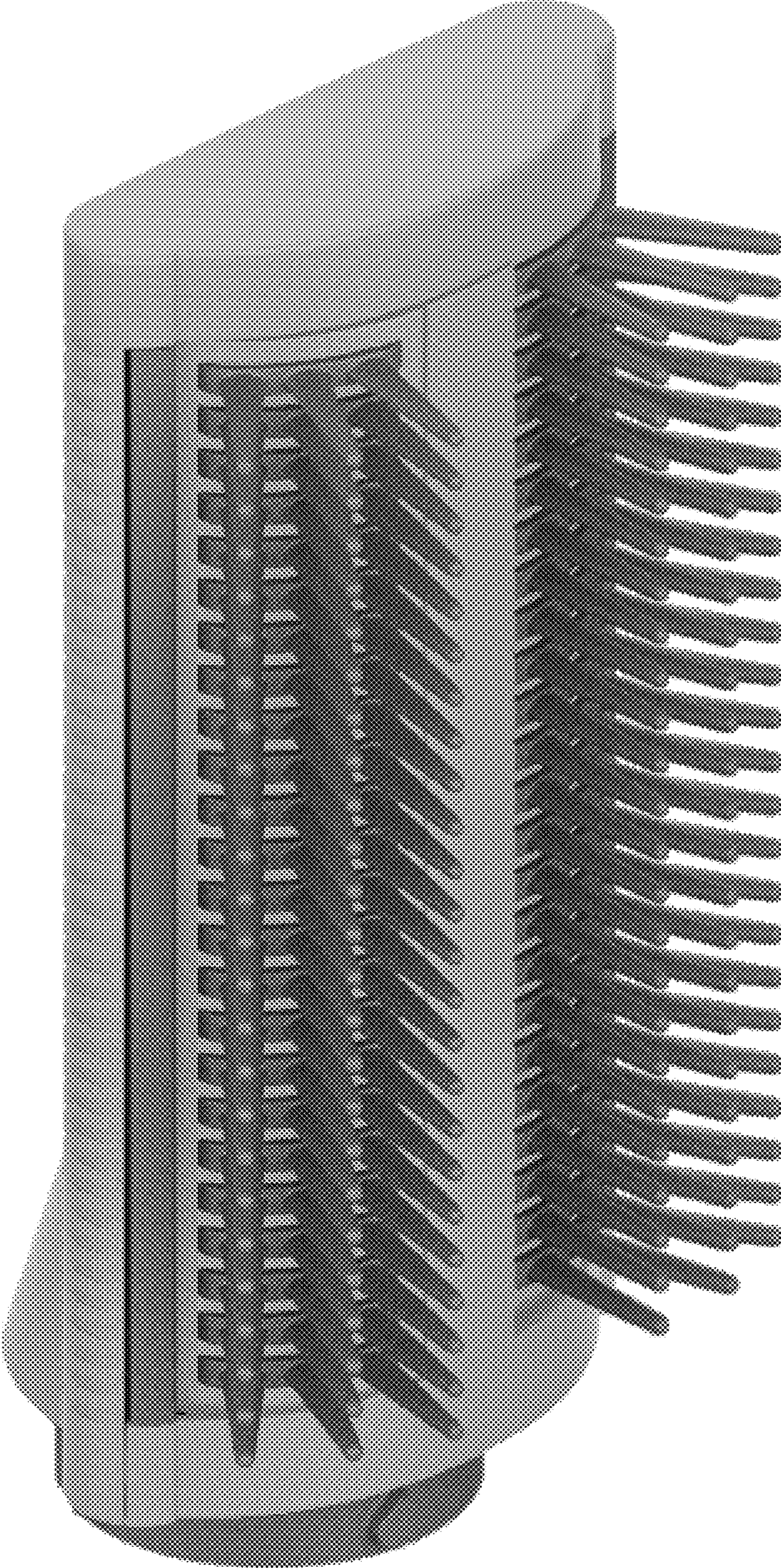

FIG. 1

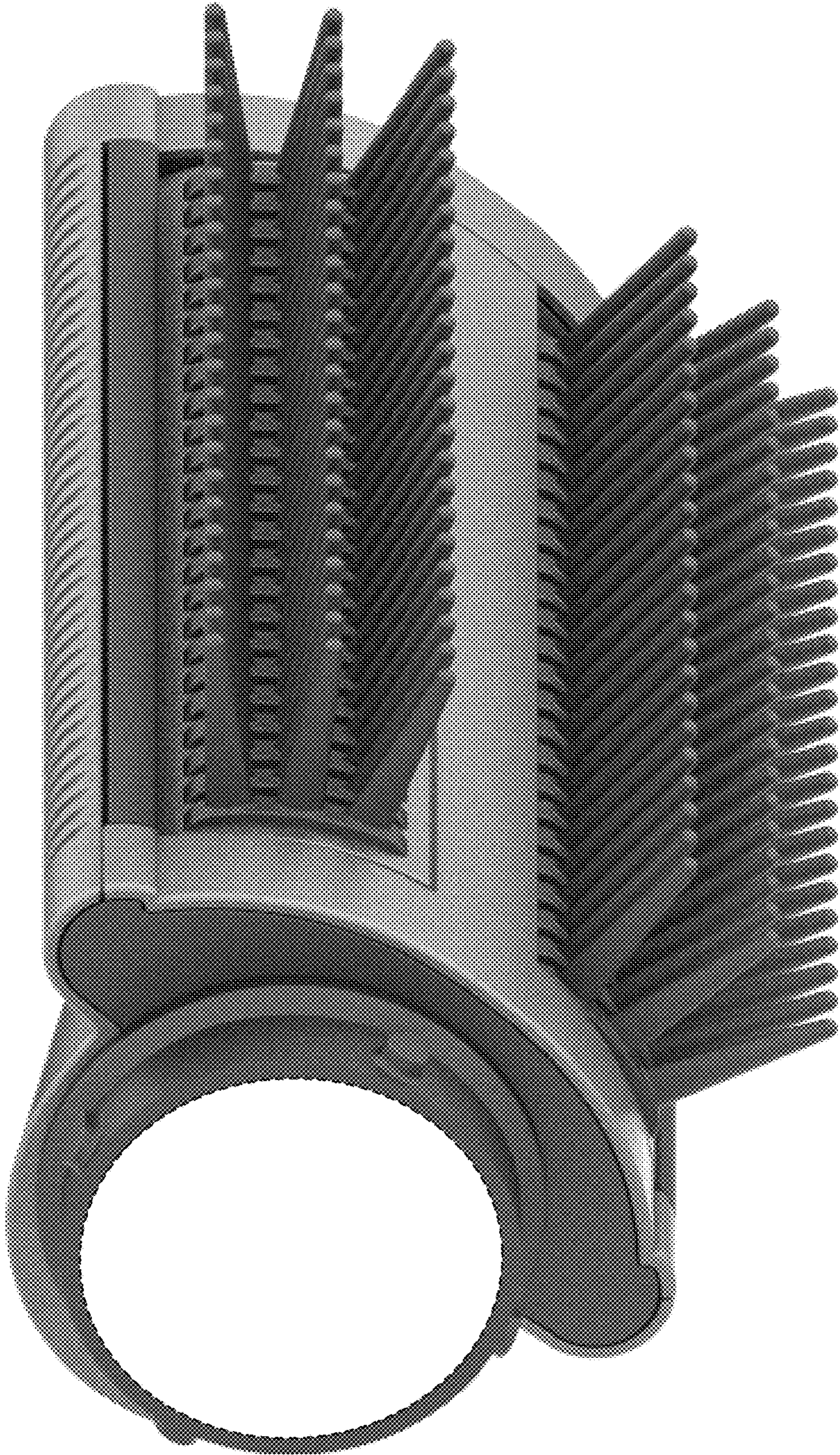

FIG. 2

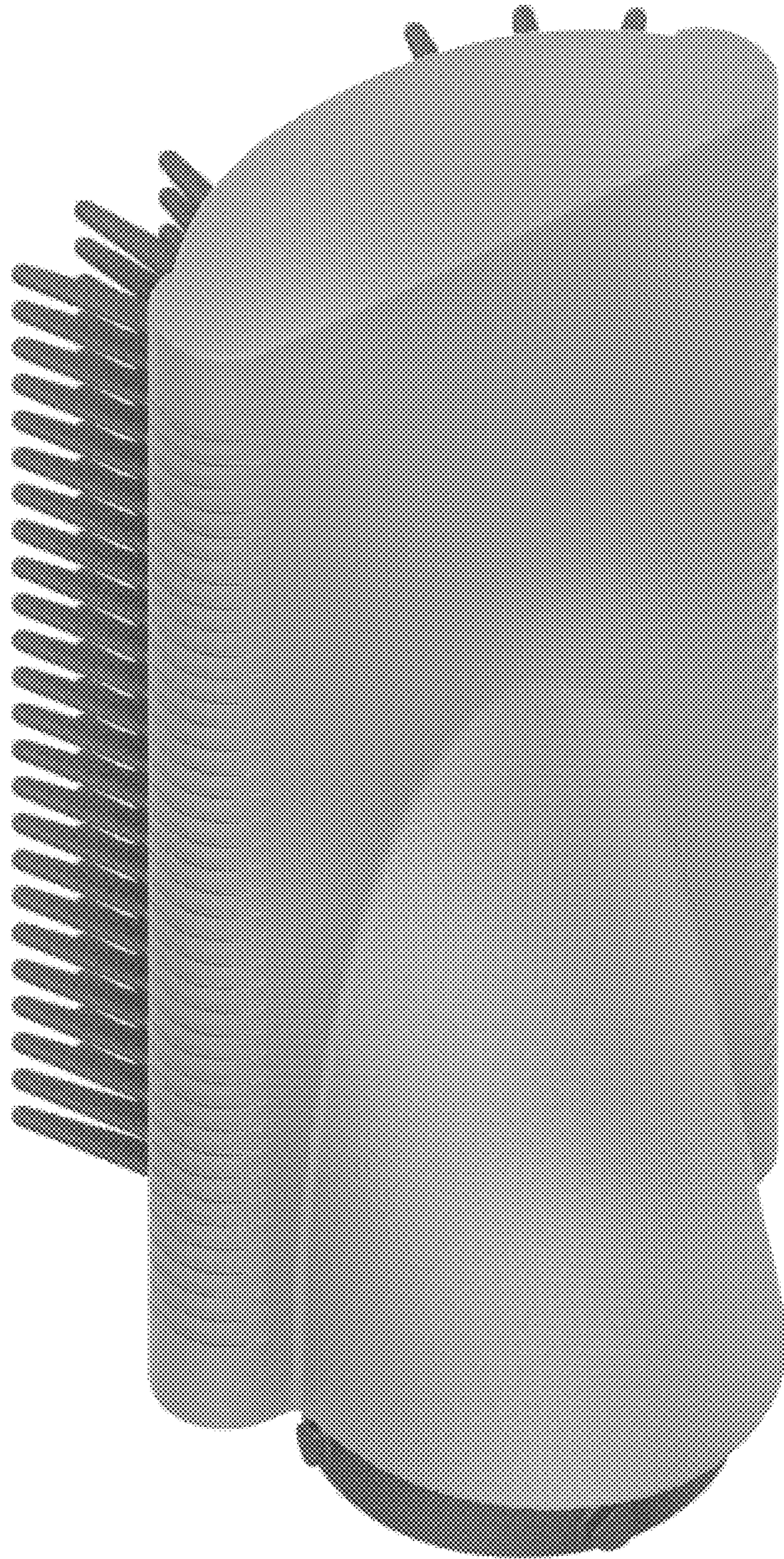

FIG. 3

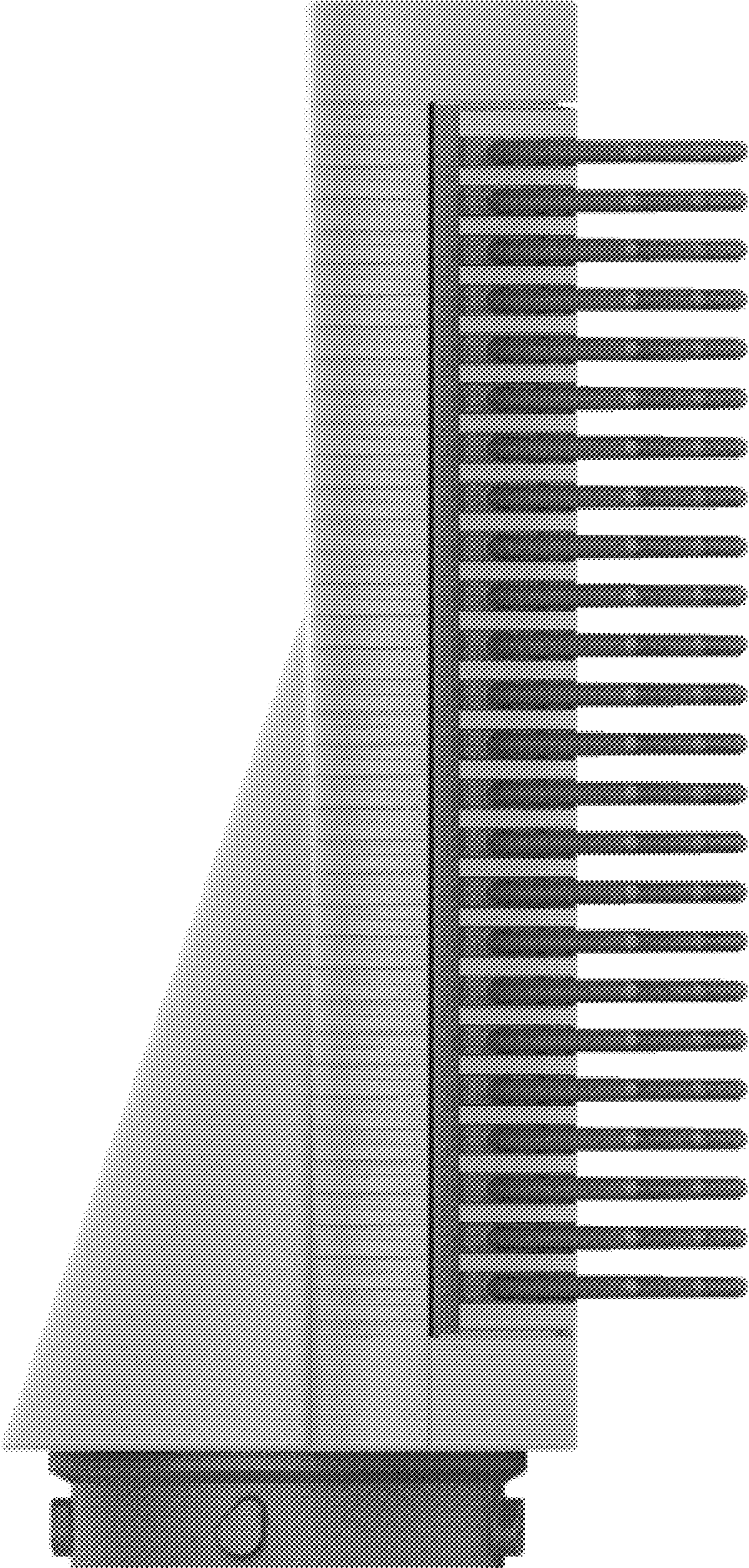

FIG. 4

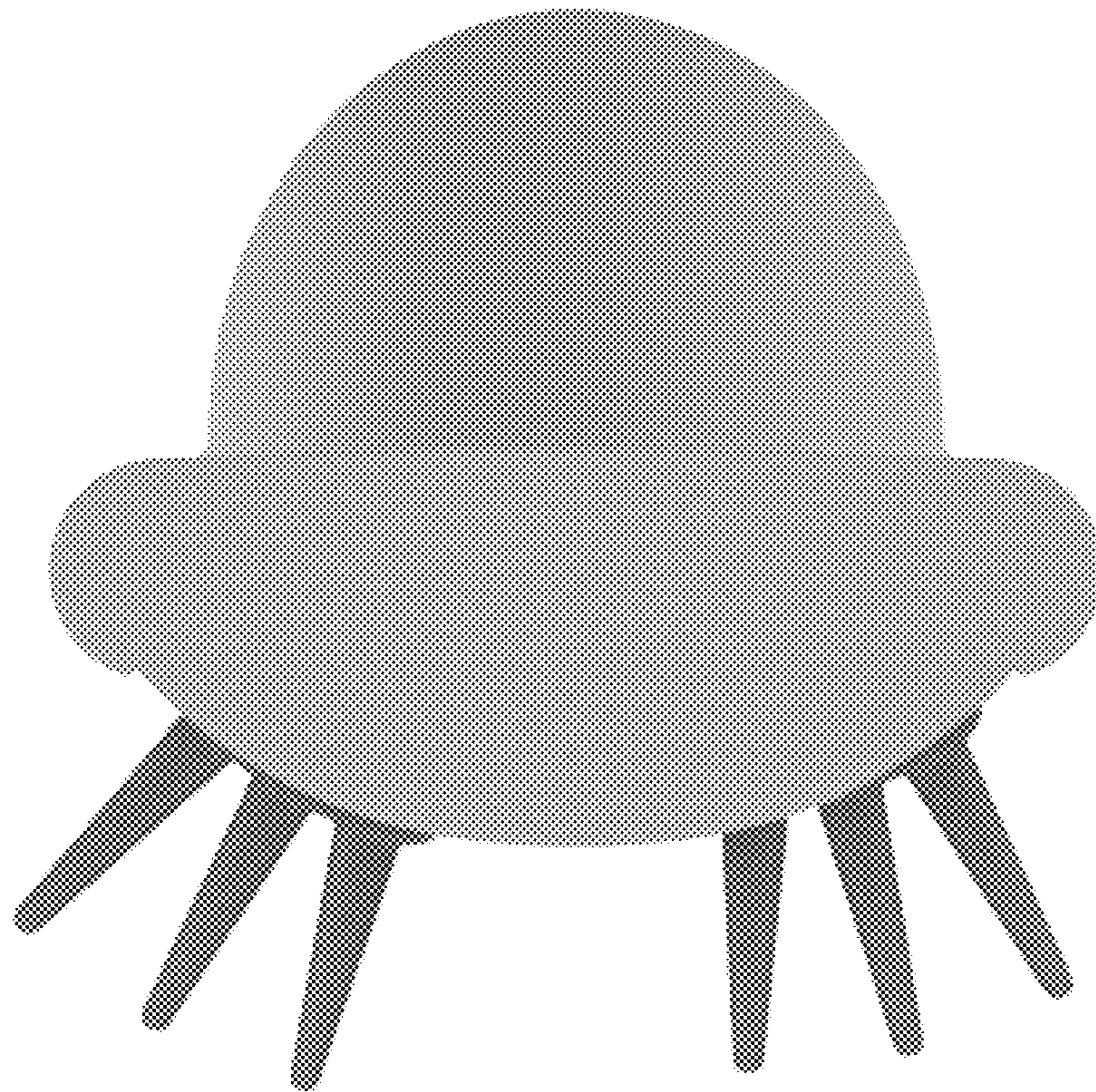

FIG. 5

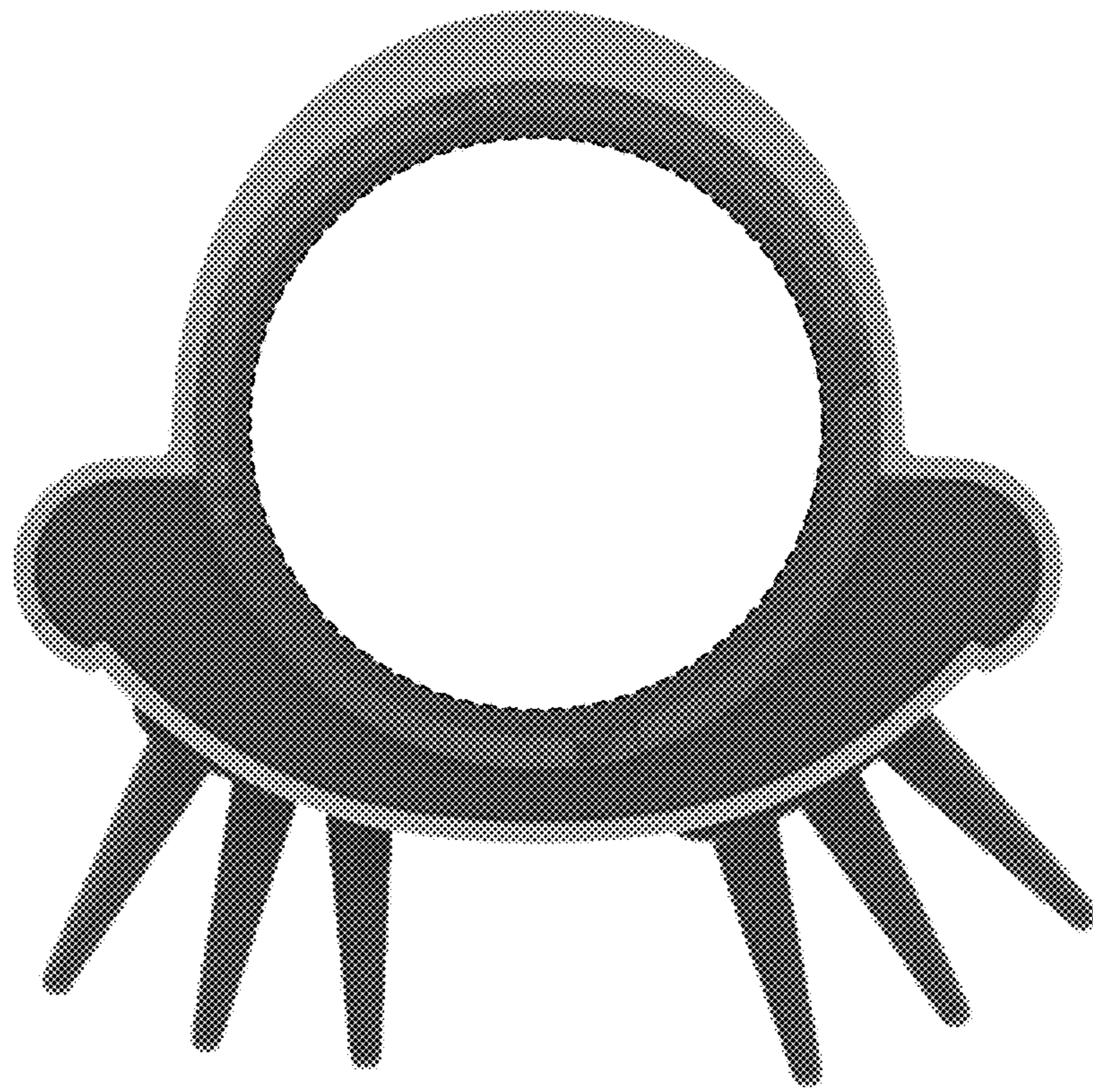

FIG. 6

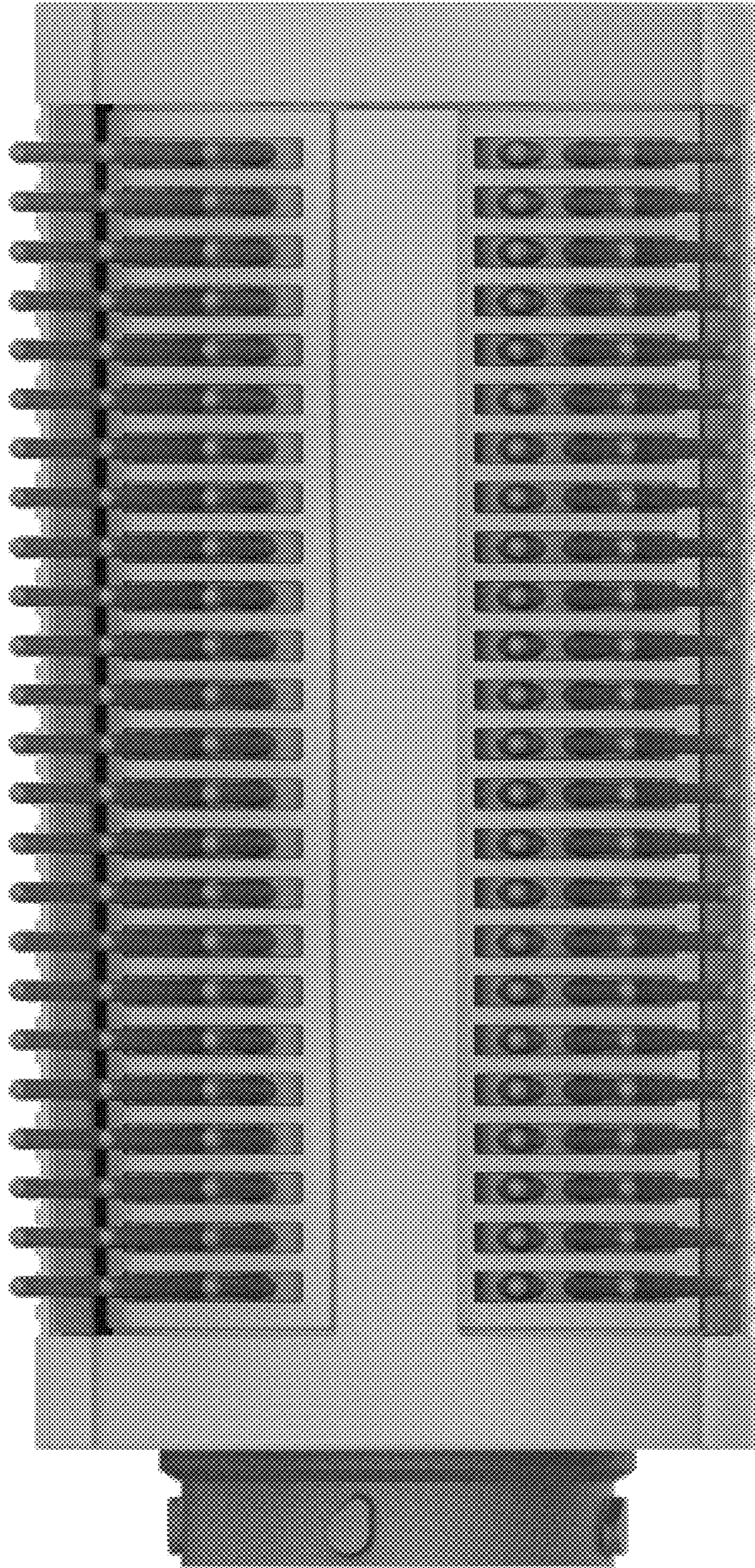

FIG. 7