

US00D847981S

(12) **United States Design Patent** (10) **Patent No.:** **US D847,981 S**
Calvert et al. (45) **Date of Patent:** **** May 7, 2019**

(54) **SAFETY PEN NEEDLE**

(71) Applicant: **Owen Mumford Limited**, Woodstock, Oxfordshire (GB)

(72) Inventors: **Jack Calvert**, Woodstock (GB); **Rosie Hutt**, Woodstock (GB)

(73) Assignee: **Owen Mumford Limited**, Woodstock, Oxfordshire (GB)

(**) Term: **15 Years**

(21) Appl. No.: **29/573,889**

(22) Filed: **Aug. 10, 2016**

(51) **LOC (11) Cl.** **24-02**

(52) **U.S. Cl.**
USPC **D24/127**

(58) **Field of Classification Search**
USPC D24/127-131, 112-114, 133, 186; 606/181, 185; 604/264, 523-528, 272, 604/187, 158, 164.01-164.11, 181, 184, 604/227; 600/101, 139, 143; 128/200.24, 207.14, 207.15
CPC .. A61M 5/3202; A61M 5/3257; A61M 25/00; A61M 39/00; A61M 27/00; A61M 25/0043; A61M 25/0067; A61M 25/0097; A61F 2/958
See application file for complete search history.

8,491,535 B2 * 7/2013 Limaye A61M 5/3243 604/198

8,632,503 B2 * 1/2014 Ruan A61M 5/326 604/198

8,801,673 B2 * 8/2014 Zaiken A61M 5/3257 604/110

8,840,590 B2 * 9/2014 Richards A61M 5/3257 604/198

8,858,510 B2 * 10/2014 Karlsson A61M 5/326 604/198

8,876,781 B2 * 11/2014 Karlsson A61M 5/326 604/198

9,078,983 B2 * 7/2015 Herr A61M 5/24

9,272,100 B2 * 3/2016 Herr A61M 5/3202

9,623,194 B2 * 4/2017 Srinivasan A61M 5/3202

9,649,452 B2 * 5/2017 Srinivasan A61M 5/321

10,022,505 B2 * 7/2018 Hu A61M 5/32

* cited by examiner

Primary Examiner — David G Muller
 (74) *Attorney, Agent, or Firm* — Nexsen Pruet, PLLC; E. Eric Mills

(57) **CLAIM**

The ornamental design for a safety pen needle, as shown and described.

DESCRIPTION

FIG. 1 is a first perspective view of a safety pen needle package showing the new design;
 FIG. 2 is a second perspective view thereof;
 FIG. 3 is a first side view thereof;
 FIG. 4 is a second side view thereof;
 FIG. 5 is a third side view thereof;
 FIG. 6 is a fourth side view thereof;
 FIG. 7 is a top view thereof; and,
 FIG. 8 is a bottom view thereof.

1 Claim, 8 Drawing Sheets

(56) **References Cited**
 U.S. PATENT DOCUMENTS
 7,462,168 B2 * 12/2008 Stonehouse A61M 5/326 604/192
 7,540,858 B2 * 6/2009 DiBiasi A61M 5/326 604/192

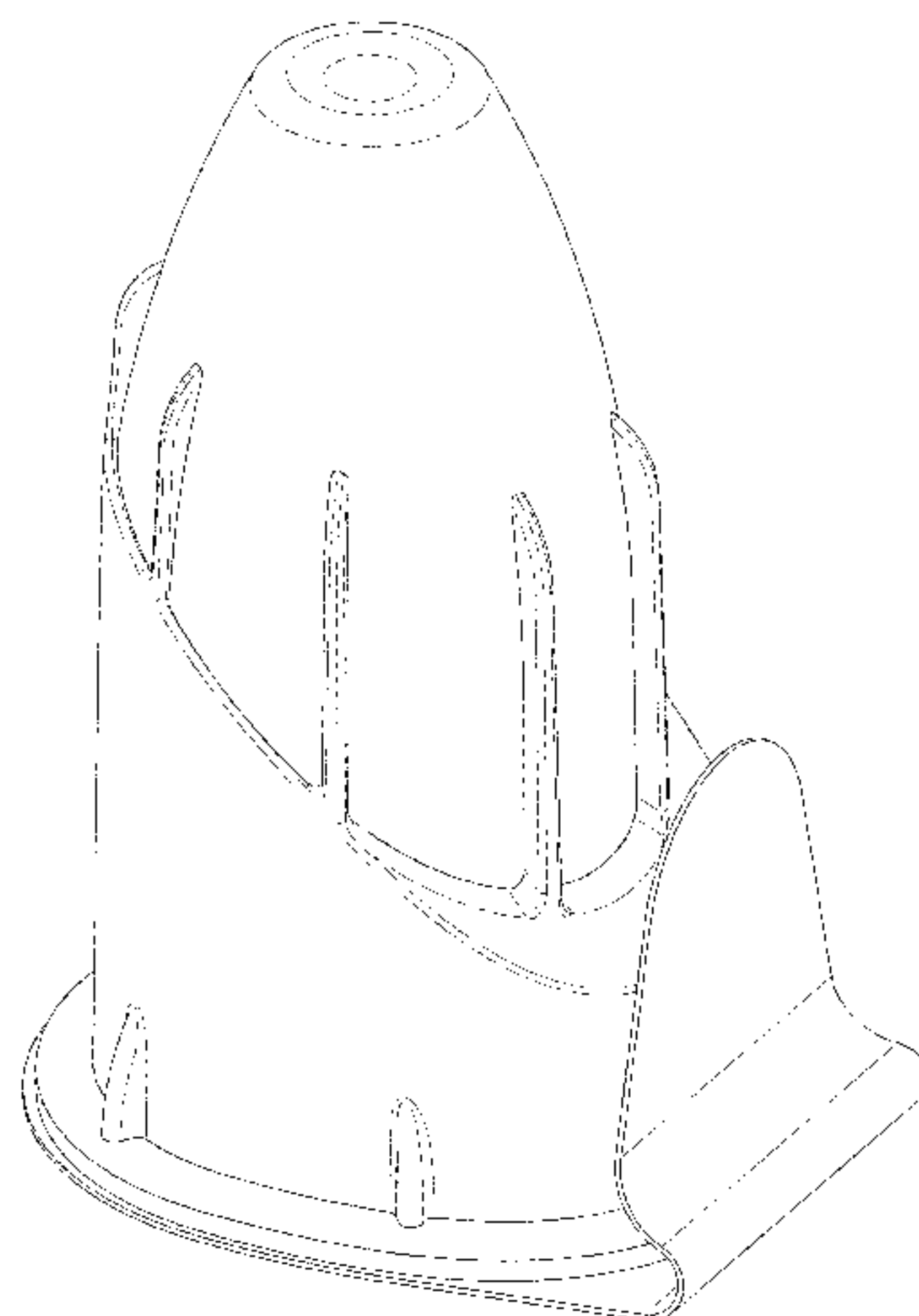

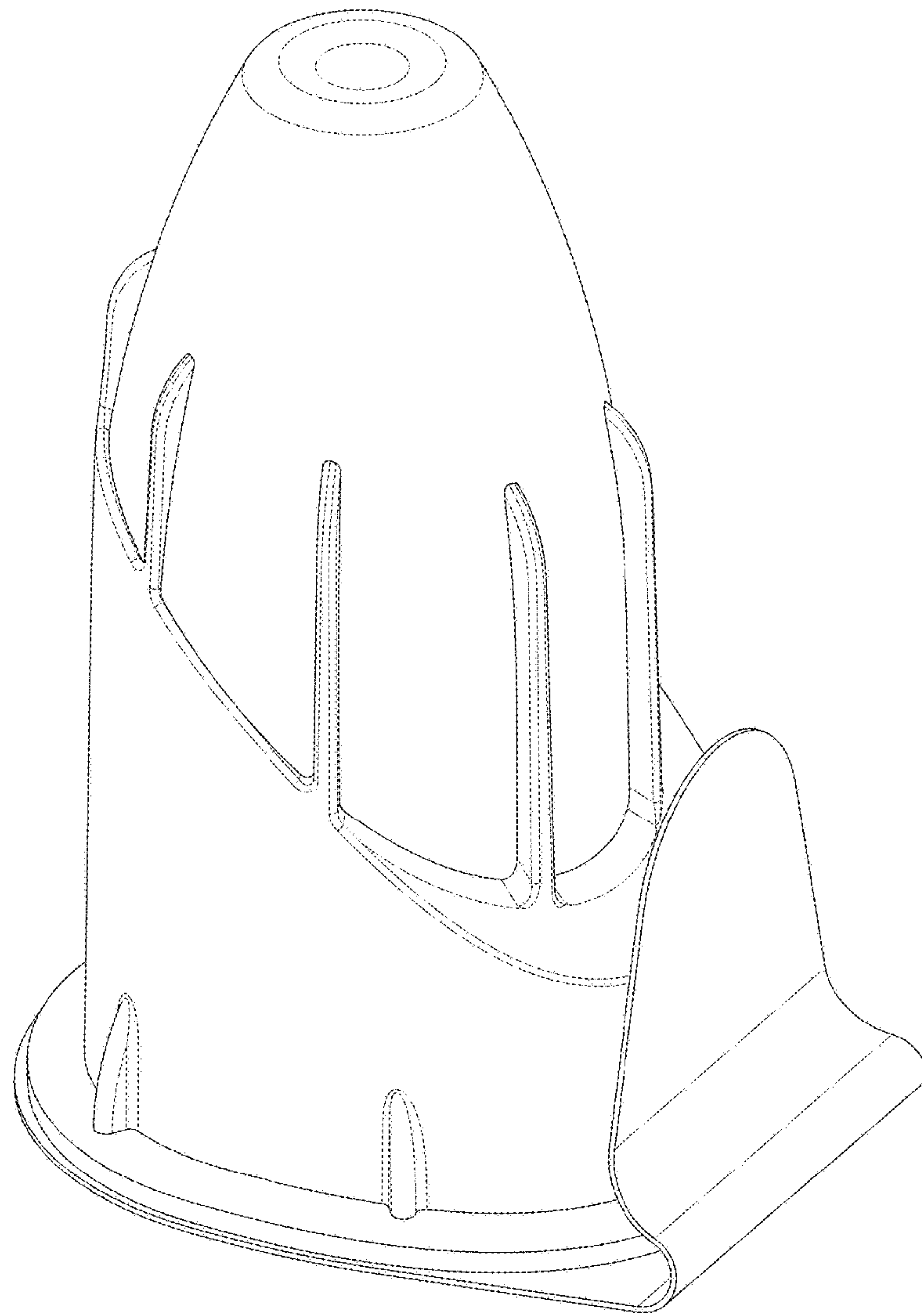

FIG. 1

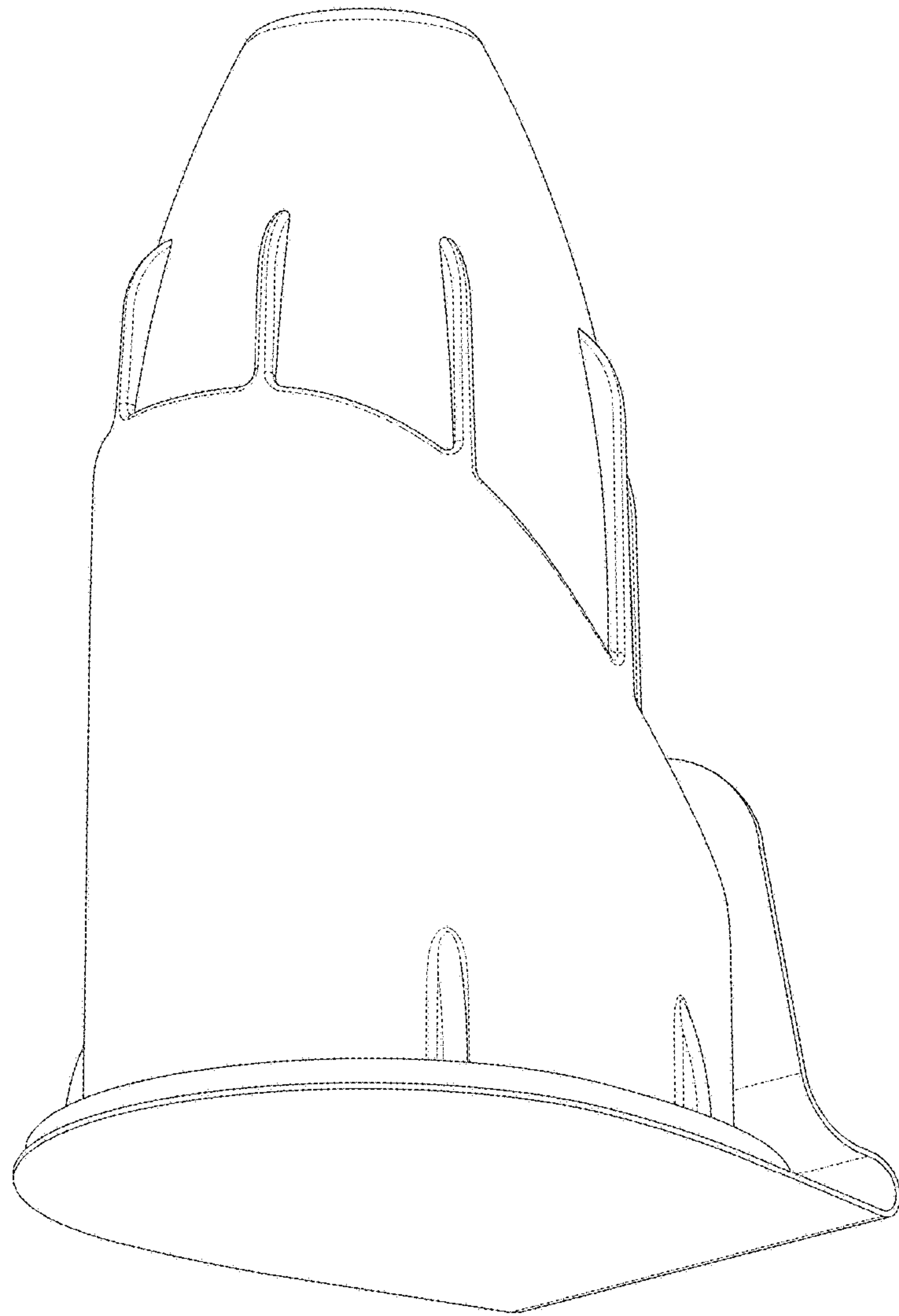

FIG. 2

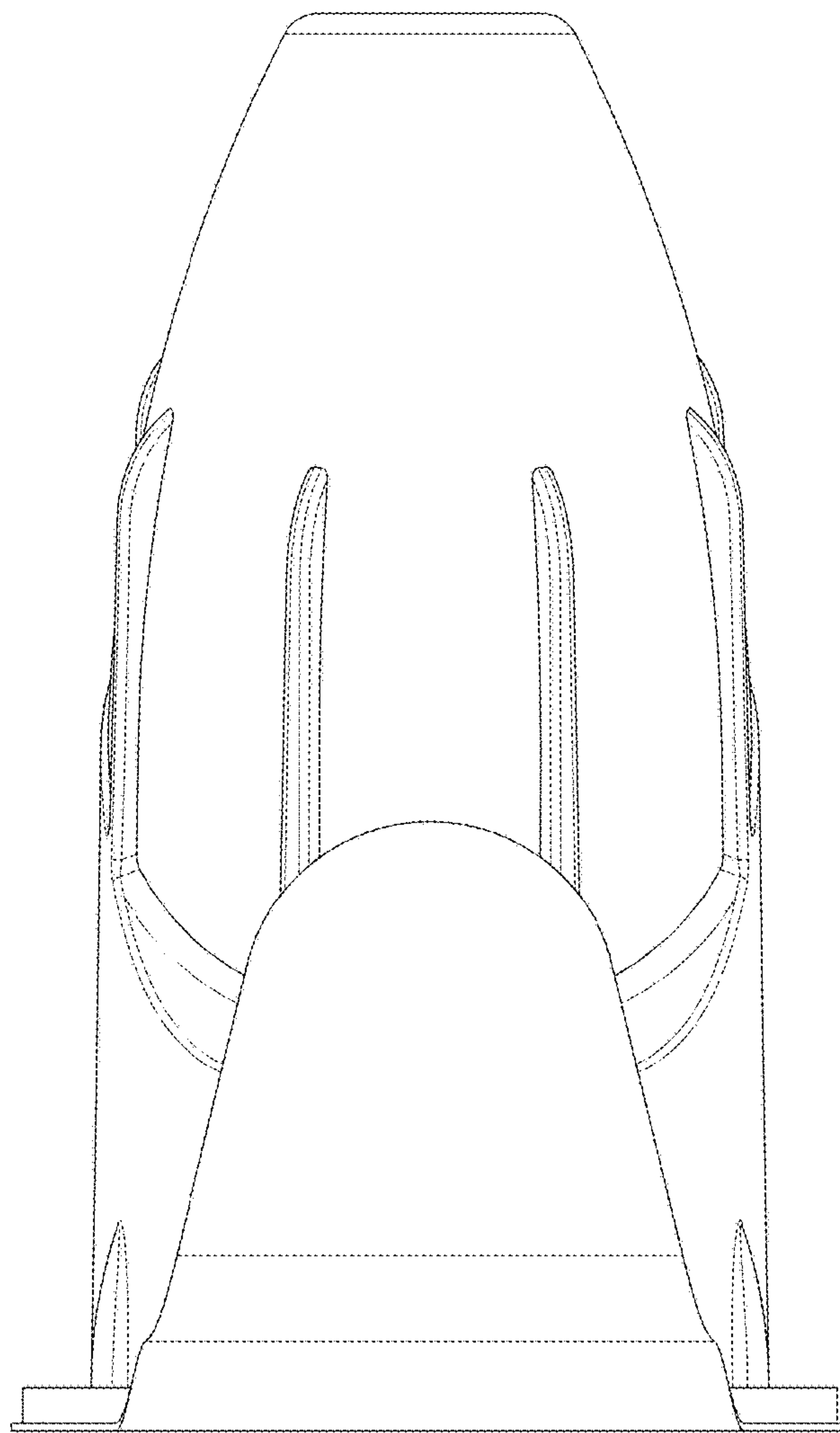

FIG. 3

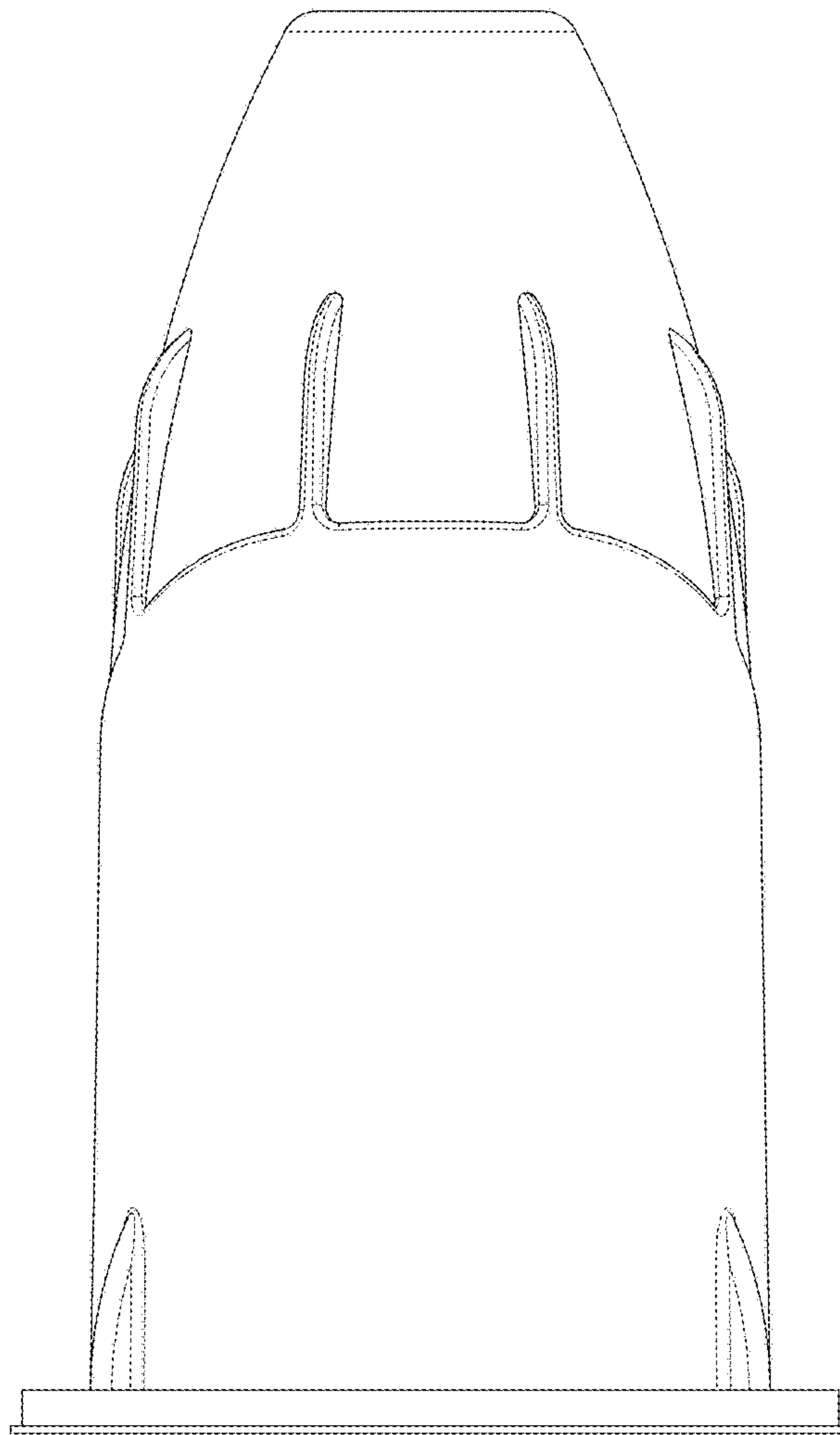

FIG. 4

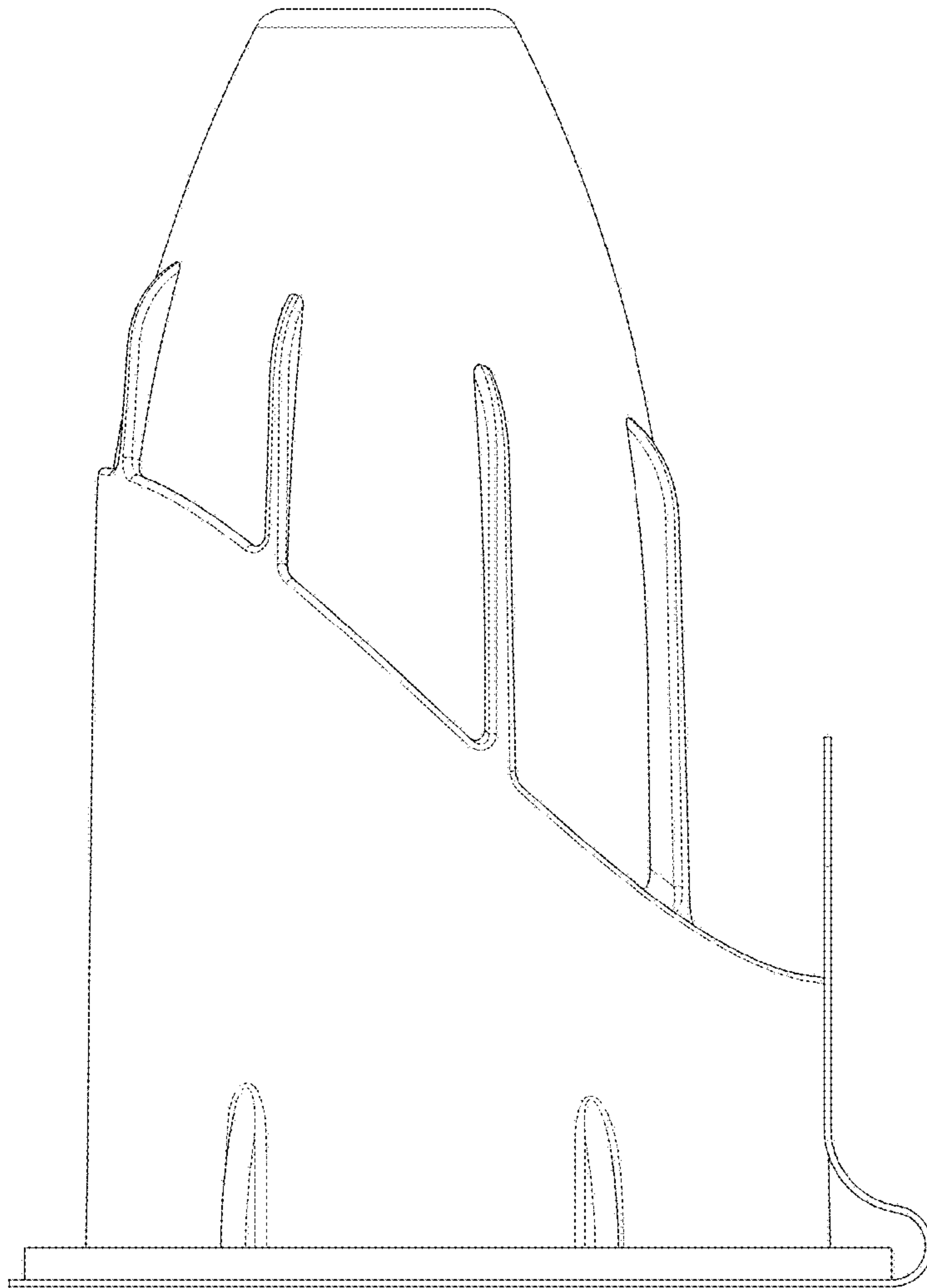

FIG. 5

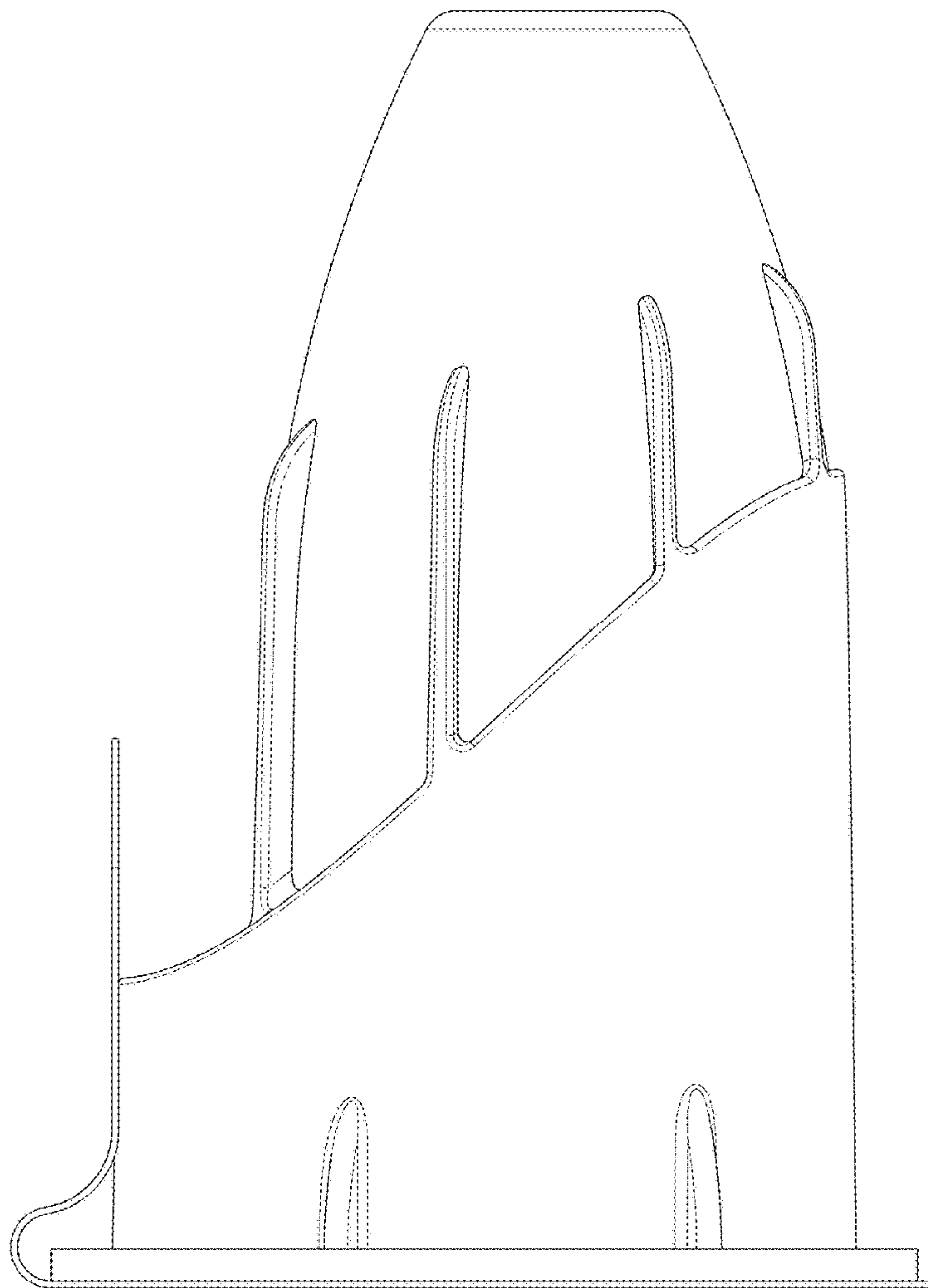

FIG. 6

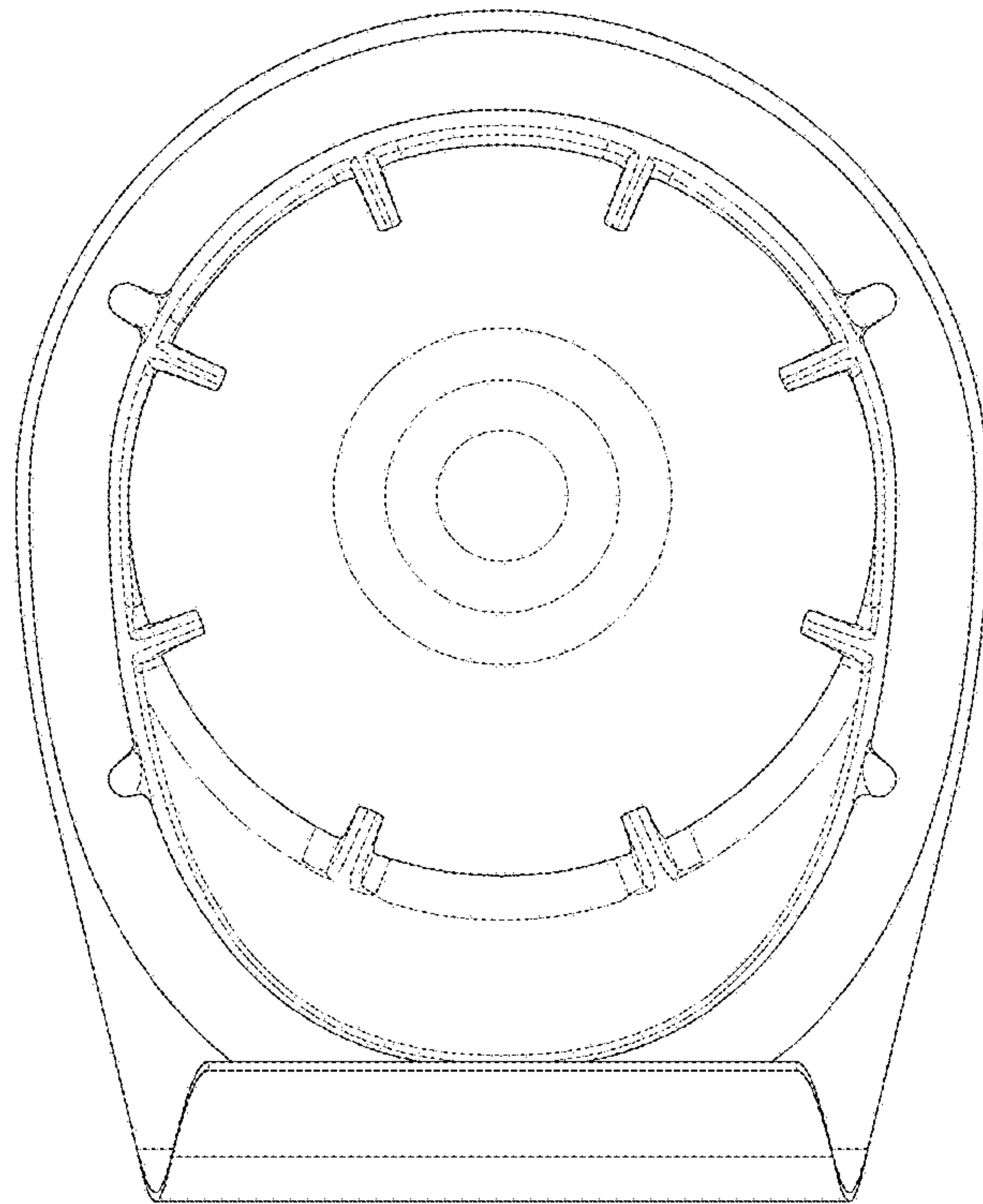

FIG. 7

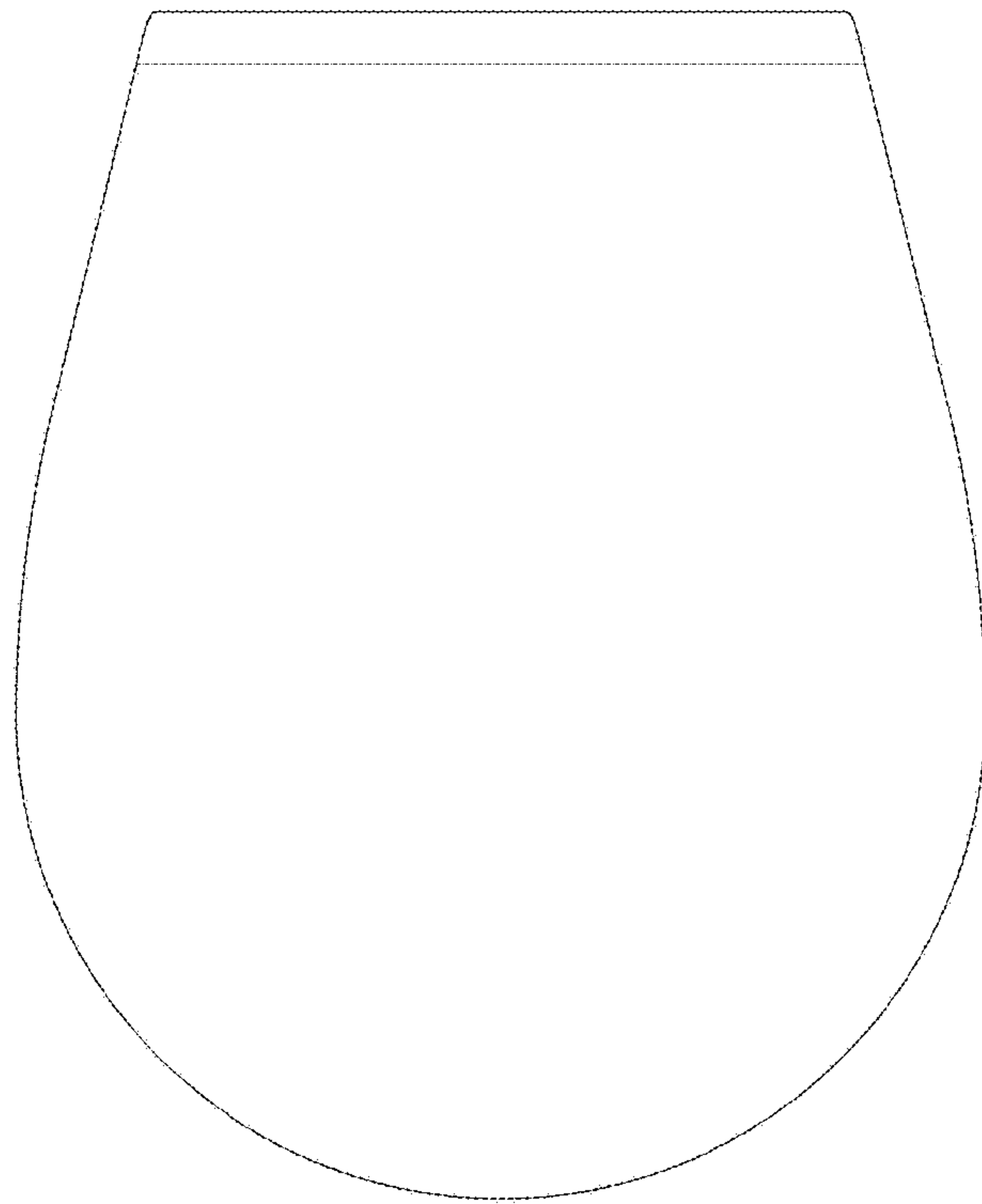

FIG. 8