



US00D847894S

(12) **United States Design Patent** (10) **Patent No.:** **US D847,894 S**  
**Li et al.** (45) **Date of Patent:** **\*\* May 7, 2019**

(54) **LIGHT SHIELD**

OTHER PUBLICATIONS

(71) Applicant: **SHENZHEN DLODLO NEW TECHNOLOGY CO., LTD.**,  
Shenzhen, Guangdong (CN)

(72) Inventors: **Gang Li**, Guangdong (CN); **Fengxue Zhang**, Guangdong (CN)

(73) Assignee: **SHENZHEN DLODLO NEW TECHNOLOGY CO., LTD.**,  
Shenzhen, Guangdong (CN)

(\*\*) Term: **15 Years**

(21) Appl. No.: **29/631,327**

(22) Filed: **Dec. 29, 2017**

(30) **Foreign Application Priority Data**

Jun. 30, 2017 (CN) ..... 2017 3 0283050

(51) **LOC (11) Cl.** ..... **16-06**

(52) **U.S. Cl.**  
USPC ..... **D16/313**

(58) **Field of Classification Search**  
USPC ..... D16/300, 313, 314, 321  
CPC ..... A61F 9/02; G02C 7/02  
See application file for complete search history.

(56) **References Cited**

U.S. PATENT DOCUMENTS

2,274,791 A \* 3/1942 Huggins ..... A61F 9/02  
2/13  
2,706,815 A \* 4/1955 Parmelee ..... A61F 9/02  
2/441  
D759,654 S \* 6/2016 Sullivan ..... D14/372  
D778,339 S \* 2/2017 Yoo ..... D16/313  
D806,073 S \* 12/2017 Li ..... D14/372  
D834,019 S \* 11/2018 Dallmeyer ..... D14/372

Arco panoweld goggles, posted at arco.co.uk, posting date not given, [online], [site visited Dec. 6, 2018]. Available from Internet, URL: <https://www.arco.co.uk/weldingeyeface#goggles> (Year: 2018).\*  
JSP Clipper Welding Goggle, posted at lawson-his.co.uk, posting date not given, [online], [site visited Dec. 6, 2018]. Available from Internet, URL: <https://www.lawson-his.co.uk/jsp-clipper-welding-goggle-moulded-panorama-type-sh5-1693> (Year: 2018).\*  
Panoramic welding goggles, posted at migtigarc.co.uk, posting date not given, [online], [site visited Dec. 6, 2018]. Available from Internet, URL: <https://migtigarc.co.uk/panoramic-welding-goggles-471-p.asp> (Year: 2018).\*  
Safety Welding Goggles with 4 Valves, posted at globalsources.com, posting date not given, [online], [site visited Dec. 6, 2018]. Available from Internet, URL: <https://www.globalsources.com/gsol/1/Safety-goggle/p/sm/1053555172.htm#1053555172> (Year: 2018).\*

\* cited by examiner

*Primary Examiner* — George D. Kirschbaum

*Assistant Examiner* — Maria J Edwards

(74) *Attorney, Agent, or Firm* — Apex Attorneys at Law, LLP; Yue (Robert) Xu

(57) **CLAIM**

The ornamental design for a light shield, as shown and described.

**DESCRIPTION**

FIG. 1 is a front view of a light shield, showing our new design;  
FIG. 2 is a rear view thereof;  
FIG. 3 is a left view thereof;  
FIG. 4 is a right view thereof;  
FIG. 5 is a top view thereof;  
FIG. 6 is a bottom thereof; and,  
FIG. 7 is a perspective view thereof.

**1 Claim, 7 Drawing Sheets**

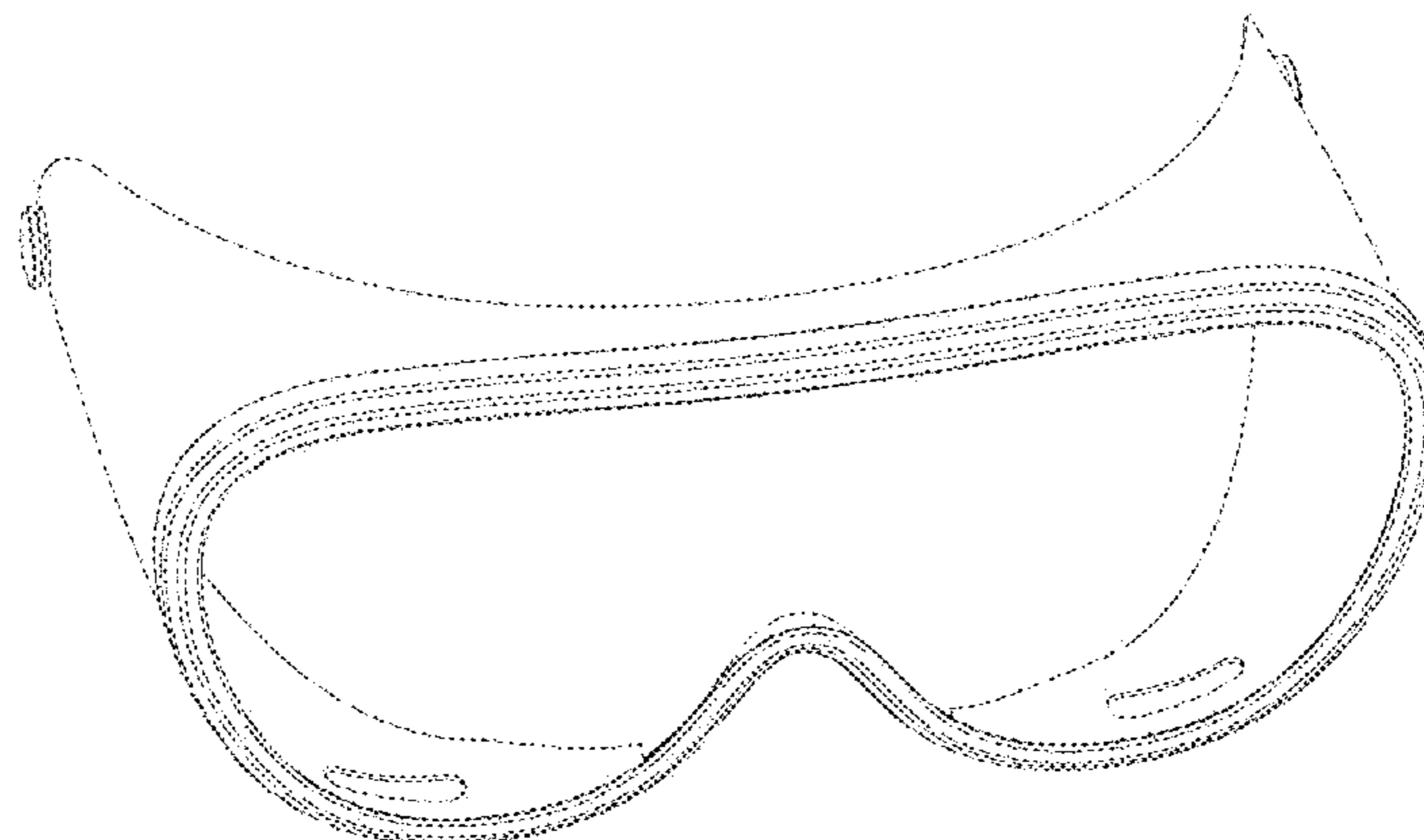

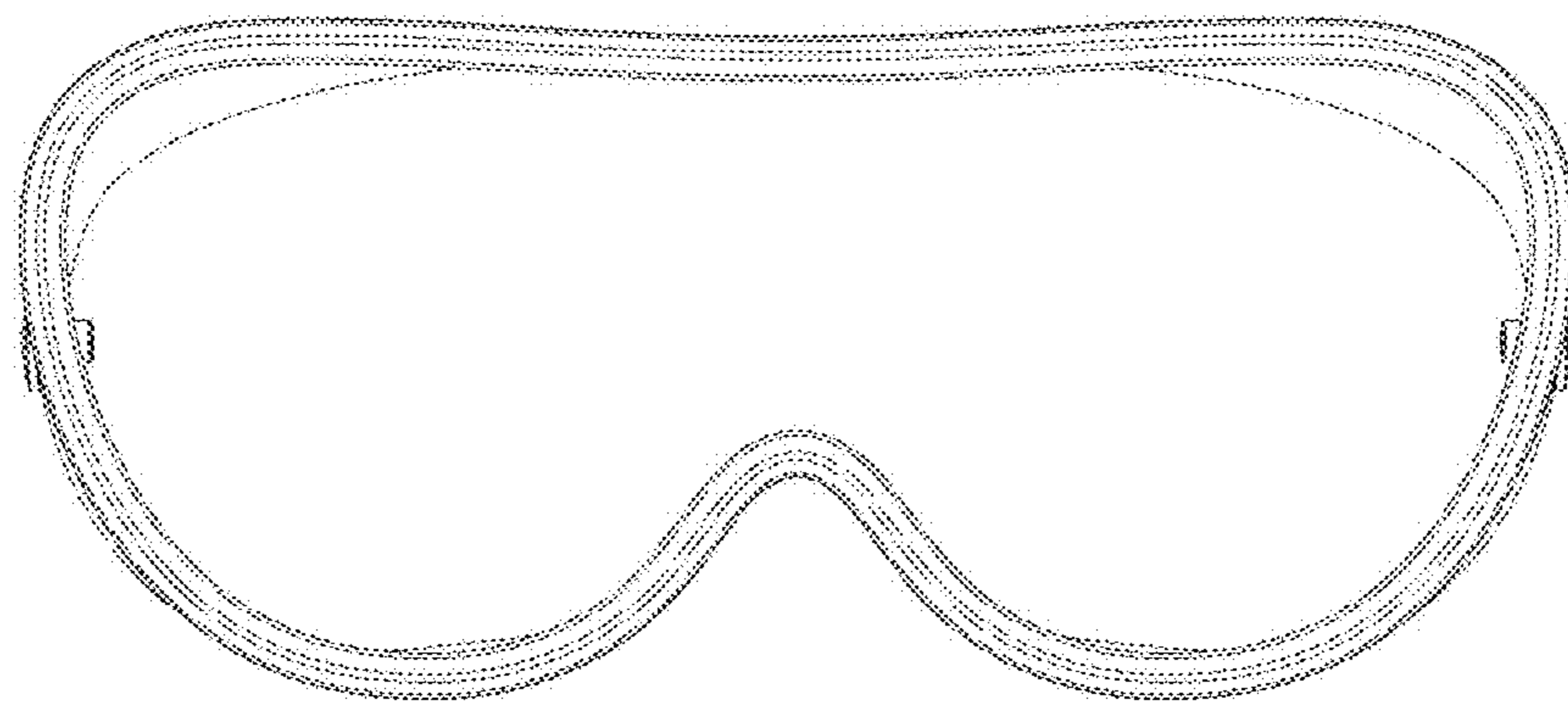

**FIG. 1**

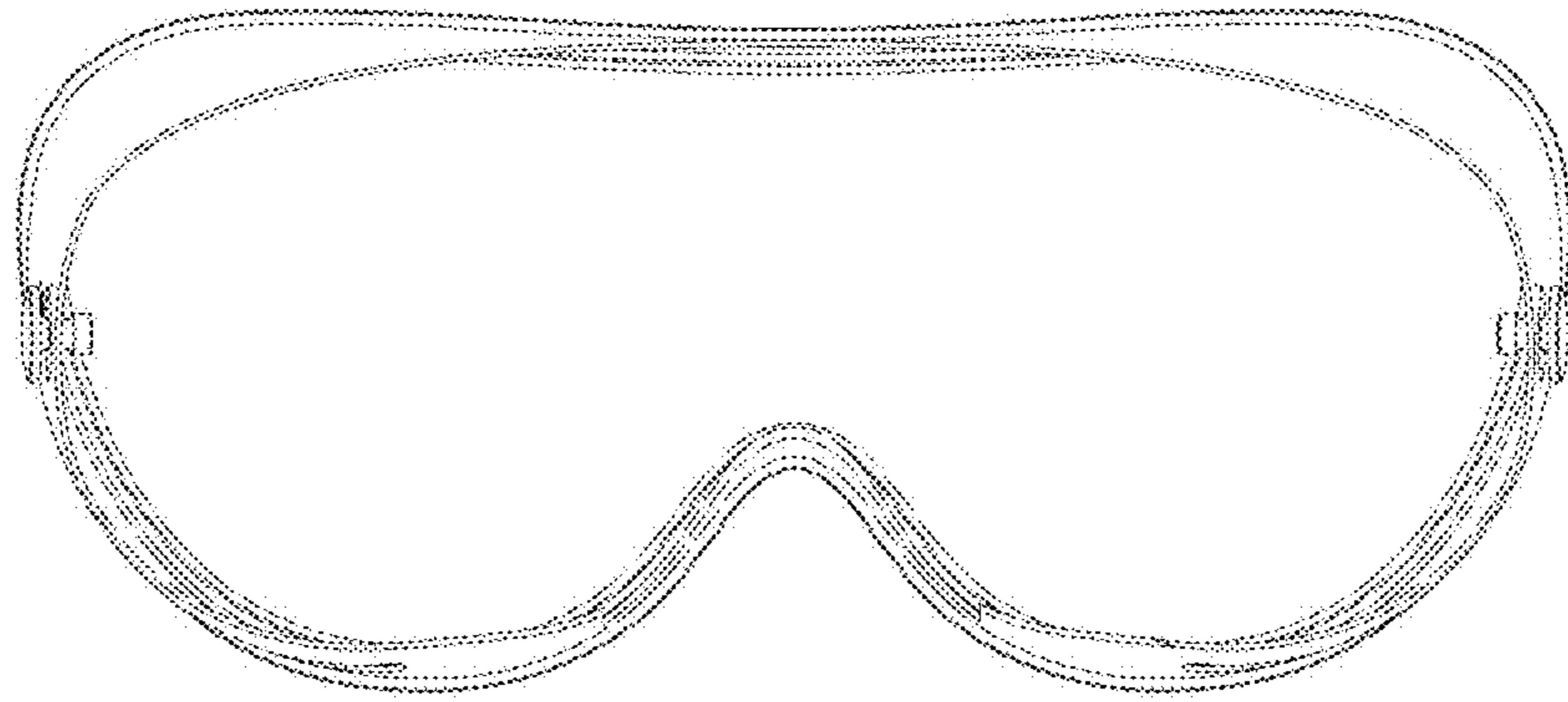

FIG. 2

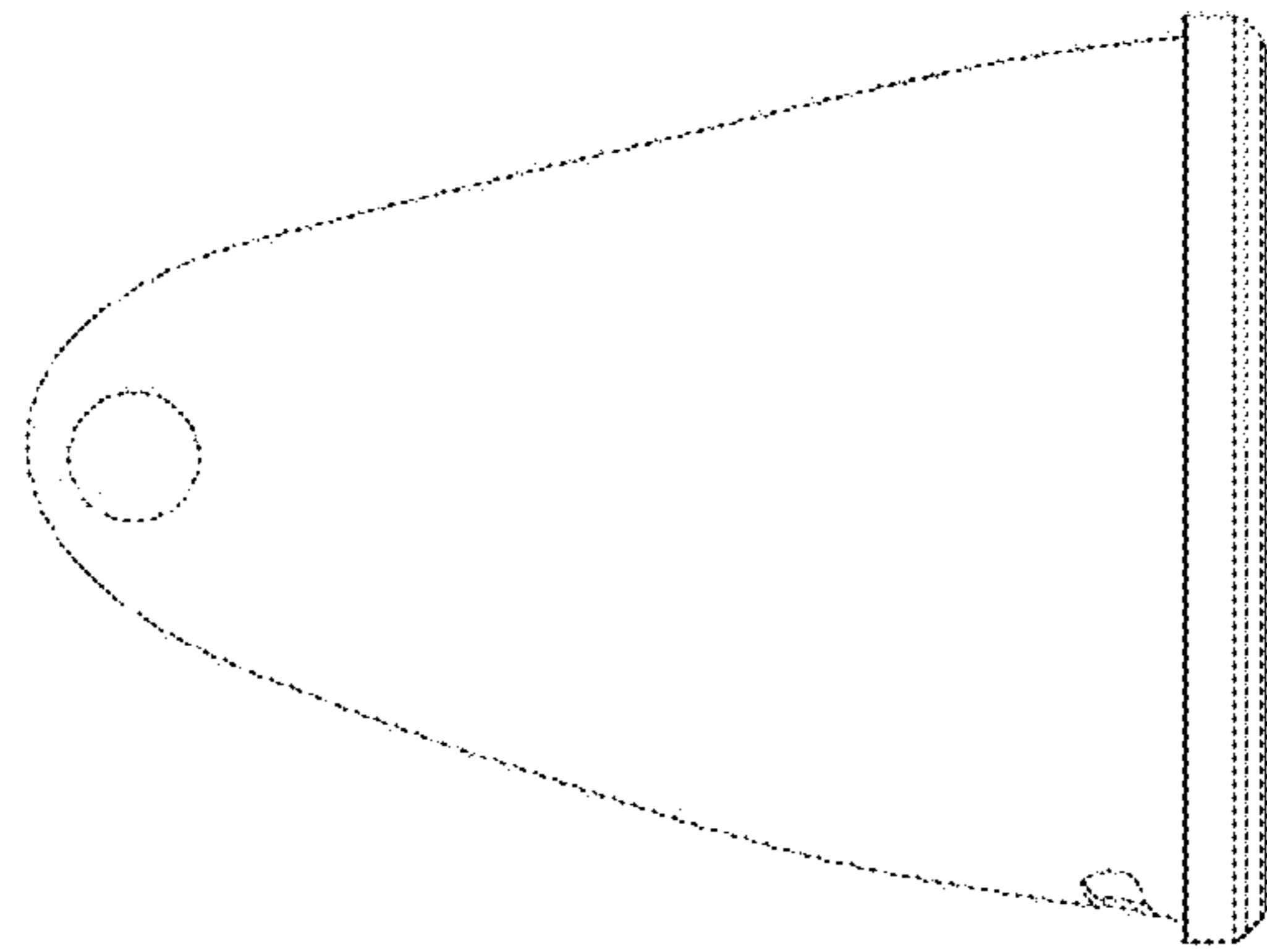

FIG. 3

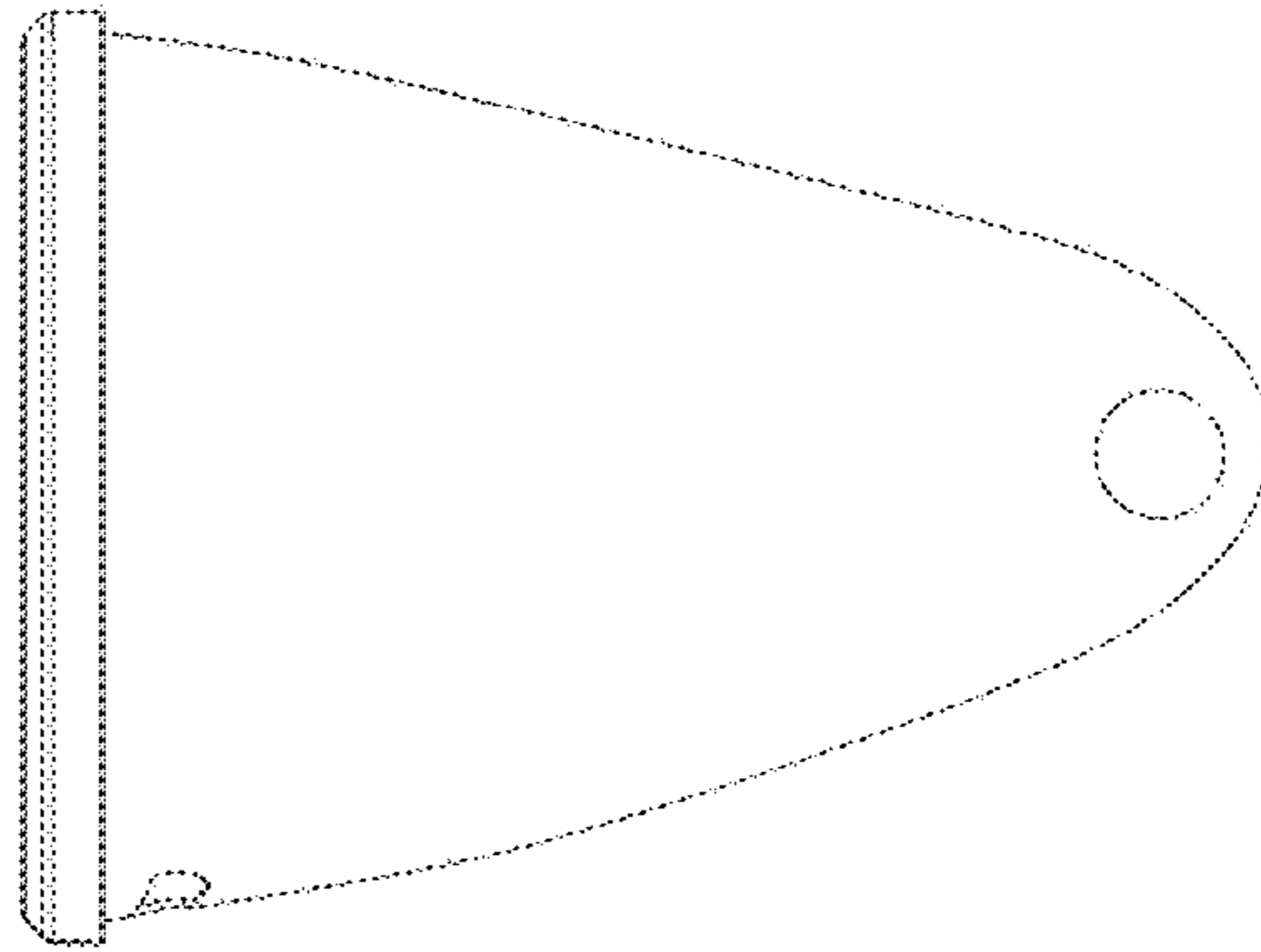

FIG. 4

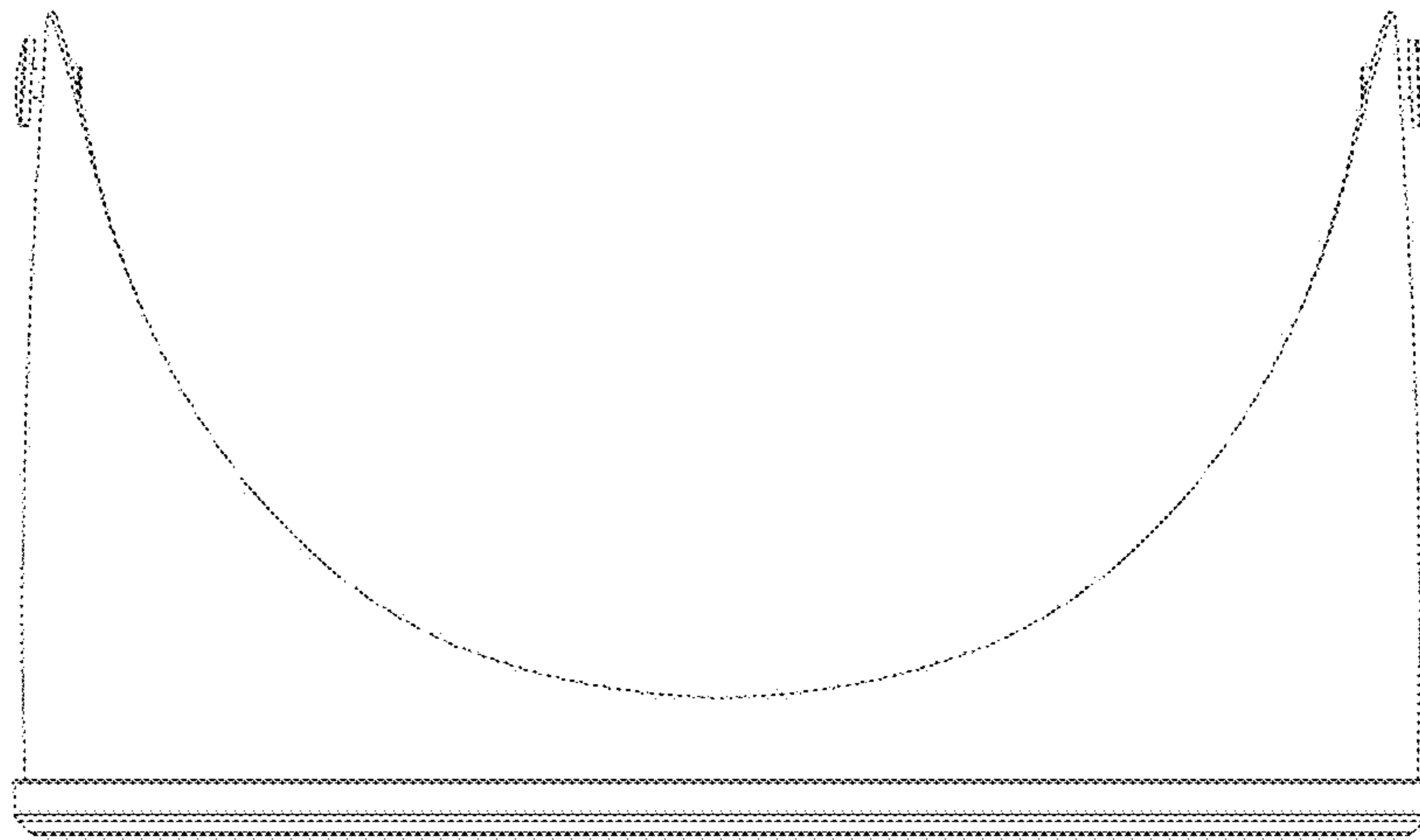

FIG. 5

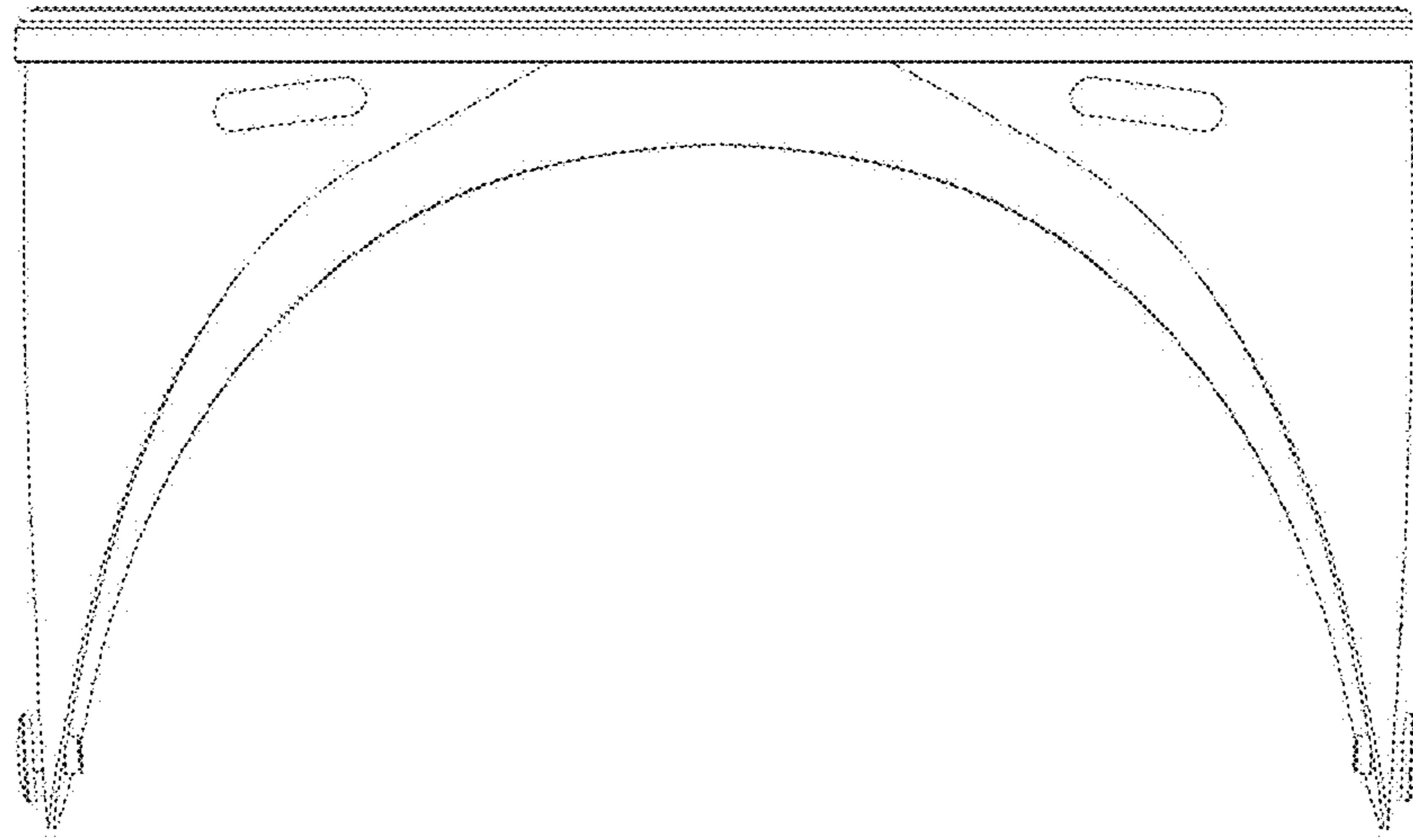

FIG. 6

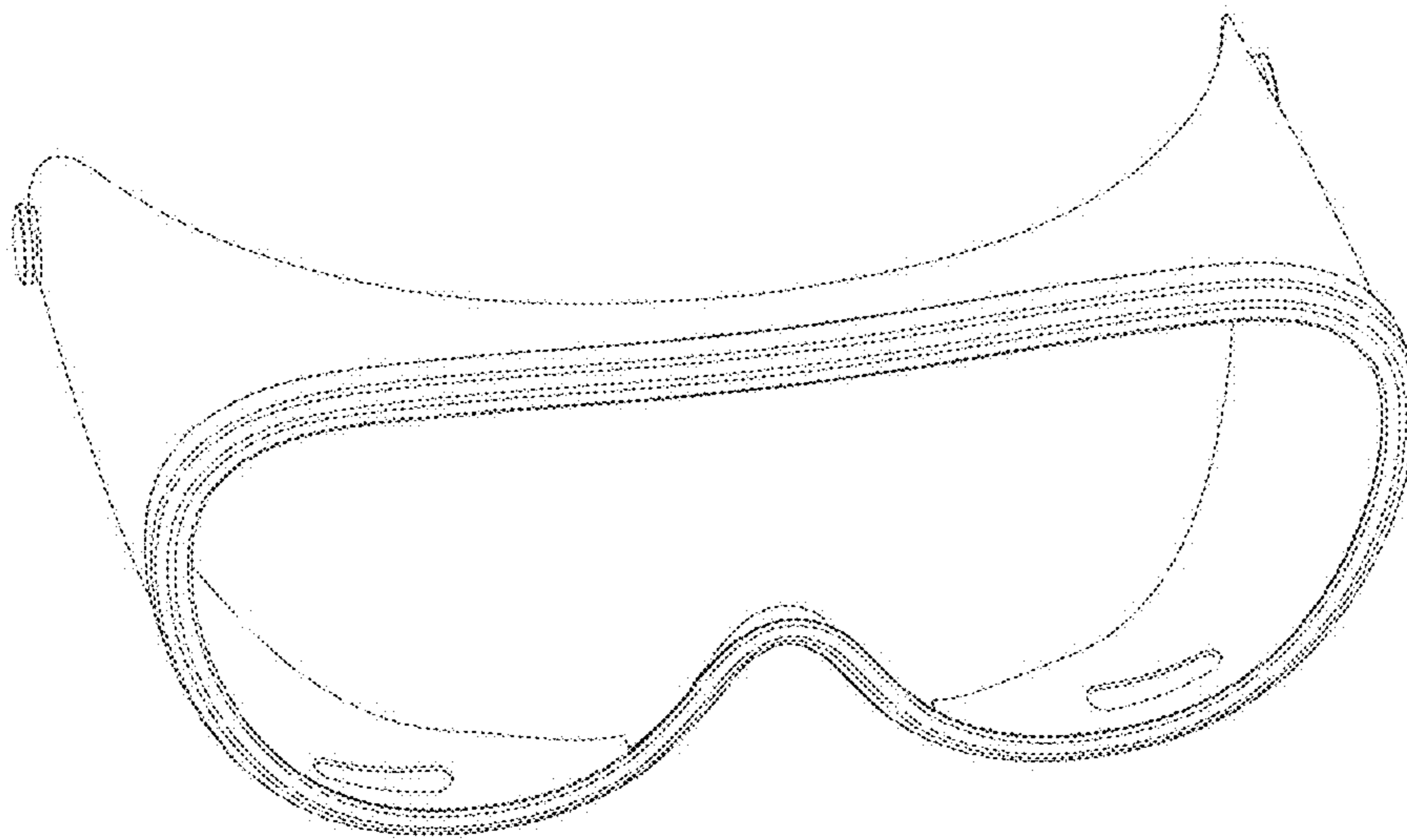

FIG. 7