



US00D847497S

(12) **United States Design Patent** (10) **Patent No.:** **US D847,497 S**
Cooke et al. (45) **Date of Patent:** **** May 7, 2019**

(54) **HANDBAG**

D742,635 S * 11/2015 Coleman D3/232
D811,732 S * 3/2018 Barclay et al. D3/232
D811,733 S * 3/2018 Barclay et al. D3/232

(71) Applicant: **THE BIG O, LLC**, Dallas, TX (US)

* cited by examiner

(72) Inventors: **Jane Dunne Cooke**, Dallas, TX (US);
Mary Caroline Nix, Dallas, TX (US)

Primary Examiner — Holly H Baynham

(73) Assignee: **THE BIG O, LLC**, Dallas, TX (US)

(74) *Attorney, Agent, or Firm* — Haynes and Boone, LLP

(**) Term: **15 Years**

(57) **CLAIM**

The ornamental design for a handbag, as shown and described.

(21) Appl. No.: **29/632,812**

DESCRIPTION

(22) Filed: **Jan. 10, 2018**

This application is related to U.S. patent application Ser. No. 29/632,809, filed Jan. 10, 2018 bearing the entire disclosure of which is hereby incorporated herein by reference.

(51) **LOC (11) Cl.** **03-01**

(52) **U.S. Cl.**
USPC **D3/232**

FIG. 1 is a perspective view of a handbag showing our new design;

(58) **Field of Classification Search**
USPC D3/232–233, 240–243, 245–246
CPC A45C 1/024; A45C 3/06
See application file for complete search history.

FIG. 2 is a front elevational view thereof;

FIG. 3 is a rear elevational view thereof;

FIG. 4 is a right side elevational view thereof;

FIG. 5 is a left side elevational view thereof;

FIG. 6 is a top plan view thereof;

FIG. 7 is a bottom plan view thereof;

FIG. 8 is another perspective view thereof; and,

FIG. 9 is yet another perspective view thereof.

(56) **References Cited**

U.S. PATENT DOCUMENTS

D621,610 S * 8/2010 Parsley D3/232
D693,117 S * 11/2013 Maier D3/232

1 Claim, 7 Drawing Sheets

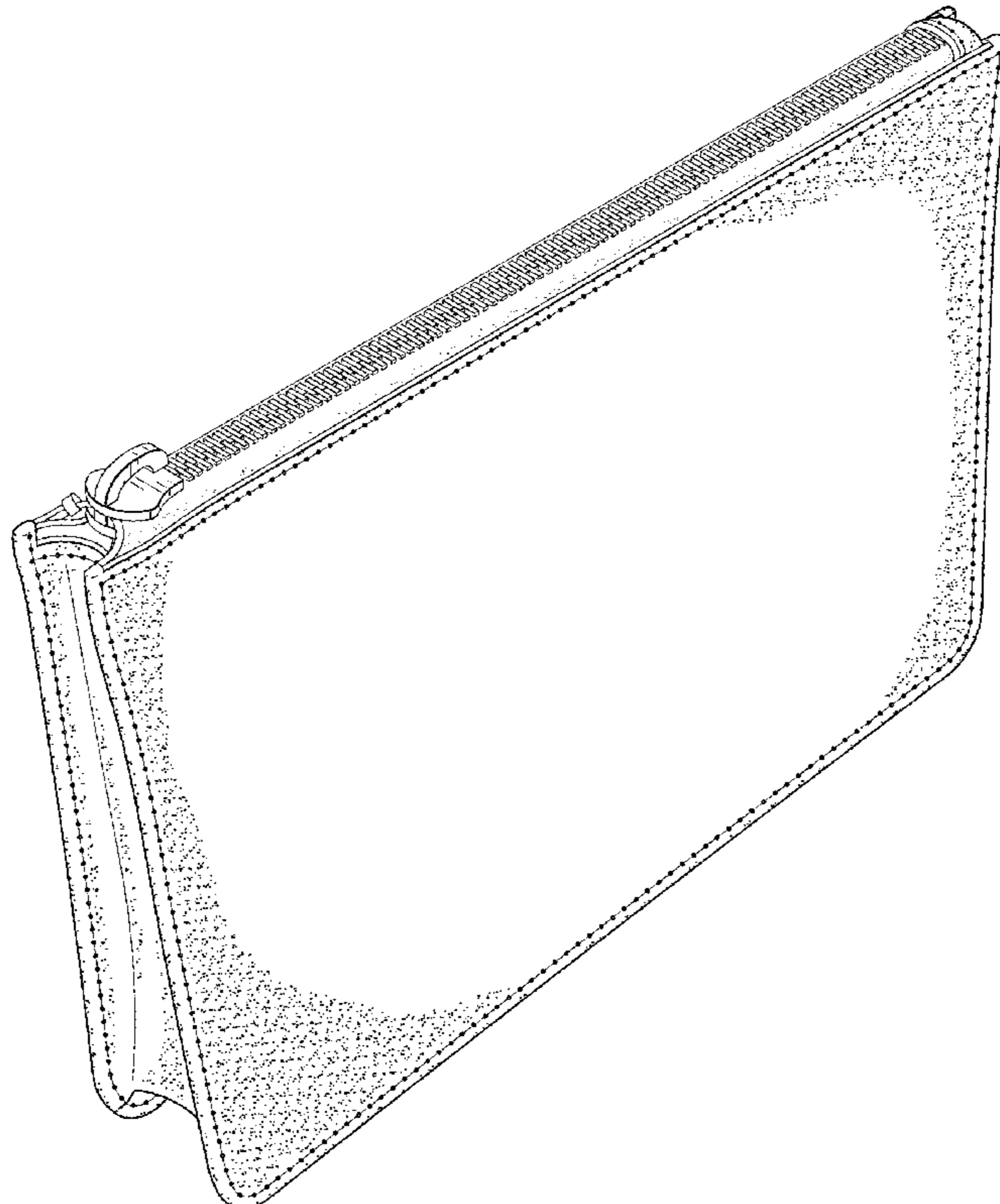

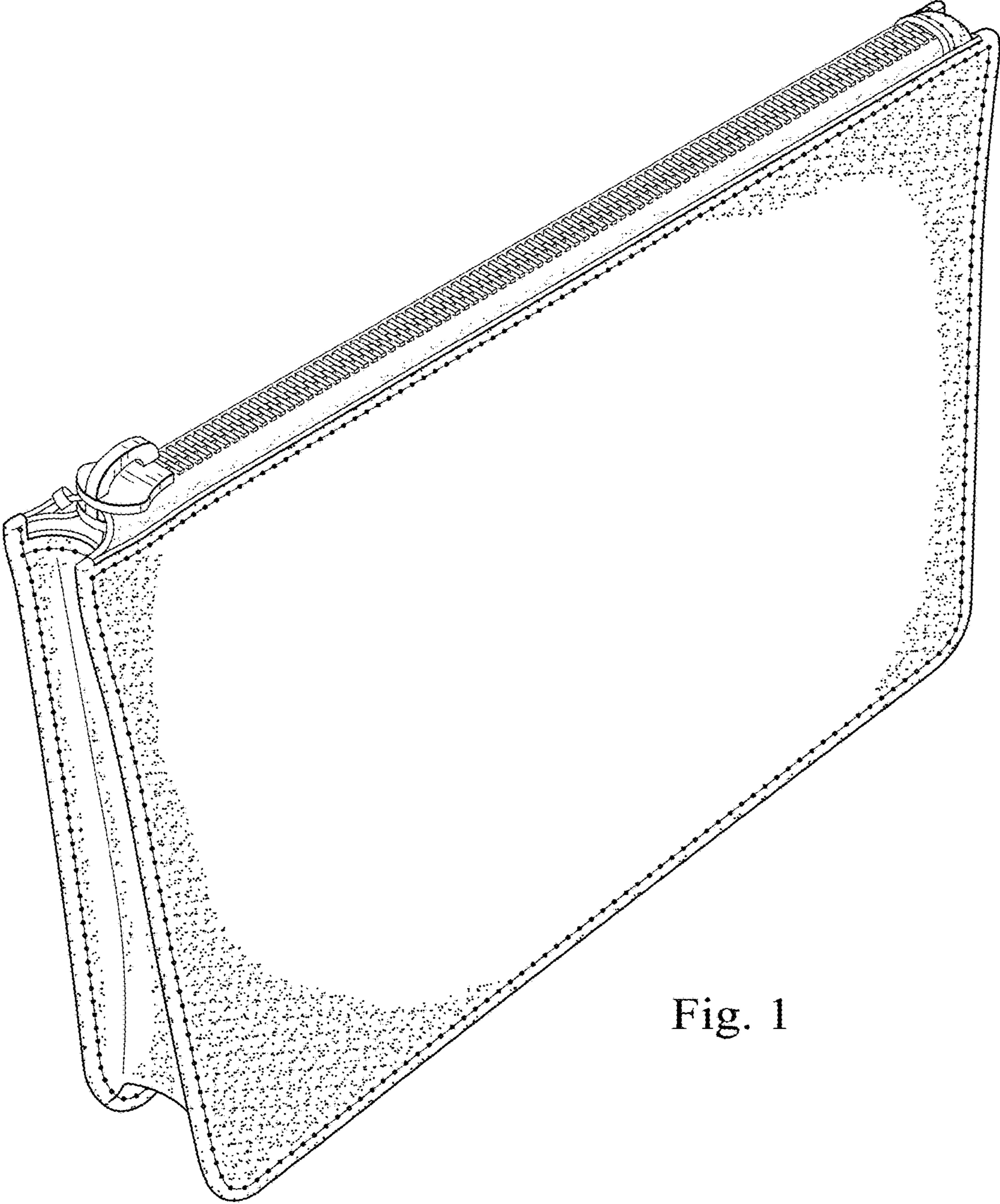

Fig. 1

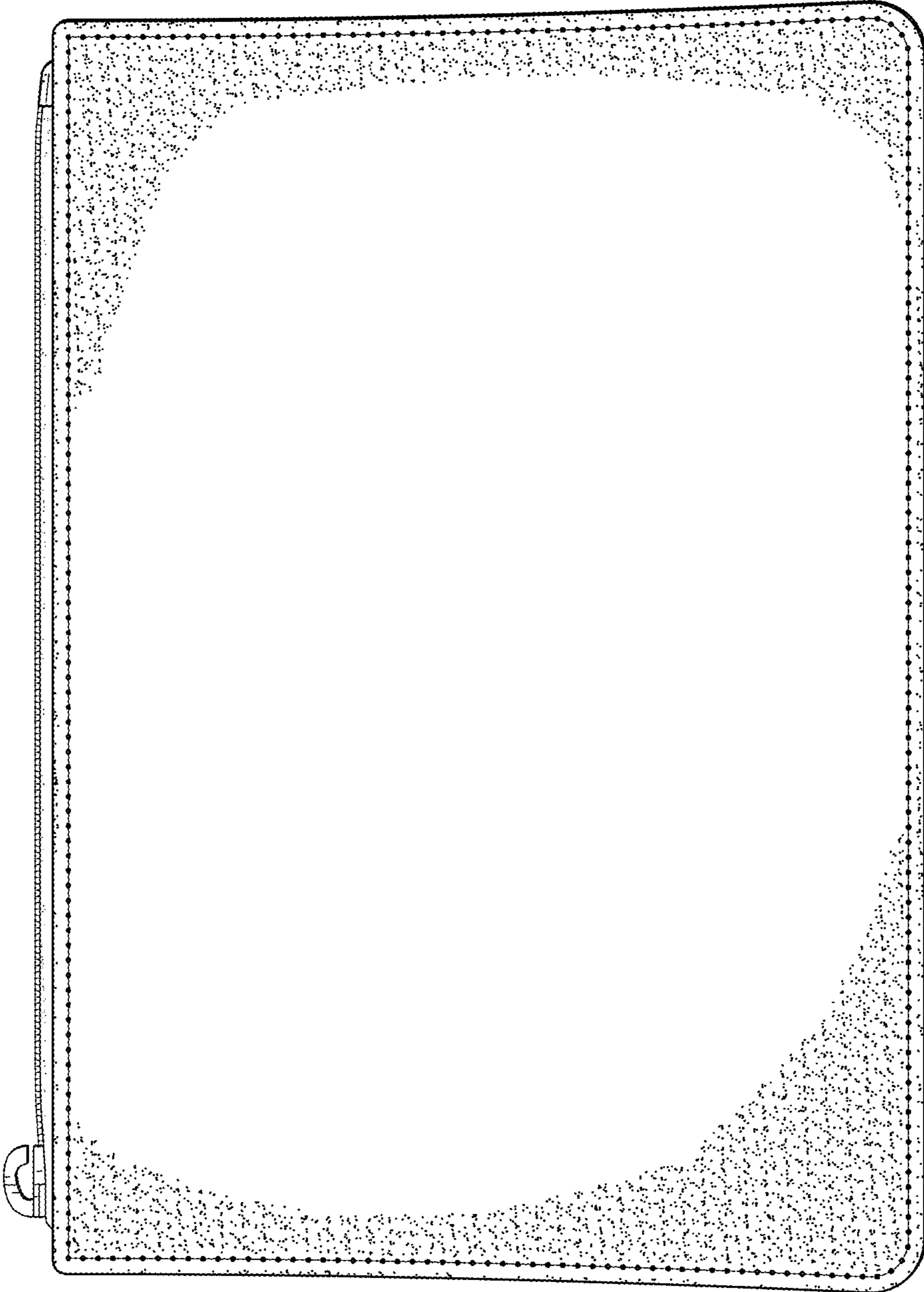

Fig. 2

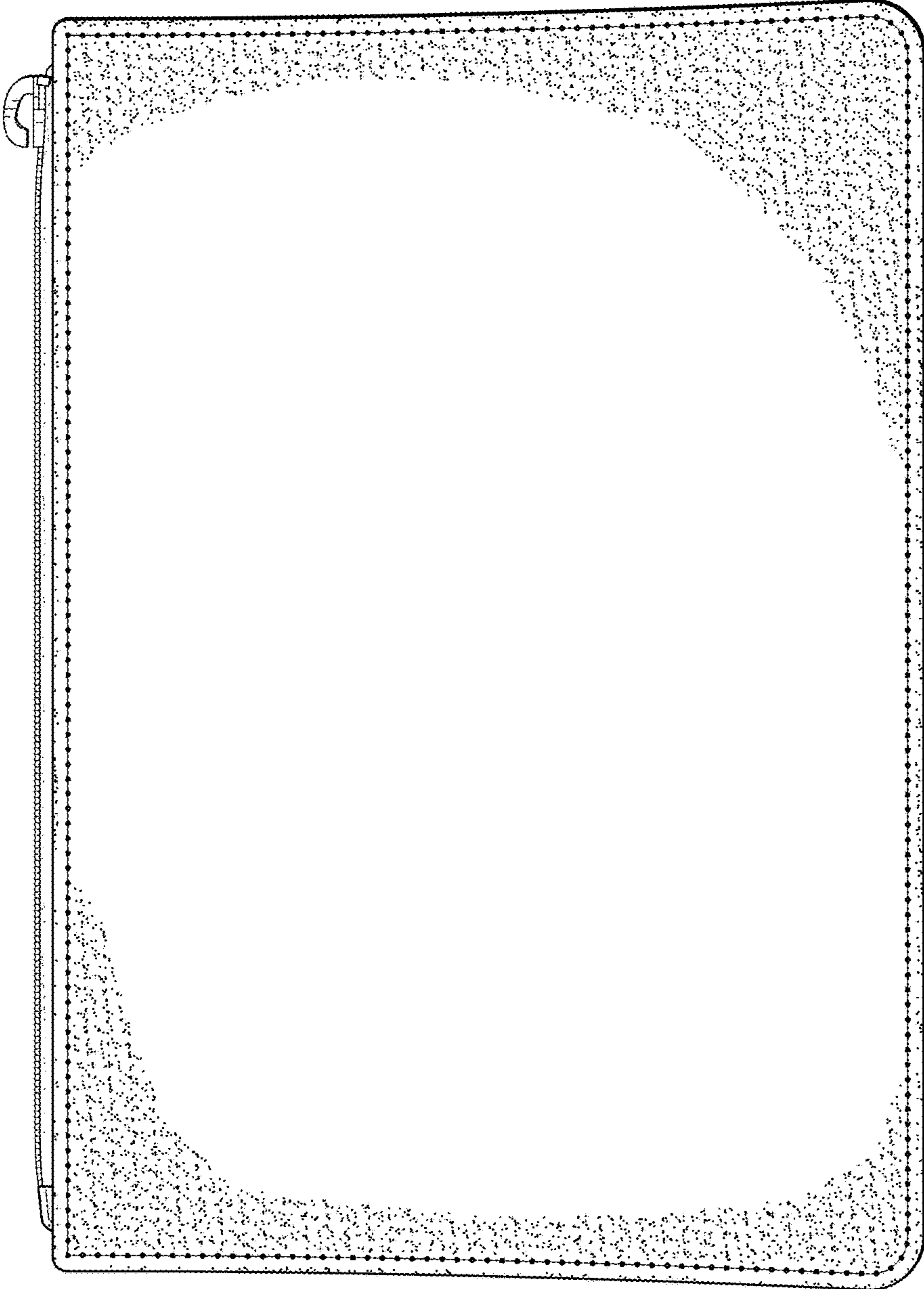

Fig. 3

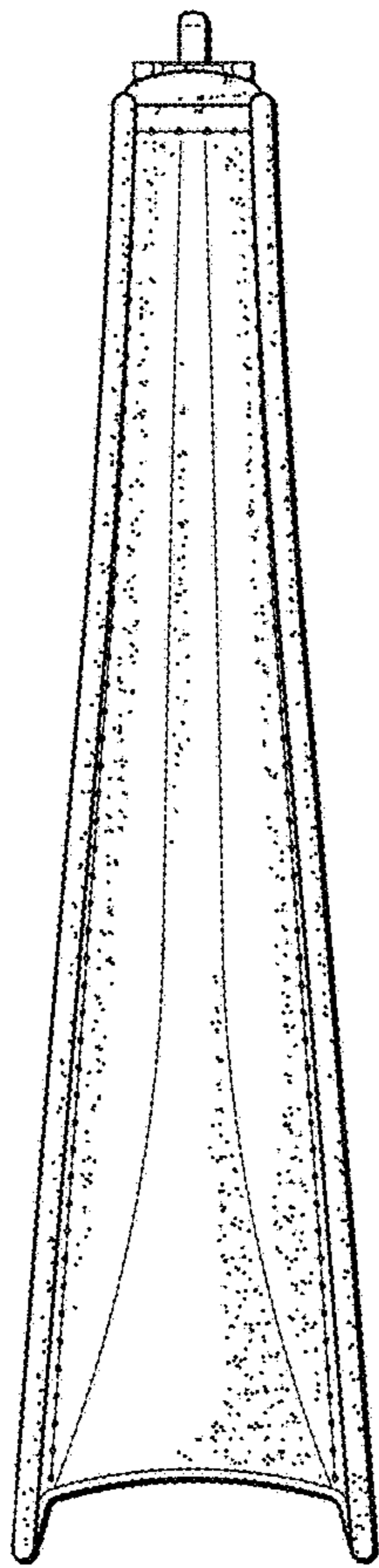

Fig. 4

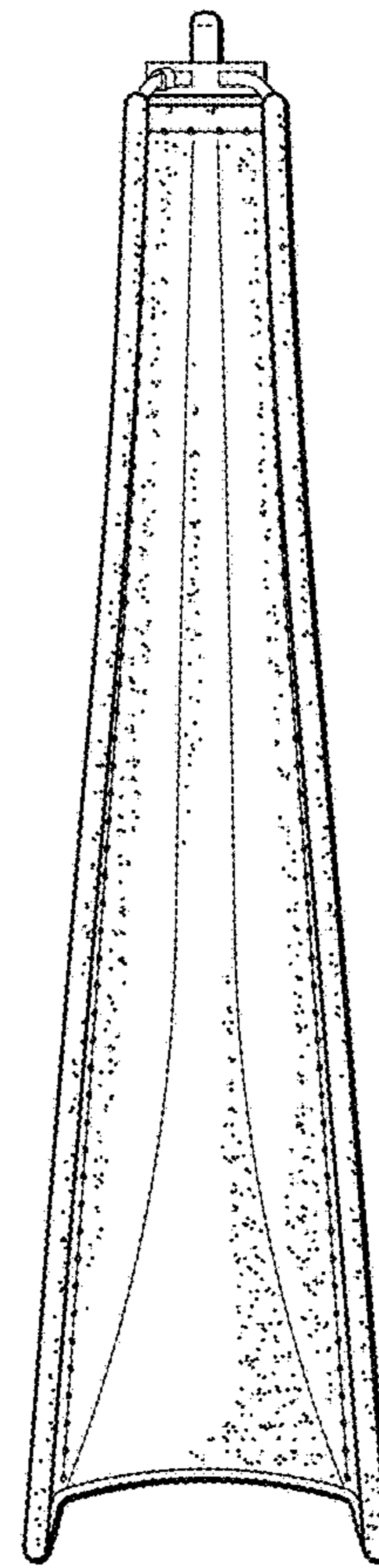

Fig. 5

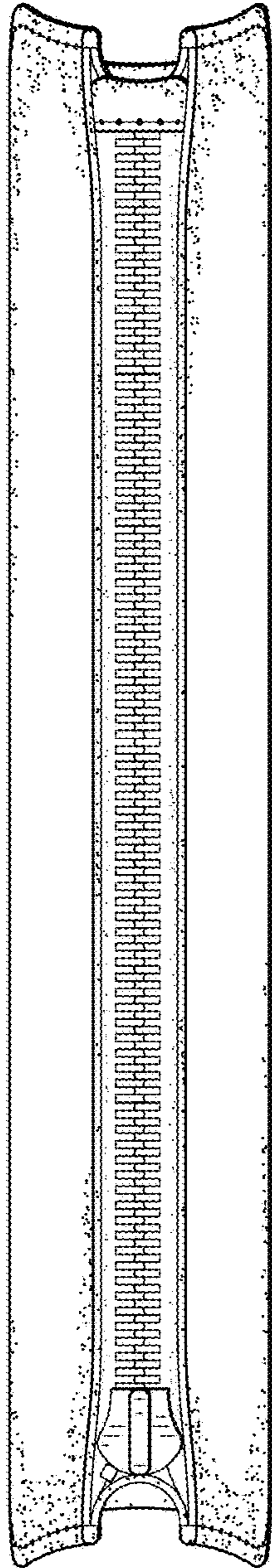

Fig. 6

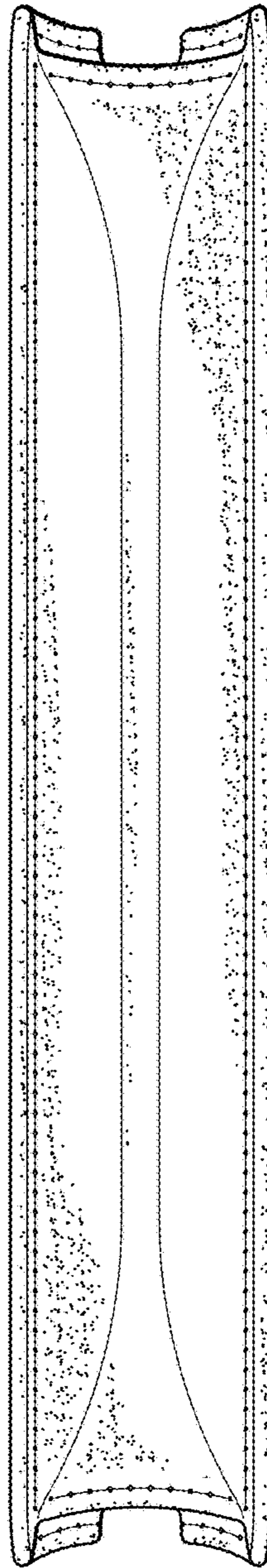

Fig. 7

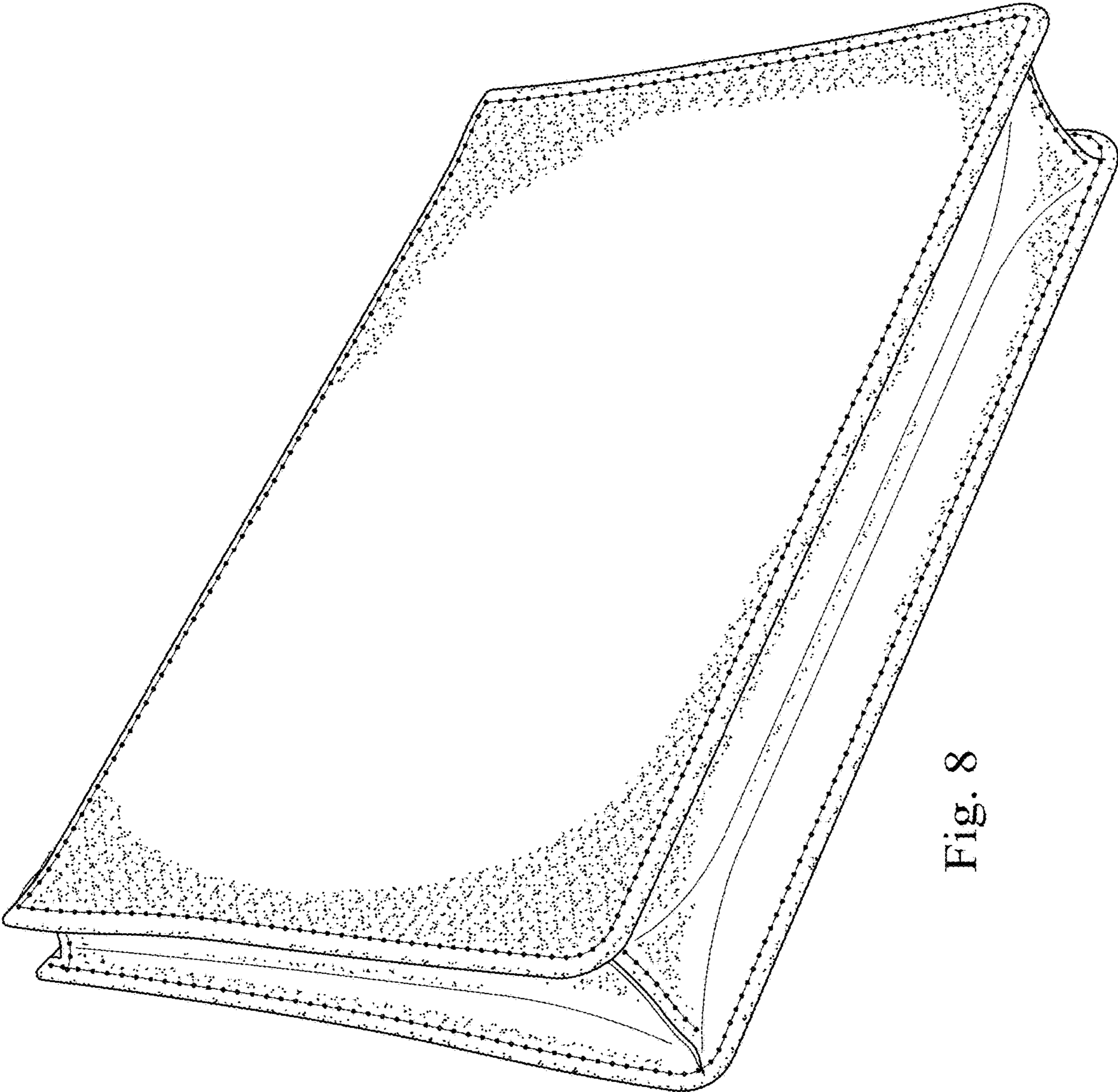

Fig. 8

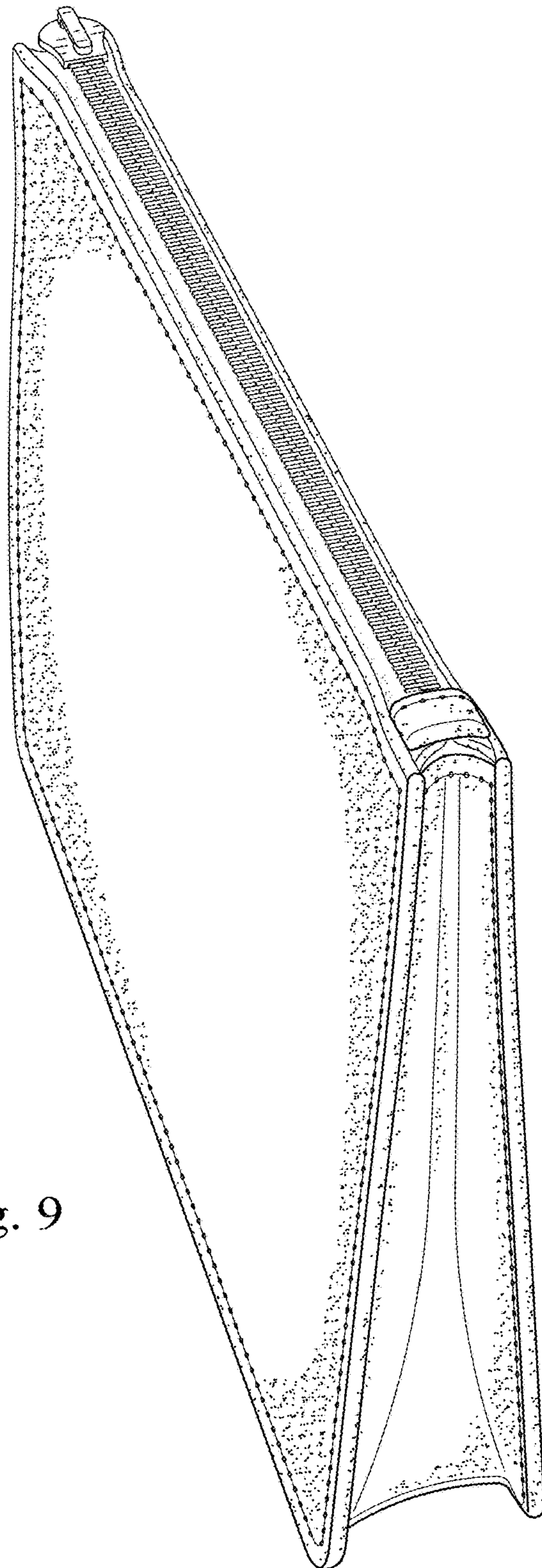

Fig. 9

UNITED STATES PATENT AND TRADEMARK OFFICE
CERTIFICATE OF CORRECTION

PATENT NO. : D847,497 S
APPLICATION NO. : 29/632812
DATED : May 7, 2019
INVENTOR(S) : Jane Dunne Cooke and Mary Caroline Nix

Page 1 of 1

It is certified that error appears in the above-identified patent and that said Letters Patent is hereby corrected as shown below:

On the Title Page

Item (57), under the Description, please replace the sentence:

“This application is related to U.S. patent application Ser. No. 29/632,809, filed January 10, 2018 bearing, the entire disclosure of which is hereby incorporated herein by reference.”

With the following section:

-- Cross-Reference to Related Applications

This application is related to U.S. Patent Application No. 29/632,809, filed January 10, 2018 bearing Attorney Docket No. 52815.26US01, the entire disclosure of which is hereby incorporated herein by reference.

This application is related to U.S. Patent Application No. 62/615,611, filed January 10, 2018 bearing Attorney Docket No. 52815.28PV01, the entire disclosure of which is hereby incorporated herein by reference. --

Signed and Sealed this
Twentieth Day of August, 2019

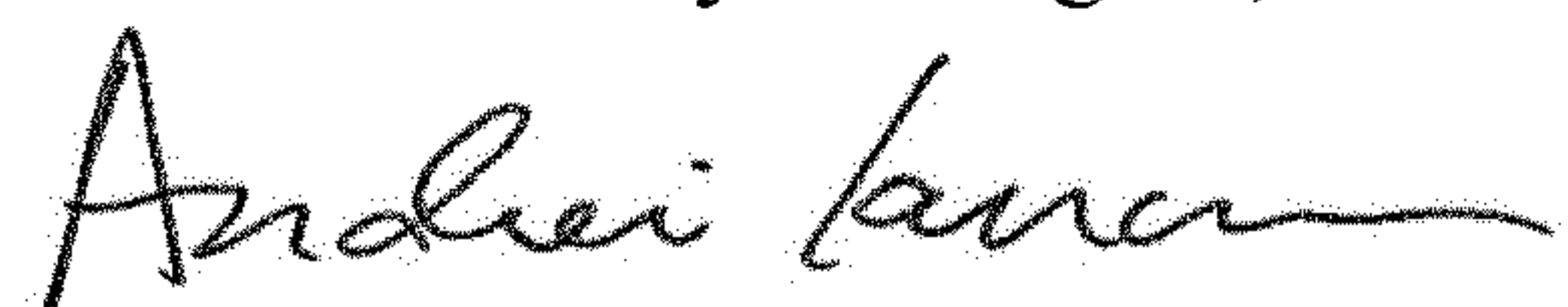

Andrei Iancu
Director of the United States Patent and Trademark Office