



US00D847450S

(12) **United States Design Patent**  
**Norton**

(10) **Patent No.:** **US D847,450 S**

(45) **Date of Patent:** **\*\* Apr. 30, 2019**

- (54) **TOP PLATE**
- (71) Applicant: **Cleveland Reclaim Industries, Inc.**,  
Lorain, OH (US)
- (72) Inventor: **Tom Norton**, Bay Village, OH (US)
- (73) Assignee: **Cleveland Reclaim Industries**, Lorain,  
OH (US)
- (\*\*) Term: **15 Years**
- (21) Appl. No.: **29/626,844**
- (22) Filed: **Nov. 21, 2017**

**Related U.S. Application Data**

- (63) Continuation of application No. 29/526,727, filed on  
May 13, 2015, now Pat. No. Des. 804,768.
- (51) **LOC (11) Cl.** ..... **12-05**
- (52) **U.S. Cl.**  
USPC ..... **D34/35**
- (58) **Field of Classification Search**  
USPC ..... D34/35, 38; 108/51.11, 52.1, 53.1, 55.1,  
108/55.3, 55.5, 57.13, 53.3, 53.5, 56.1,  
108/57.14, 57.16, 901, 57.25, 54.1, 57.28;  
206/506, 507, 509, 386, 597, 599, 600,  
206/497, 598, 453, 586, 521, 593, 594;  
53/589, 397, 447, 544, 590, 441, 461,  
53/556, 567, 399  
CPC ..... B65D 2519/00318; B65D 2519/00567;  
B65D 2519/00104; B65D 2519/00268;  
B65D 2519/00139; B65D 2519/00208;  
B65D 2519/00358  
See application file for complete search history.

(56) **References Cited**

**U.S. PATENT DOCUMENTS**

- 4,771,885 A \* 9/1988 Linnemann ..... B65D 5/68  
206/386
- 4,838,419 A \* 6/1989 Weits ..... B65D 71/70  
206/386

- 4,897,980 A \* 2/1990 Geysler ..... B65B 5/028  
53/128.1
- 4,976,365 A \* 12/1990 Seo ..... B65D 88/129  
108/55.1
- 4,989,731 A \* 2/1991 Shuert ..... B65D 15/22  
108/55.1
- D349,798 S \* 8/1994 Hude ..... D34/28
- 5,390,789 A \* 2/1995 Darby ..... B65D 19/44  
206/391
- 5,463,843 A \* 11/1995 Sharp ..... B65B 11/006  
53/399
- 5,927,211 A \* 7/1999 Giasi ..... B65D 19/0028  
108/51.3
- D531,027 S \* 10/2006 Ramirez ..... D9/435
- 9,327,873 B2 \* 5/2016 Frankenberg ..... B65D 19/38
- D804,768 S \* 12/2017 Norton ..... D34/35
- 2006/0081490 A1 \* 4/2006 Bradford ..... B65D 19/18  
206/386

\* cited by examiner

*Primary Examiner* — Cynthia Ramirez

*Assistant Examiner* — Gino Colan

(74) *Attorney, Agent, or Firm* — Calfee, Halter &  
Griswold, LLP

(57) **CLAIM**

I claim the ornamental design for a top plate, as shown and  
described.

**DESCRIPTION**

FIG. 1 is a front, left, top perspective view of a top plate  
showing my new design;  
FIG. 2 is a rear, right, bottom perspective view thereof;  
FIG. 3 is a front elevational view thereof;  
FIG. 4 is a rear elevational view thereof;  
FIG. 5 is a left side elevational view thereof;  
FIG. 6 is a right side elevational view thereof;  
FIG. 7 is a top plan view thereof; and,  
FIG. 8 is a bottom plan view thereof.

**1 Claim, 5 Drawing Sheets**

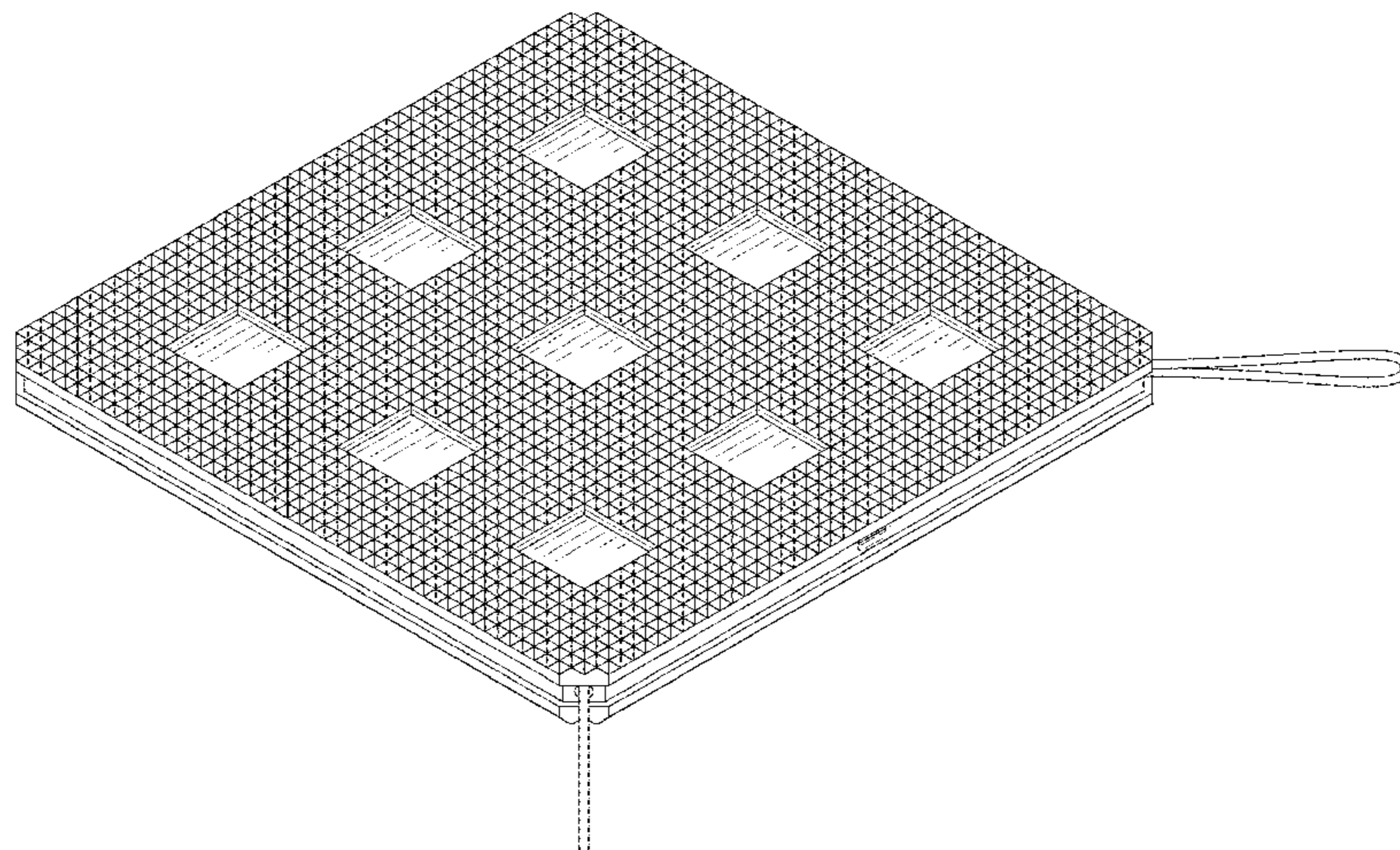



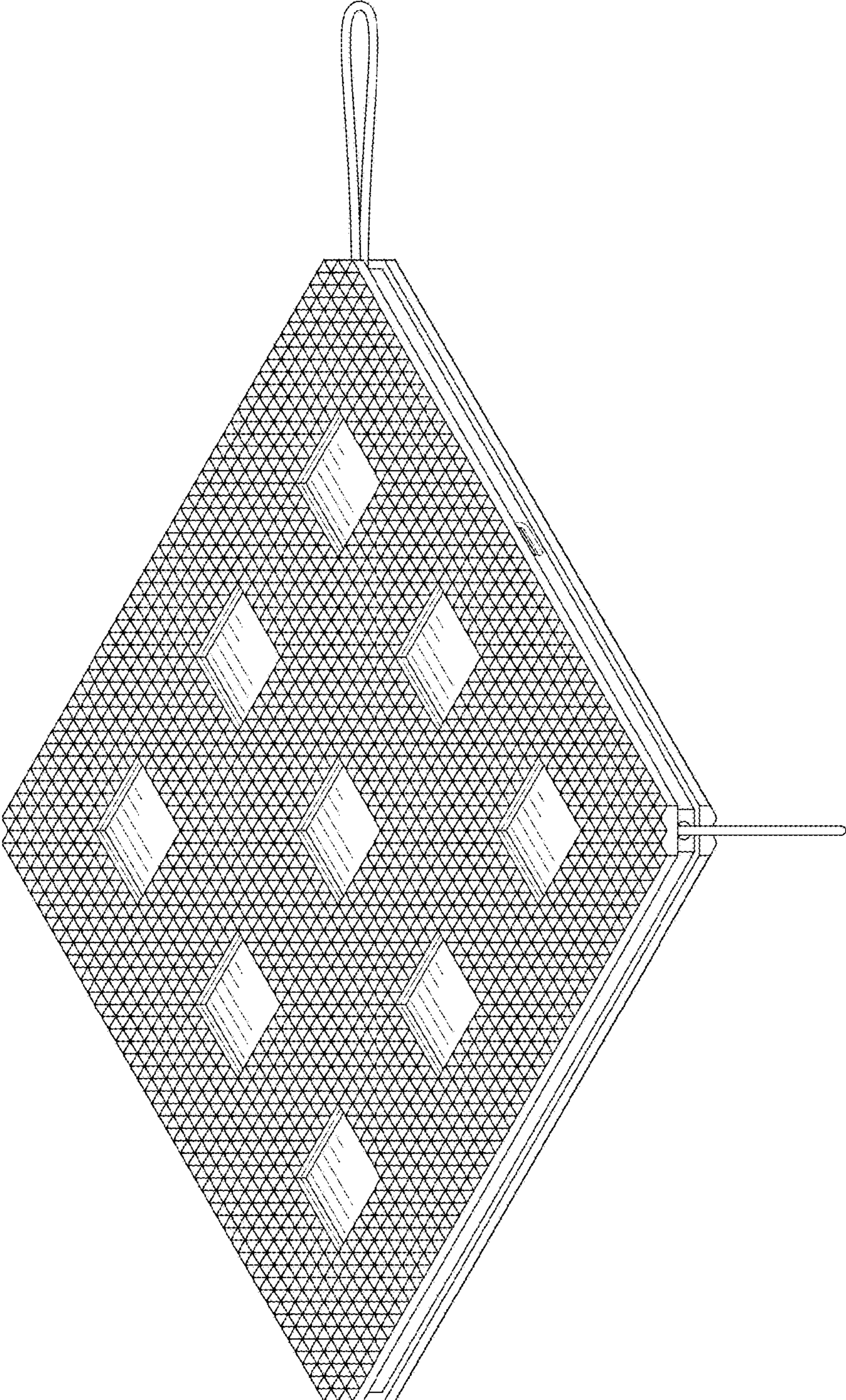

FIG. 1



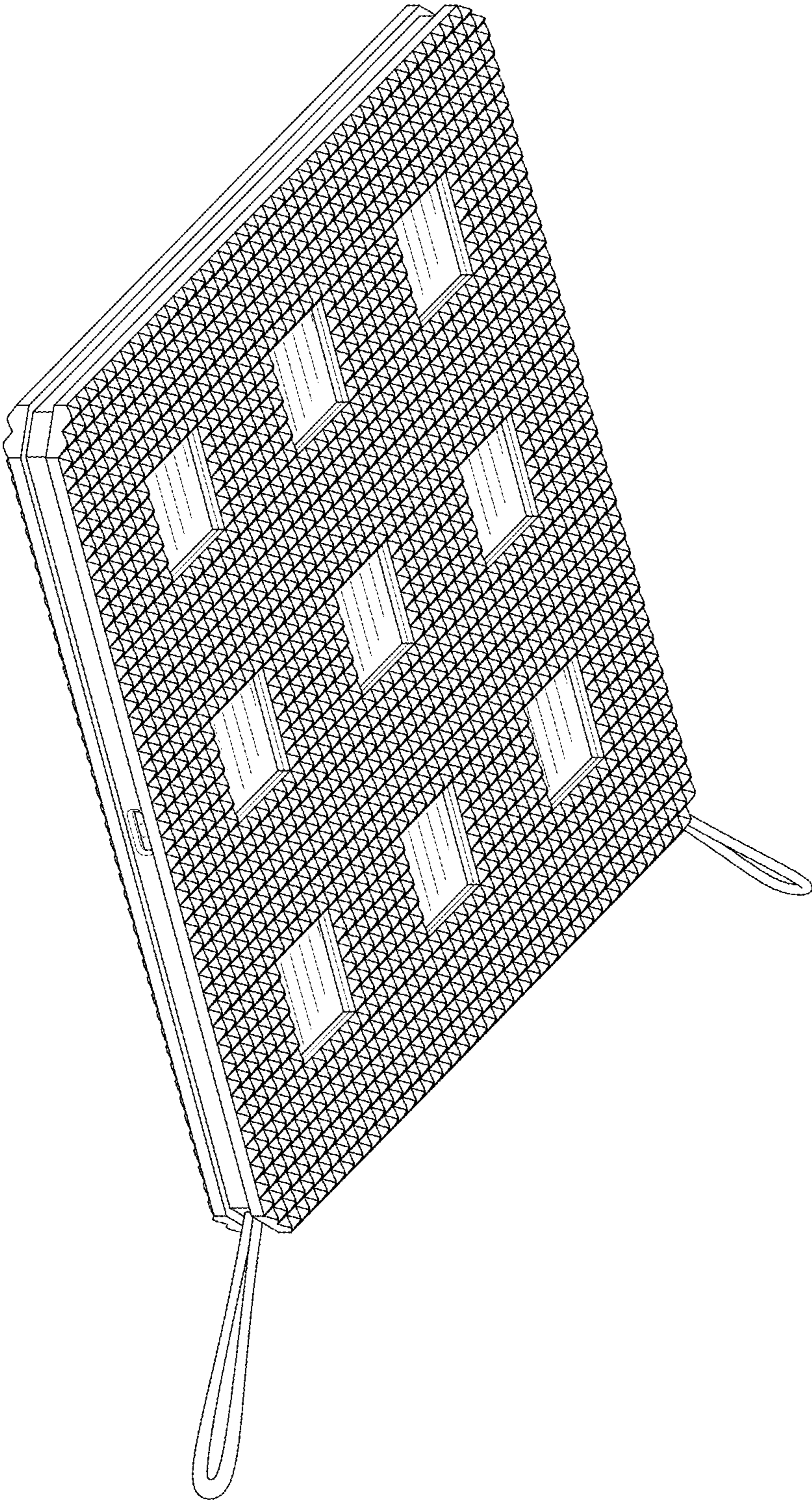

FIG. 2

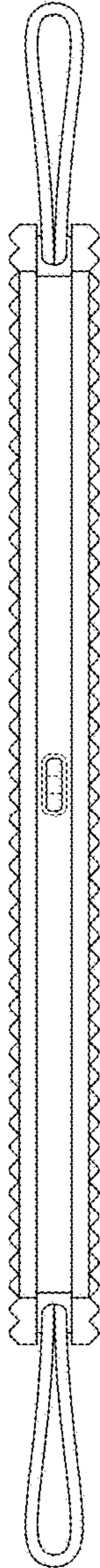

FIG. 3

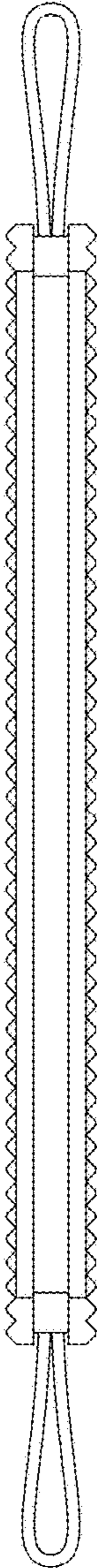

FIG. 4

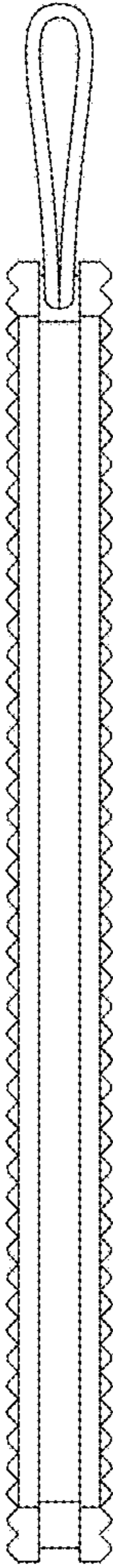

FIG. 5

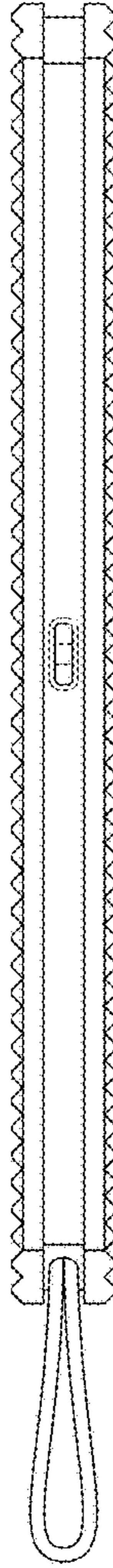

FIG. 6



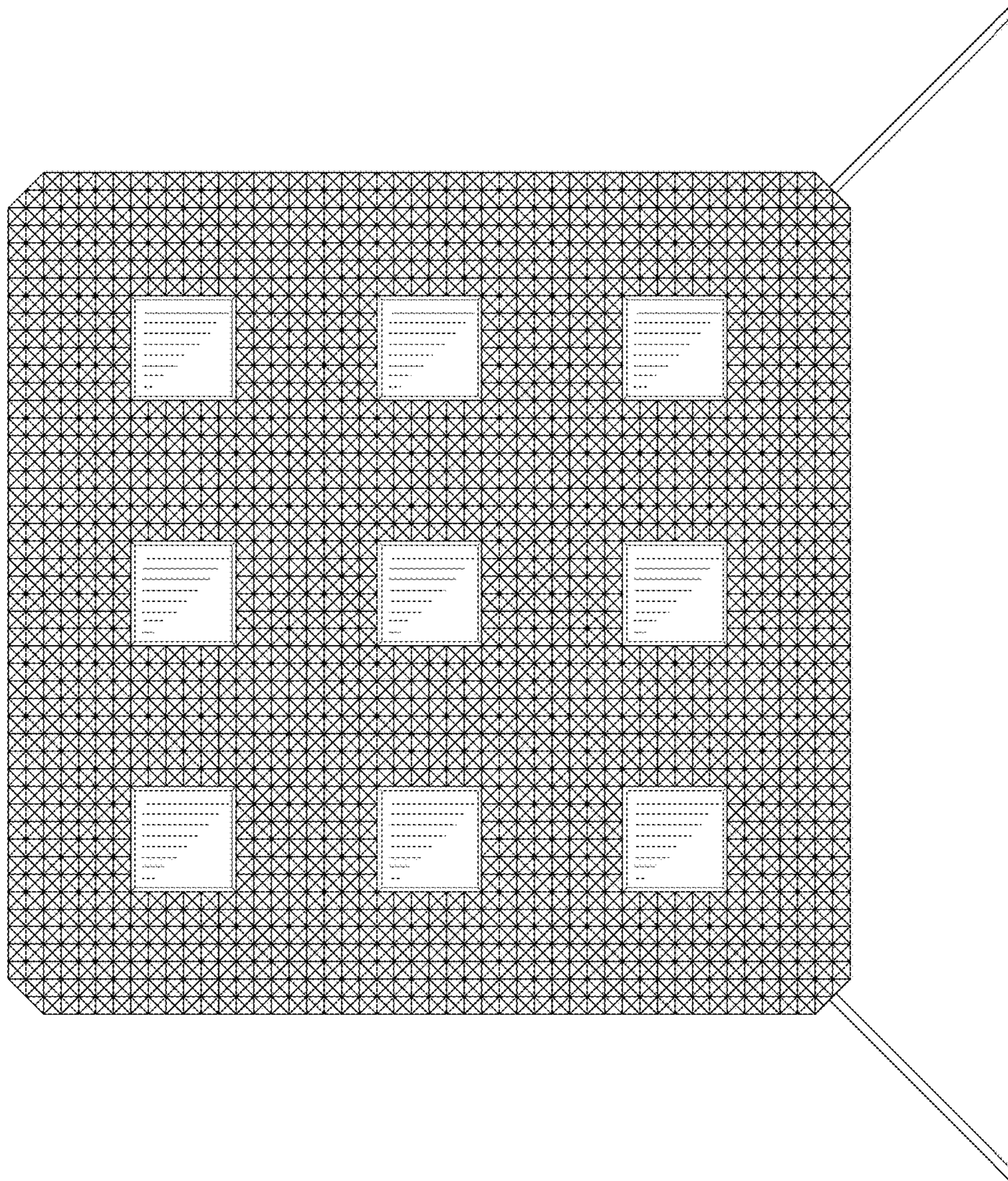

FIG. 7



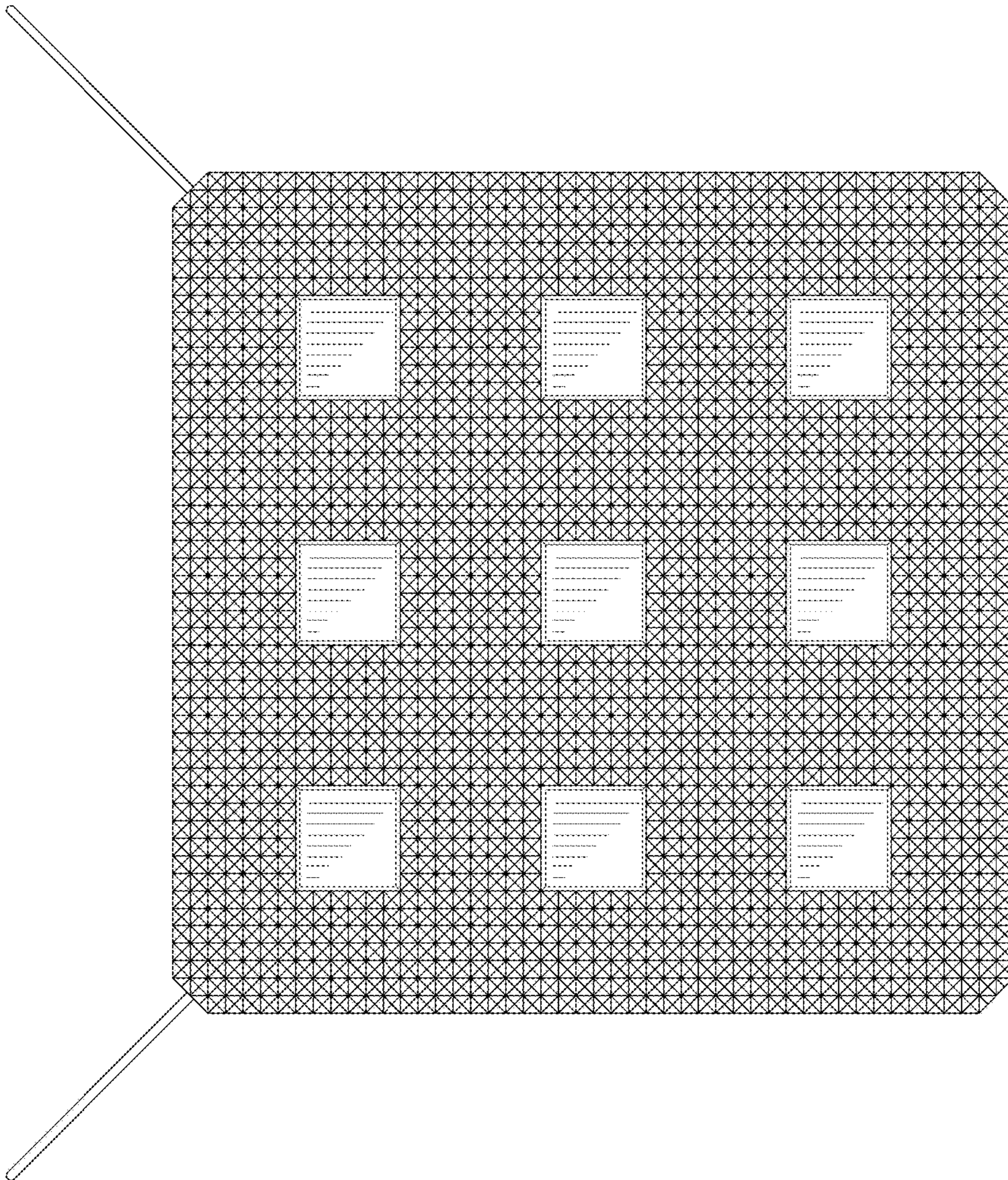

FIG. 8