



US00D847311S

(12) **United States Design Patent** (10) **Patent No.:** **US D847,311 S**
Allen (45) **Date of Patent:** **** Apr. 30, 2019**

(54) **SHOWER OR TUB SURROUND KIT**

(71) Applicant: **Francis Allen**, South Fork, CO (US)

(72) Inventor: **Francis Allen**, South Fork, CO (US)

(**) Term: **15 Years**

(21) Appl. No.: **29/601,670**

(22) Filed: **Apr. 25, 2017**

(51) **LOC (11) Cl.** **23-02**

(52) **U.S. Cl.**
USPC **D23/283**

(58) **Field of Classification Search**
USPC D23/283, 275, 305

(Continued)

(56) **References Cited**

U.S. PATENT DOCUMENTS

3,158,237 A 11/1964 Schooler
3,827,086 A 8/1974 Seymour et al.

(Continued)

Primary Examiner — Robert A Delehanty

(57) **CLAIM**

The ornamental design for a shower or tub surround kit, substantially as shown in the attached drawings.

DESCRIPTION

FIG. 1 is a perspective view of the shower or tub surround kit design;

FIG. 2 is an exploded perspective view of the design corresponding to FIG. 1, with the components separated for completeness of illustration;

FIG. 3 is a perspective view of an edging component of the shower or tub surround shown removed from the kit corresponding to FIG. 1 for clarity of disclosure;

FIG. 4 is a top view of the edging component shown in FIG. 3;

FIG. 5 is a bottom view of the edging component shown in FIG. 3;

FIG. 6 is a right side view of the edging component shown in FIG. 3;

FIG. 7 is a left side view of the edging component shown in FIG. 3;

FIG. 8 is a front view of the edging component shown in FIG. 3;

FIG. 9 is a back view of the edging component shown in FIG. 3;

FIG. 10 is a perspective view of a corner-side component of the shower or tub surround shown removed from the kit corresponding to FIG. 1 for clarity of disclosure;

FIG. 11 is a top view of the corner-side component shown in FIG. 10;

FIG. 12 is a bottom view of the corner-side component shown in FIG. 10;

FIG. 13 is a right side view of the corner-side component shown in FIG. 10;

FIG. 14 is a left side view of the corner-side component shown in FIG. 10;

FIG. 15 is a front view of the corner-side component shown in FIG. 10;

FIG. 16 is a back view of the corner-side component shown in FIG. 10;

FIG. 17 is a perspective view of a corner component of the shower or tub surround shown removed from the kit corresponding to FIG. 1 for clarity of disclosure;

FIG. 18 is a top view of the corner component shown in FIG. 17;

FIG. 19 is a bottom view of the corner component shown in FIG. 17;

FIG. 20 is a right side view of the corner component shown in FIG. 17;

FIG. 21 is a left side view of the corner component shown in FIG. 17;

FIG. 22 is a front view of the corner component shown in FIG. 17;

(Continued)

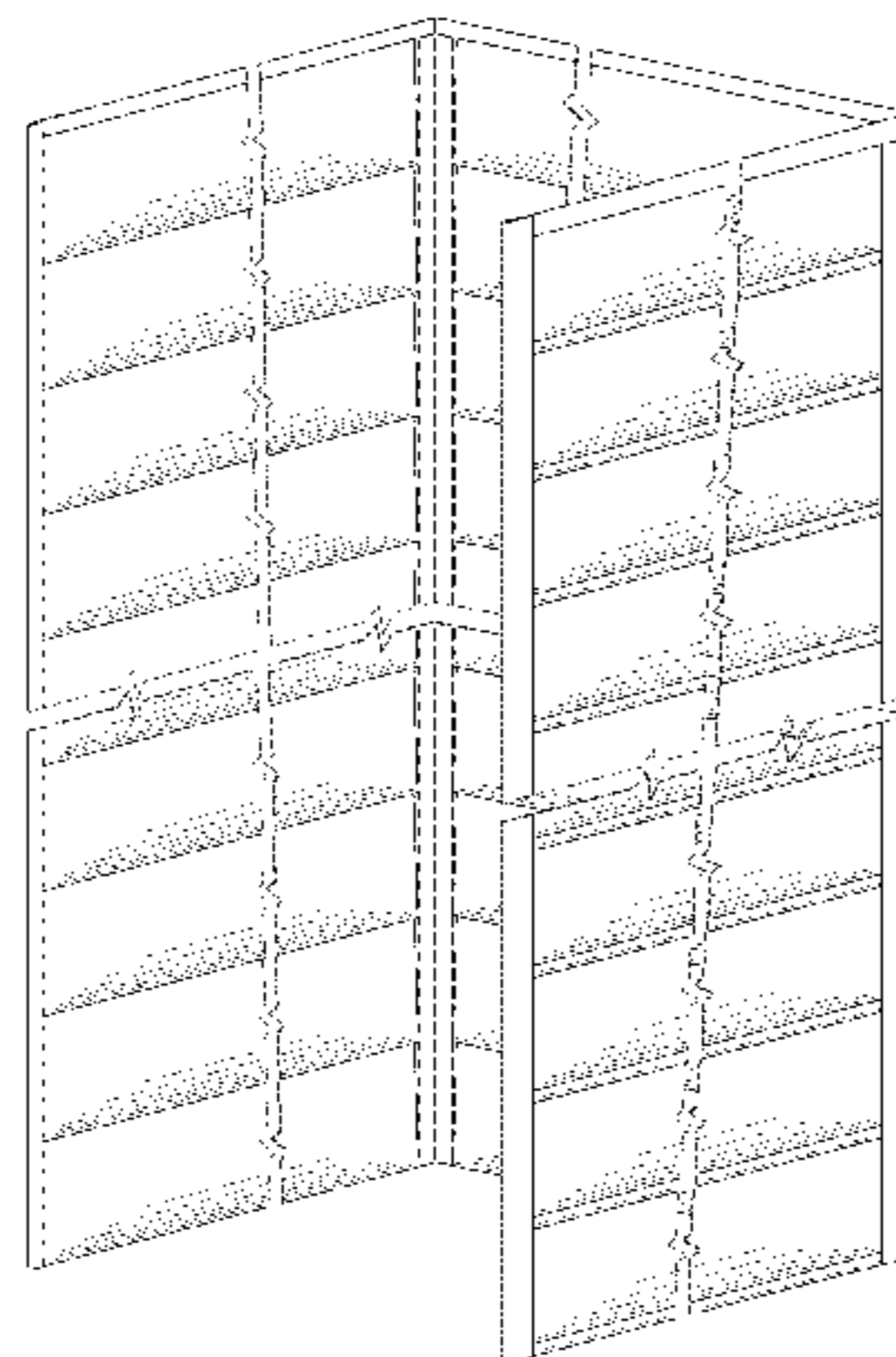

FIG. 23 is a back view of the corner component shown in FIG. 17;
 FIG. 24 is a perspective view of a wall panel component of the shower or tub surround shown removed from the kit corresponding to FIG. 1 for clarity of disclosure;
 FIG. 25 is a top view of the wall panel component shown in FIG. 24;
 FIG. 26 is a bottom view of the wall panel component shown in FIG. 24;
 FIG. 27 is a right side view of the wall panel component shown in FIG. 24;
 FIG. 28 is a left side view of the wall panel component shown in FIG. 24;
 FIG. 29 is a front view of the wall panel component shown in FIG. 24;
 FIG. 30 is a back view of the wall panel component shown in FIG. 24;
 FIG. 31 is a perspective view of the corner-side component shown in FIG. 10 as it may be assembled to the corner component shown in FIG. 17, shown removed from the kit corresponding to FIG. 1 for clarity of disclosure;
 FIG. 32 is an exploded perspective view of the corner-side component assembled to the corner component as shown in FIG. 31, with the components separated for completeness of illustration;
 FIG. 33 is a perspective view of the shower or tub surround kit design shown as it may be installed on a bathtub, wherein the bathtub, handle, and faucet are shown in dashed lines to indicate environment and do not form a part of the design;
 and,
 FIG. 34 is a perspective view of the shower or tub surround kit design shown as it may be installed on a shower, wherein the shower pan, handle, and shower head are shown in dashed lines to indicate environment and do not form a part of the design.

The claim is shown with a symbolic break in its length. The appearance of any portion of the article between the break lines forms no part of the claimed design.

1 Claim, 17 Drawing Sheets

(58) **Field of Classification Search**

CPC . A47K 1/28; A47K 1/30; A47K 1/307; A47K 1/32; Y10T 29/4943

See application file for complete search history.

(56) **References Cited**

U.S. PATENT DOCUMENTS

4,384,377	A	5/1983	Calvert et al.	
4,569,092	A	2/1986	Baus	
4,817,344	A	4/1989	Wissinger	
4,993,201	A *	2/1991	Bunyard	A47K 3/284 4/596
5,079,880	A *	1/1992	Reid	A47K 3/008 52/288.1
5,303,519	A *	4/1994	Mustee	A47K 3/283 52/34
5,435,021	A	7/1995	Williams	
5,671,489	A *	9/1997	Salach	A47K 3/282 4/584
D445,491	S *	7/2001	Paredes	A47K 3/281 D23/305
D495,789	S *	9/2004	Helmetsie	D23/283
D561,308	S *	2/2008	Breymaier	D23/275
8,037,556	B2 *	10/2011	Lock	A47K 3/284 4/596
8,484,771	B2 *	7/2013	Wilson	A47K 3/30 4/600
D709,599	S *	7/2014	Lobley	D23/283
9,506,253	B2 *	11/2016	Rosko	E04F 13/0873
9,642,500	B2 *	5/2017	Groner	A47K 3/30
9,833,111	B2 *	12/2017	Torres	A47K 3/30
2008/0250558	A1	10/2008	Torres	

* cited by examiner

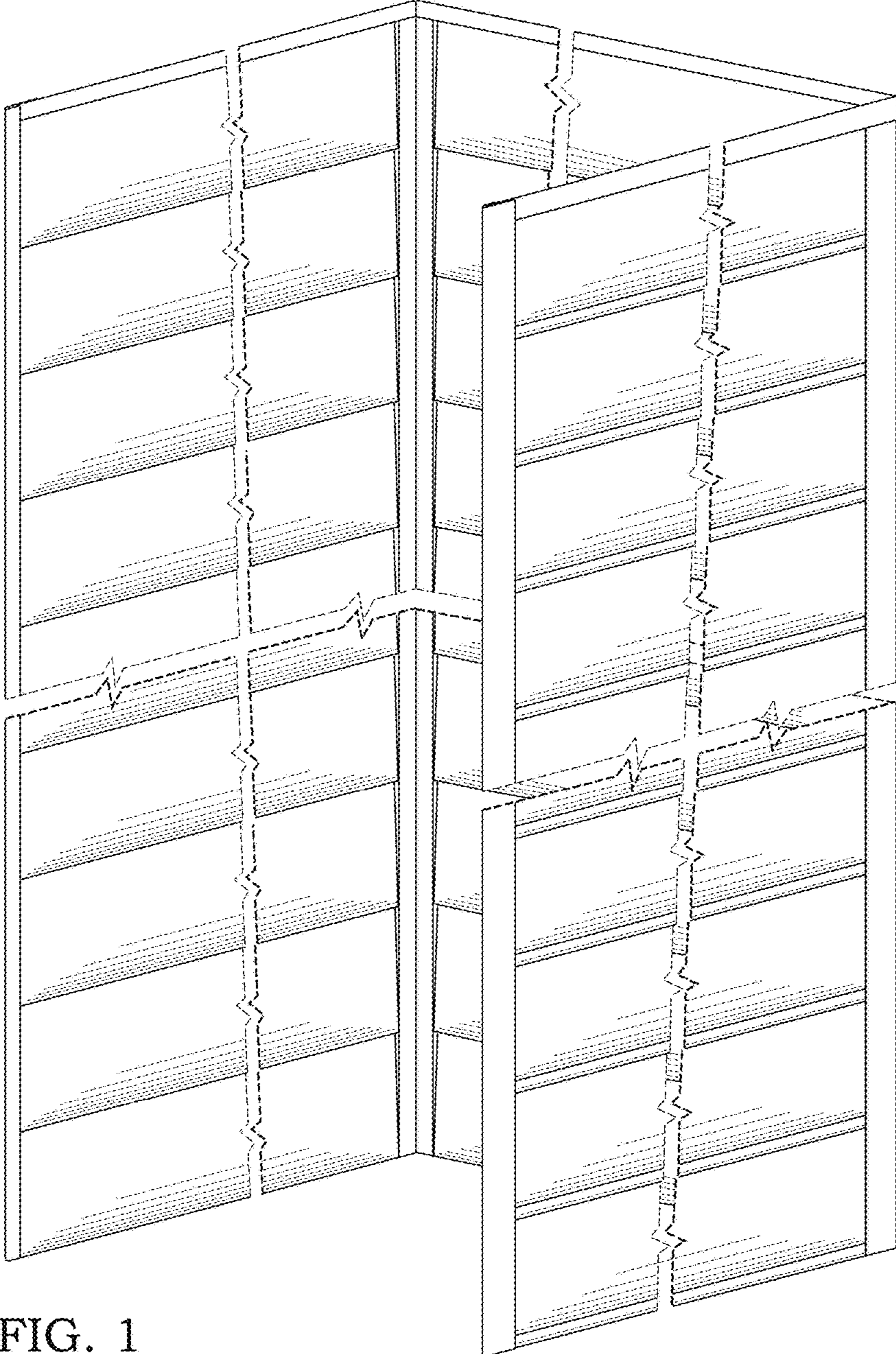

FIG. 1

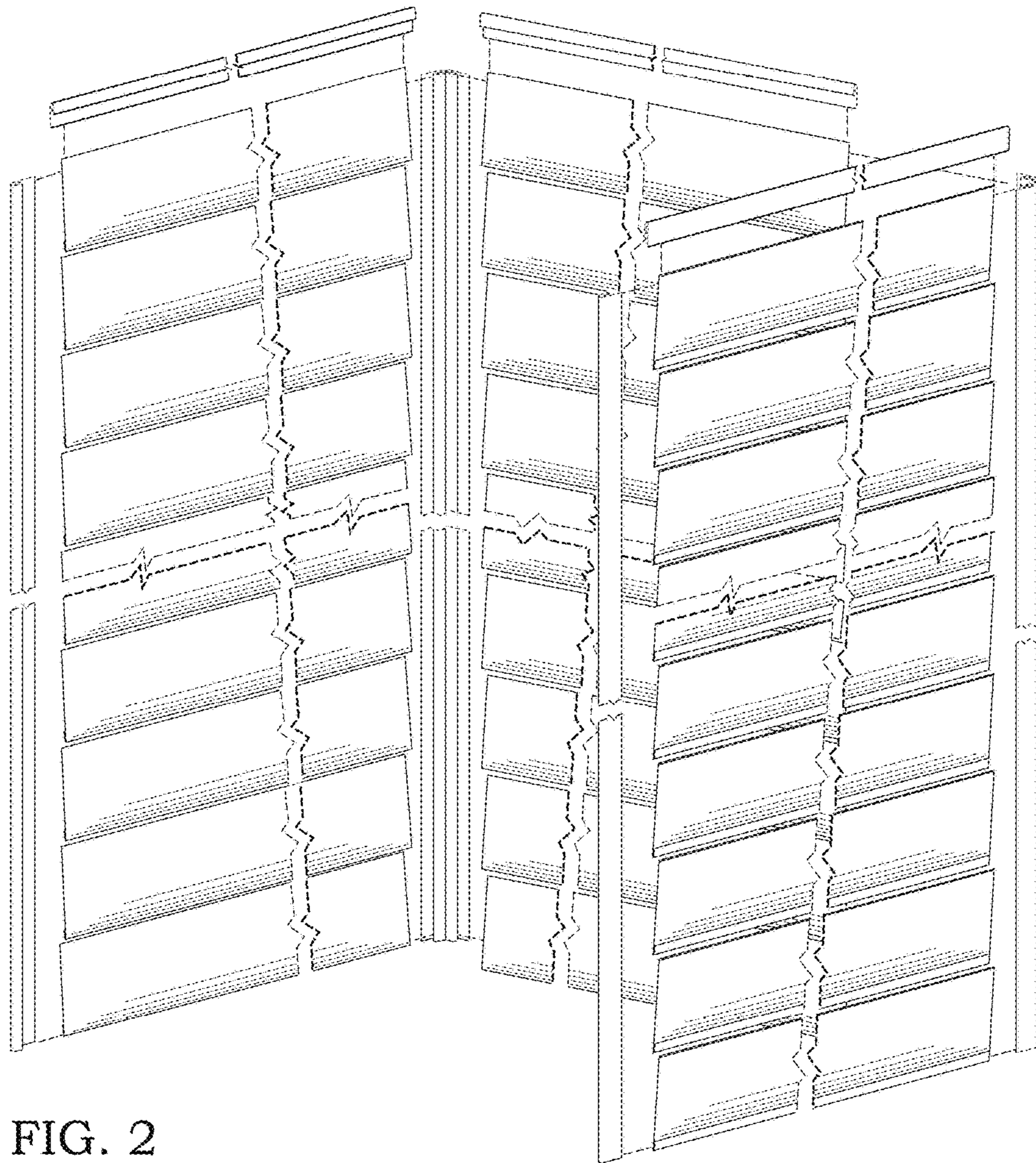

FIG. 2

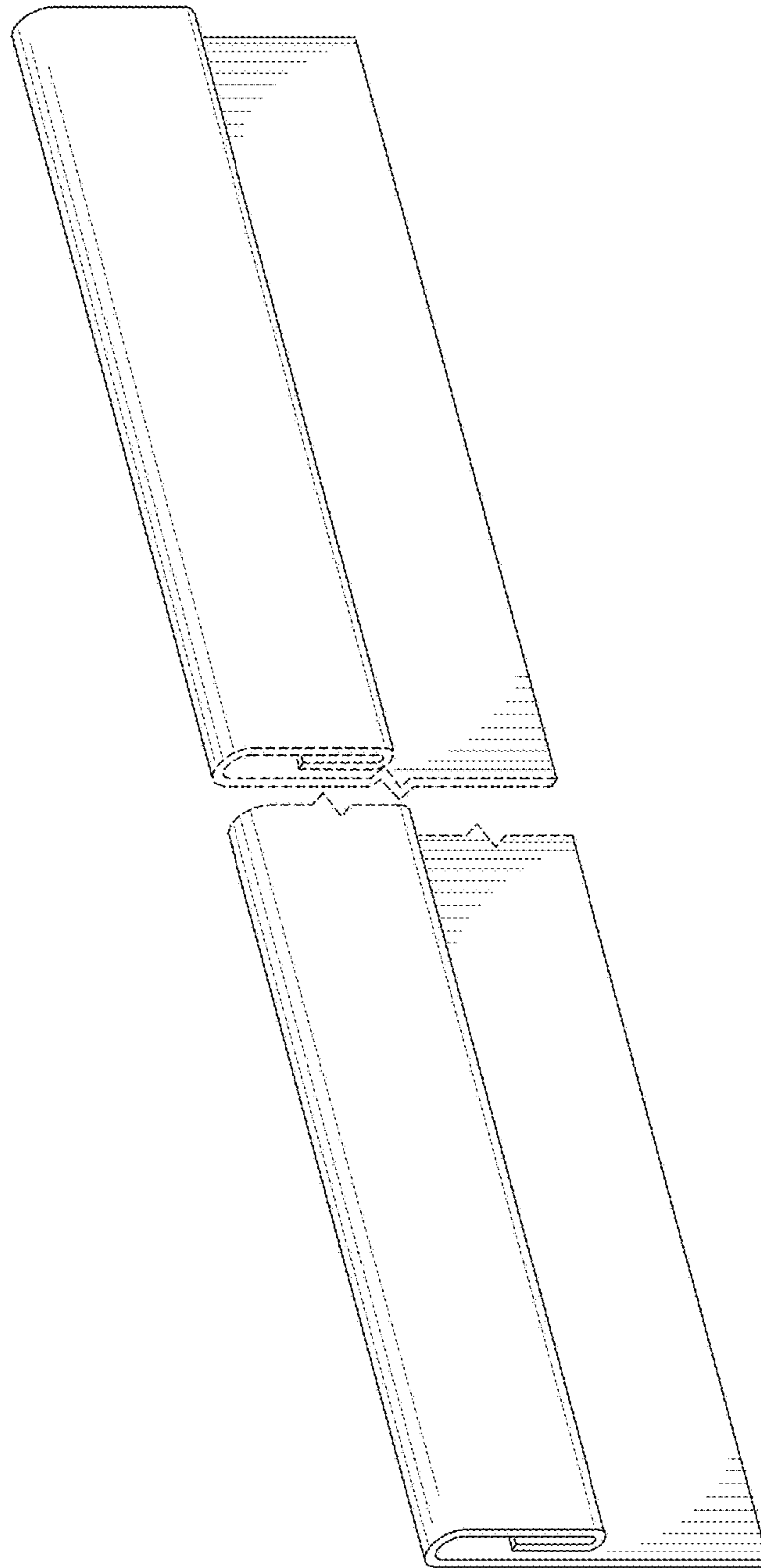

FIG. 3

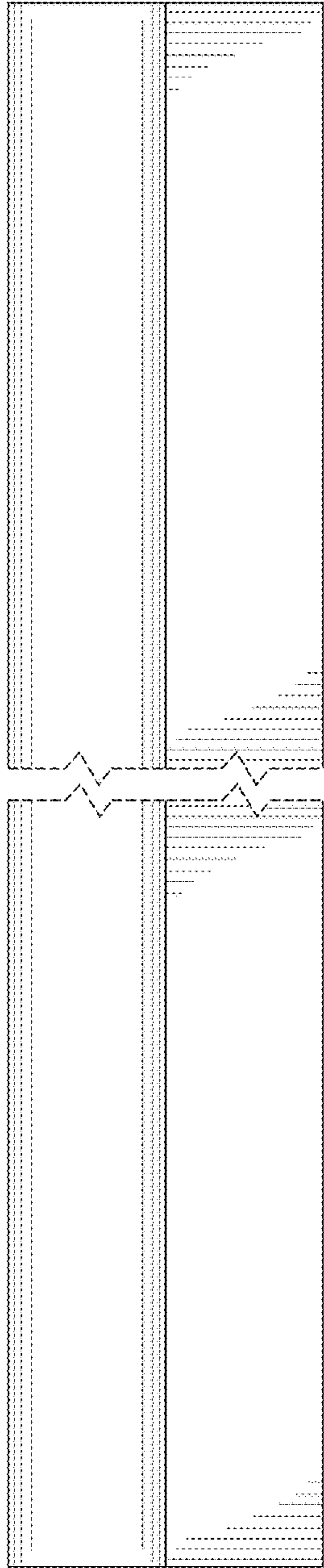

FIG. 4

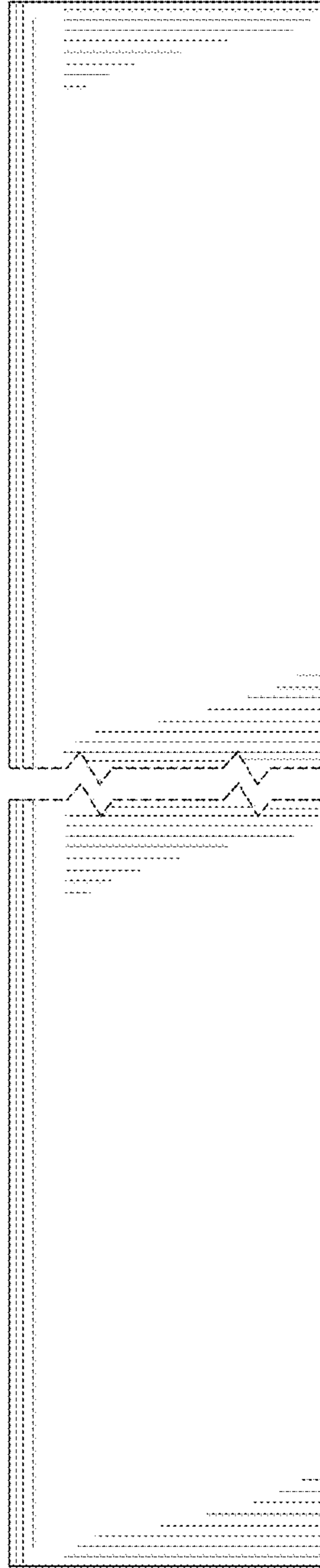

FIG. 5



FIG. 6



FIG. 7

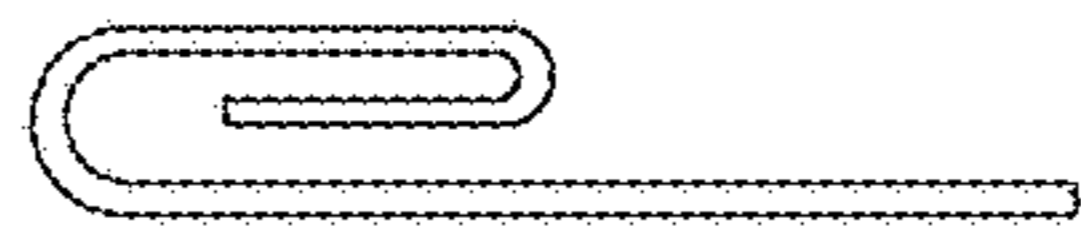

FIG. 8

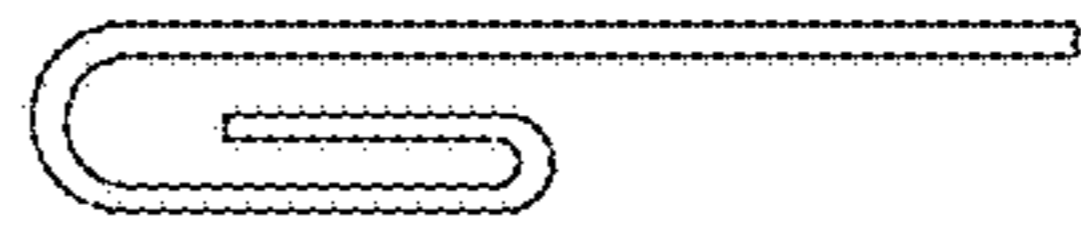

FIG. 9

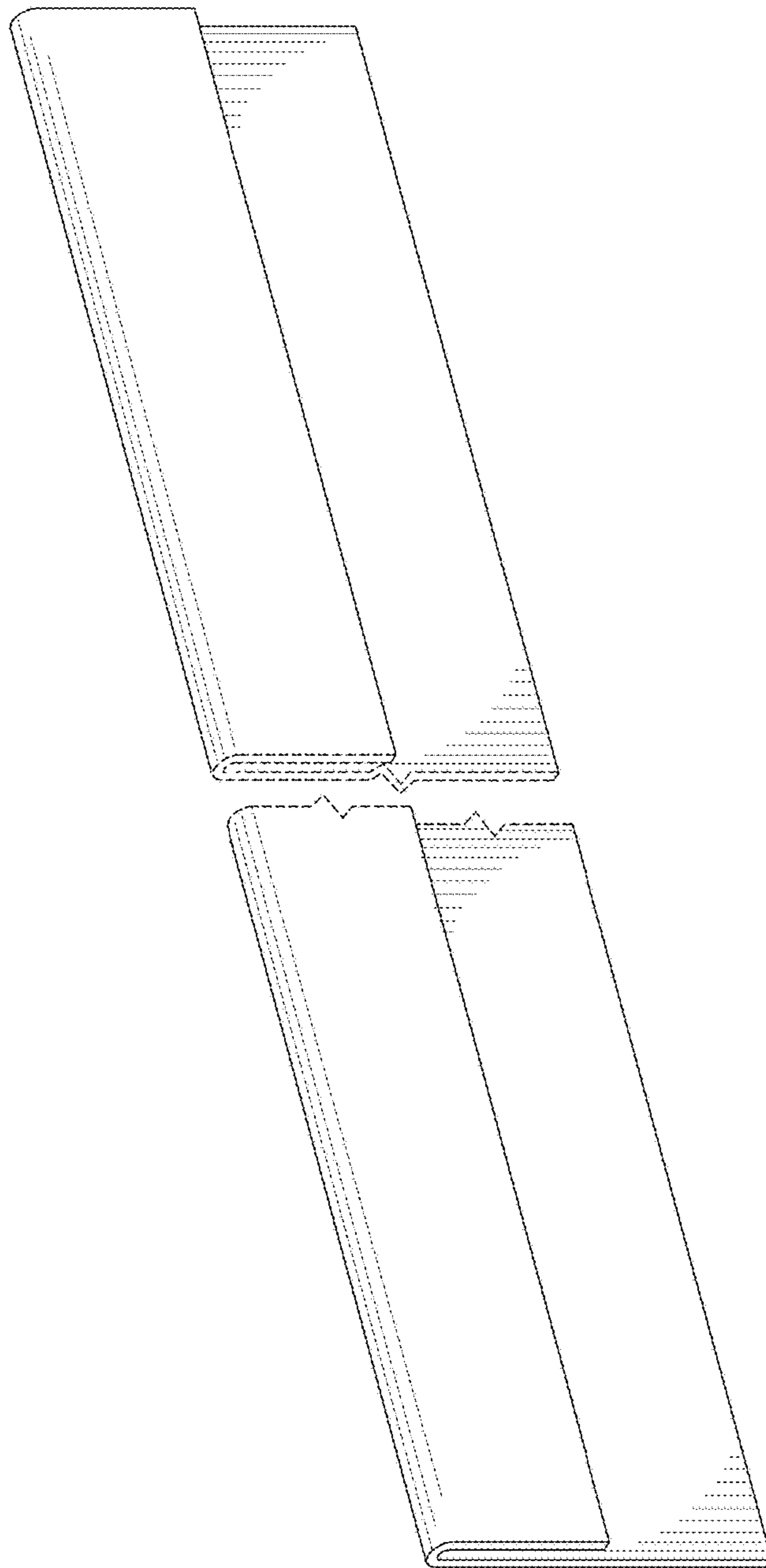

FIG. 10

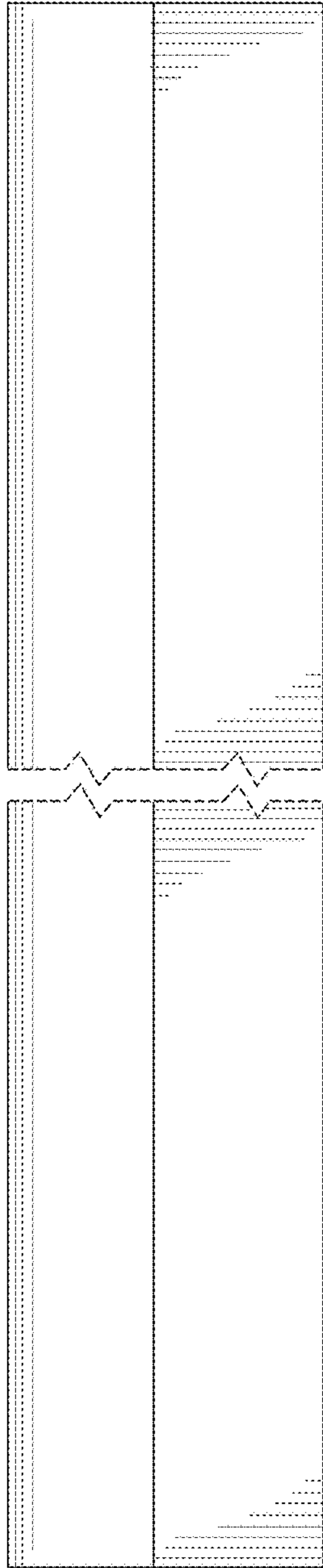

FIG. 11

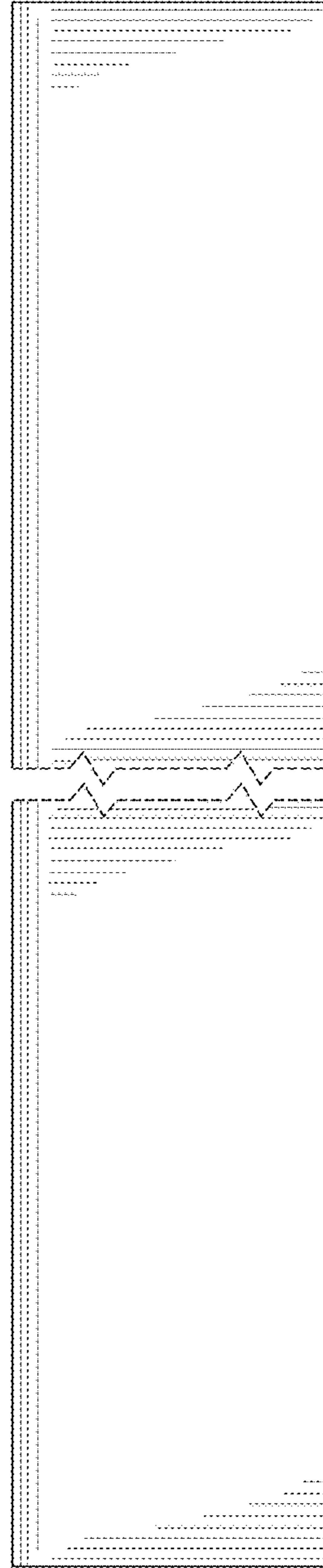

FIG. 12



FIG. 13

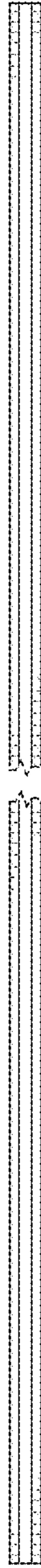

FIG. 14

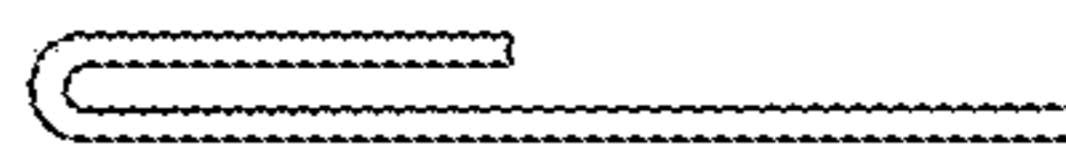

FIG. 15

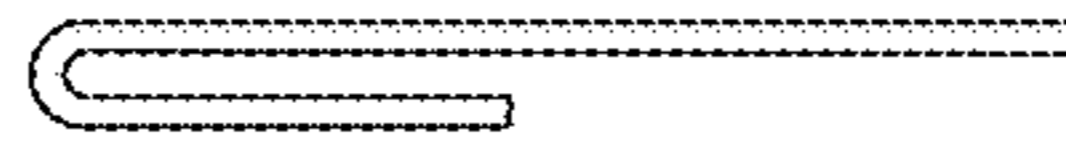

FIG. 16

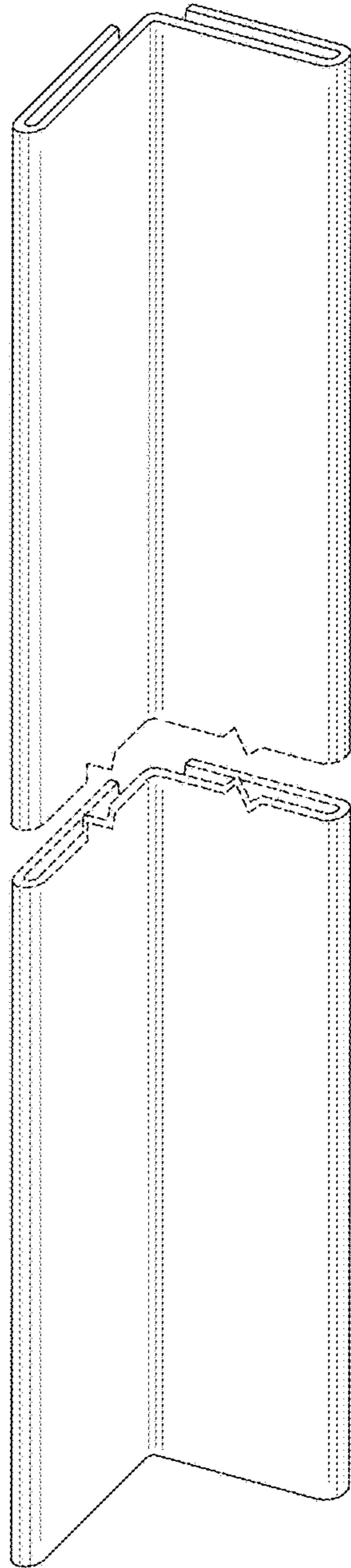

FIG. 17

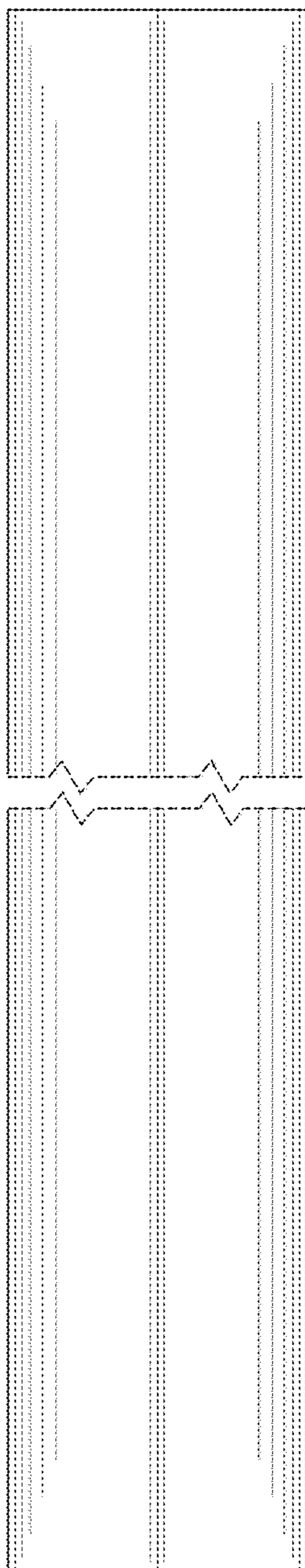

FIG. 18

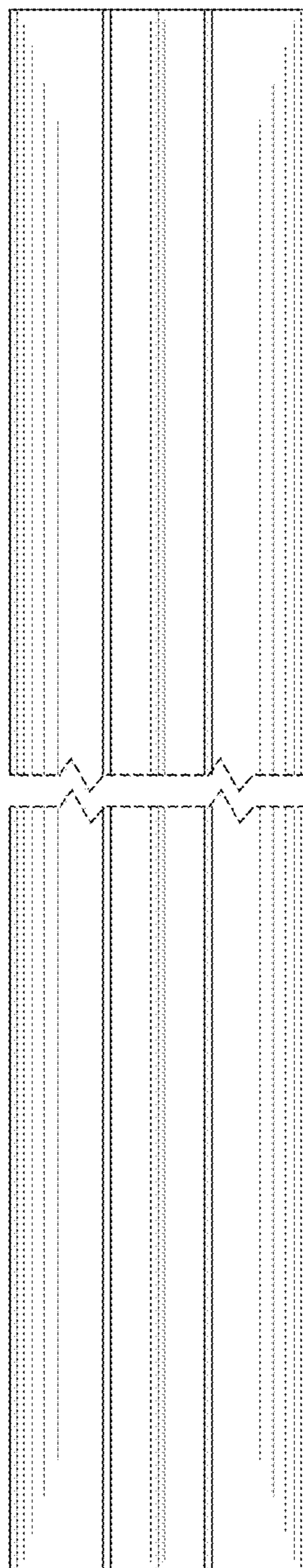

FIG. 19

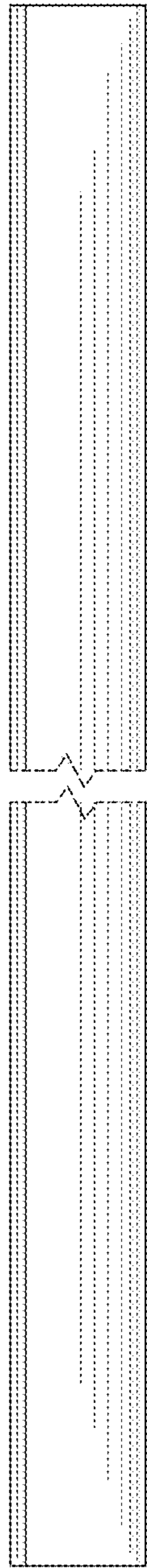

FIG. 20

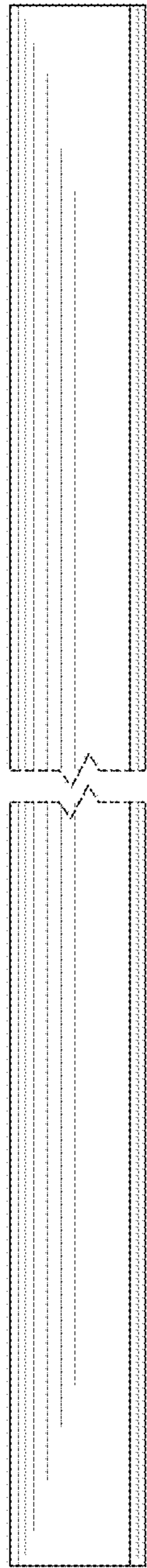

FIG. 21

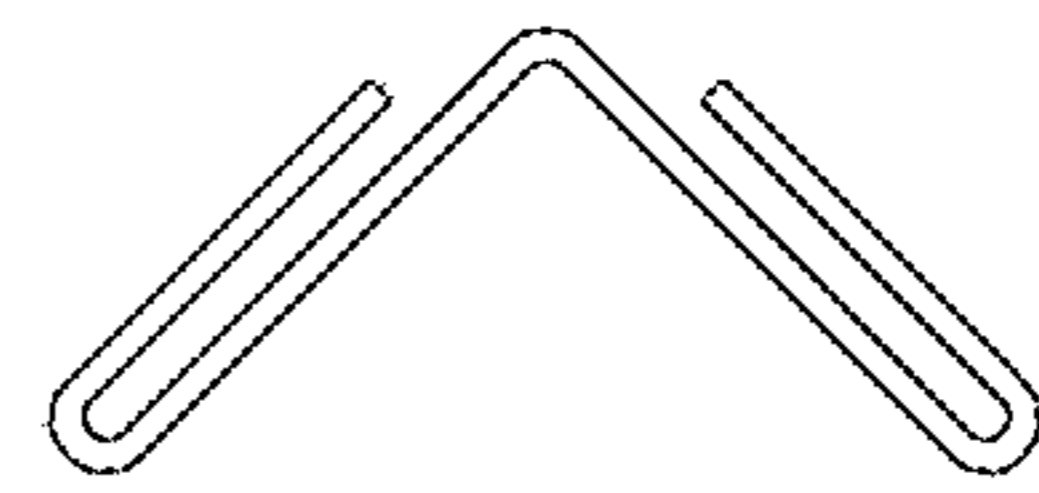

FIG. 22

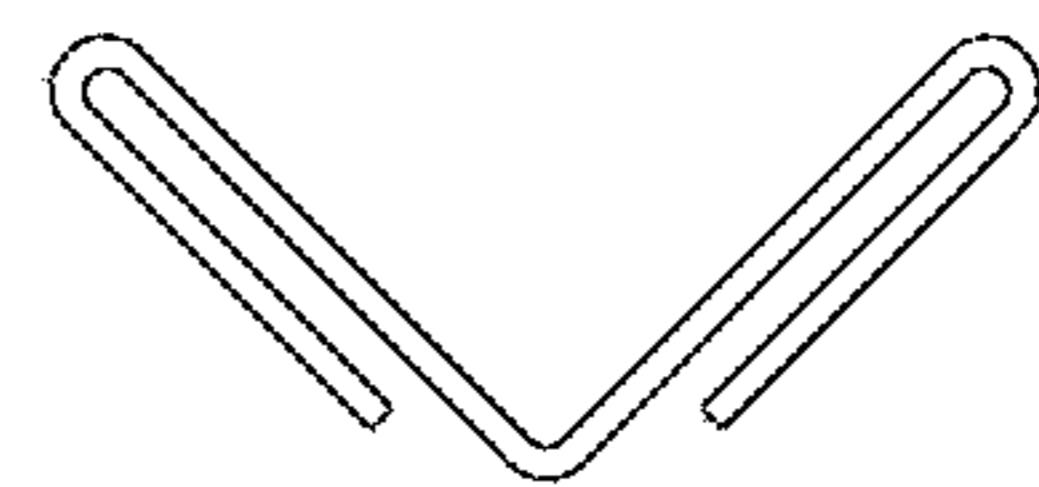

FIG. 23

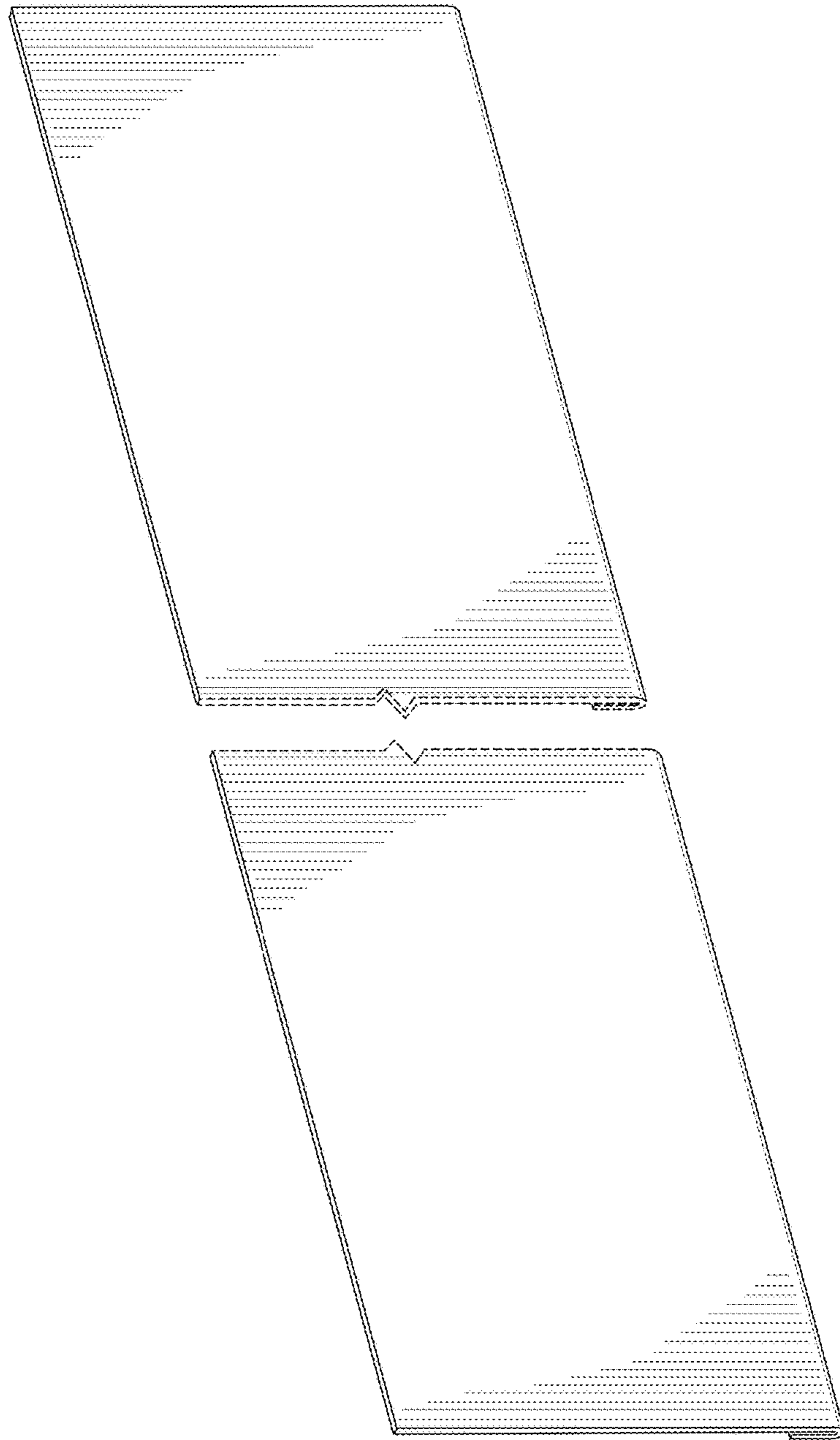

FIG. 24

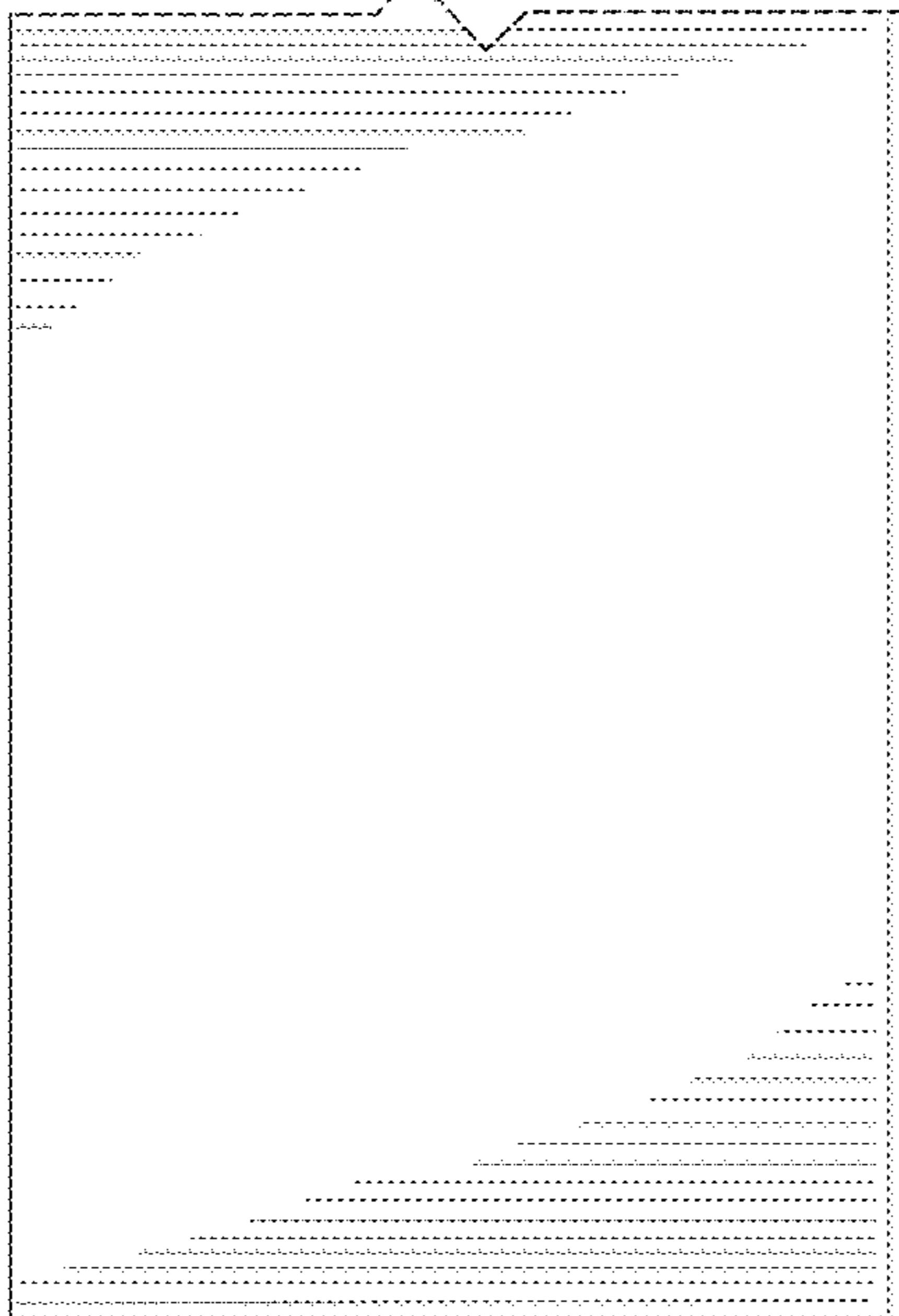
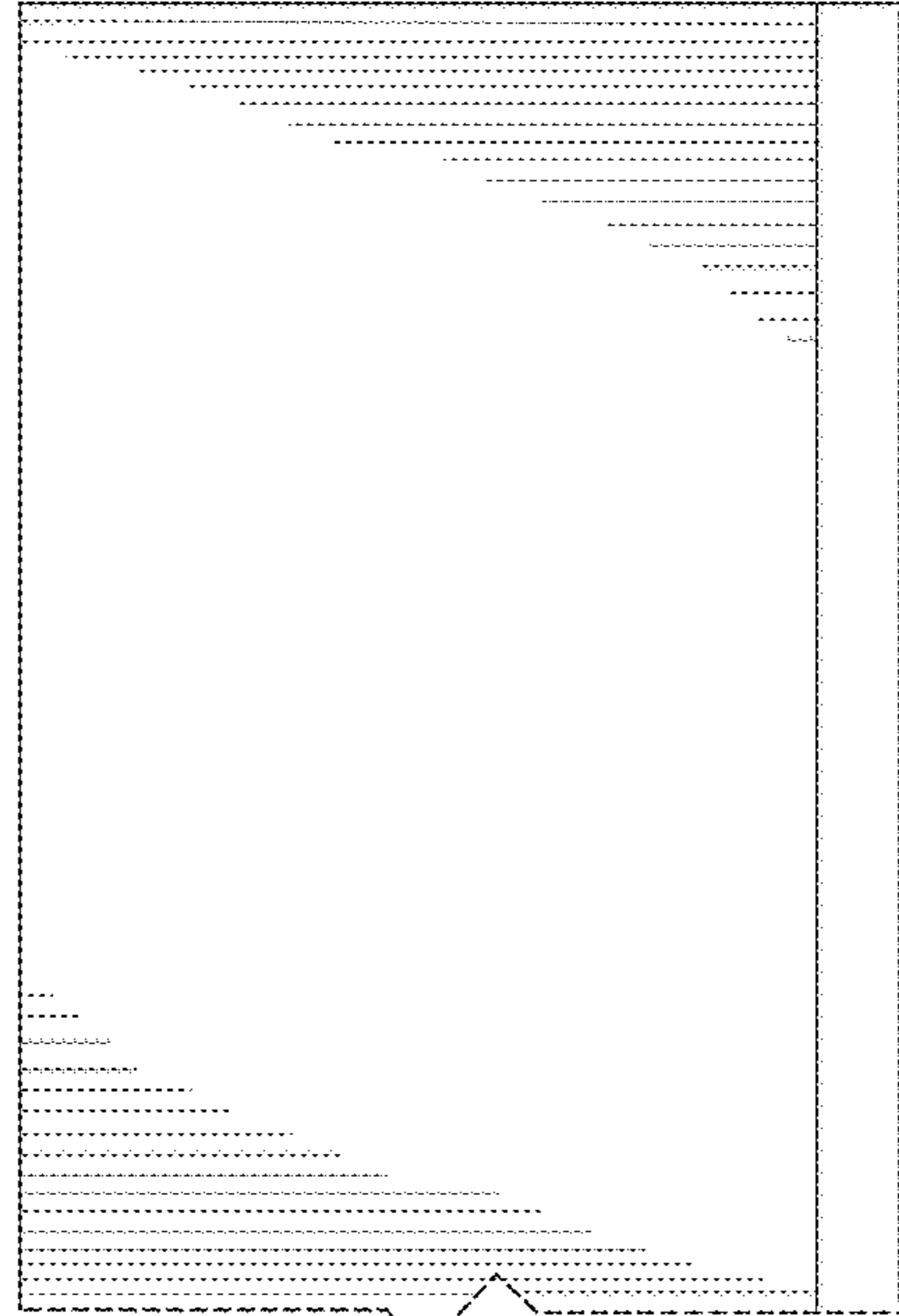
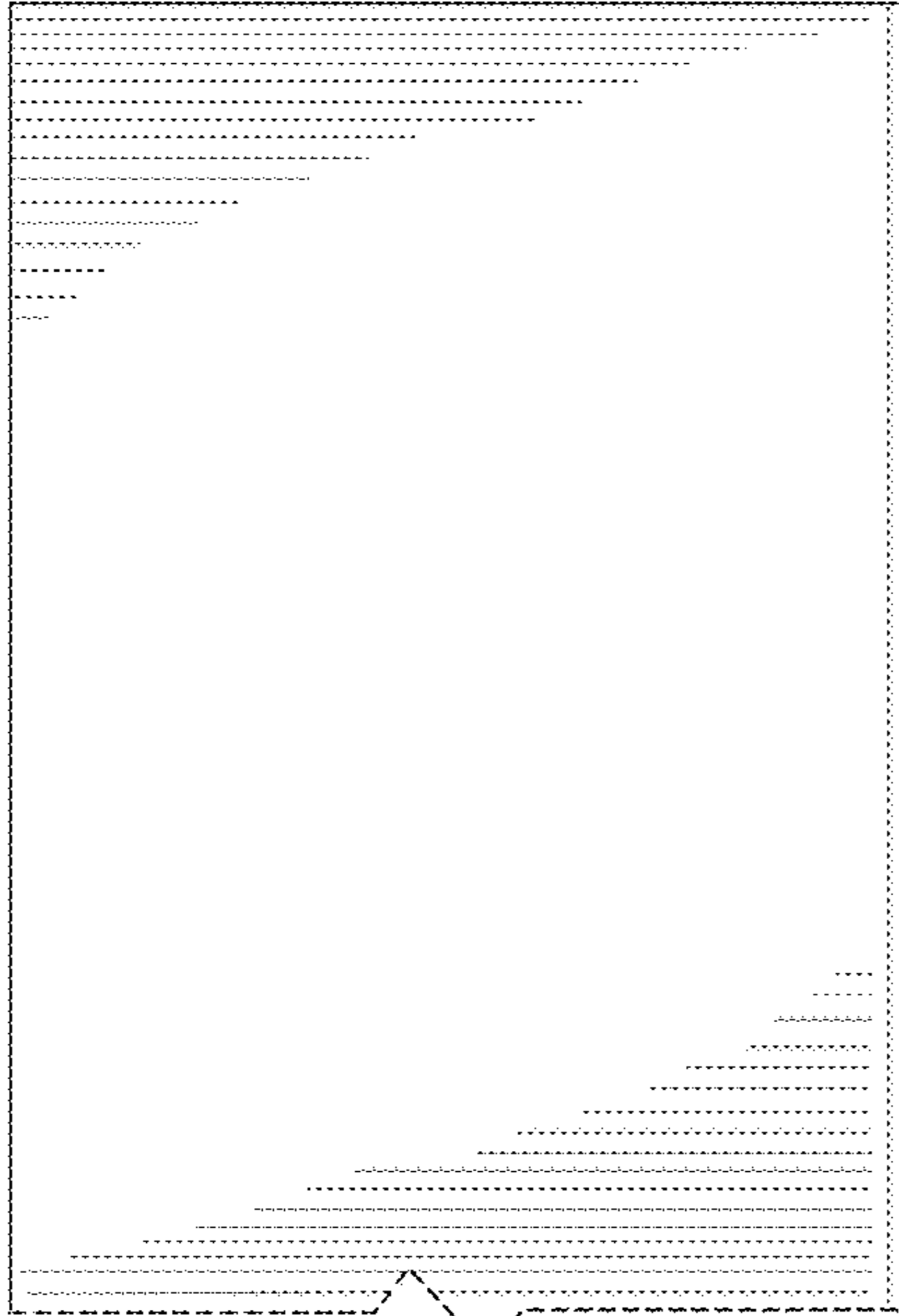

FIG. 25

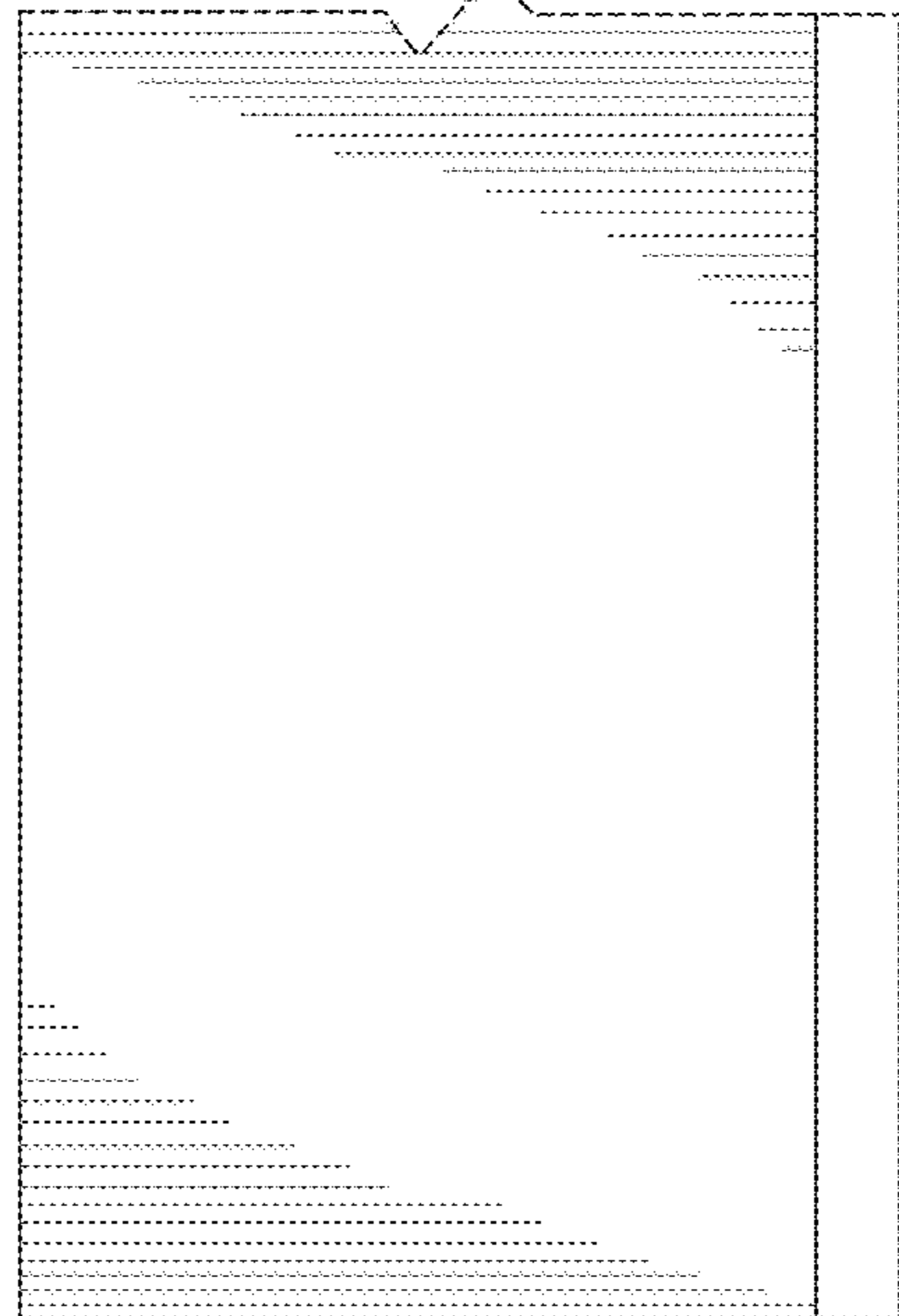

FIG. 26

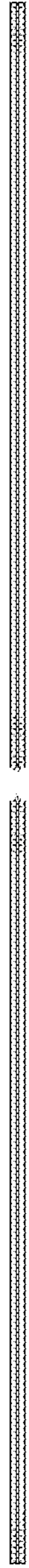

FIG. 27

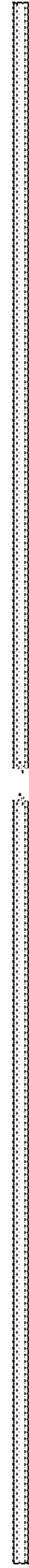

FIG. 28

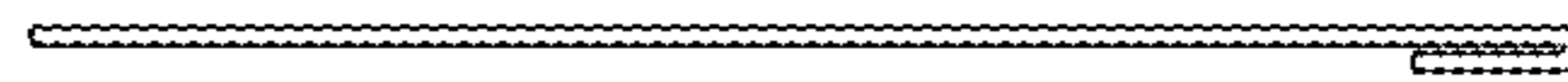

FIG. 29

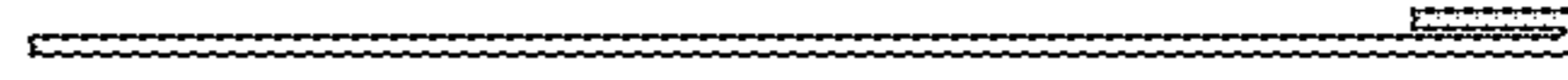

FIG. 30

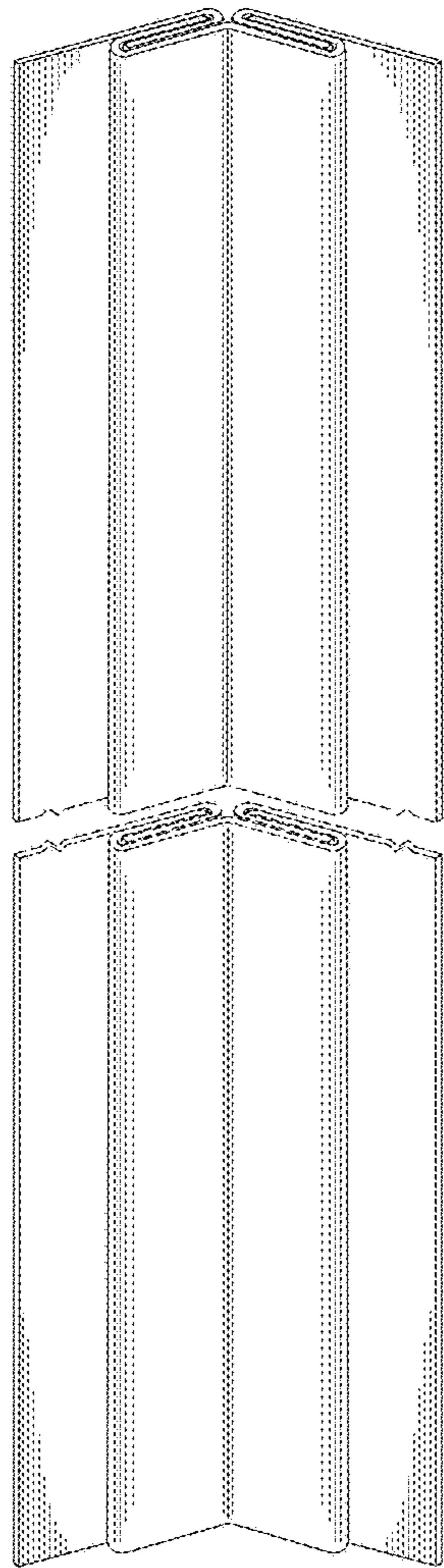

FIG. 31

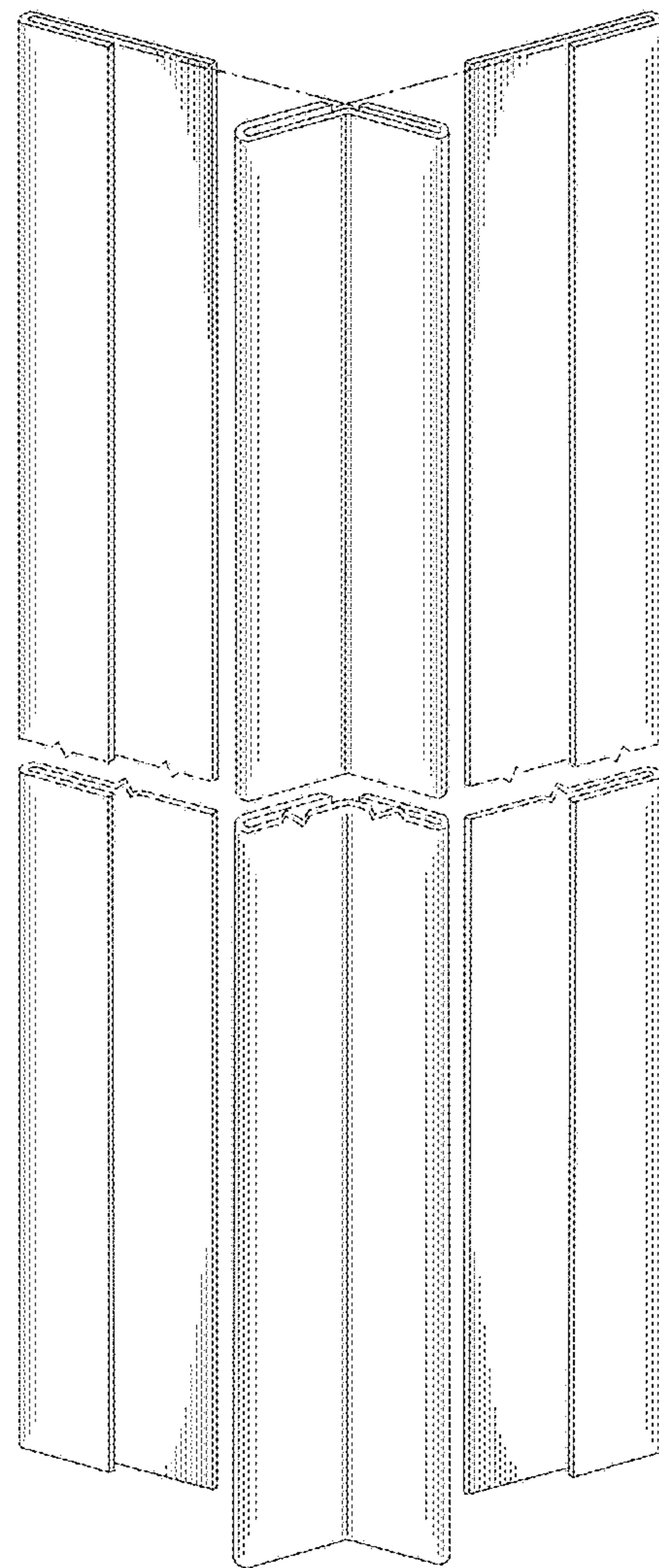

FIG. 32

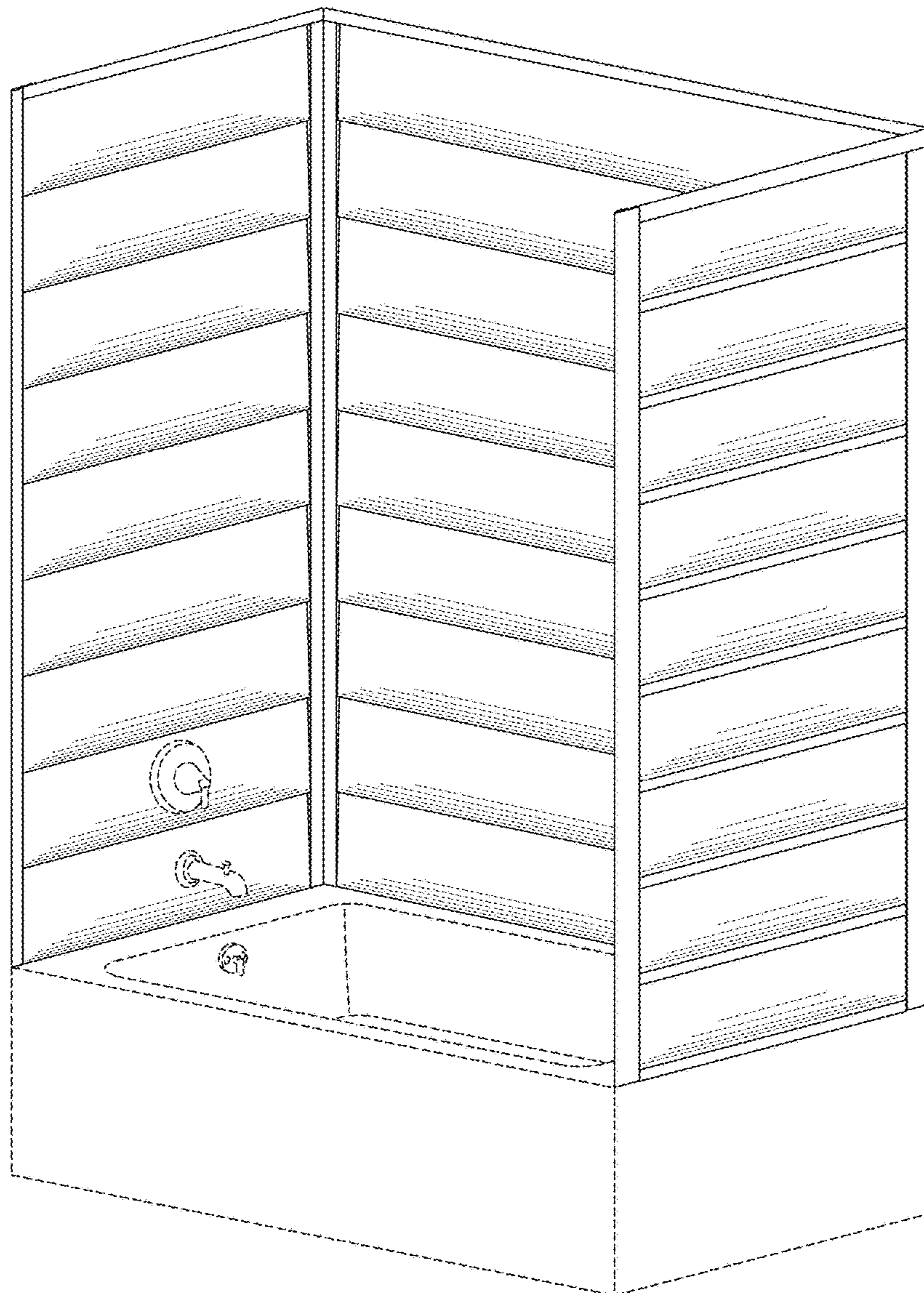

FIG. 33

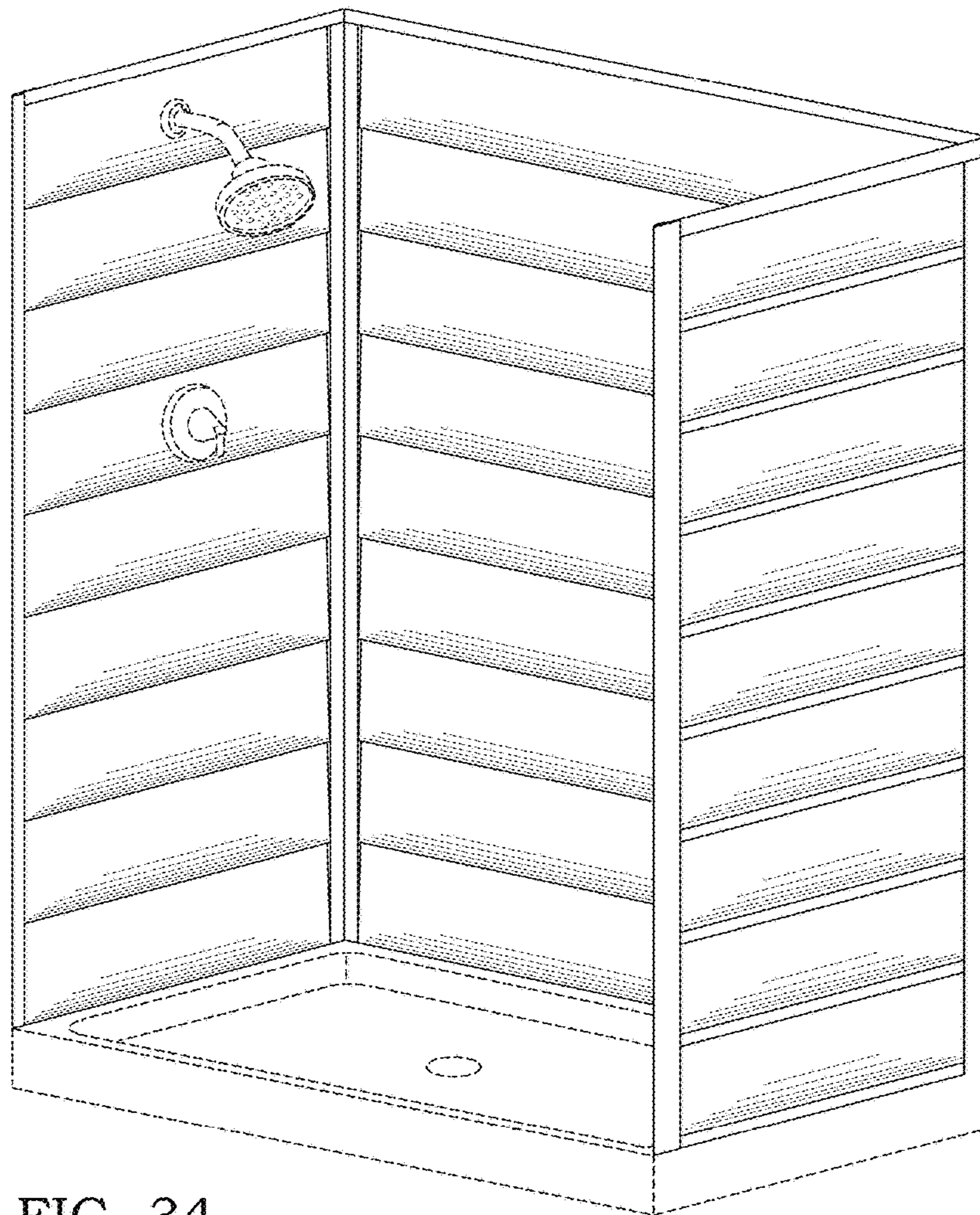

FIG. 34