



US00D847300S

(12) **United States Design Patent**
Graham et al.

(10) **Patent No.:** **US D847,300 S**

(45) **Date of Patent:** **** Apr. 30, 2019**

(54) **FILTER**

(71) Applicant: **Parker Hannifin EMEA S.à.r.l.**, Etoy (CH)

(72) Inventors: **Michael Graham**, Cramlington (GB);
Stephen Stewart, Morpeth (GB);
Dominic James Thompson, West Moor (GB);
Callum Russell Whitehead, Stockton On Tees (GB)

(73) Assignee: **PARKER HANNIFIN EMEA S.À.R.L.**, Etoy (CH)

(**) Term: **15 Years**

(21) Appl. No.: **29/625,241**

(22) Filed: **Nov. 8, 2017**

(51) **LOC (11) Cl.** **23-01**

(52) **U.S. Cl.**
USPC **D23/209**

(58) **Field of Classification Search**
USPC D23/200, 207, 209
CPC B01D 35/30; B01D 35/153; B01D 35/306;
B01D 2201/30; B01D 2201/29; B01D 24/10;
B01D 36/02; C02F 1/002; C02F 1/003

See application file for complete search history.

(56) **References Cited**

U.S. PATENT DOCUMENTS

D220,263 S * 3/1971 Hughes B01D 35/30
D23/209
D374,912 S * 10/1996 Englander B01D 35/147
D23/209

D482,101 S * 11/2003 Rampen D23/209
D502,531 S * 3/2005 Liu D23/209
D582,002 S * 12/2008 Suthmann D23/209
7,967,981 B2 * 6/2011 Talamali B01D 35/30
210/232
10,092,868 B2 * 10/2018 Honermann B01D 35/147

* cited by examiner

Primary Examiner — Robin V Webster

(74) *Attorney, Agent, or Firm* — Christopher Hunter

(57) **CLAIM**

The ornamental design for a filter, as shown and described.

DESCRIPTION

FIG. 1 is a perspective view of a first embodiment of a filter showing our design.

FIG. 2 is a left side view thereof.

FIG. 3 is a right side view thereof.

FIG. 4 is a front view thereof.

FIG. 5 is a rear view thereof.

FIG. 6 is a top view thereof.

FIG. 7 is a bottom view thereof.

FIG. 8 is a perspective view of a second embodiment of a filter showing our design.

FIG. 9 is a left side view thereof.

FIG. 10 is a right side view thereof.

FIG. 11 is a front view thereof.

FIG. 12 is a rear view thereof.

FIG. 13 is a top view thereof; and,

FIG. 14 is a bottom view thereof.

The broken line showing in FIGS. 1 and 8 is included for the purpose of illustrating and forms no part of the claimed design.

1 Claim, 12 Drawing Sheets

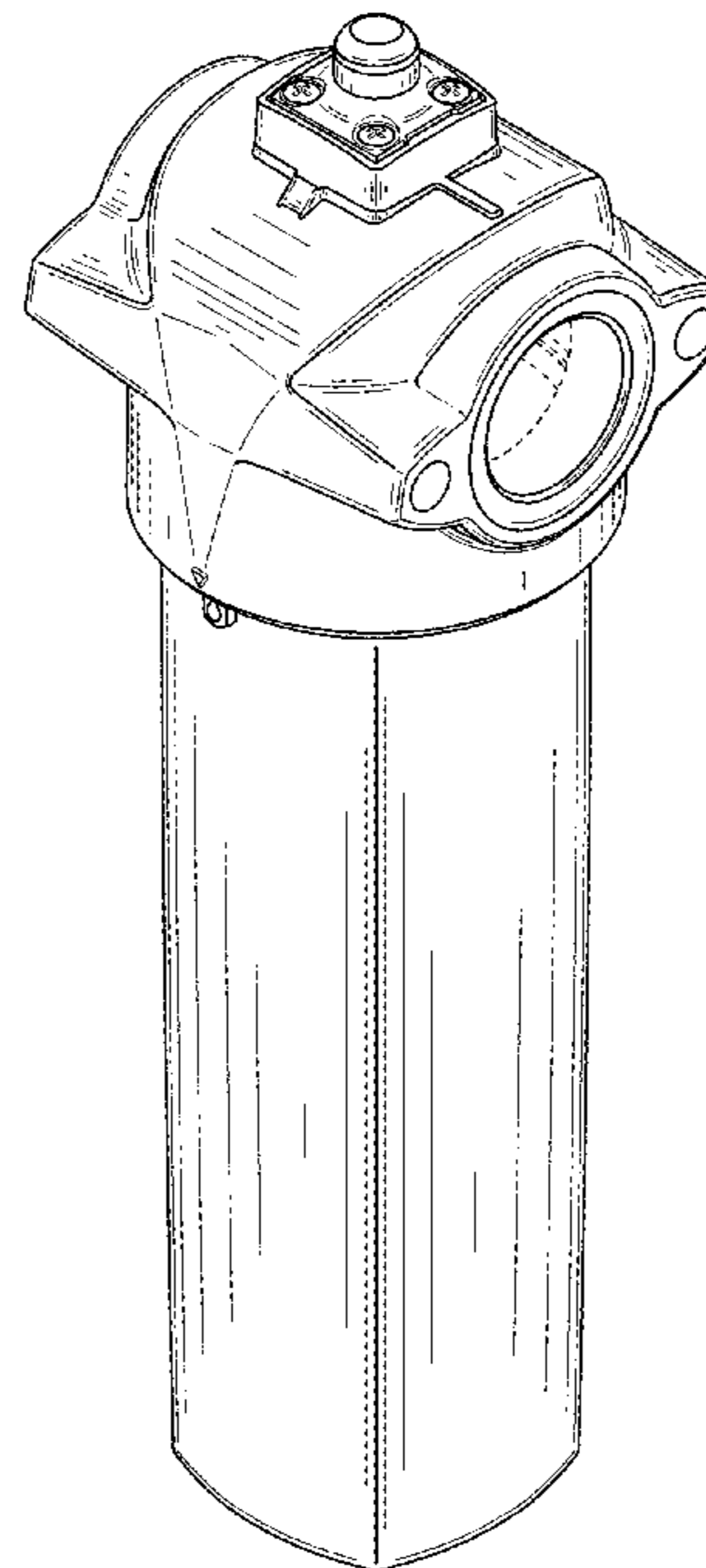
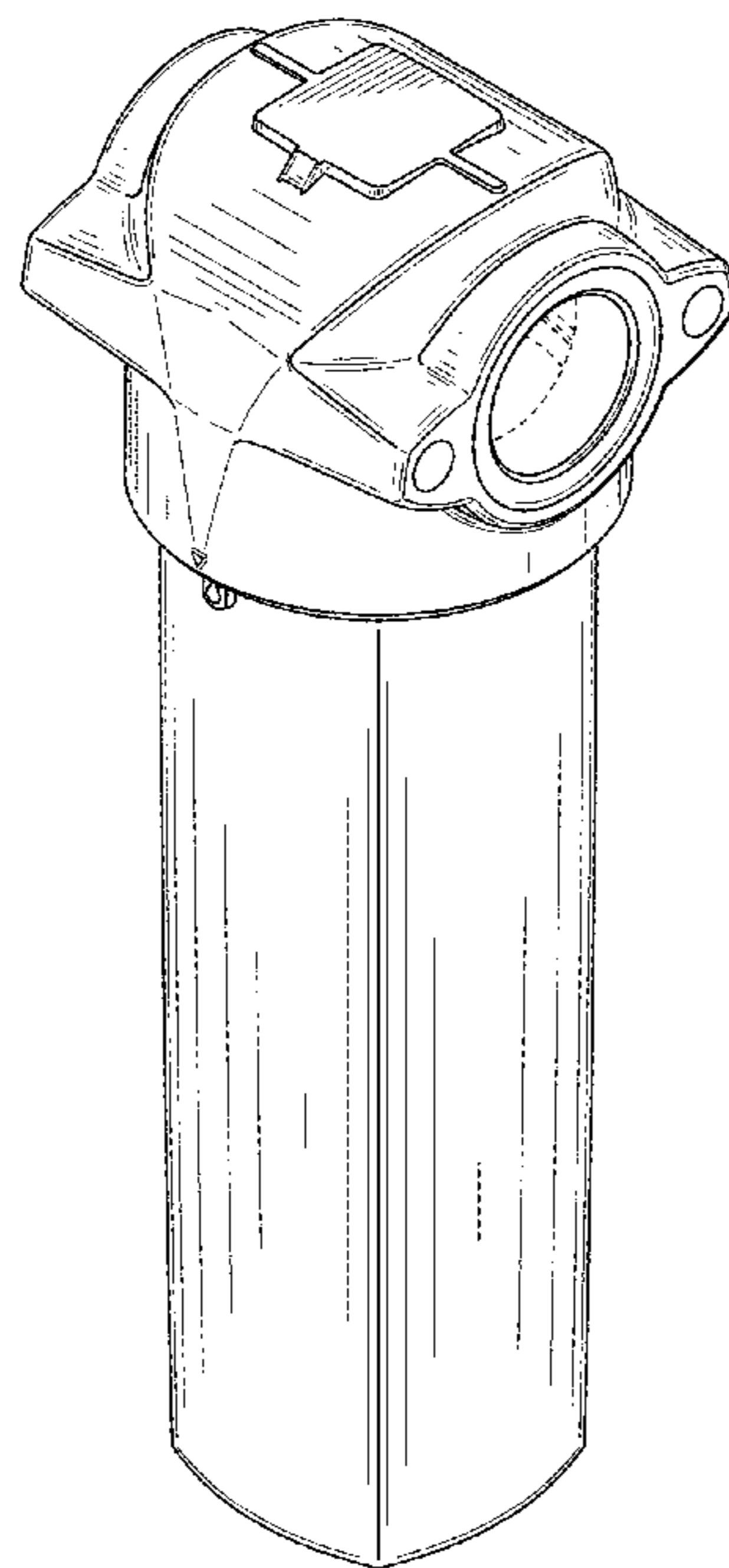

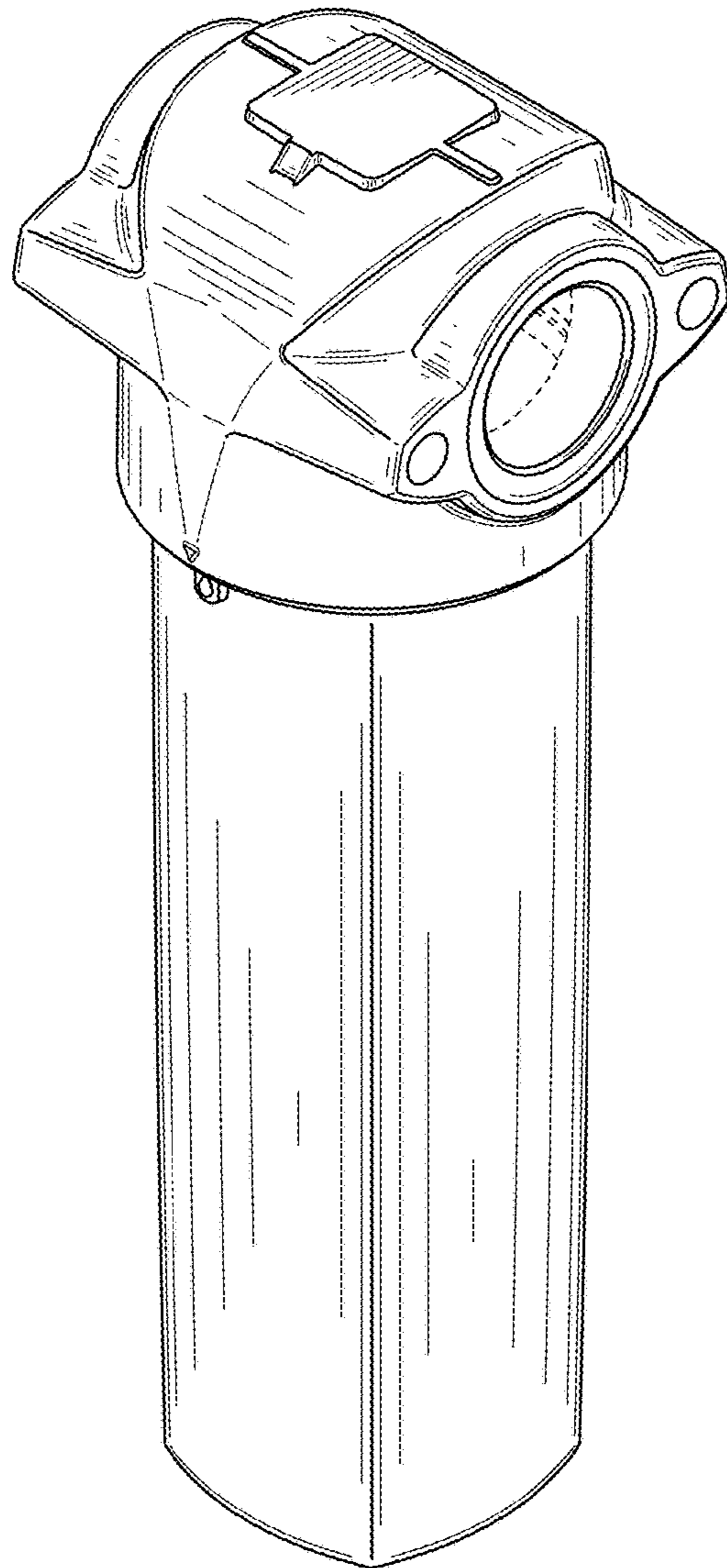

FIG. 1

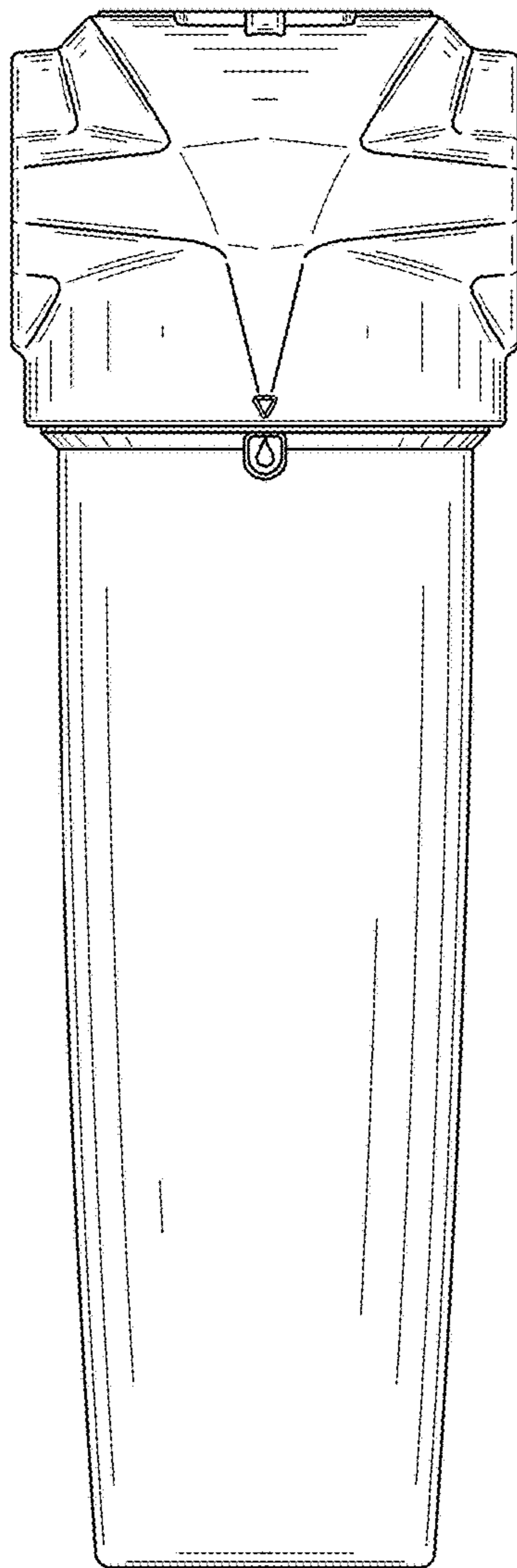

FIG. 2

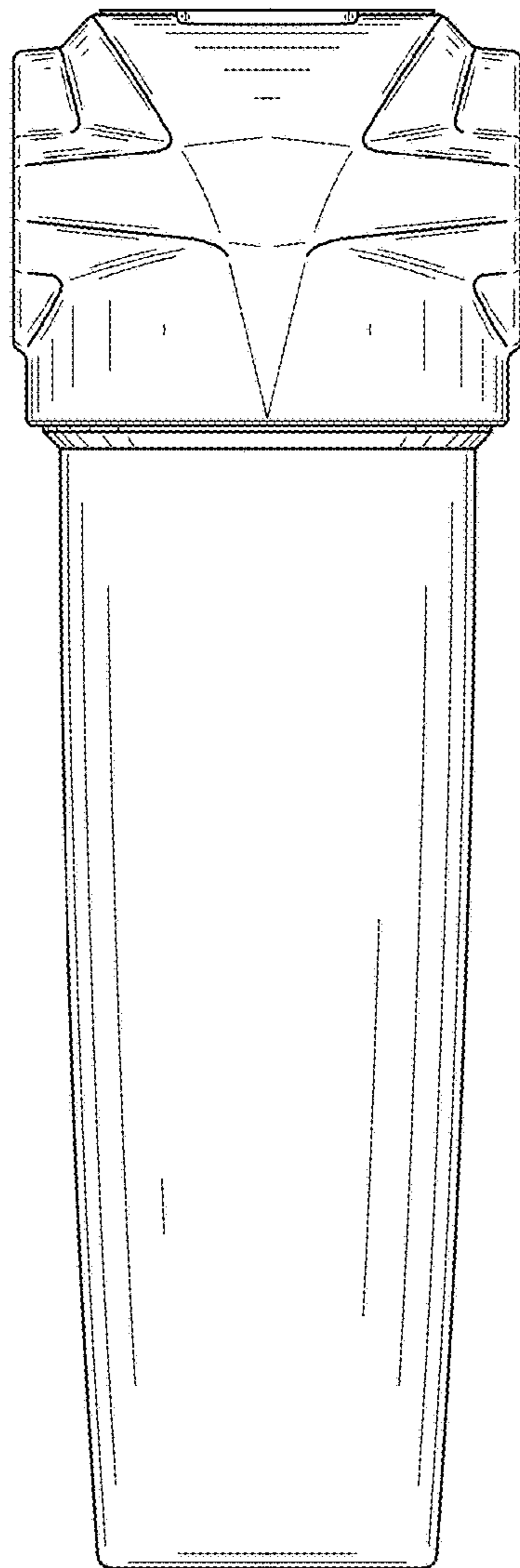

FIG. 3

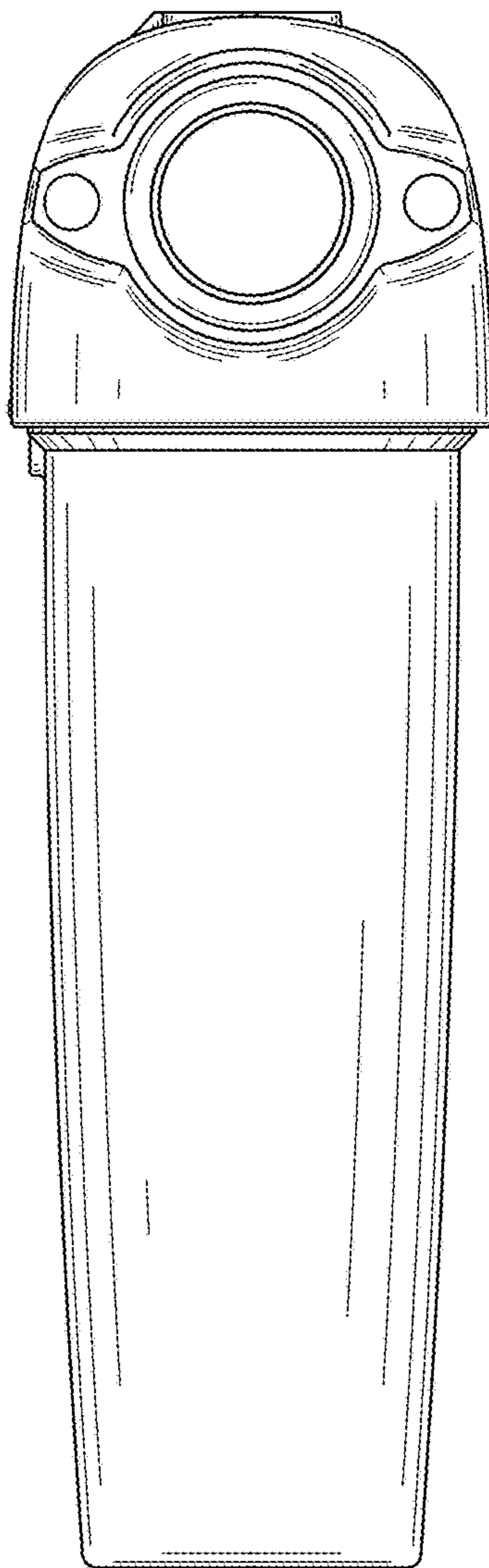

FIG. 4

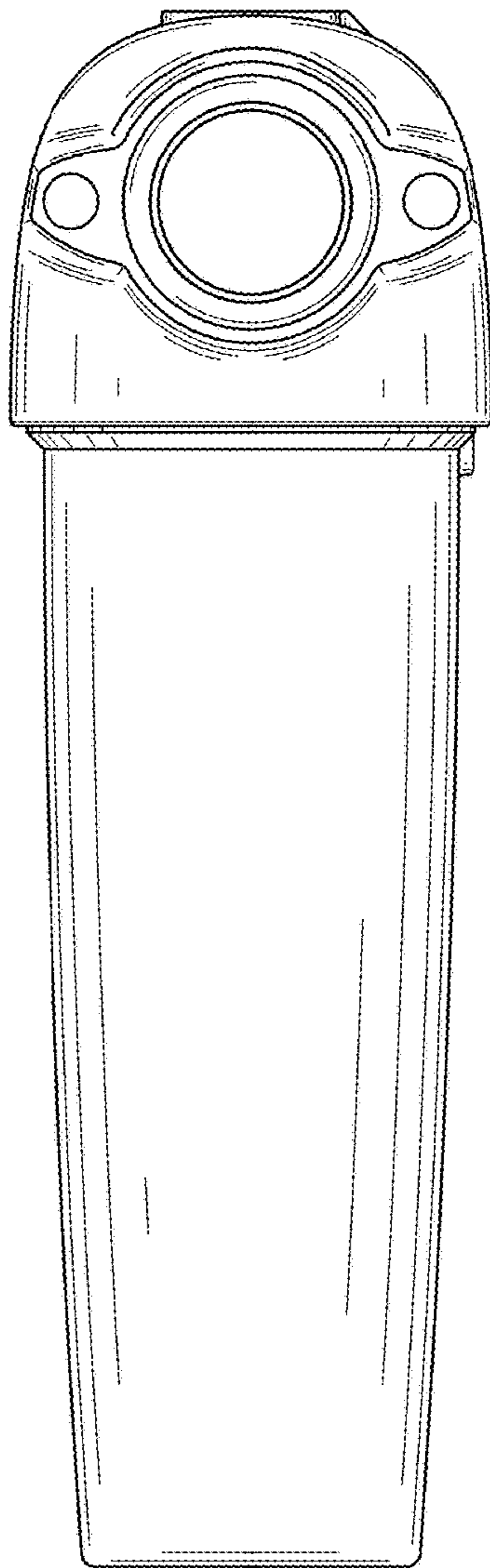

FIG. 5

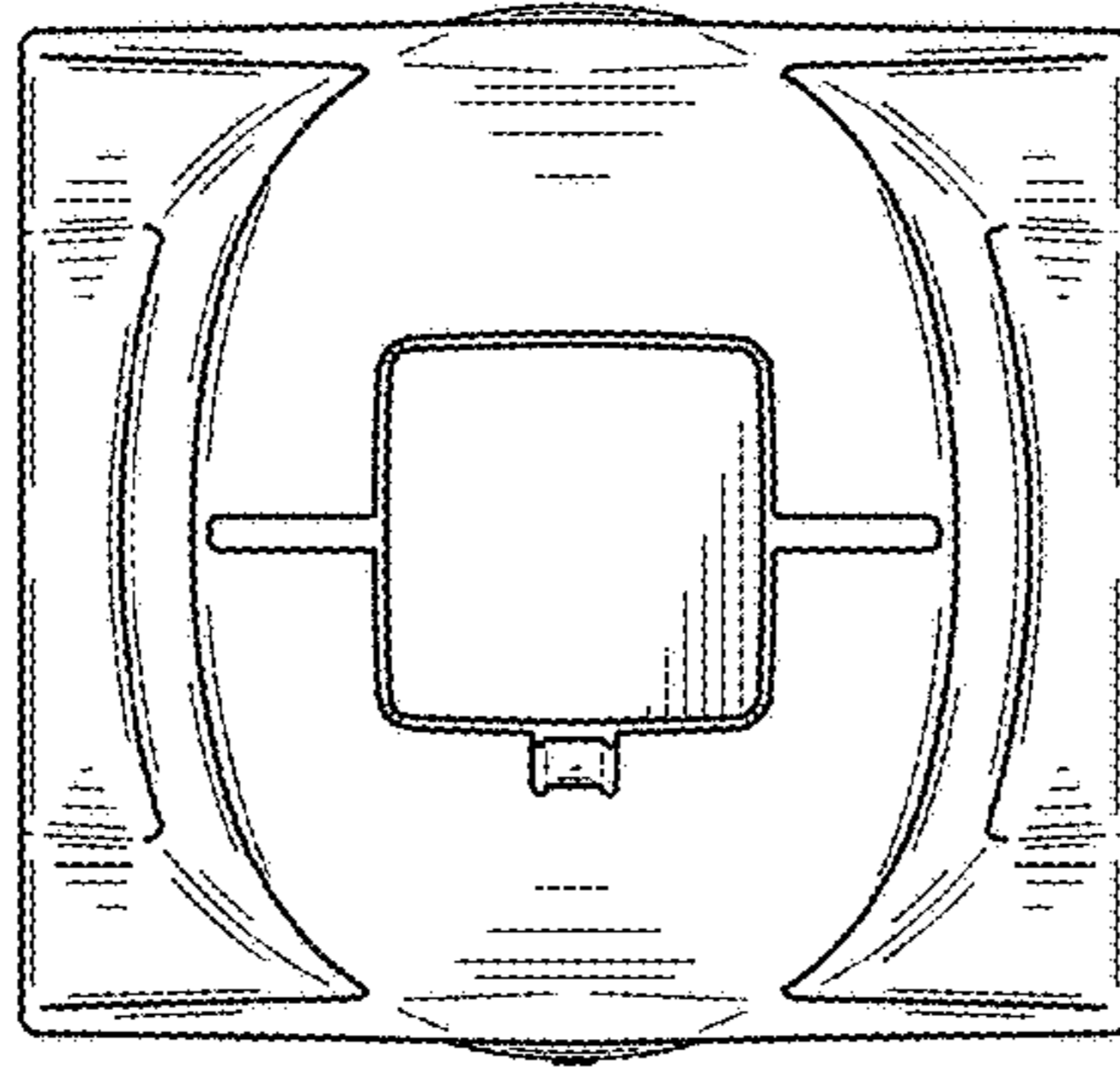

FIG. 6

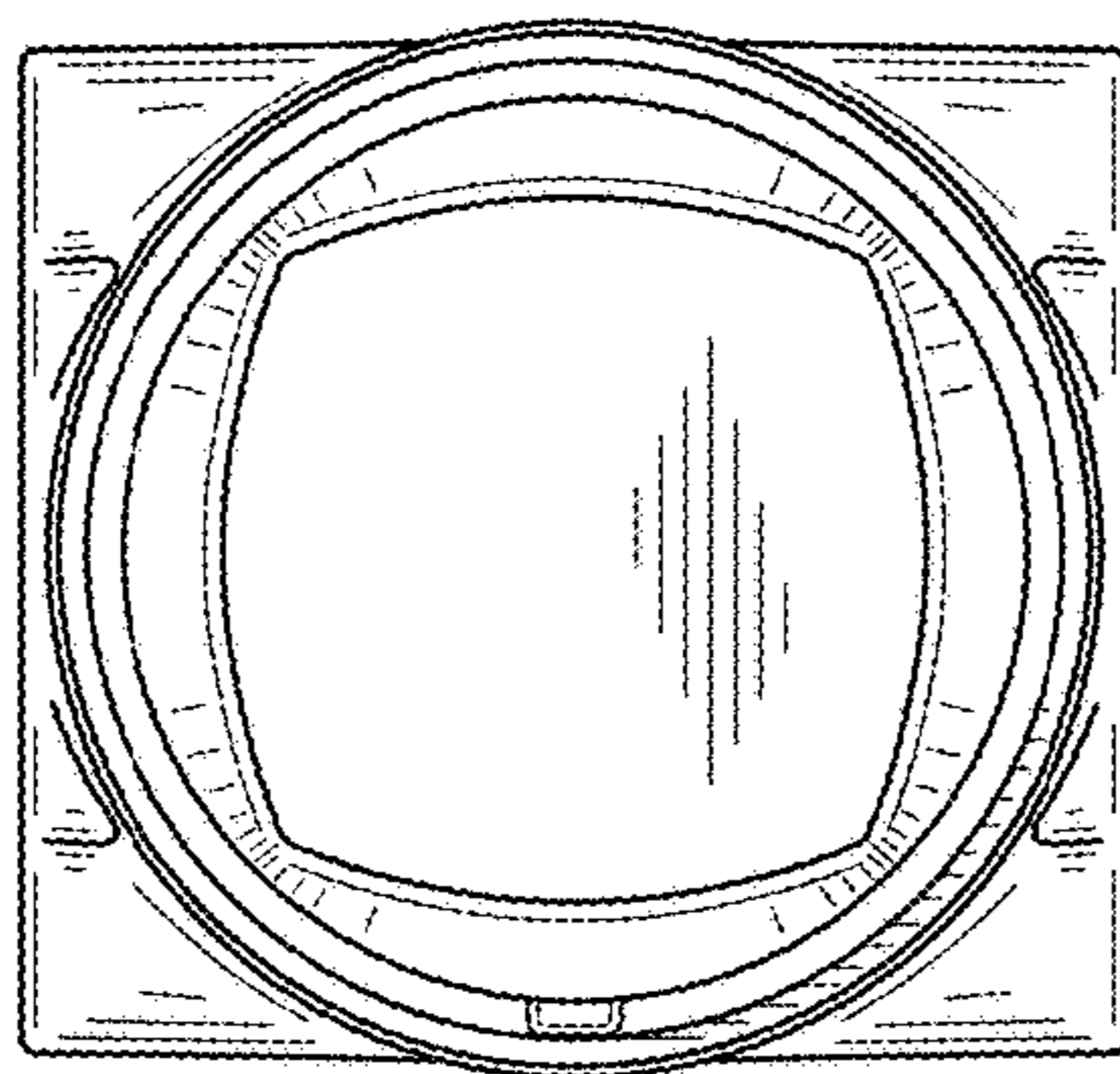

FIG. 7

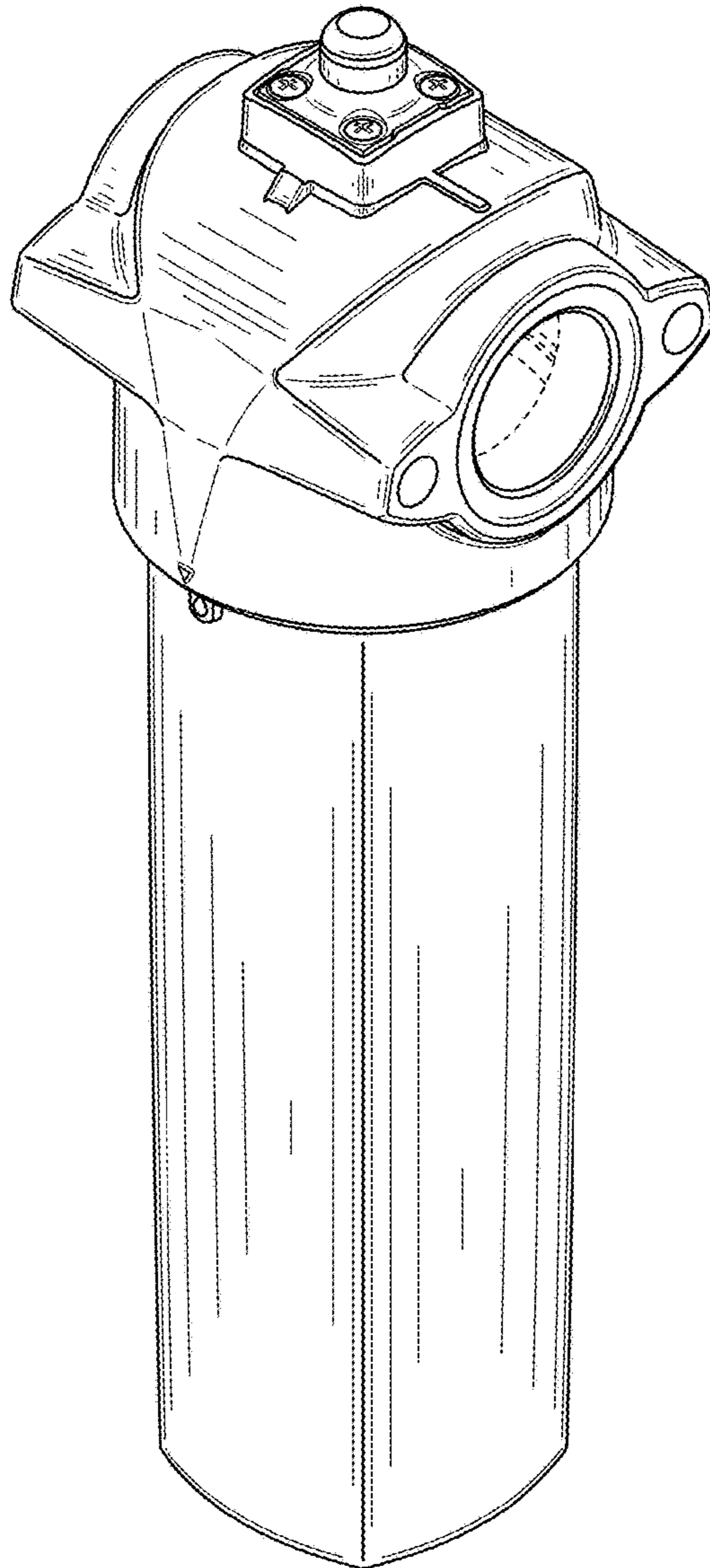

FIG. 8

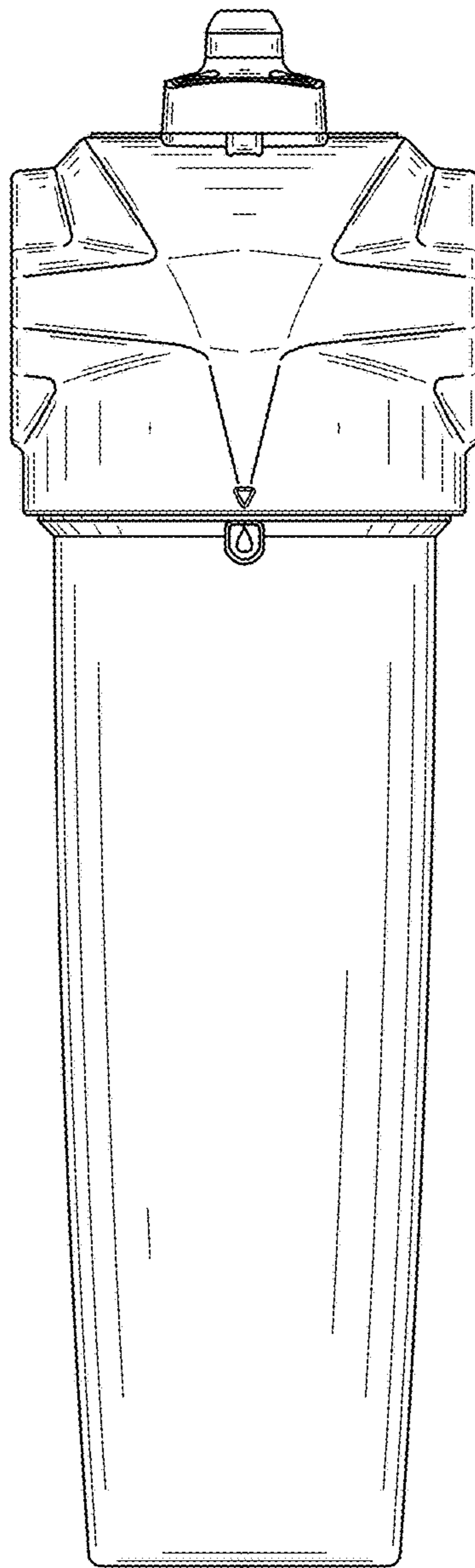

FIG. 9

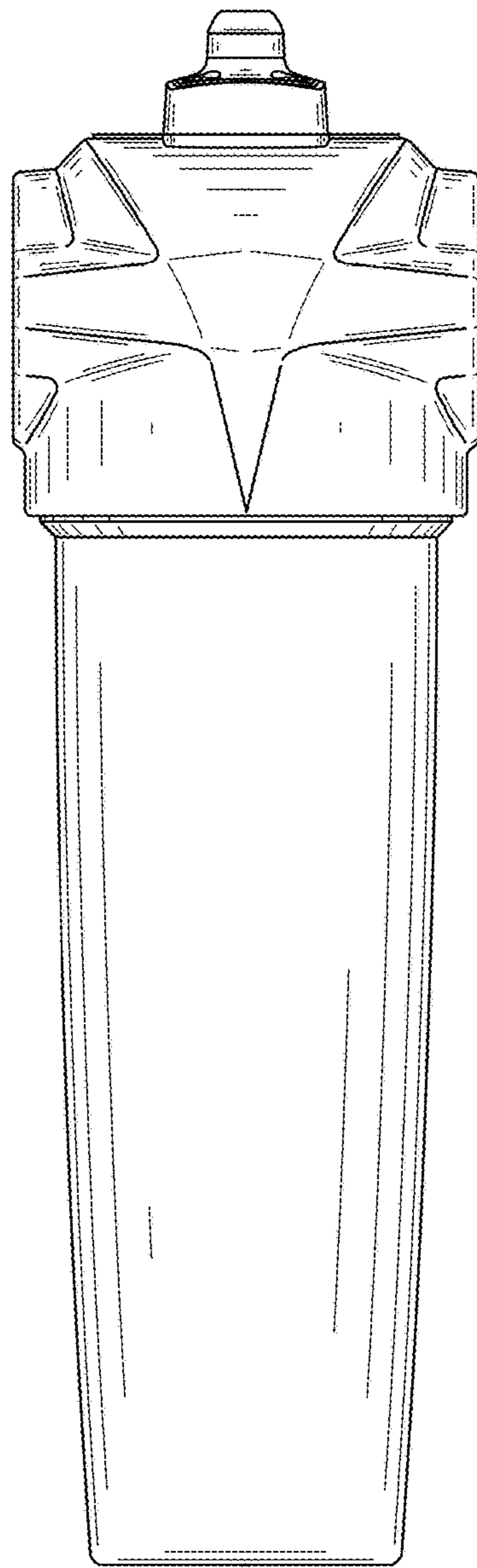

FIG. 10

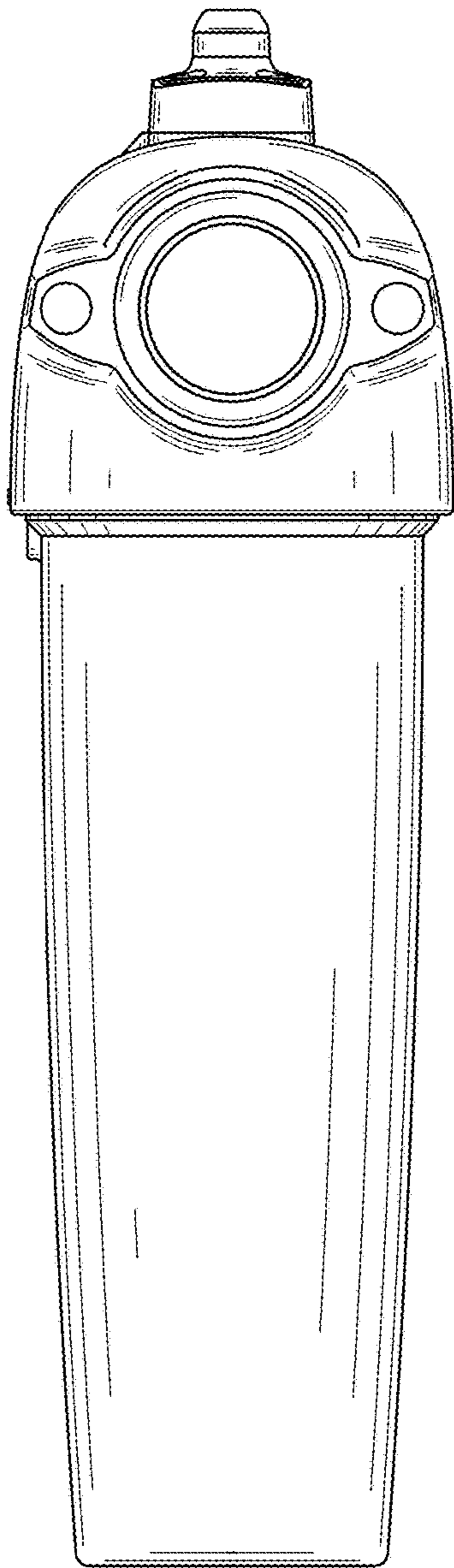

FIG. 11

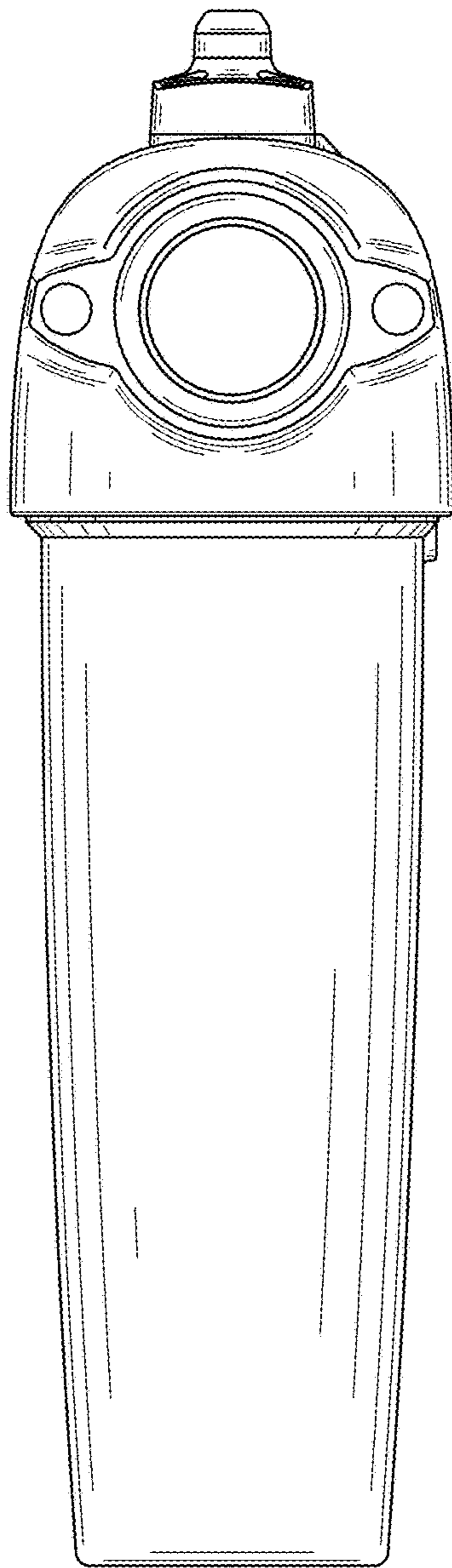

FIG. 12

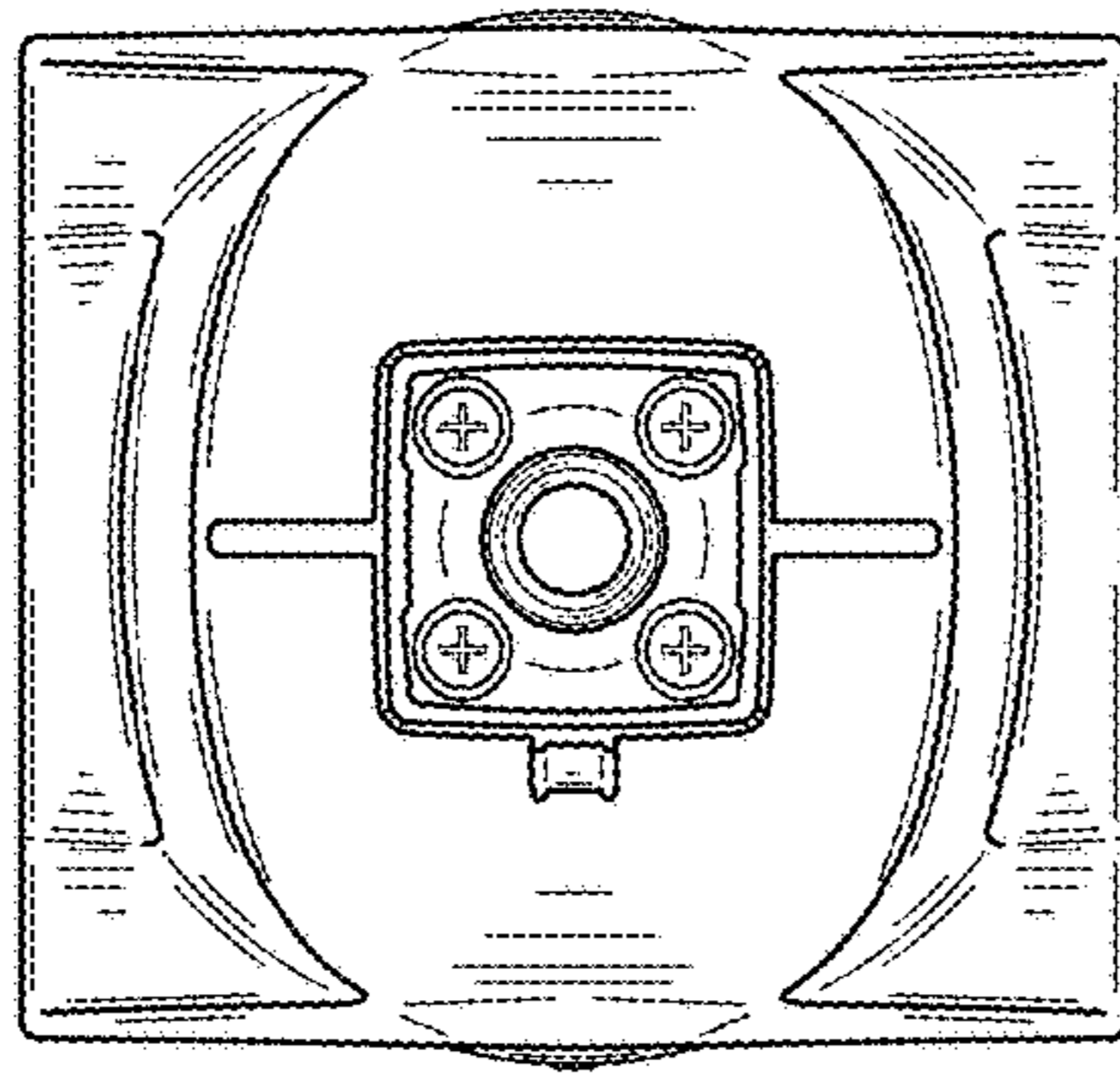

FIG. 13

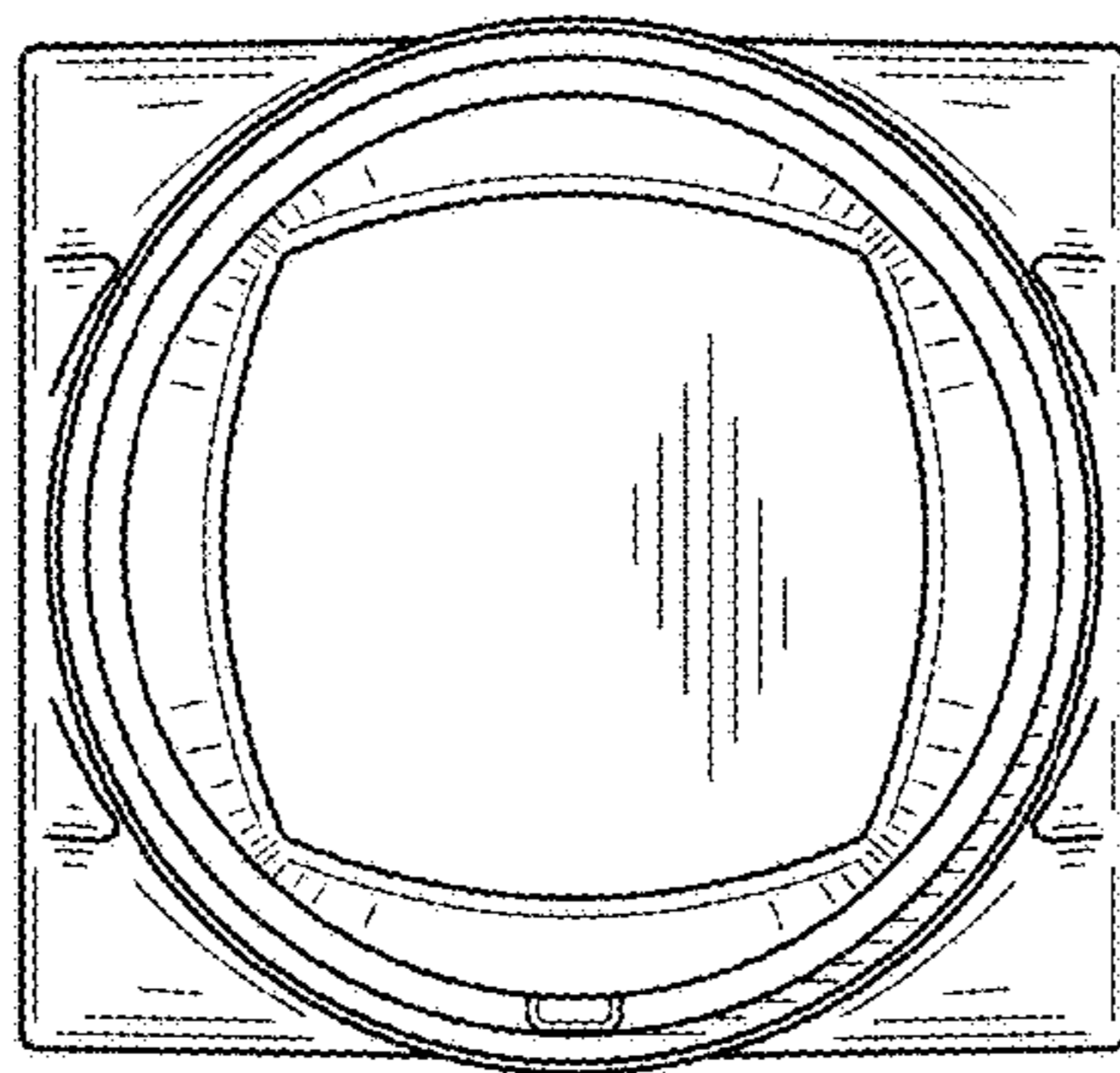

FIG. 14