



US00D847298S

(12) **United States Design Patent** (10) **Patent No.:** **US D847,298 S**
Huang et al. (45) **Date of Patent:** **** Apr. 30, 2019**

(54) **REEL COMPONENT**

(71) Applicants: **Ben Huang**, Huntington Beach, CA (US); **WINN INCORPORATED**, Huntington Beach, CA (US)

(72) Inventors: **Ben Huang**, Huntington Beach, CA (US); **Elmer S. Alfara**, Dana Point, CA (US)

(73) Assignees: **WINN INCORPORATED**, Huntington Beach, CA (US); **Ben Huang**, Huntington Beach, CA (US)

(**) Term: **15 Years**

(21) Appl. No.: **29/604,651**

(22) Filed: **May 18, 2017**

(51) **LOC (11) Cl.** **22-05**

(52) **U.S. Cl.**
USPC **D22/140**

(58) **Field of Classification Search**
USPC D22/137-141, 134, 199; 242/295, 242/316-318, 234-240, 263, 279, 283, 242/310-312, 314, 319, 323
CPC A01K 86/016; A01K 89/033; A47B 95/02; B25G 1/00; B25G 1/102
See application file for complete search history.

(56) **References Cited**

U.S. PATENT DOCUMENTS

5,469,601	A	11/1995	Jackson	
D369,641	S *	5/1996	Asano	D22/140
5,634,859	A	6/1997	Nesbitt	
D579,075	S *	10/2008	Sekimoto	D22/140
7,566,375	B2	7/2009	Huang	
D609,772	S *	2/2010	Tohma	D22/140
D661,774	S *	6/2012	Nago	D22/140
8,201,357	B2	6/2012	Huang	
8,424,236	B2	4/2013	Huang	
8,464,609	B2	6/2013	Shiu et al.	

8,499,487	B2	8/2013	Huang	
D695,379	S *	12/2013	Kano	D22/140
D724,174	S *	3/2015	Nago	D22/140
8,966,809	B2	3/2015	Huang	
D788,256	S *	5/2017	Savakis	D22/140
D802,708	S *	11/2017	Savakis	D22/140
2017/0013816	A1	1/2017	Huang	

(Continued)

FOREIGN PATENT DOCUMENTS

CN	1531983	9/2004
JP	3010205	2/1995
JP	2001-120125	5/2001

(Continued)

OTHER PUBLICATIONS

The Random House College Dictionary, Revised Edition, 1975, p. 1233, definition of skive.
(Continued)

Primary Examiner — Catherine R Oliver-Garcia
(74) *Attorney, Agent, or Firm* — Knobbe, Martens, Olson & Bear, LLP

(57) **CLAIM**

The ornamental design for a reel component, as shown and described.

DESCRIPTION

FIG. 1 is a front bottom perspective view of a reel component showing of the new design;
FIG. 2 is a rear top perspective view thereof;
FIG. 3 is a front elevational view thereof;
FIG. 4 is a rear elevational view thereof;
FIG. 5 is a right elevational view thereof;
FIG. 6 is a left elevational view thereof;
FIG. 7 is a bottom plan view thereof; and,
FIG. 8 is a top plan view thereof.

1 Claim, 8 Drawing Sheets

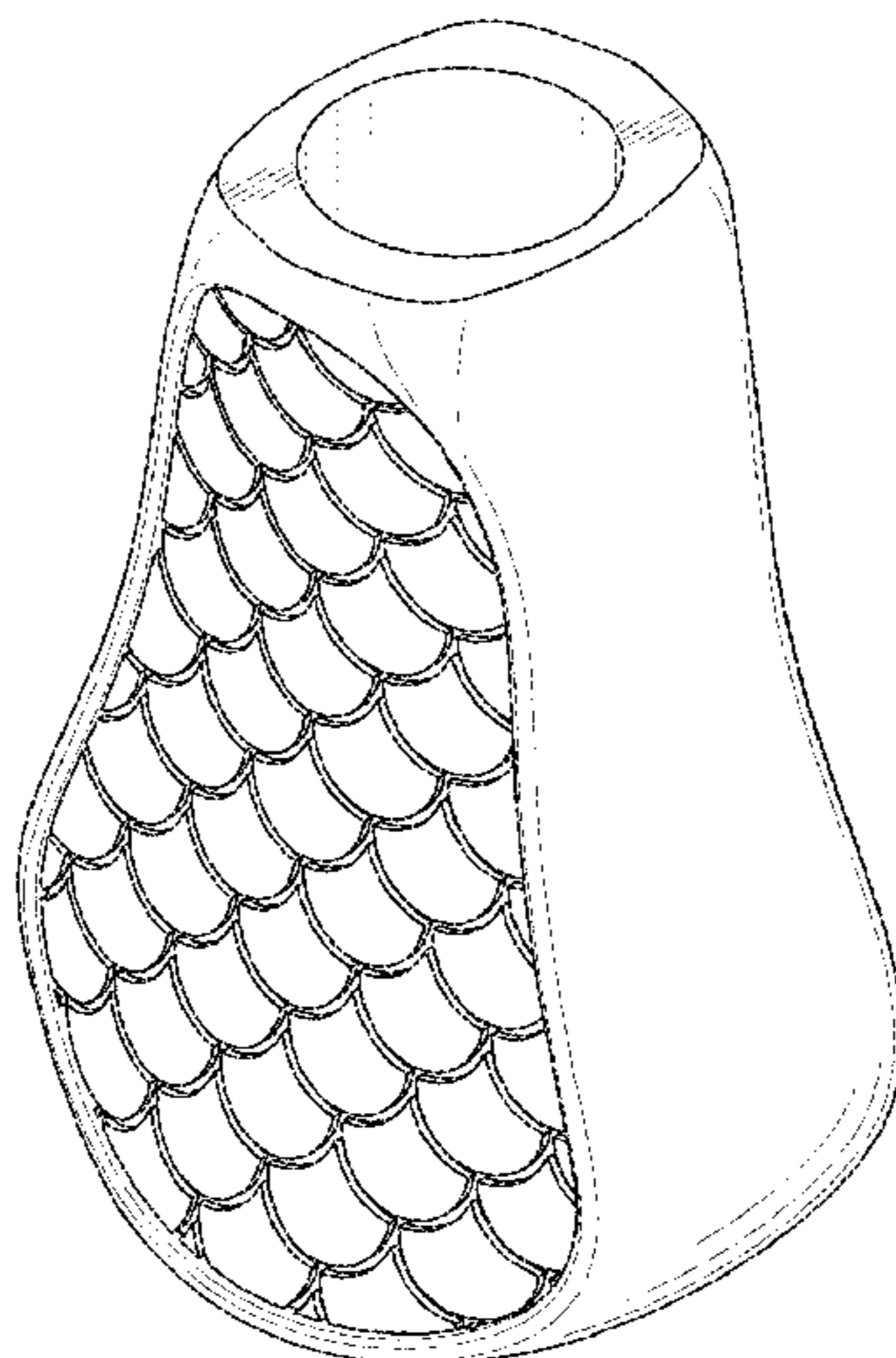

(56)

References Cited

U.S. PATENT DOCUMENTS

2017/0112113 A1 4/2017 Huang
 2018/0317470 A1 11/2018 Huang

FOREIGN PATENT DOCUMENTS

JP	2004-236515	8/2004
JP	2005-177464	7/2005
JP	2008-245645	10/2005
TW	200400843	1/2004

OTHER PUBLICATIONS

- U.S. Appl. No. 09/901,747, filed Jul. 9, 2001, Huang, (U.S. Pub. No. 2001/0046905, published Nov. 29, 2001), abandoned.
- U.S. Appl. No. 10/167,216, filed Jun. 11, 2002, now U.S. Pat. No. 7,137,904, issued Nov. 21, 2006 (014A).
- U.S. Appl. No. 10/348,389, filed Jan. 21, 2003, now U.S. Pat. No. 6,733,401, issued May 11, 2004 (020A).
- U.S. Appl. No. 10/392,480, filed Mar. 18, 2003, now U.S. Pat. No. 6,857,971, issued Feb. 22, 2005 (021A).
- U.S. Appl. No. 10/608,598, filed Jun. 27, 2003, now Abandoned (001A).
- U.S. Appl. No. 10/746,764, filed Dec. 23, 2003 now U.S. Pat. No. 6,843,732, issued Jan. 18, 2005 (039A).
- U.S. Appl. No. 10/785,379, filed Feb. 24, 2004, now U.S. Pat. No. 7,374,498, issued May 20, 2008 (11CP5DV1).
- U.S. Appl. No. 10/827,095, filed Apr. 19, 2004, now U.S. Pat. No. 7,195,568, issued Mar. 27, 2007 (020C1).
- U.S. Appl. No. 10/875,035, filed Jun. 23, 2004 (U.S. Pub. No. 2004-0229710 A1), pending (021CP1).
- U.S. Appl. No. 11/029,328, filed Jan. 5, 2005, now Abandoned (039C1).
- U.S. Appl. No. 11/062,046, filed Feb. 18, 2005, now U.S. Pat. No. 7,470,199, issued Dec. 30, 2008 (021C1).
- U.S. Appl. No. 11/131,832, filed May 18, 2005 (U.S. Pub. No. 2005-0209016 A1), pending (021CP2).
- U.S. Appl. No. 11/172,770, filed Jul. 1, 2005, now U.S. Pat. No. 7,186,189, issued Mar. 6, 2007 (180A).
- U.S. Appl. No. 11/412,196, filed Apr. 25, 2006, (U.S. Pub. No. 2006-0264268 A1), pending (014C1).
- U.S. Appl. No. 11/413,411, filed Apr. 28, 2006, now U.S. Pat. No. 7,344,448 issued Mar. 18, 2008 (020C1C1).
- U.S. Appl. No. 11/416,364, filed May 1, 2006, now U.S. Pat. No. 7,438,646, issued Oct. 21, 2008 (014C2).
- U.S. Appl. No. 11/417,401, filed May 3, 2006, (U.S. Pub. No. 2006-0205530 A1), pending (021C1C2).
- U.S. Appl. No. 11/417,555, filed May 3, 2006, now U.S. Pat. No. 7,404,770, issued Jul. 29, 2008 (021C1C1).
- U.S. Appl. No. 11/417,623, filed May 3, 2006, (U.S. Pub. No. 2007-0169872 A1), pending (208A3).
- U.S. Appl. No. 11/417,643, filed May 3, 2006, now U.S. Pat. No. 7,448,957, issued Nov. 11, 2008 (208A1).
- U.S. Appl. No. 11/417,696, filed May 3, 2006, now U.S. Pat. No. 7,448,958, issued Nov. 11, 2008 (208A2).
- U.S. Appl. No. 11/438,808, filed May 22, 2006, now U.S. Pat. No. 7,347,792, issued May 25, 2008 (207A).
- U.S. Appl. No. 11/682,264, filed Mar. 5, 2007, (U.S. Pub. No. 2007-0149307 A1), pending (180C1).
- U.S. Appl. No. 11/689,452, filed Mar. 21, 2007, (U.S. Pub. No. 2008-0230174 A1), pending (214A).
- U.S. Appl. No. 11/838,670, filed Aug. 14, 2007, (U.S. Pub. No. 2009-0048036 A1), pending (217A).
- U.S. Appl. No. 12/045,639, filed Mar. 10, 2008, now U.S. Pat. No. 7,770,321, issued Aug. 10, 2010.
- U.S. Appl. No. 12/055,289, filed Mar. 25, 2008, (U.S. Pub. No. 2009-0025852 A1), pending (207C1).
- U.S. Appl. No. 12/123,384, filed May 19, 2008, (U.S. Pub. No. 2008-0283178 A1), pending (11CP5DV1C1).
- U.S. Appl. No. 12/425,187, filed Apr. 16, 2009, (U.S. Pub. No. 2009-0258722 A1), abandoned.
- U.S. Appl. No. 12/426,896, filed Apr. 20, 2009, (U.S. Pub. No. 2009-0258721 A1), abandoned.
- U.S. Appl. No. 12/511,033, filed Jul. 28, 2009, (U.S. Pub. No. 2010-0022322 A1), pending.
- U.S. Appl. No. 12/753,669, filed Apr. 2, 2010, (U.S. Pub. 2010-0260987 A1), pending.
- U.S. Appl. No. 12/753,773, filed Apr. 2, 2010, (U.S. Pub. 2010-0281754 A1), pending.
- U.S. Appl. No. 12/753,799, filed Apr. 2, 2010, (U.S. Pub. 2010-0273568 A1), pending.
- U.S. Appl. No. 12/753,804, filed Apr. 2, 2010, (U.S. Pub. 2010-0269626 A1), pending.
- U.S. Appl. No. 12/767,736, filed Apr. 26, 2010, (U.S. Pub. 2011-0065524 A1), pending.
- U.S. Appl. No. 12/848,052, filed Jul. 30, 2010, (U.S. Pub. 2011-0258904 A1), pending.
- U.S. Appl. No. 12/862,673, filed Aug. 24, 2010, (U.S. Pub. 2011-0053704 A1), pending.
- U.S. Appl. No. 12/948,637, filed Nov. 17, 2010, (U.S. Pub. 2011-0113673 A1), pending.
- U.S. Appl. No. 12/960,261, filed Dec. 3, 2010, now U.S. Pat. No. 8,123,627, issued Feb. 28, 2012.
- U.S. Appl. No. 13/208,297, filed Aug. 11, 2011, pending (207C2).
- U.S. Appl. No. 13/403,764, filed Feb. 23, 2012, pending.
- U.S. Appl. No. 13/526,323, filed Jun. 18, 2012, now U.S. Pat. No. 8,499,487, issued Aug. 6, 2013, Huang.
- U.S. Appl. No. 13/750,853, filed Jan. 25, 2013, Huang (U.S. Pub. 2013-0344978, published Dec. 26, 2013), pending.
- U.S. Appl. No. 13/866,911, filed Apr. 19, 2013, now U.S. Pat. No. 8,966,809, issued Mar. 3, 2015, Huang.
- U.S. Appl. No. 13/874,889, filed May 1, 2013, Huang (U.S. Pub. 2014-0041794, published Feb. 13, 2014), pending.
- U.S. Appl. No. 13/916,519, filed Jun. 12, 2013, Huang, (U.S. Pub. 2014-0366327, published Dec. 18, 2014), pending.
- U.S. Appl. No. 13/931,647, filed Jun. 28, 2013, now U.S. Pat. No. 8,734,267, issued May 27, 2014, Huang.
- U.S. Appl. No. 13/958,211, filed Aug. 2, 2013, Huang, abandoned.
- U.S. Appl. No. 13/972,751, filed Aug. 21, 2013, Huang (U.S. Pub. 2014-0090770, published Apr. 3, 2014), pending.
- U.S. Appl. No. 14/137,735, filed Dec. 20, 2013, Huang (U.S. Pub. 2014-0338594, published Nov. 20, 2014), pending.
- U.S. Appl. No. 14/285,390, filed May 22, 2014, Huang (U.S. Pub. 2015-0013109, published Jan. 15, 2015), pending.
- U.S. Appl. No. 14/497,797, filed Sep. 26, 2014, Huang, abandoned.
- U.S. Appl. No. 14/671,745, filed Mar. 27, 2015, Huang, (U.S. Pub. 2015-0273647, published Oct. 1, 2015), pending.
- U.S. Appl. No. 14/726,093, filed May 29, 2015, now U.S. Pat. No. 9,440,128, issued Sep. 13, 2016, Huang.
- U.S. Appl. No. 14/809,072, filed Jul. 24, 2015, Huang, abandoned.
- U.S. Appl. No. 15/188,388, filed Jun. 21, 2016, Huang, abandoned.
- U.S. Appl. No. 15/191,125, filed Jun. 23, 2016, Huang, (U.S. Pub. 2017/0013816, published Jan. 19, 2017), pending.
- U.S. Appl. No. 15/191,453, filed Jun. 23, 2016, Huang, pending.
- U.S. Appl. No. 15/261,758, filed Sep. 9, 2016, Huang, (U.S. Pub. 2017/0216691), pending.
- Design U.S. Appl. No. 29/416,672, filed Mar. 26, 2012, pending.
- Design U.S. Appl. No. 29/436,610, filed Nov. 7, 2012, pending.
- Design U.S. Appl. No. 29/602,815, filed May 3, 2017, pending, Huang.

* cited by examiner

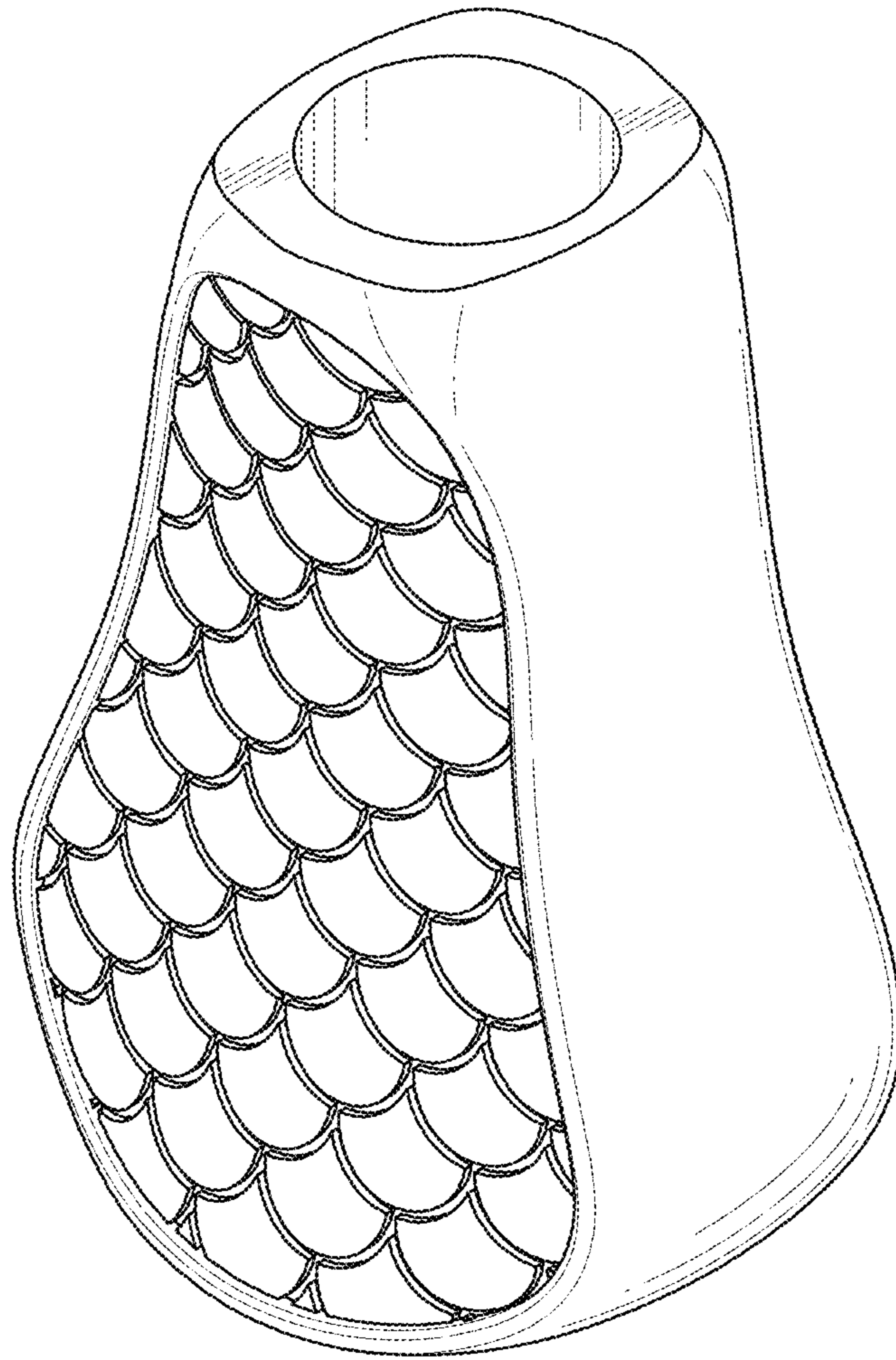

FIG. 1

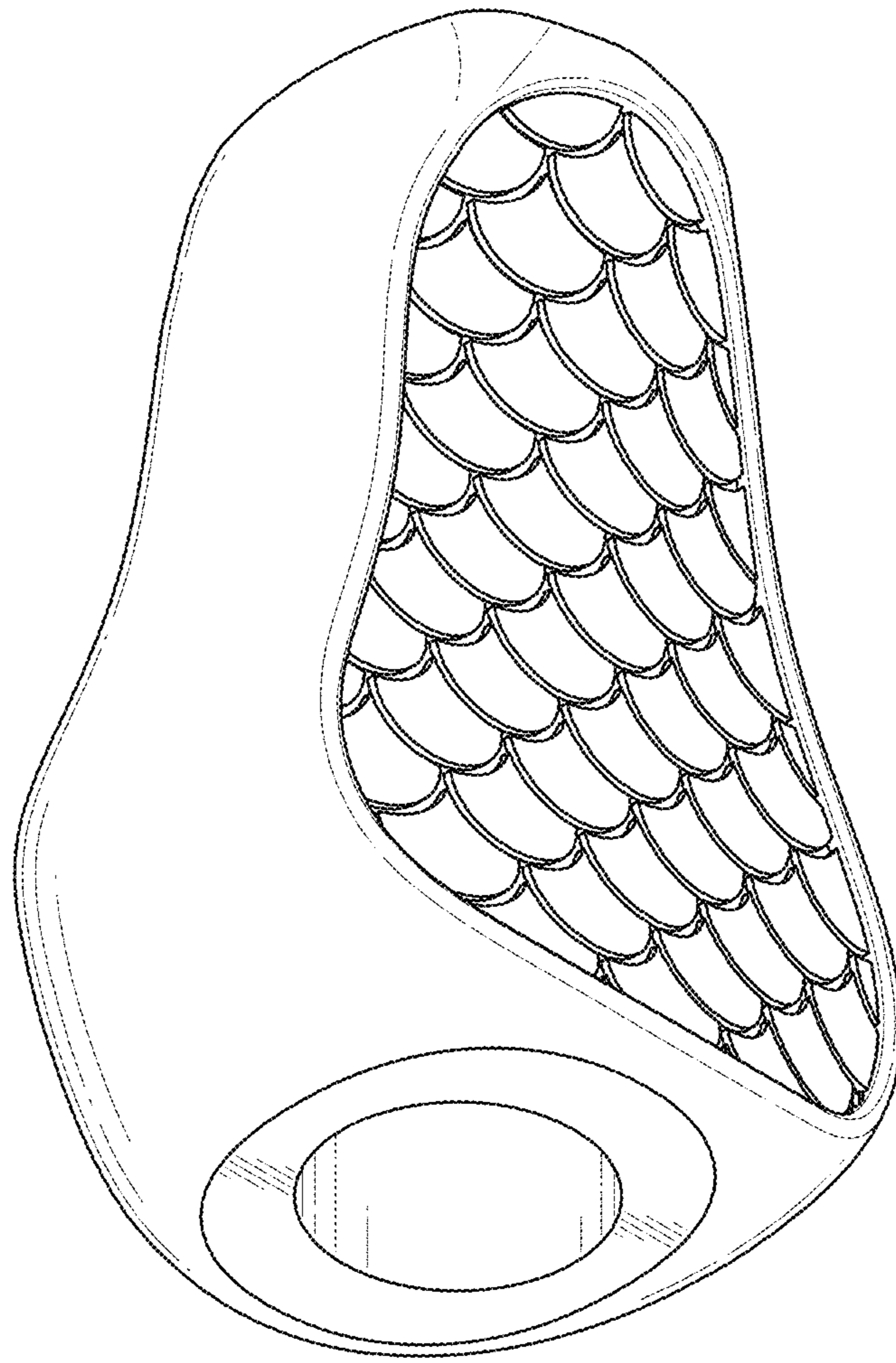

FIG. 2

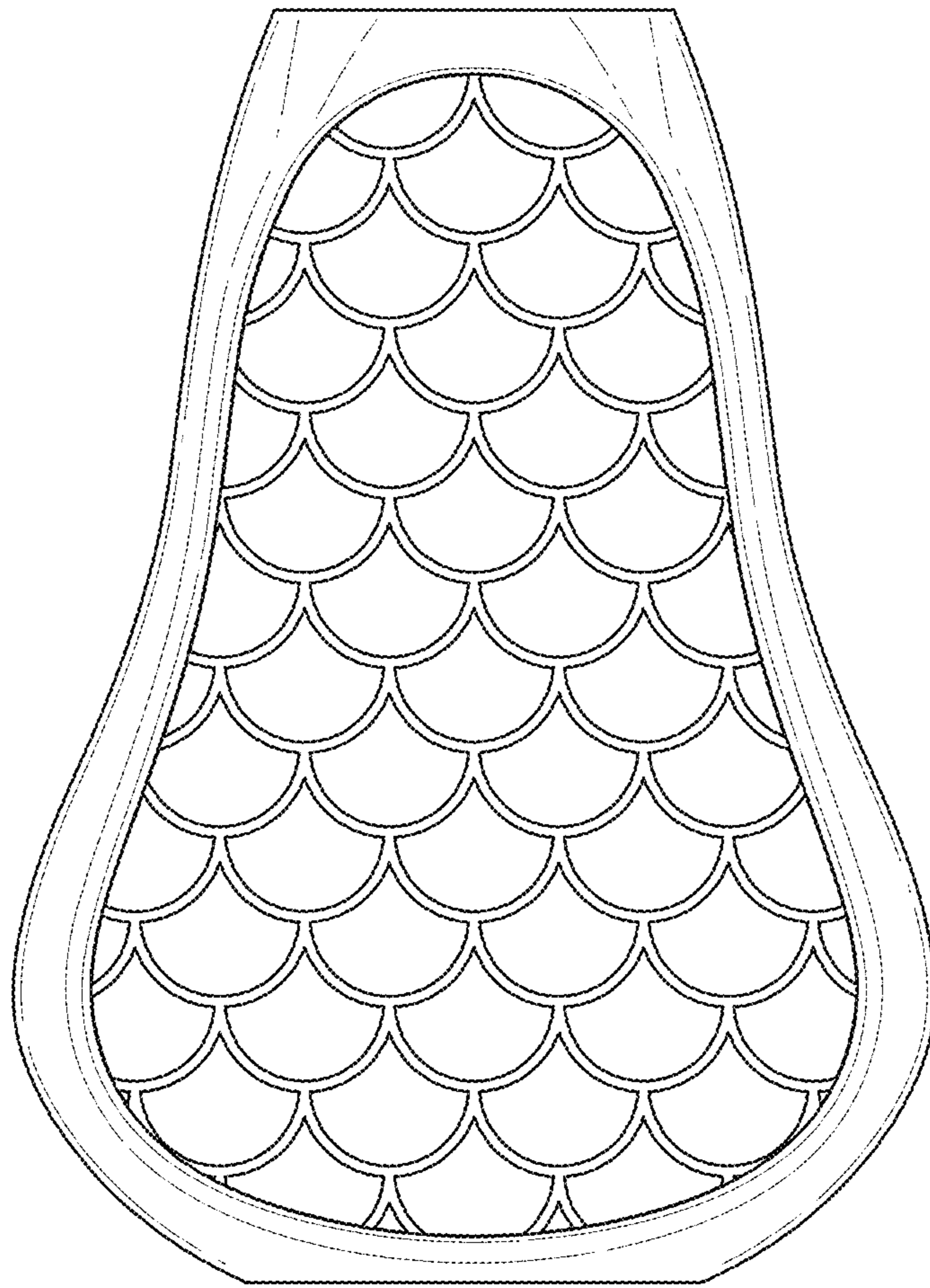

FIG. 3

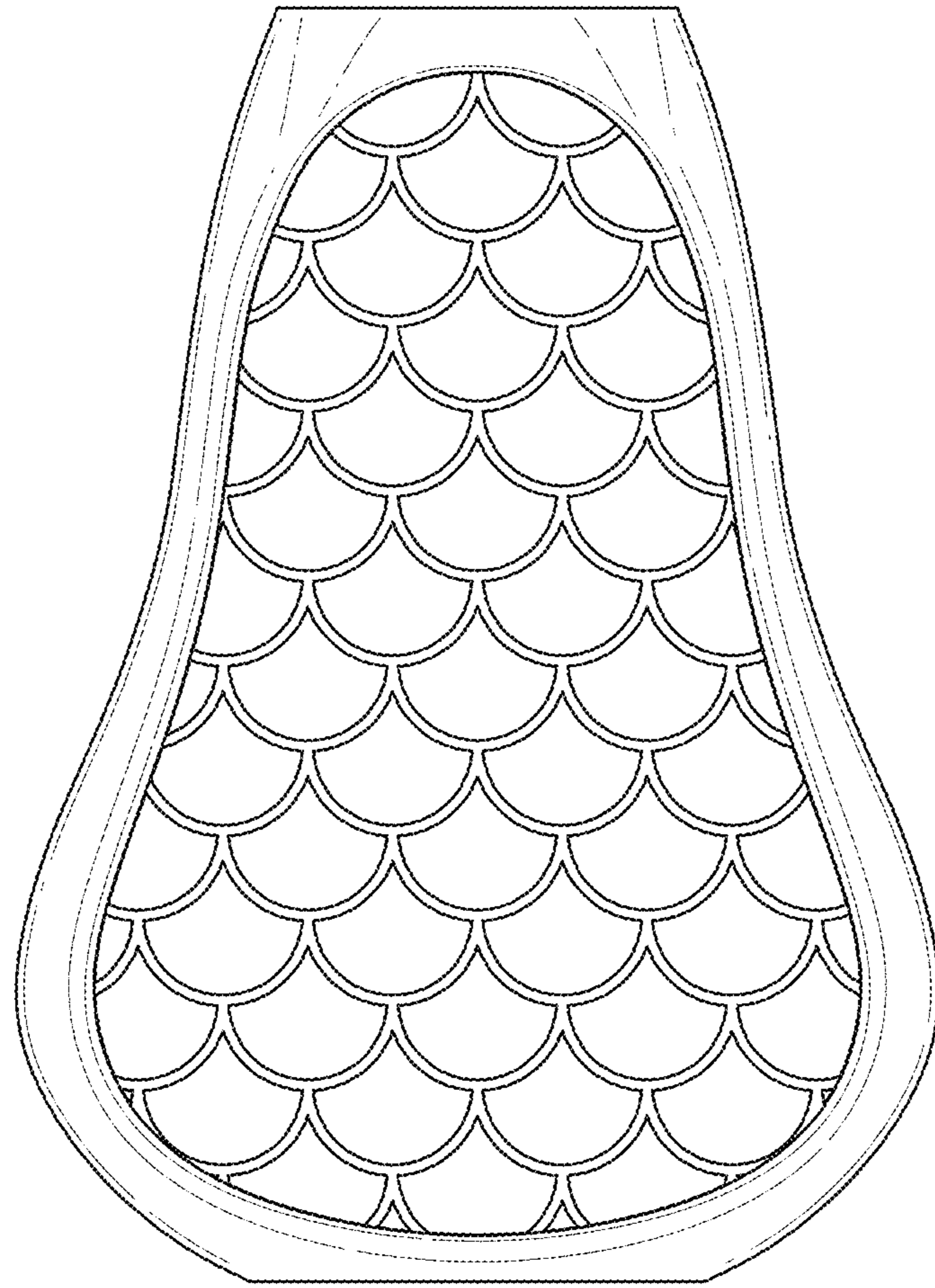

FIG. 4

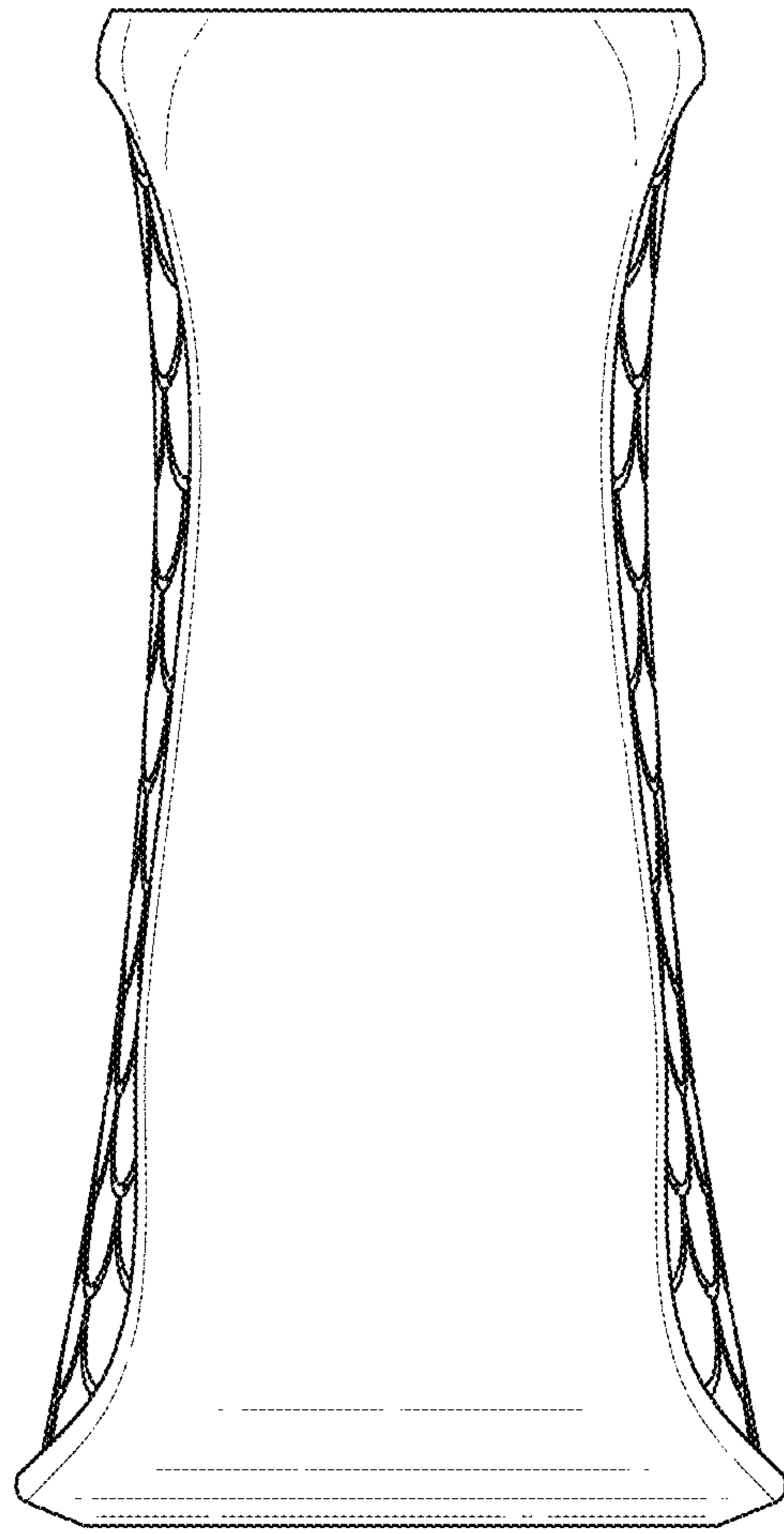

FIG. 5

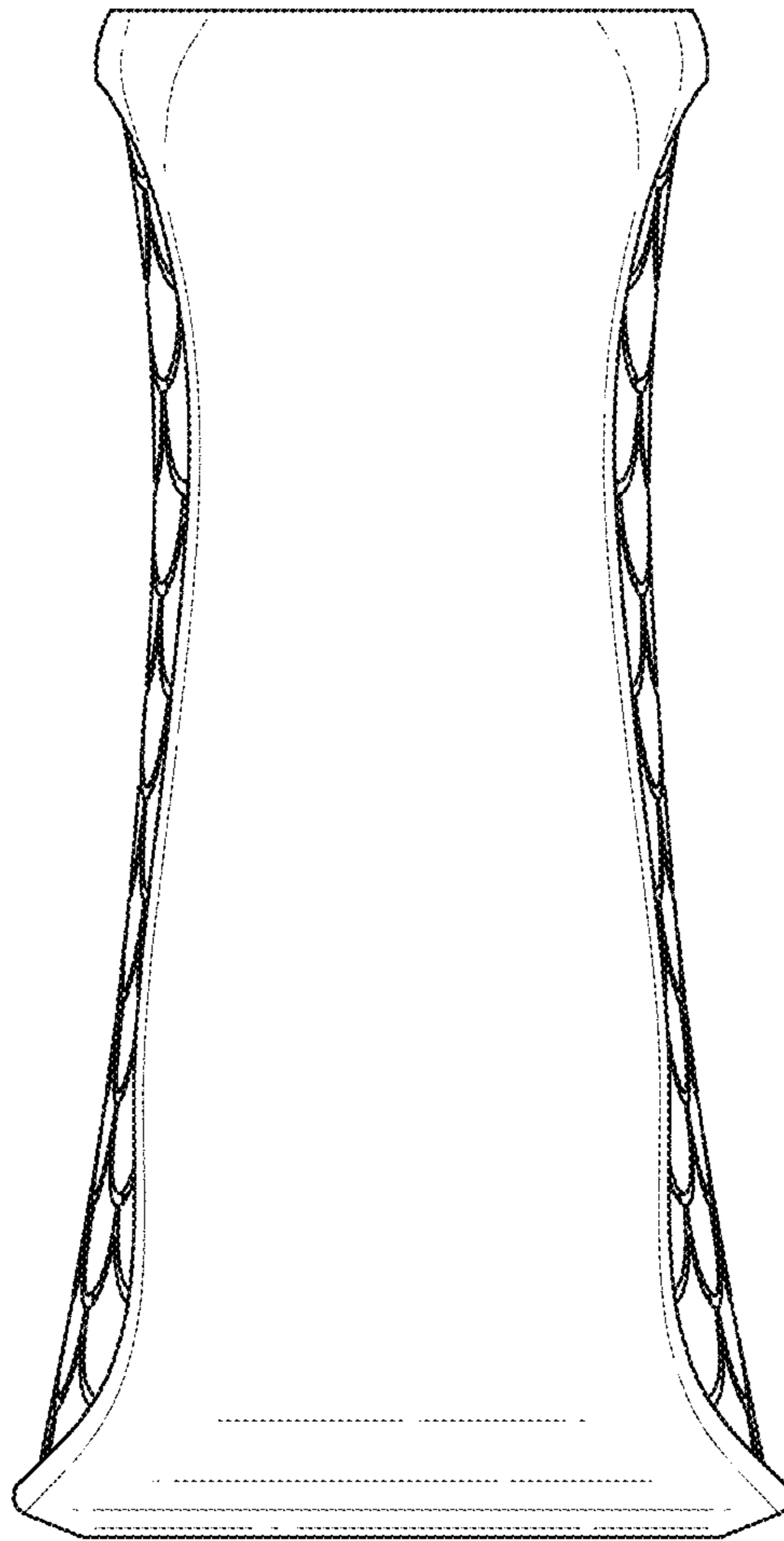

FIG. 6

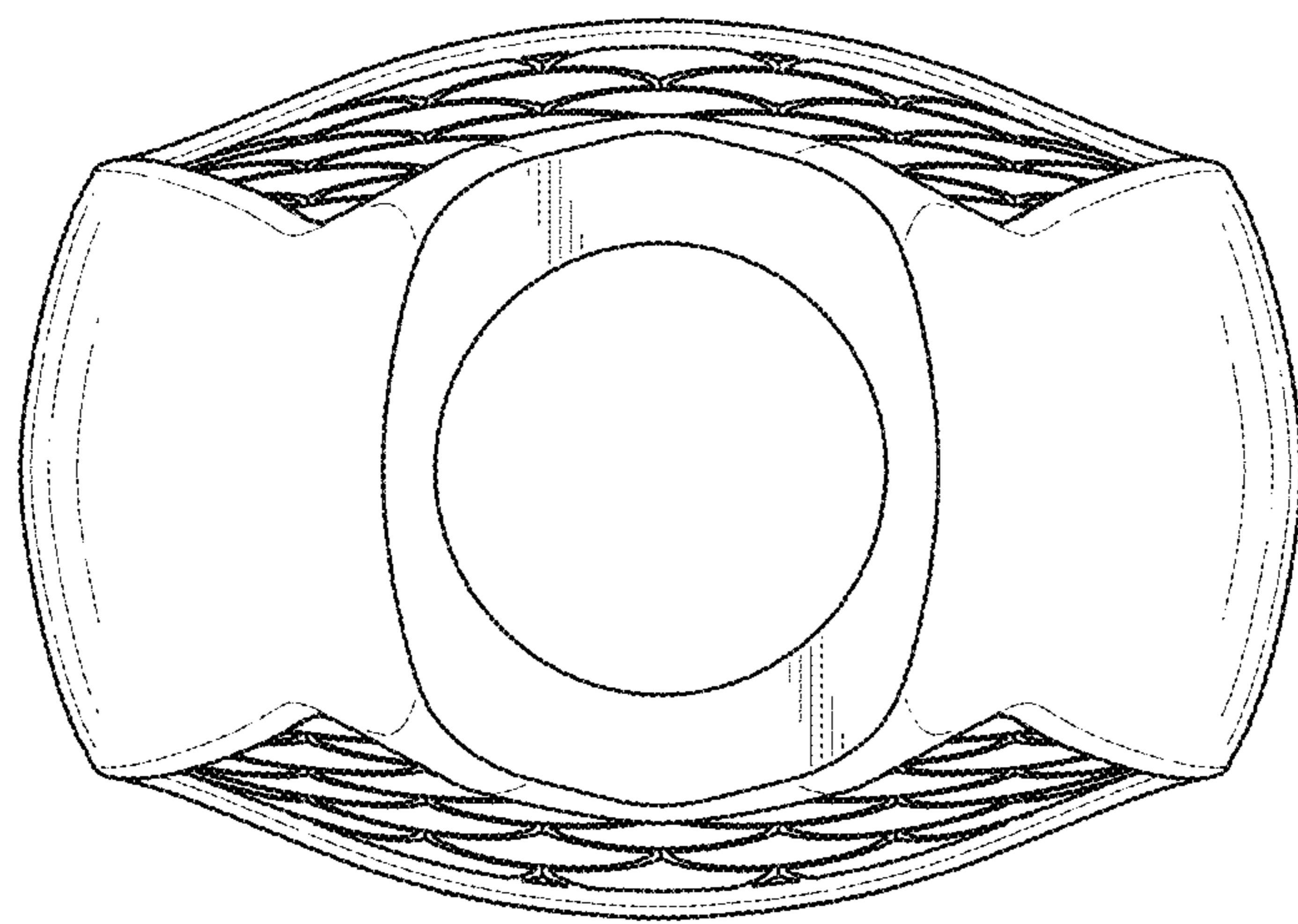

FIG. 7

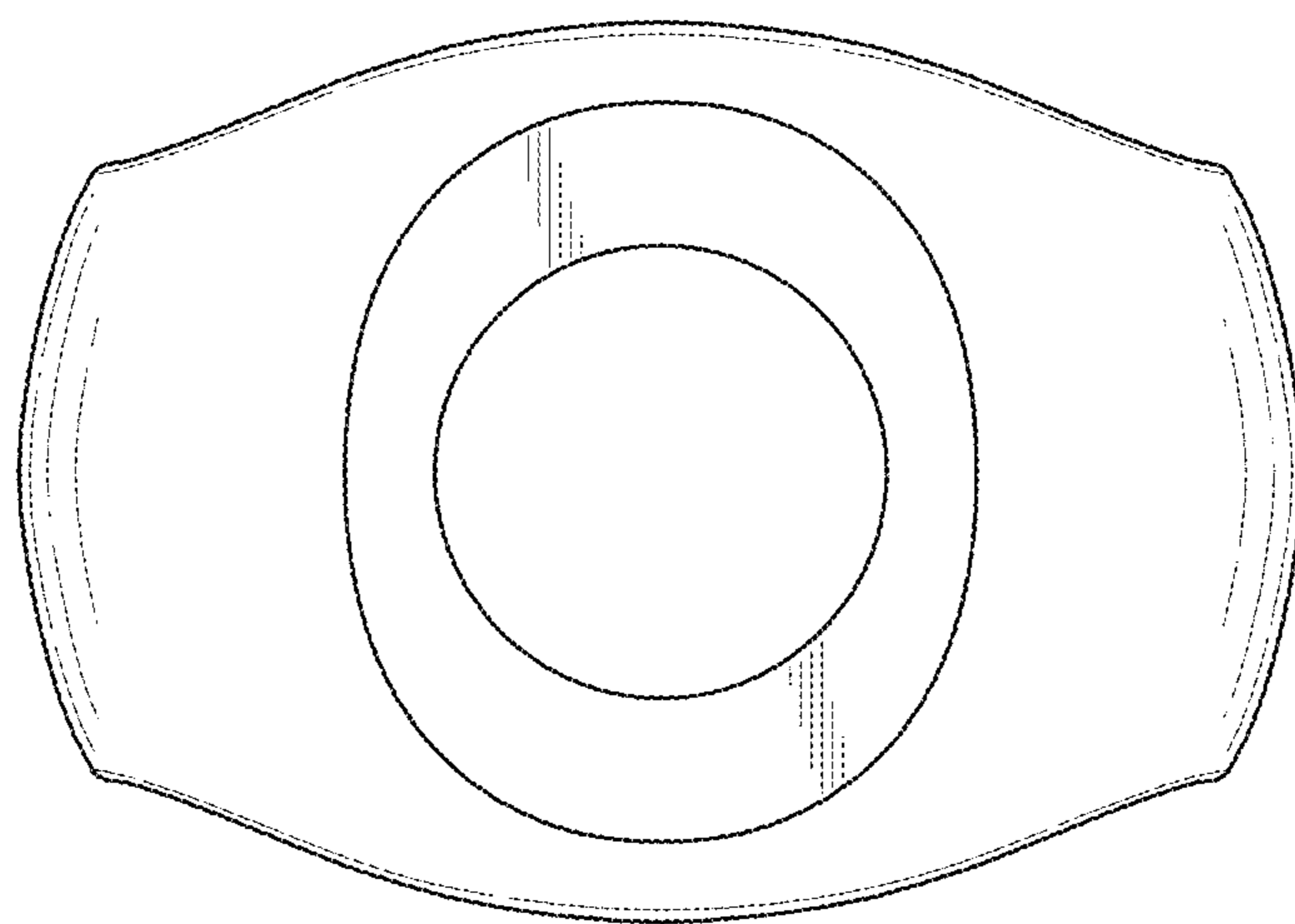

FIG. 8