



US00D847231S

(12) **United States Design Patent**  
**Abe et al.**

(10) **Patent No.:** **US D847,231 S**  
(45) **Date of Patent:** **\*\* Apr. 30, 2019**

(54) **DRILLING TOOL**

(71) Applicant: **SUMITOMO ELECTRIC  
HARDMETAL CORP.**, Itami-shi (JP)

(72) Inventors: **Machiko Abe**, Itami (JP); **Hiroyuki Shimada**, Itami (JP); **Kazuya Yano**, Itami (JP)

(73) Assignee: **SUMITOMO ELECTRIC  
HARDMETAL CORP.**, Itami-shi (JP)

(\*\*) Term: **15 Years**

(21) Appl. No.: **29/550,581**

(22) Filed: **Jan. 5, 2016**

(30) **Foreign Application Priority Data**

Jul. 6, 2015 (JP) ..... 2015-015006  
Jul. 6, 2015 (JP) ..... 2015-015007

(Continued)

(51) **LOC (11) Cl.** ..... **15-09**

(52) **U.S. Cl.**  
USPC ..... **D15/139**

(58) **Field of Classification Search**  
USPC ..... D8/86; D15/131, 132, 138, 139, 140  
(Continued)

(56) **References Cited**

U.S. PATENT DOCUMENTS

4,821,819 A \* 4/1989 Whysong ..... B23K 31/025  
228/122.1  
5,161,859 A \* 11/1992 Larsson ..... B28D 1/188  
299/111

(Continued)

FOREIGN PATENT DOCUMENTS

JP H01-175118 U 12/1989  
JP 2002-036017 A 2/2002

(Continued)

OTHER PUBLICATIONS

Notice in Japanese Design Application No. 2015-015006, dated Nov. 16, 2015.

(Continued)

*Primary Examiner* — Patricia A Palasik  
(74) *Attorney, Agent, or Firm* — Venable LLP; Michael A. Sartori; Laura G. Remus

(57) **CLAIM**

The ornamental design for a drilling tool, as shown and described.

**DESCRIPTION**

FIG. 1 is a front view of a drilling tool of a first embodiment showing our new design,  
FIG. 2 is a rear view thereof;  
FIG. 3 is a top view thereof;  
FIG. 4 is a bottom view thereof;  
FIG. 5 is a right side view thereof;  
FIG. 6 is a left side view thereof;  
FIG. 7 is a perspective view thereof;  
FIG. 8 is an enlarged front view of VIII-VIII portion of FIG. 1,  
FIG. 9 is an enlarged top view of VIII-VIII portion of FIG. 1,  
FIG. 10 is an enlarged right side view of VIII-VIII portion of FIG. 1,  
FIG. 11 is an enlarged first perspective view of VIII-VIII portion of FIG. 1,  
FIG. 12 is an enlarged second perspective view of VIII-VIII portion of FIG. 1,  
FIG. 13 is a front view of a drilling tool of a second embodiment showing our new design,  
FIG. 14 is a rear view thereof;  
FIG. 15 is a top view thereof;  
FIG. 16 is a bottom view thereof;  
FIG. 17 is a right side view thereof;  
FIG. 18 is a left side view thereof;  
FIG. 19 is a perspective view thereof;  
FIG. 20 is an enlarged front view of XX-XX portion of FIG. 13,

(Continued)

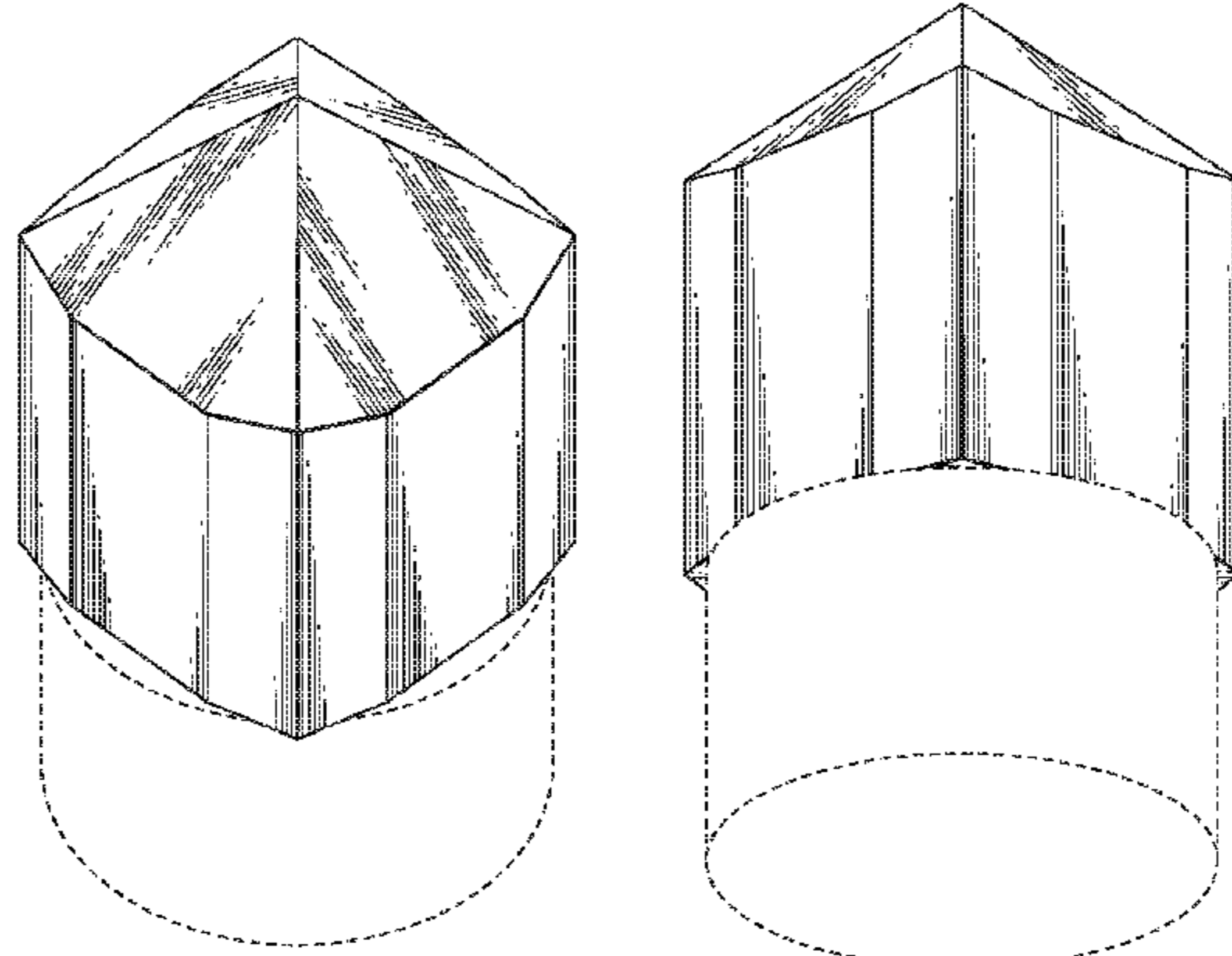

FIG. 21 is an enlarged top view of XX-XX portion of FIG. 13,  
 FIG. 22 is an enlarged right side view of XX-XX portion of FIG. 13,  
 FIG. 23 is an enlarged first perspective view of XX-XX portion of FIG. 13,  
 FIG. 24 is an enlarged second perspective view of XX-XX portion of FIG. 13,  
 FIG. 25 is an enlarged front view of XXV-XXV portion of FIG. 20; and,  
 FIG. 26 is an enlarged right side view of XXV-XXV portion of FIG. 20.  
 The broken lines shown in the drawings represent portions of the drilling tool that form no part of the claimed design.

**1 Claim, 18 Drawing Sheets**

(30) **Foreign Application Priority Data**

Jul. 6, 2015 (JP) ..... 2015-015008  
 Jul. 6, 2015 (JP) ..... 2015-015009

(58) **Field of Classification Search**

CPC ... B23K 31/025; B23K 35/0222; E21B 10/56;  
 E21C 35/183; E21C 2035/1806  
 See application file for complete search history.

(56) **References Cited**

U.S. PATENT DOCUMENTS

5,172,779 A \* 12/1992 Siracki ..... E21B 10/52  
 175/420.1  
 5,417,475 A \* 5/1995 Graham ..... E21B 10/46  
 175/427  
 D371,374 S \* 7/1996 Fischer ..... D15/139

5,837,071 A \* 11/1998 Andersson ..... E21C 35/183  
 148/528  
 6,196,636 B1 \* 3/2001 Mills ..... E21C 35/183  
 299/104  
 6,758,530 B2 \* 7/2004 Sollami ..... B28D 1/188  
 299/104  
 D627,804 S \* 11/2010 Fader ..... D15/139  
 8,007,049 B2 \* 8/2011 Fader ..... B28D 1/186  
 299/105  
 8,701,799 B2 \* 4/2014 Hall ..... B23P 6/00  
 175/432  
 8,950,517 B2 \* 2/2015 Hall ..... E21B 4/14  
 175/385  
 9,200,483 B2 \* 12/2015 Gavia ..... E21B 10/55  
 9,316,058 B2 \* 4/2016 Bilen ..... E21B 10/55  
 9,610,555 B2 \* 4/2017 Mukhopadhyay ..... B01J 3/065  
 9,683,410 B2 \* 6/2017 Zhang ..... E21B 10/567  
 9,739,097 B2 \* 8/2017 Zhang ..... E21B 10/573

FOREIGN PATENT DOCUMENTS

JP 2005-022102 A 1/2005  
 JP 2012-011475 A 1/2012  
 JP D1522840 4/2015  
 TW D156297 10/2013

OTHER PUBLICATIONS

Notice in Japanese Design Application No. 2015-015007, dated Nov. 16, 2015.  
 Notice in Japanese Design Application No. 2015-015008, dated Nov. 16, 2015.  
 Notice in Japanese Design Application No. 2015-015009, dated Nov. 16, 2015.  
 Notice of Allowance in Taiwanese Design Application No. 105300043, dated May 30, 2016.  
 Notice of Allowance in Taiwanese Design Application No. 105300043D01, dated May 30, 2016.  
 Notice of Allowance in Taiwanese Design Application No. 105300043D02, dated May 30, 2016.

\* cited by examiner

FIG.1

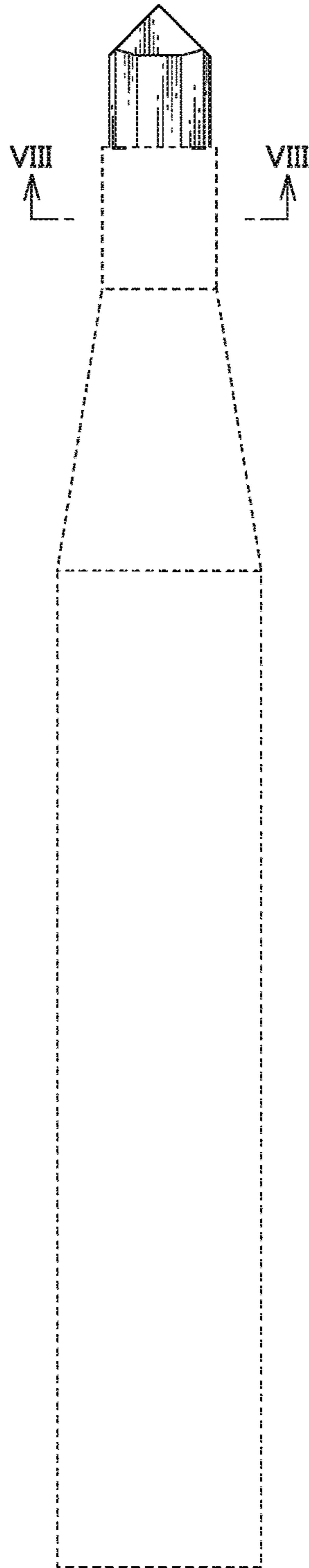

FIG.2

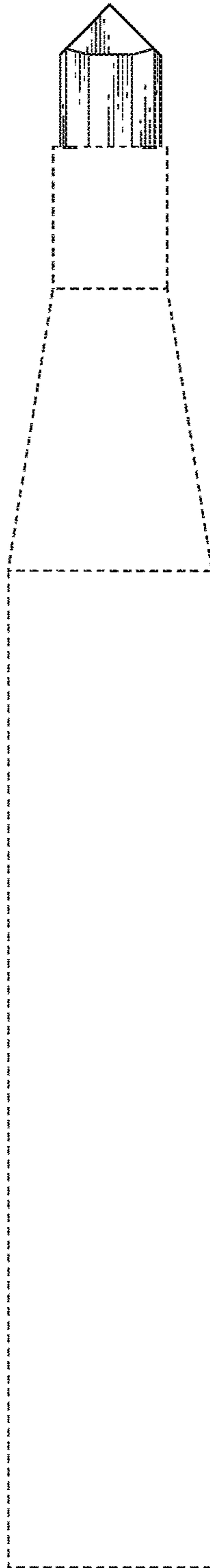

FIG.3

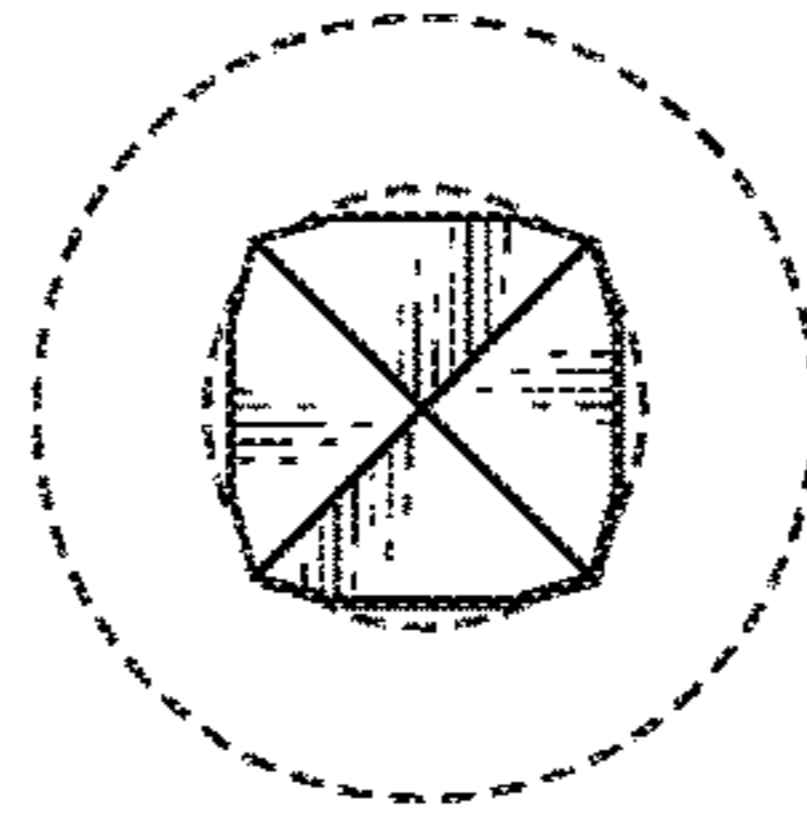

FIG.4

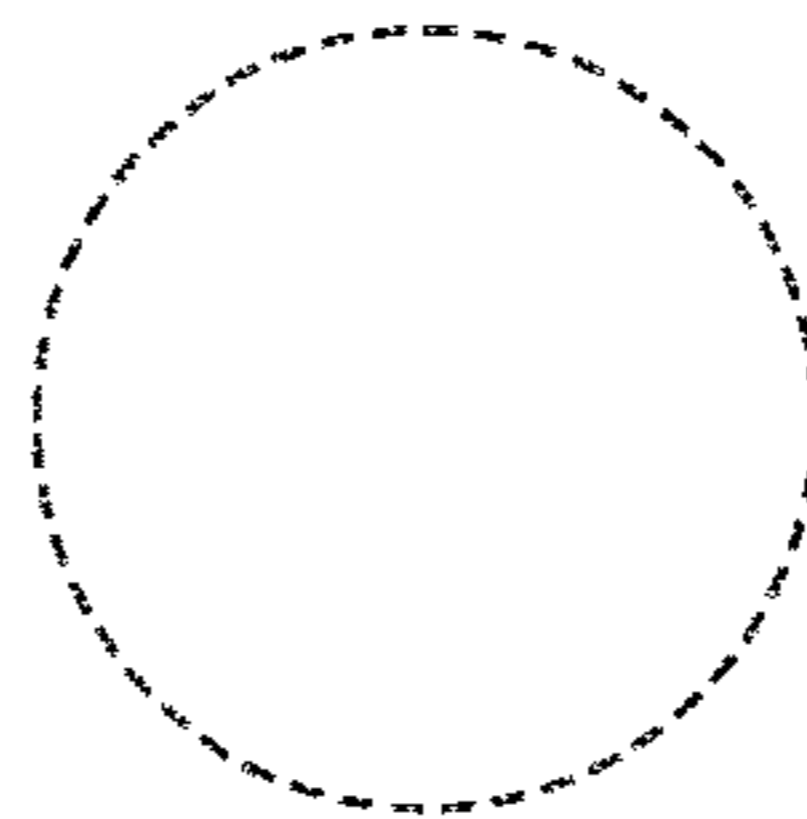

FIG.5

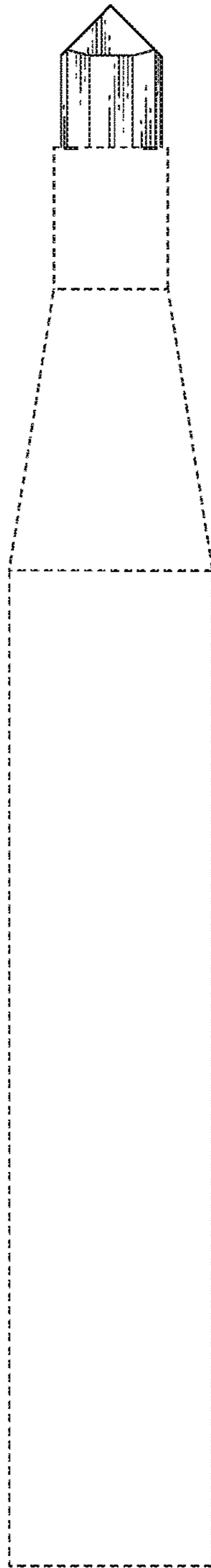

FIG.6

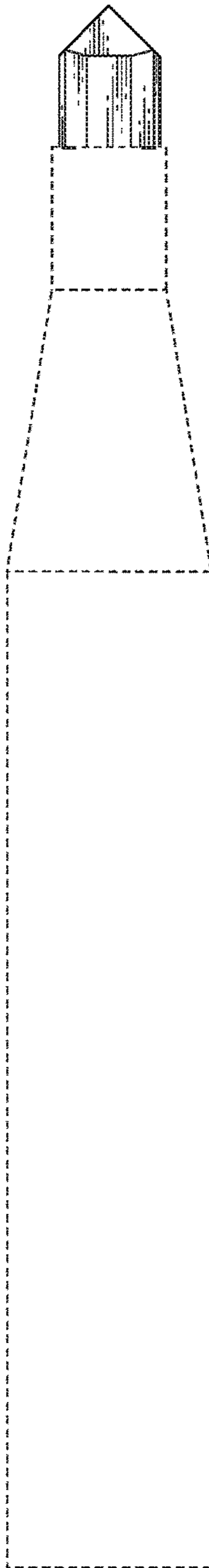

FIG.7

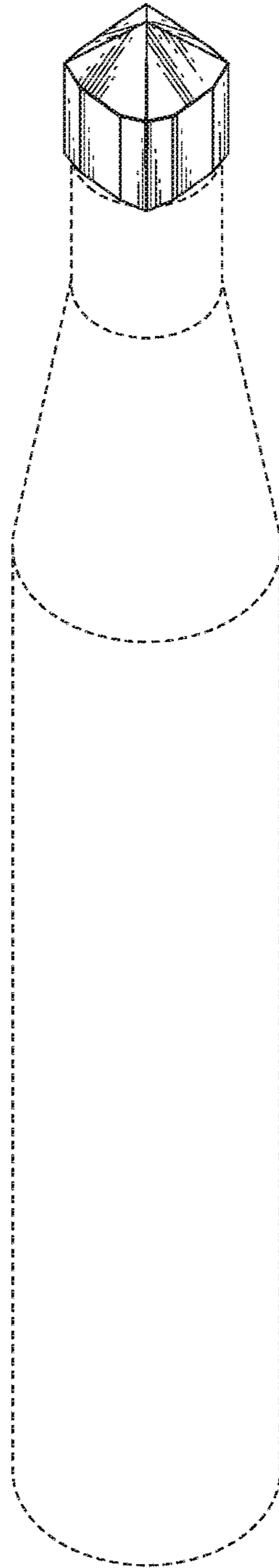



FIG.8

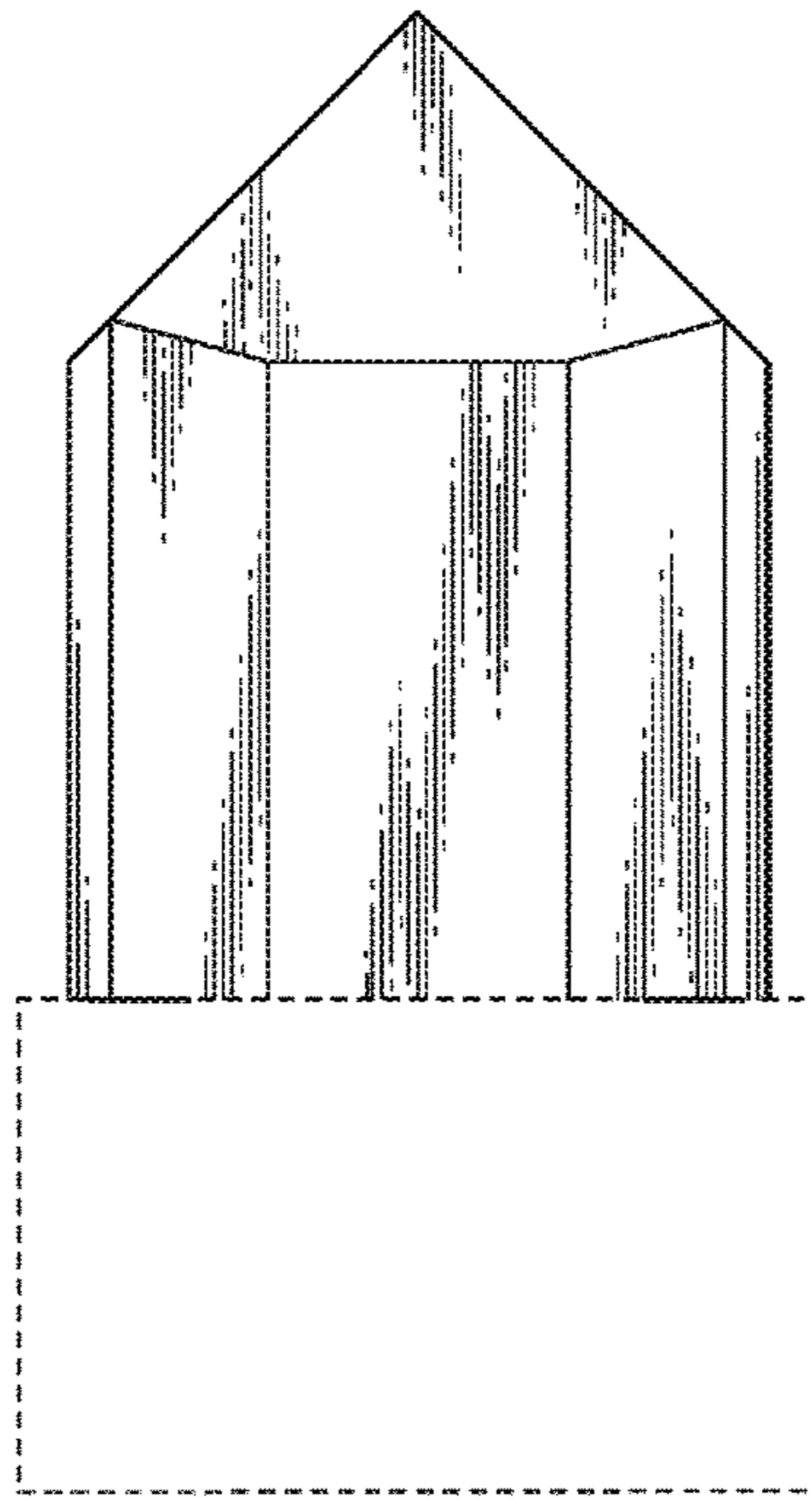

FIG.9

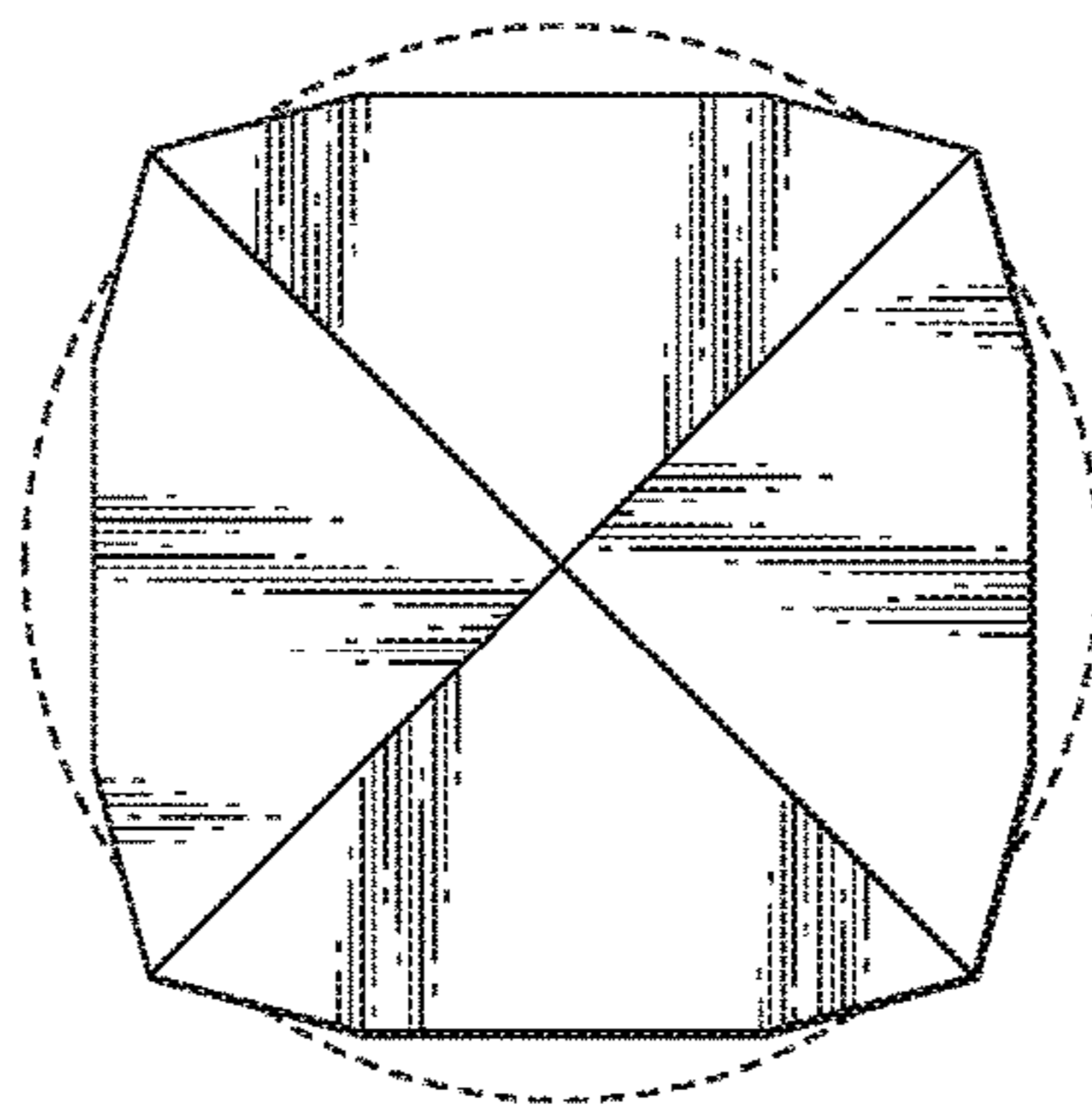

FIG.10

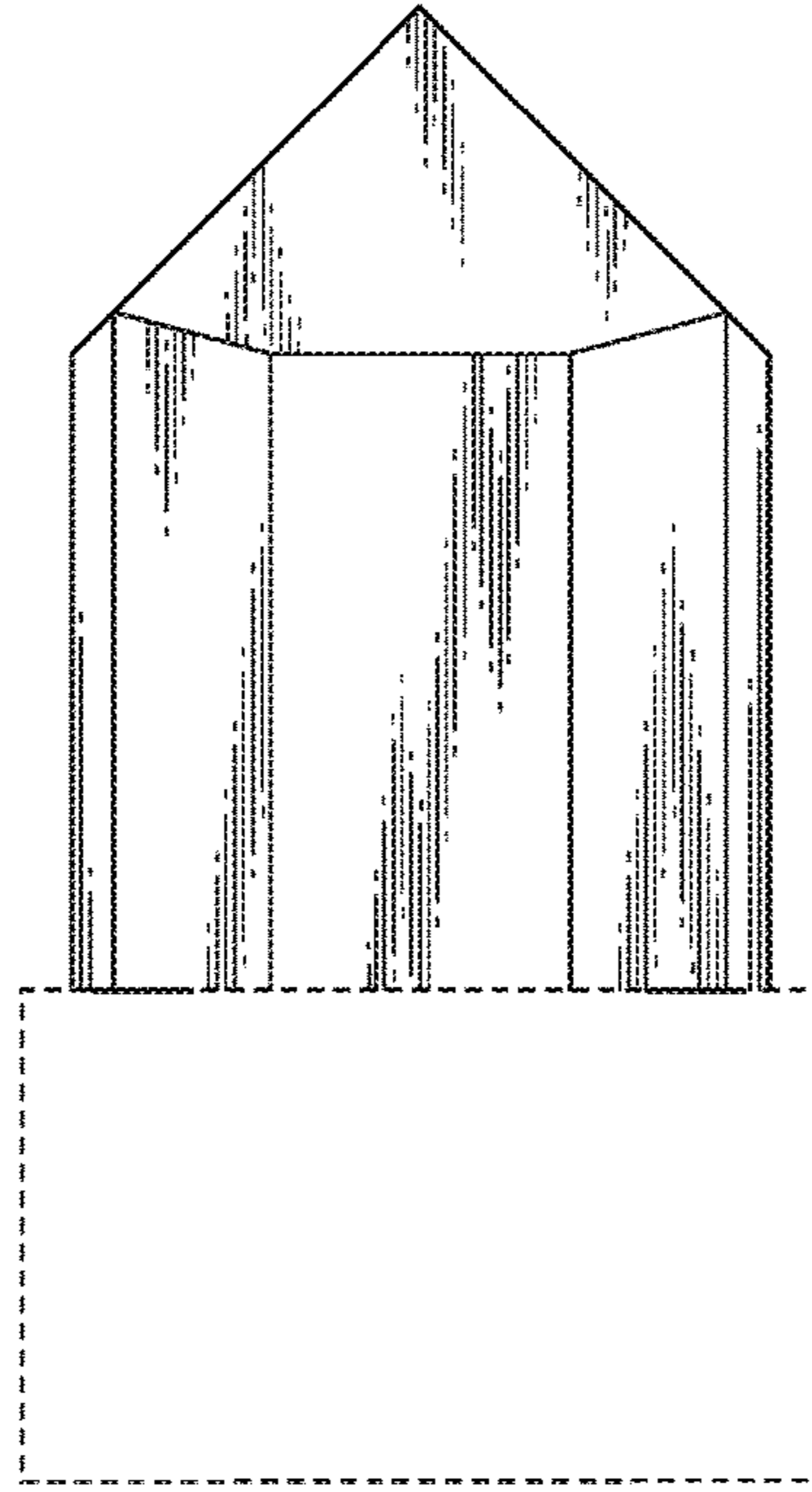

FIG.11

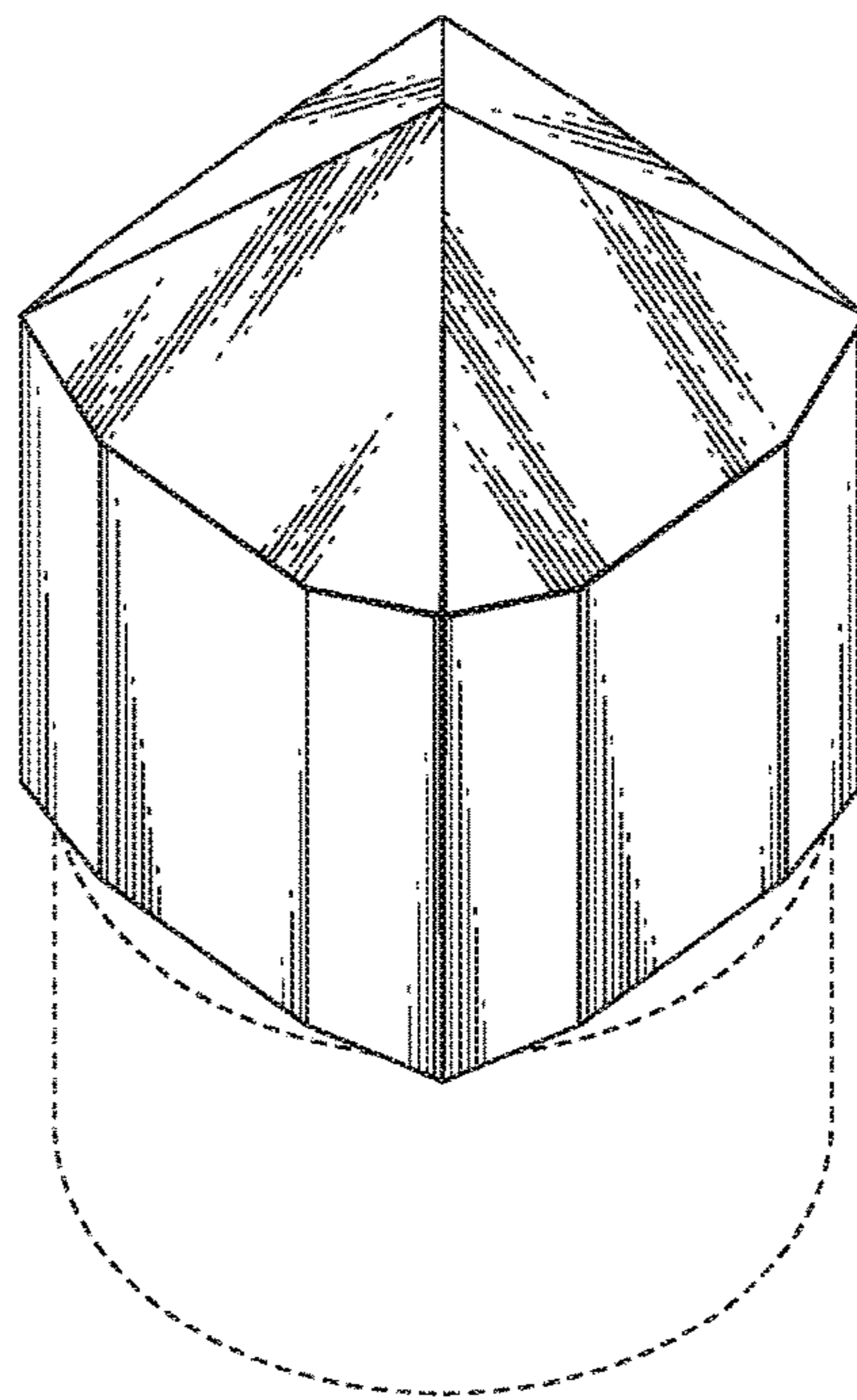

FIG.12

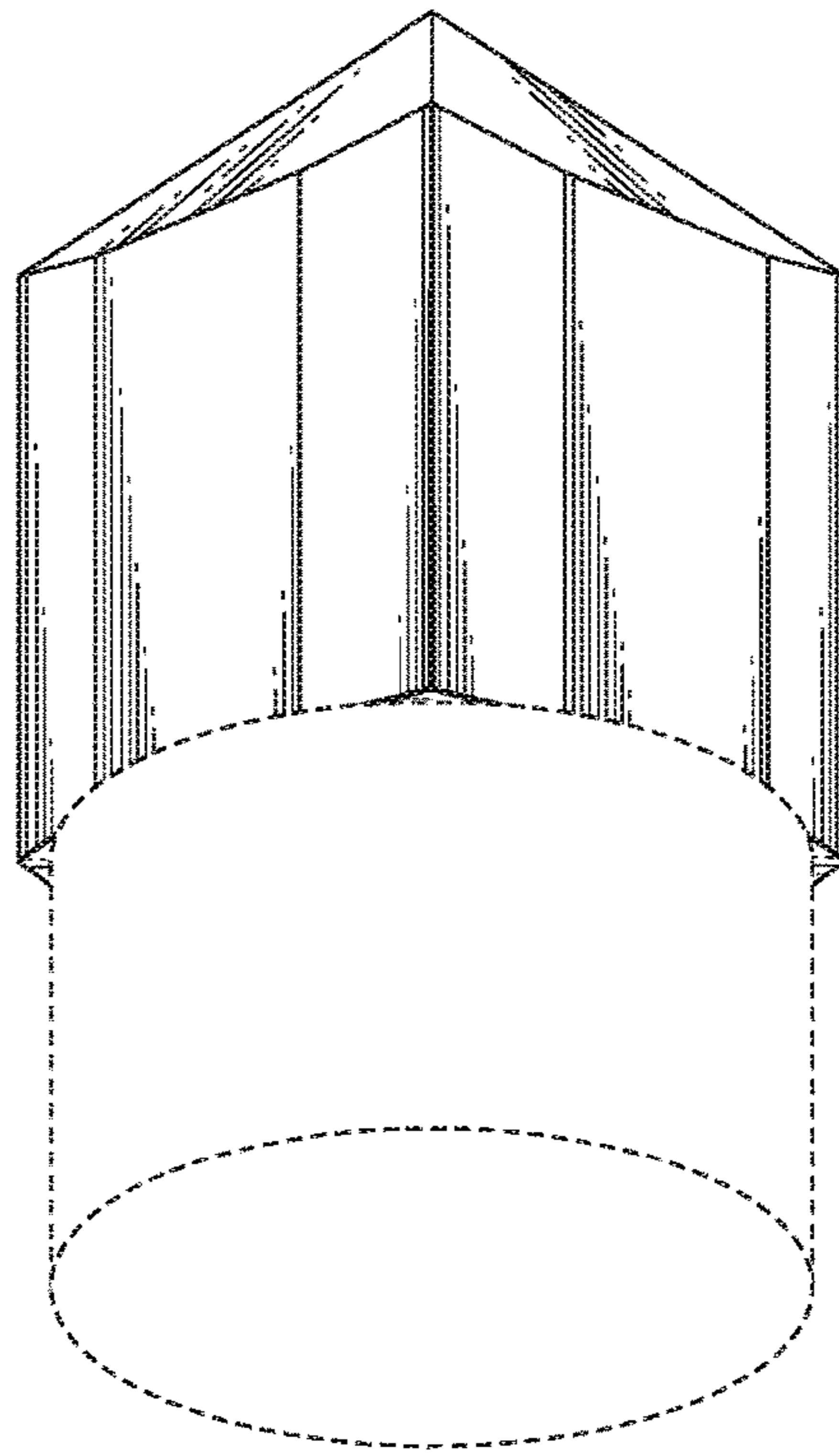

FIG.13

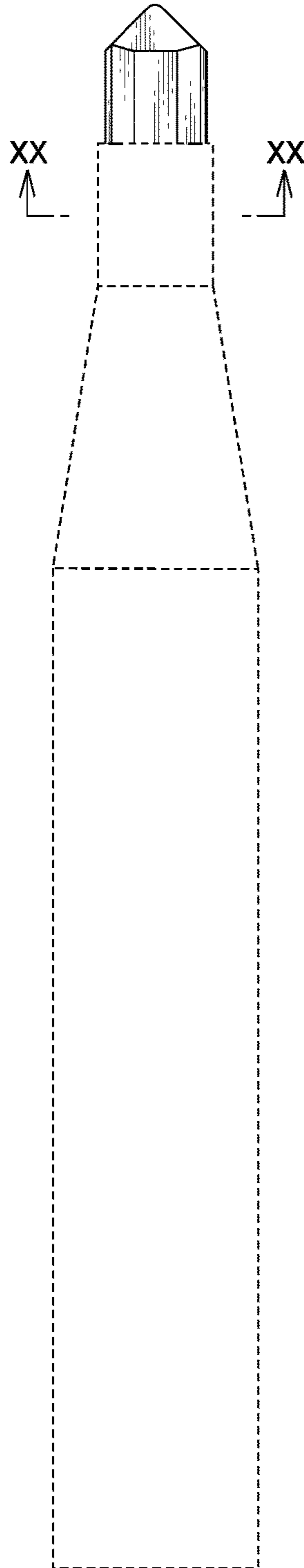

FIG.14

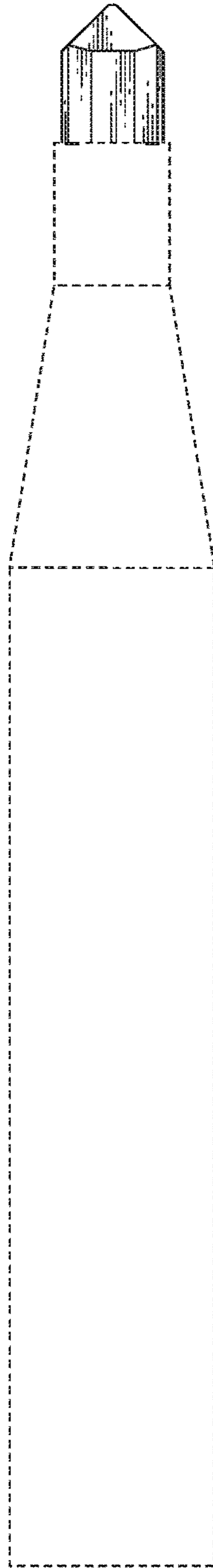

FIG.15

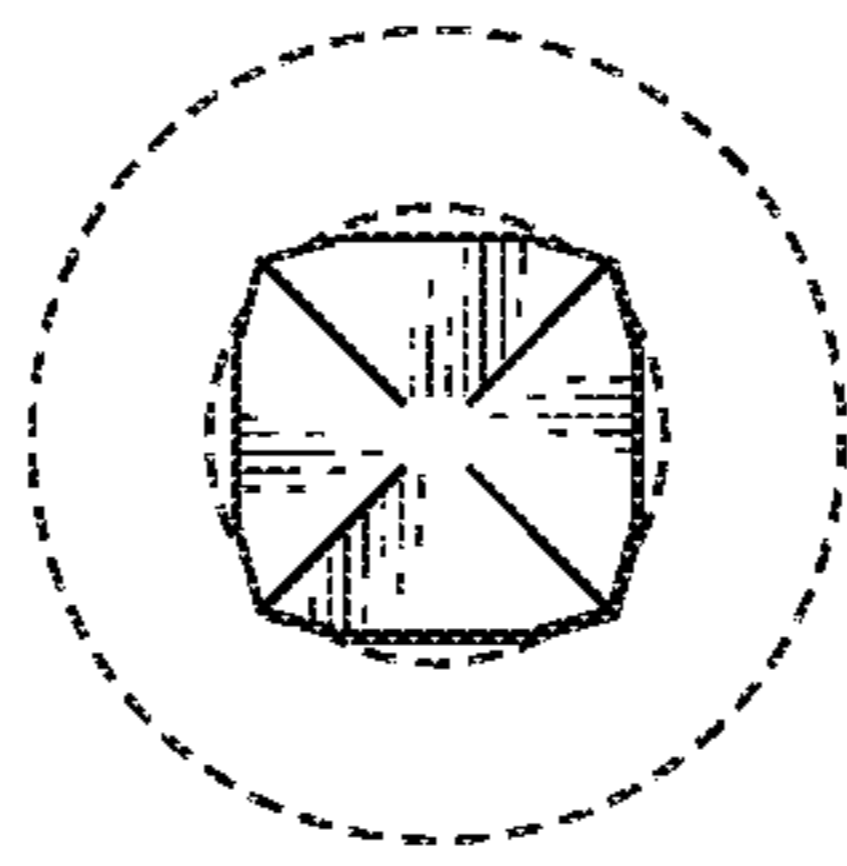

FIG.16

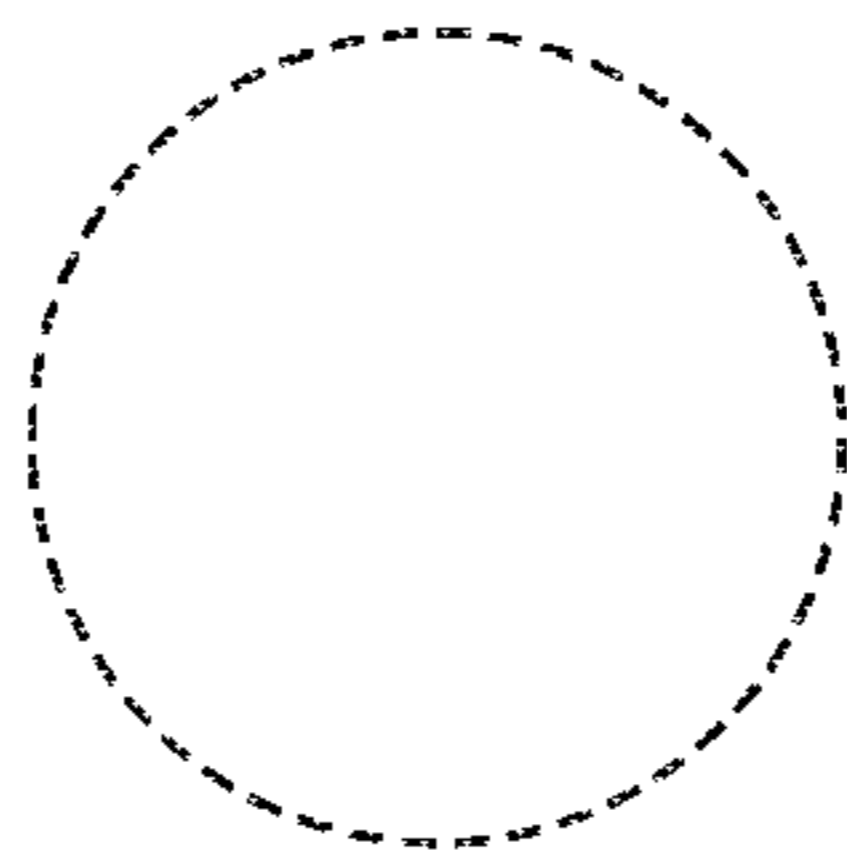

FIG.17

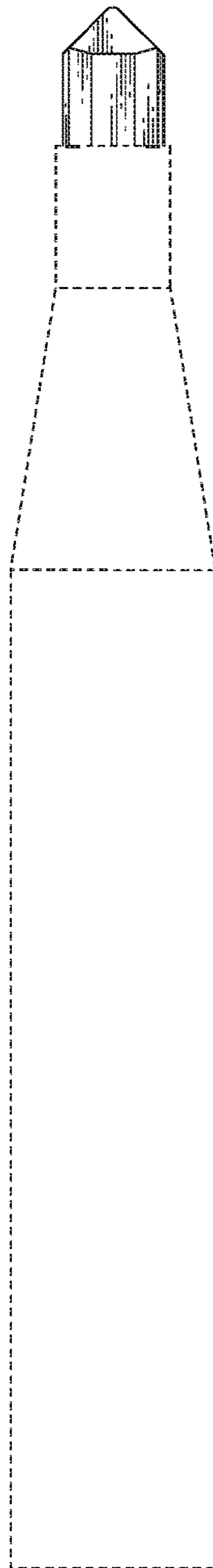

FIG.18

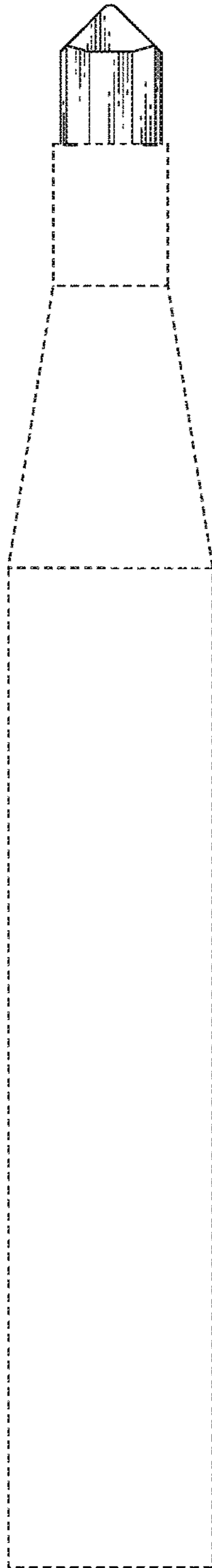



FIG.19

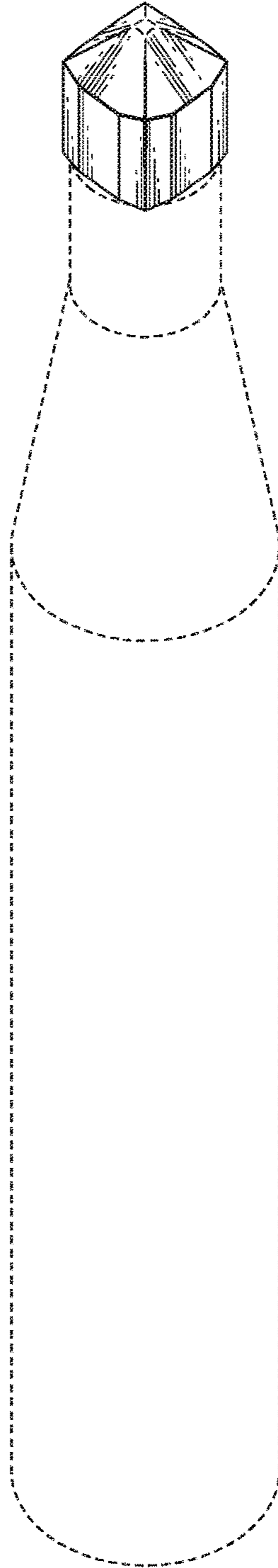

FIG. 20

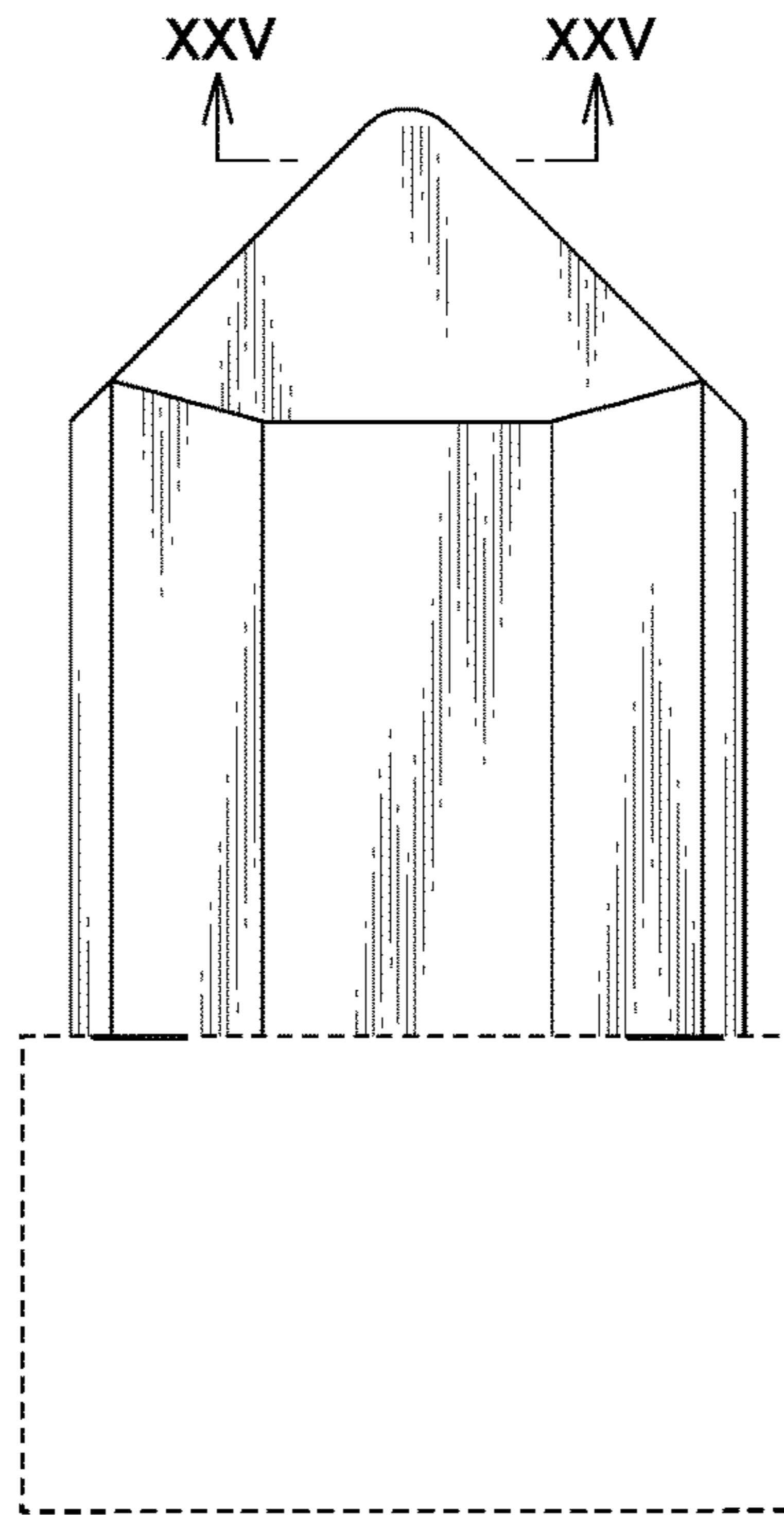

FIG. 21

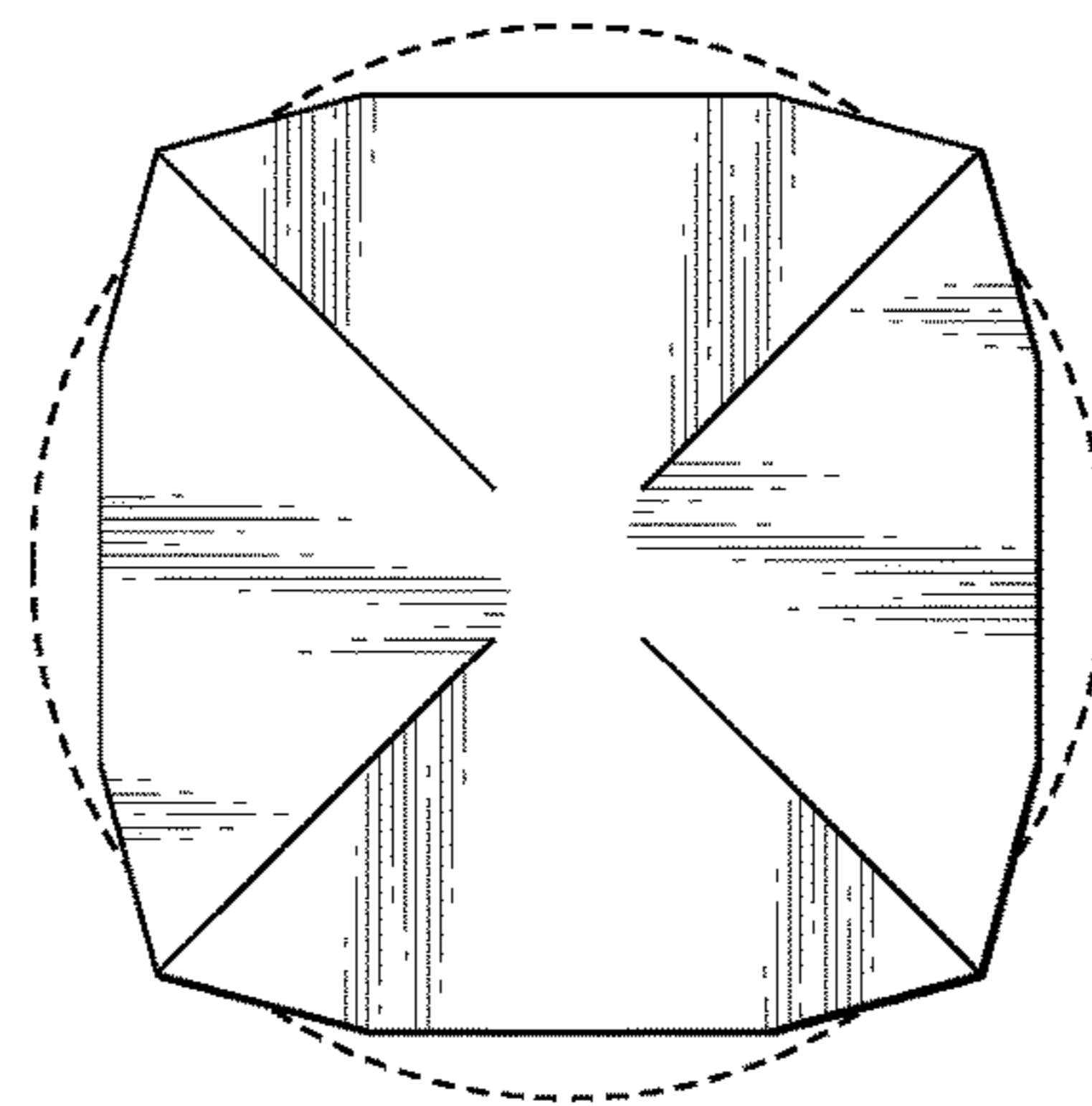

FIG.22

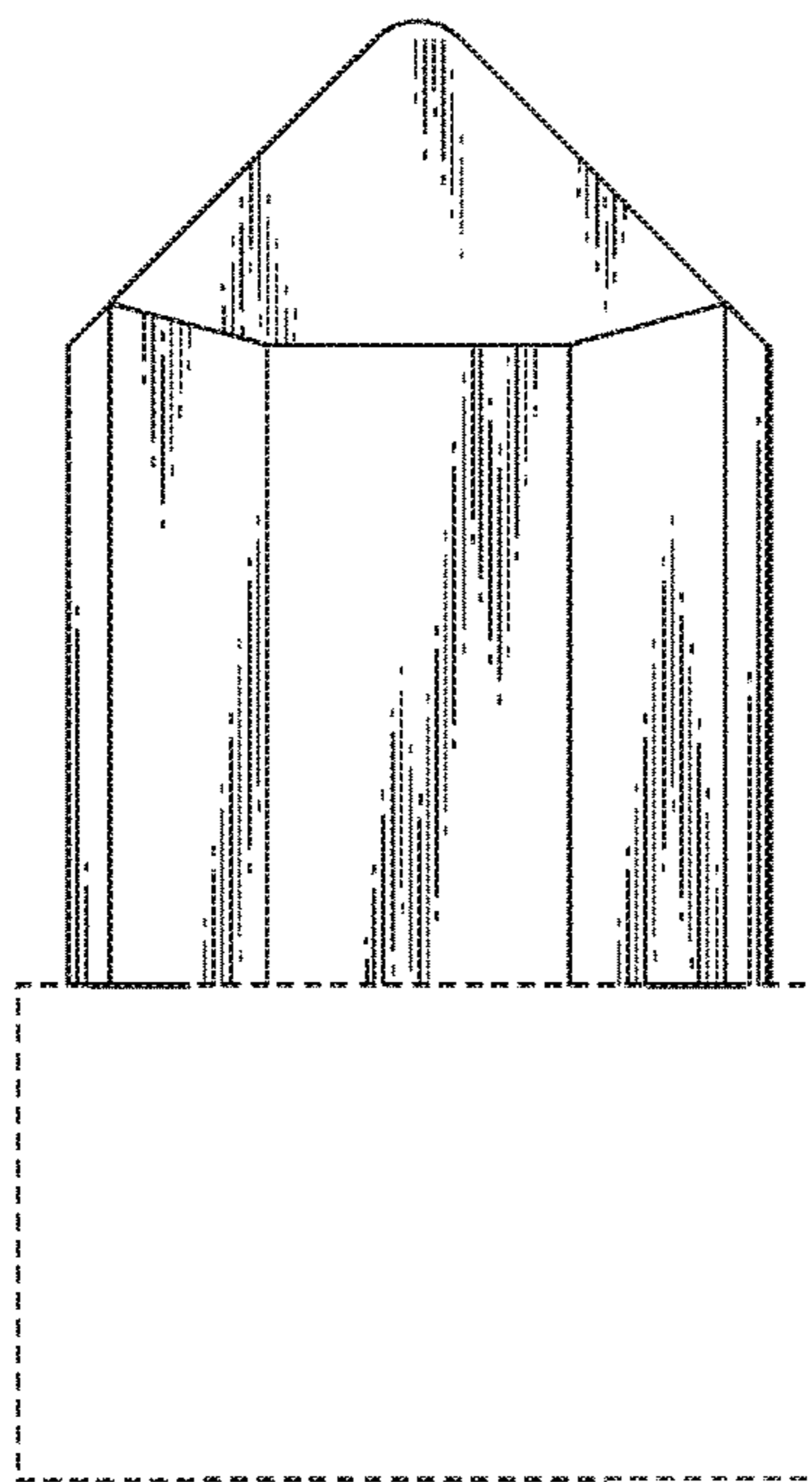

FIG.23

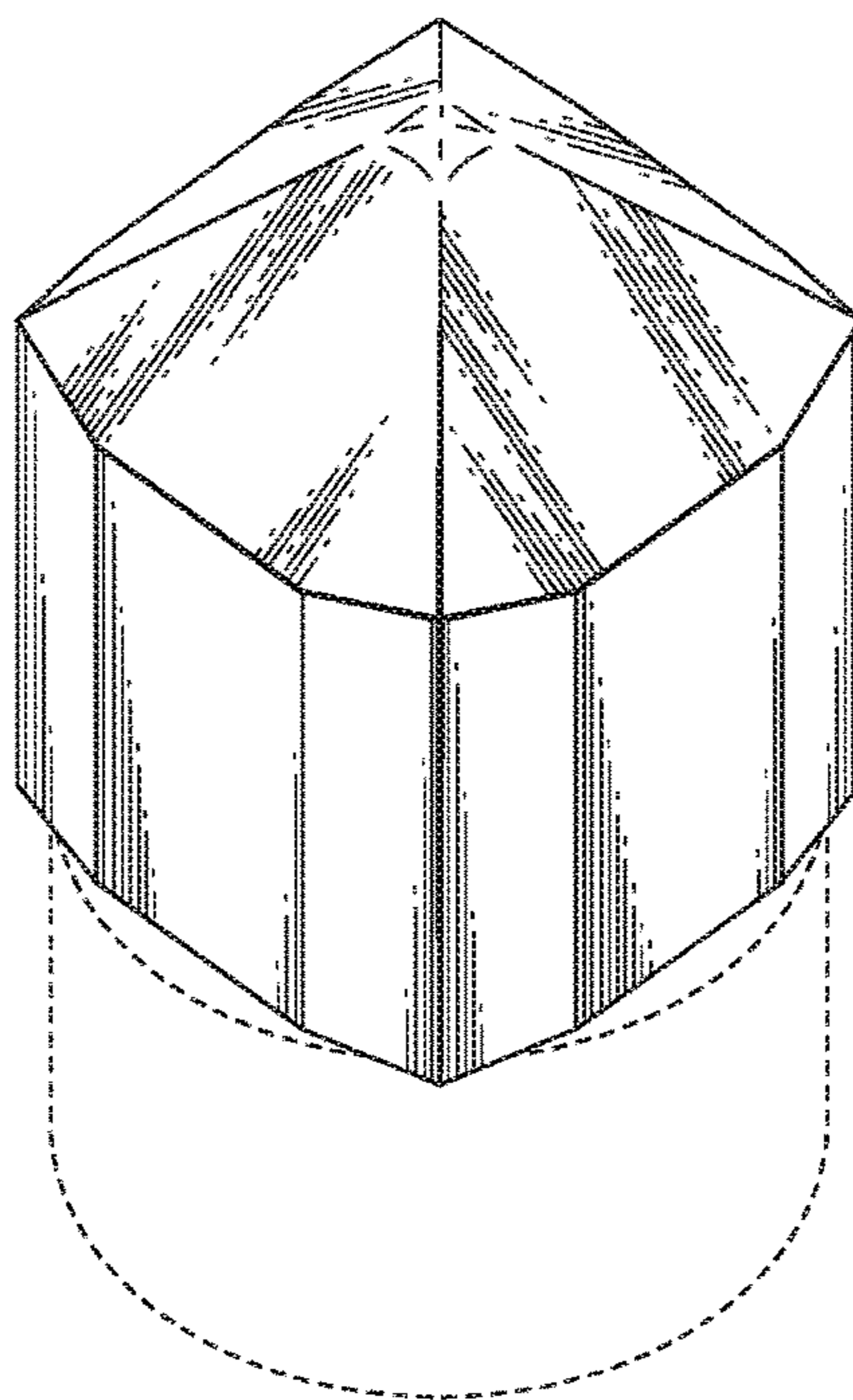

FIG.24

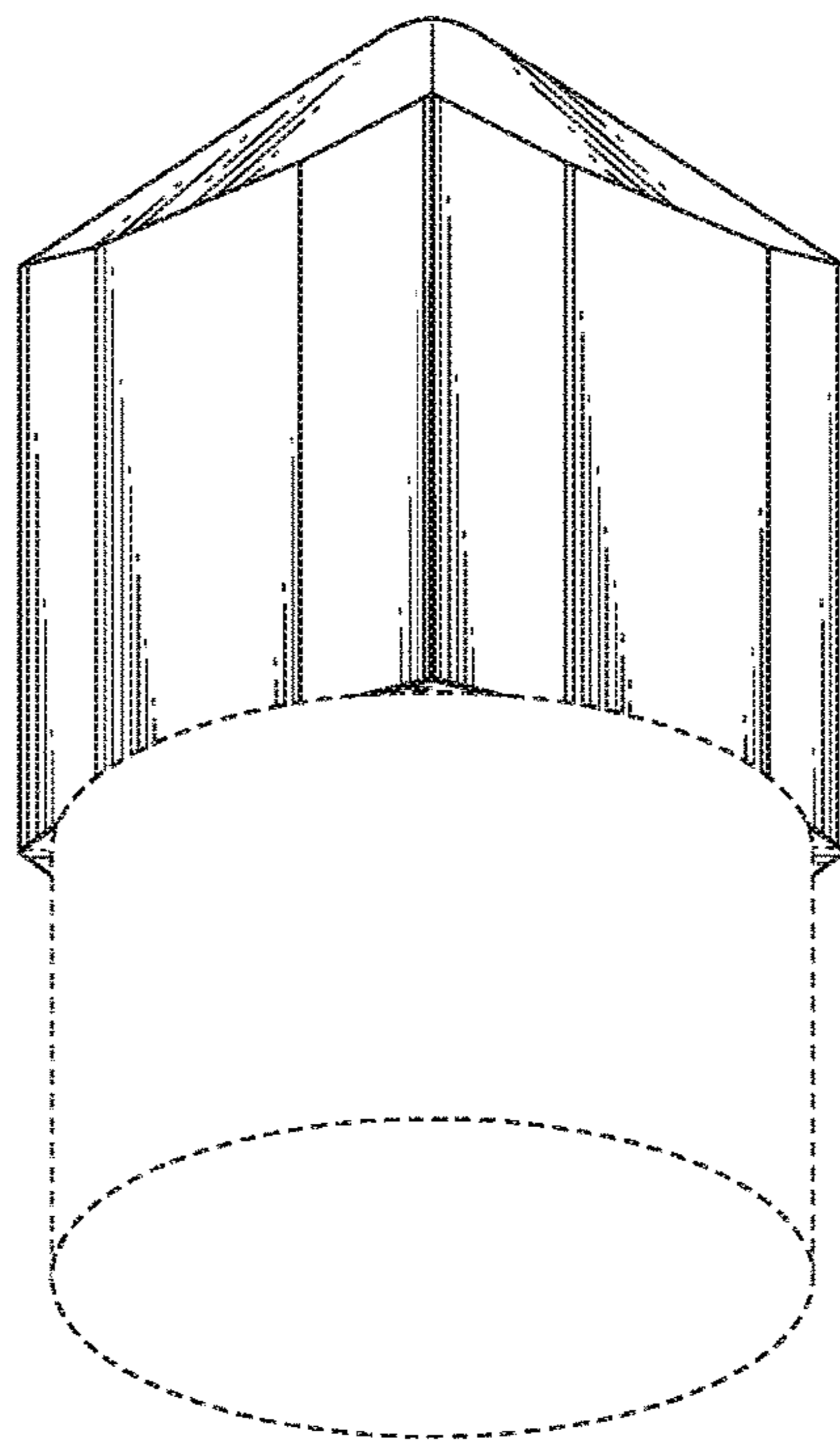

FIG.25

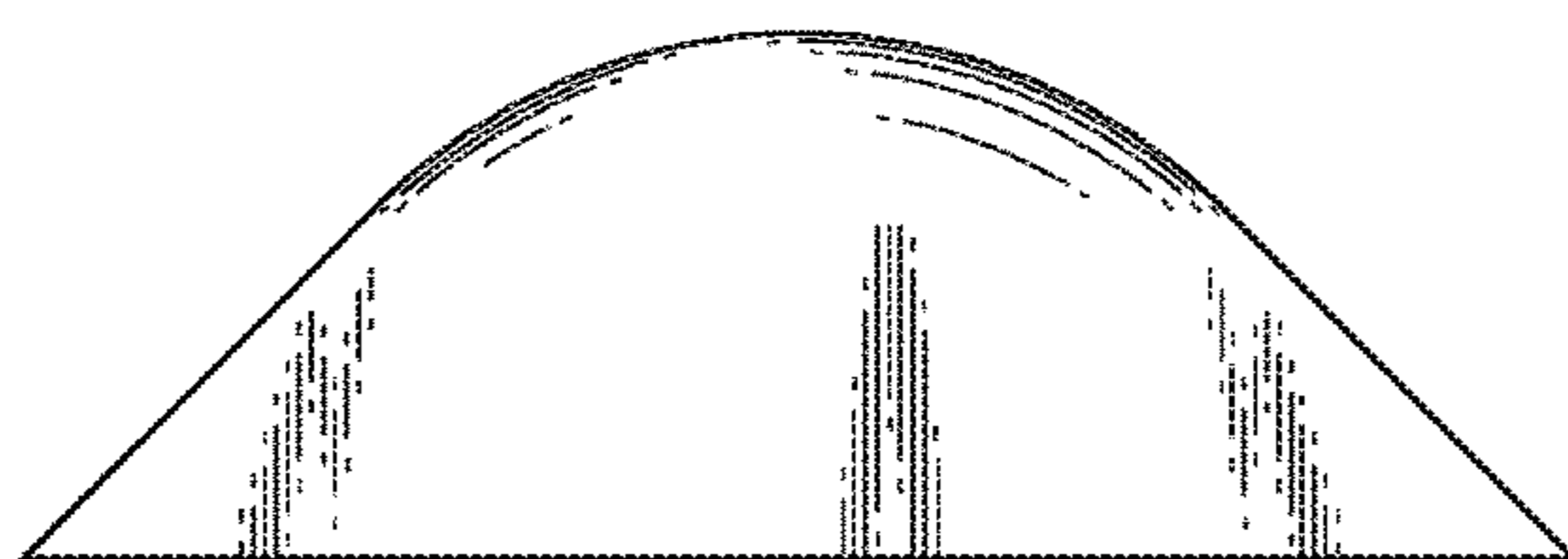

FIG.26

