



US00D847208S

(12) **United States Design Patent** (10) **Patent No.:** **US D847,208 S**
Scott (45) **Date of Patent:** **** Apr. 30, 2019**

(54) **FUEL INJECTOR CLEANER BLOCK**

(71) Applicant: **Motion Pro, Inc.**, Loomis, CA (US)

(72) Inventor: **Steven Richard Scott**, Curlew, WA (US)

(73) Assignee: **Motion Pro, Inc.**, Loomis, CA (US)

(**) Term: **14 Years**

(21) Appl. No.: **29/490,118**

(22) Filed: **May 7, 2014**

(51) **LOC (11) Cl.** **15-01**

(52) **U.S. Cl.**
USPC **D15/5**

(58) **Field of Classification Search**
USPC D15/1-6; 134/113, 169 A; 123/198 A;
D12/400; D13/184
See application file for complete search history.

(56) **References Cited**

U.S. PATENT DOCUMENTS

6,000,413 A * 12/1999 Chen 134/102.2
6,820,627 B1 * 11/2004 Cordova 134/110
2008/0172819 A1 * 7/2008 Brooks 15/302

* cited by examiner

Primary Examiner — T Chase Nelson

Assistant Examiner — Ania Aman

(74) *Attorney, Agent, or Firm* — Larry B. Guernsey; The Patent Law Office of Larry Guernsey

(57) **CLAIM**

The ornamental design for a fuel injector cleaner block, as shown and described above.

DESCRIPTION

FIG. 1 is a top plan view of an ornamental design for a fuel injector cleaner block of the present invention; FIG. 2 is a front view of an ornamental design for a fuel injector cleaner block of the present invention; FIG. 3 is a right side view of an ornamental design for a fuel injector cleaner block of the present invention; FIG. 4 is a rear view of an ornamental design for a fuel injector cleaner block of the present invention; FIG. 5 is a left side view of an ornamental design for a fuel injector cleaner block of the present invention; FIG. 6 is a bottom plan view of an ornamental design for a fuel injector cleaner block of the present invention; FIG. 7 is a top isometric view of an ornamental design for a fuel injector cleaner block of the present invention; and, FIG. 8 is a bottom isometric view of an ornamental design for a fuel injector cleaner block of the present invention. The broken line shown in the drawings are for the purpose of illustrating portions of the article that form no part of the claimed design.

1 Claim, 8 Drawing Sheets

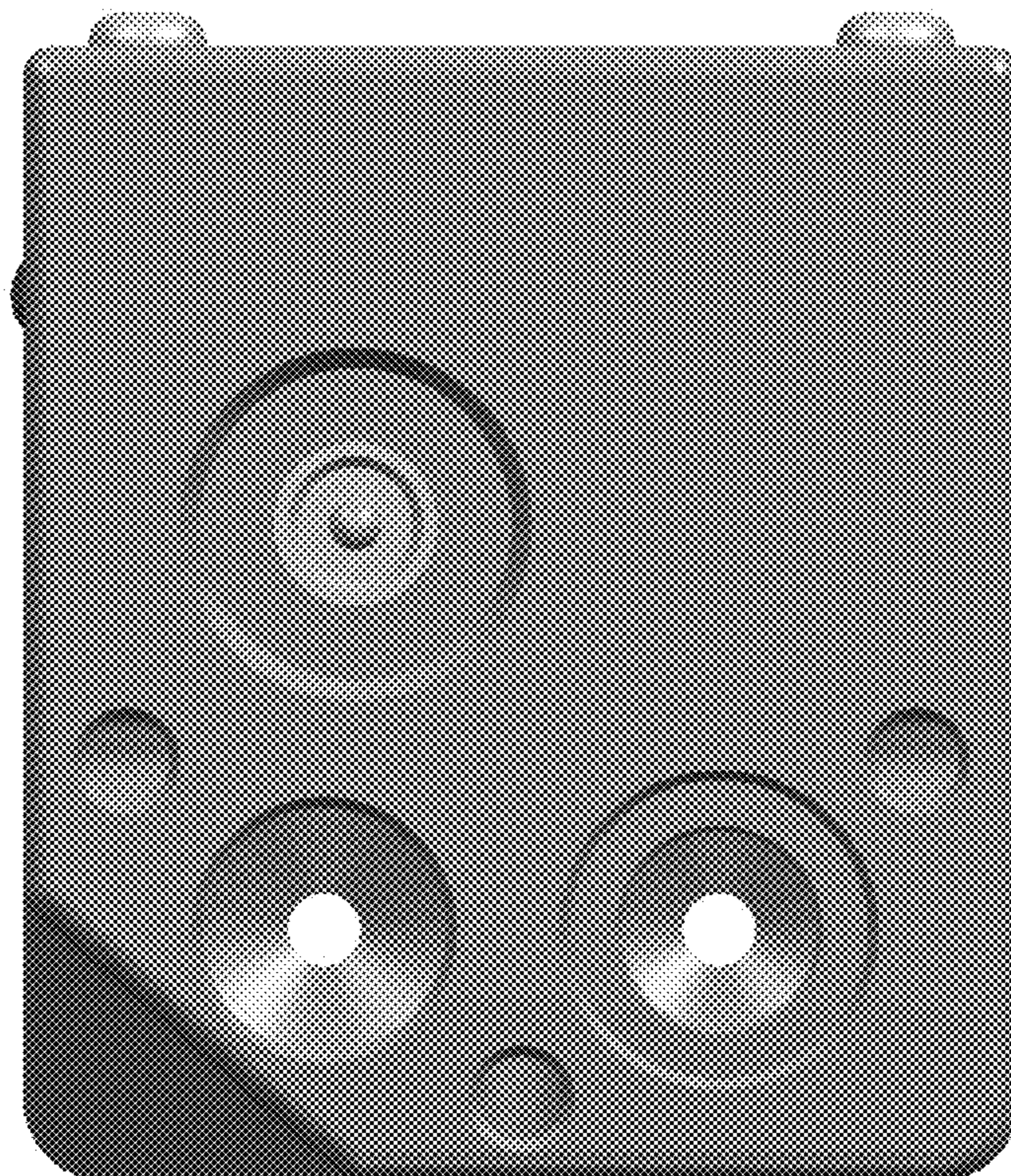

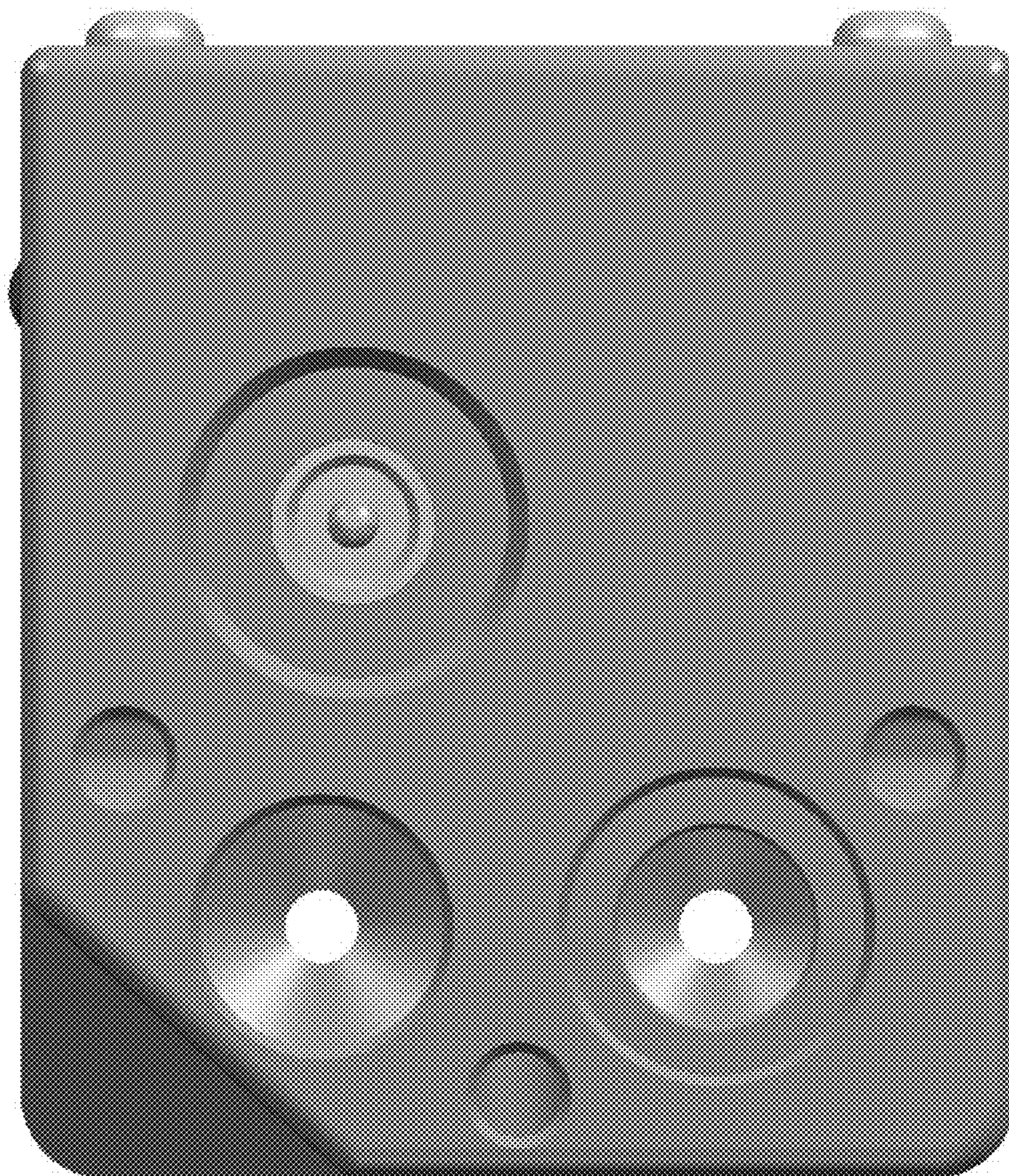

FIGURE 1

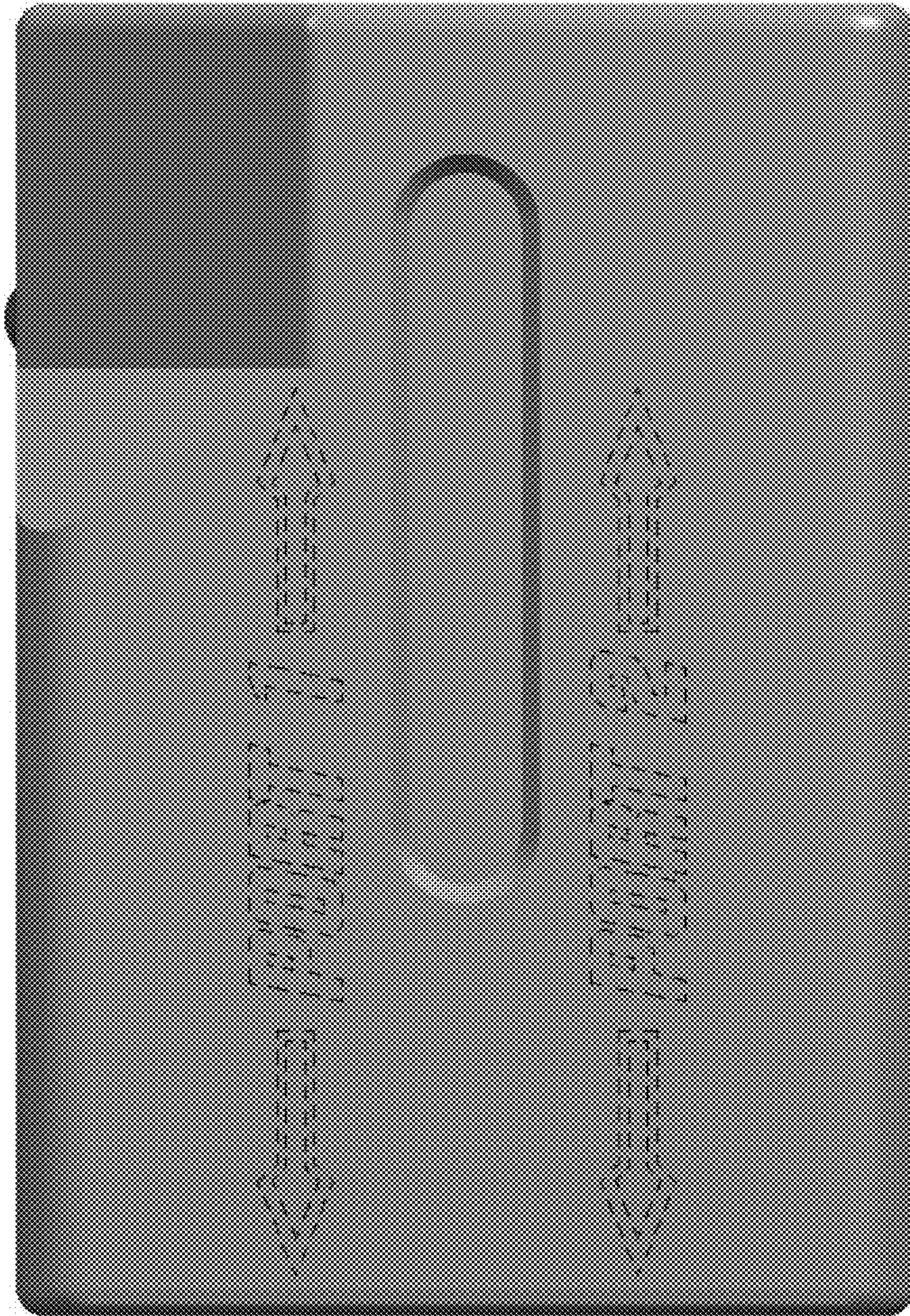

FIGURE 2

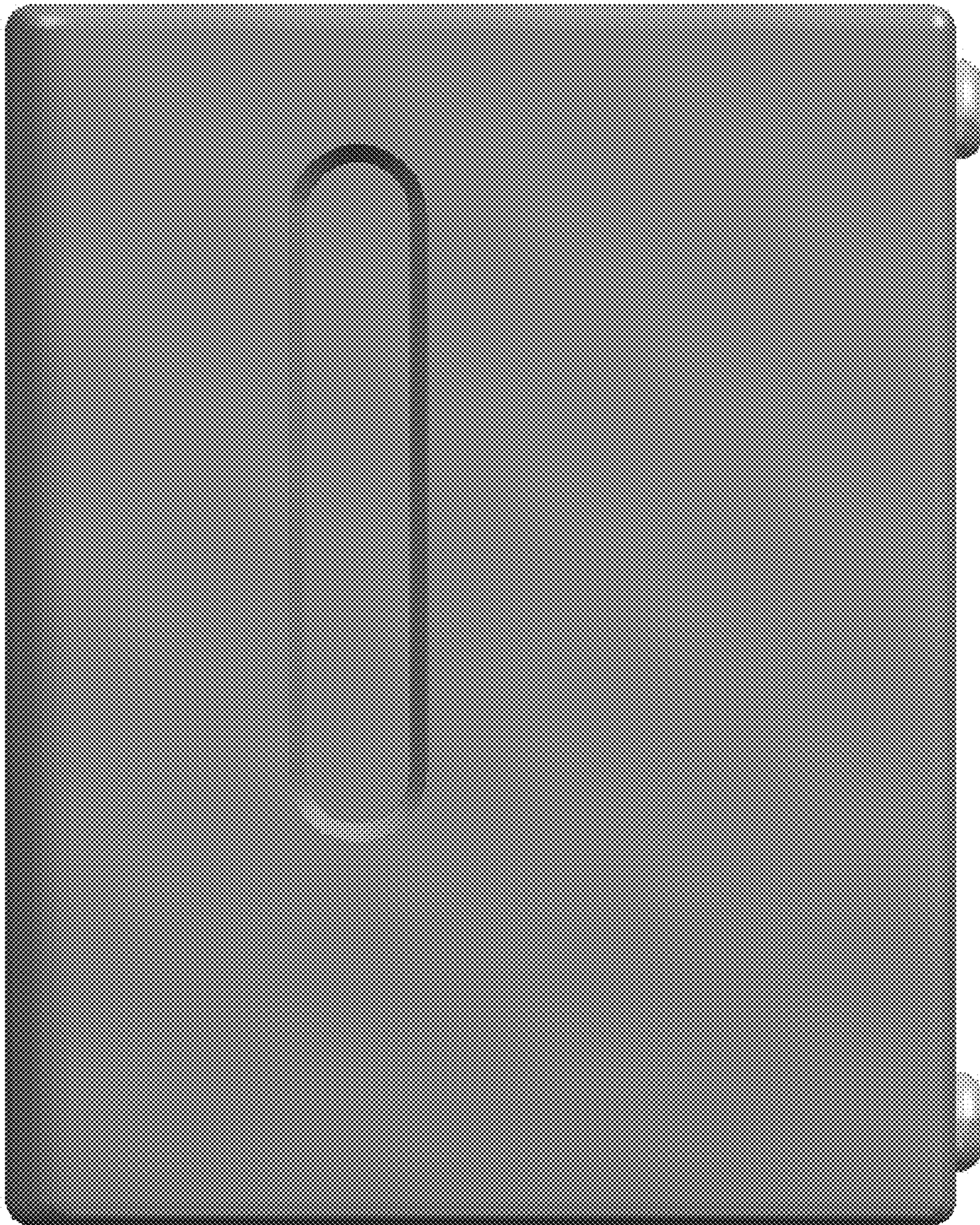

FIGURE 3

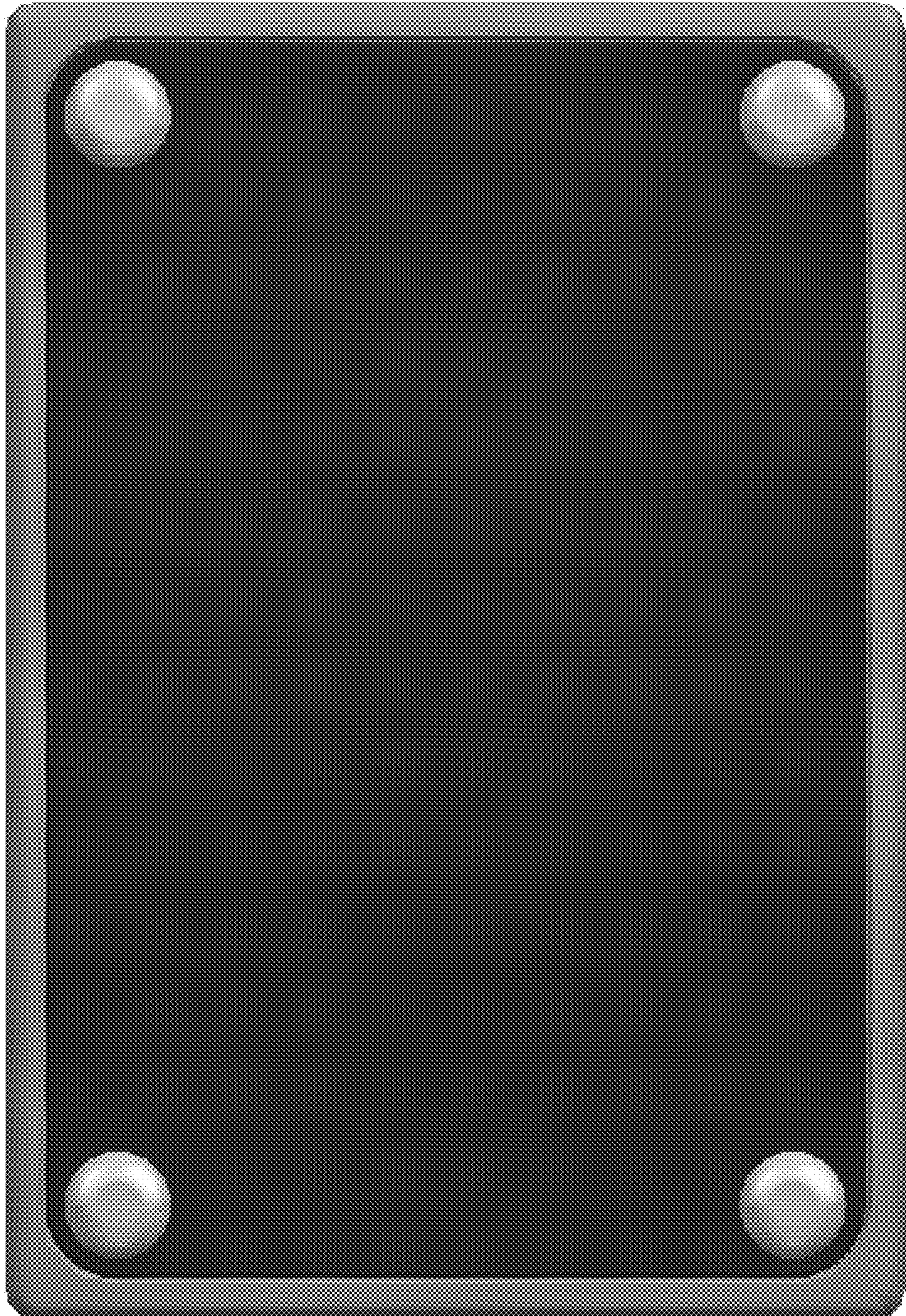

FIGURE 4



FIGURE 5

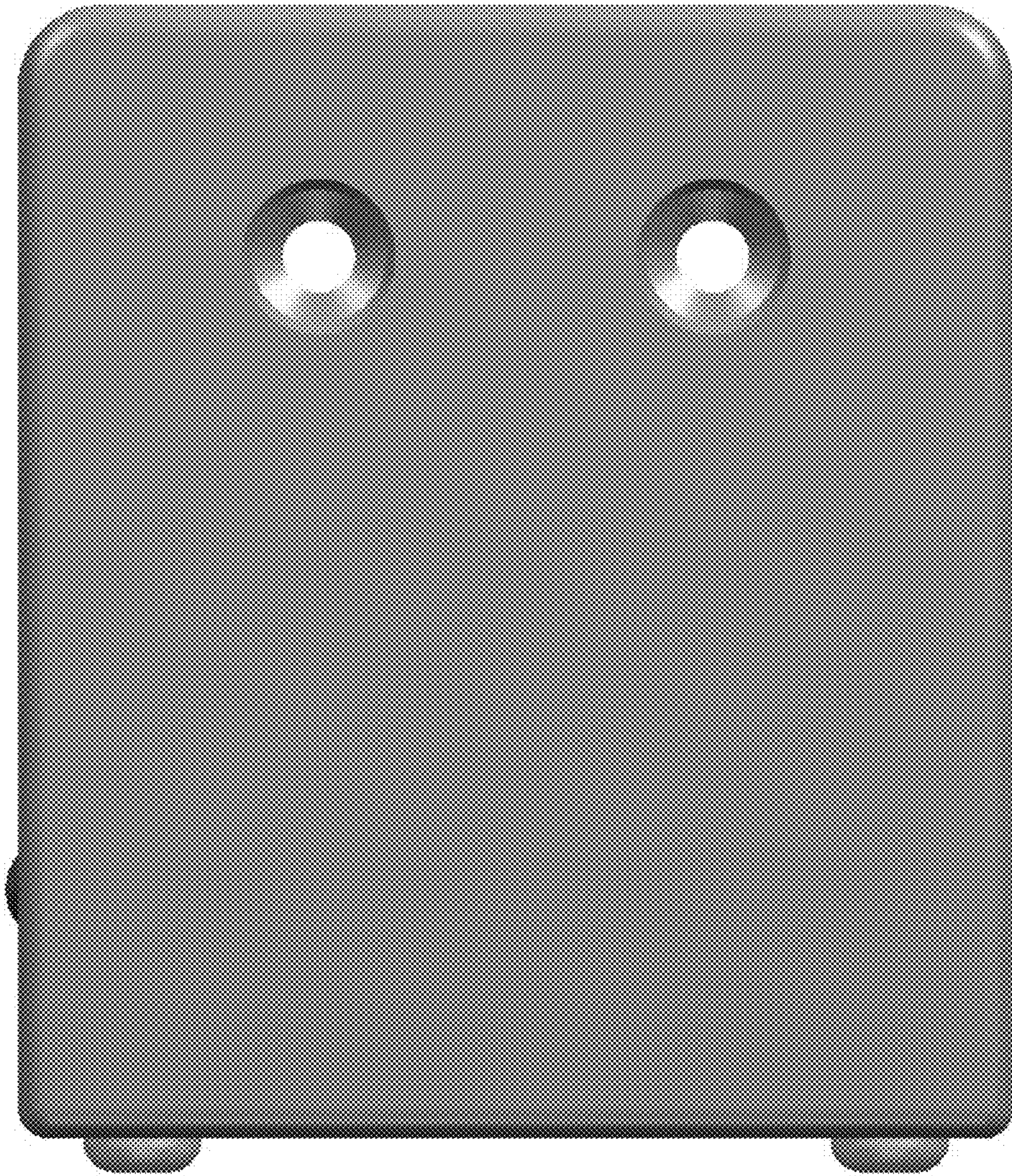

FIGURE 6

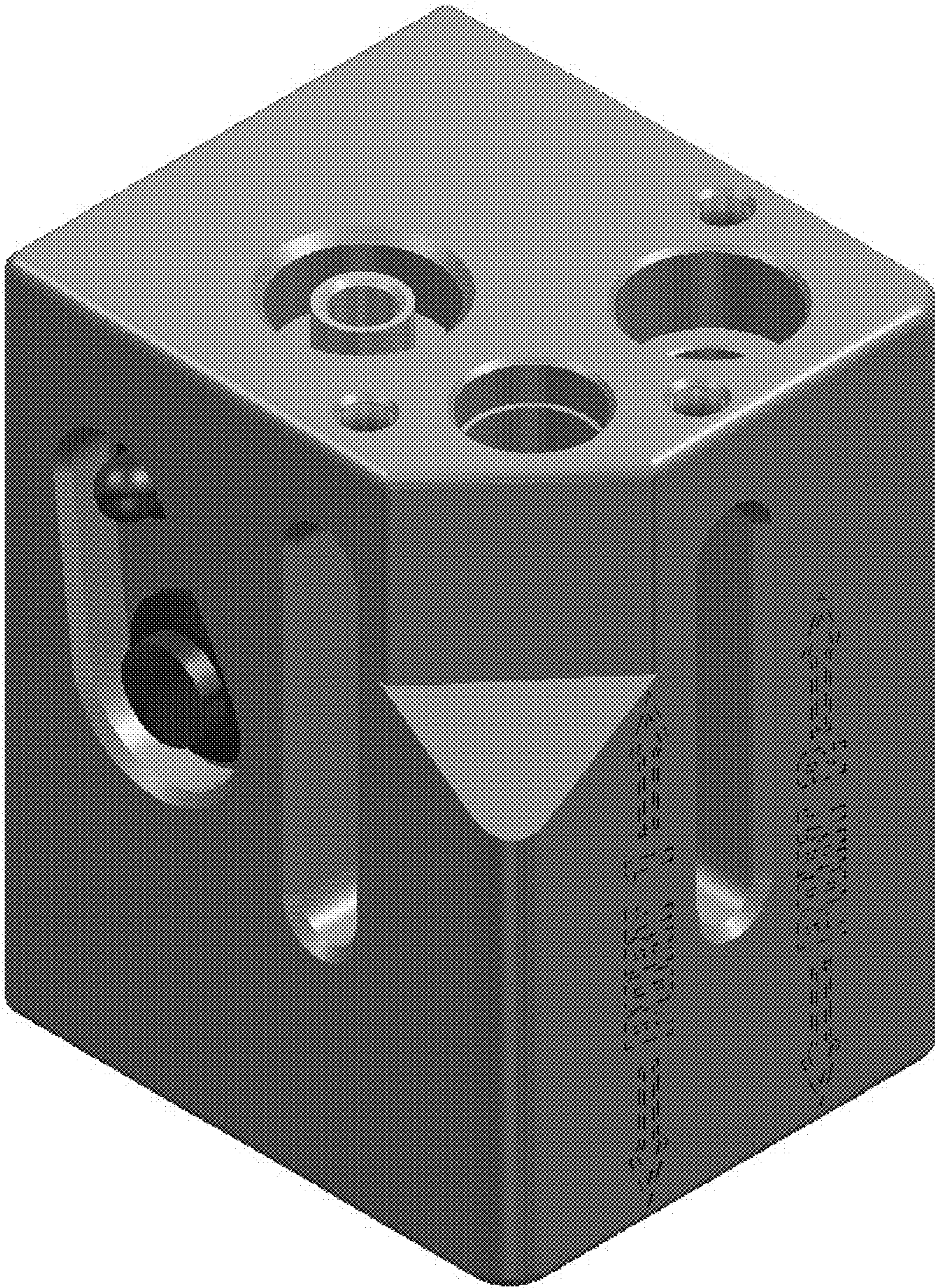

FIGURE 7

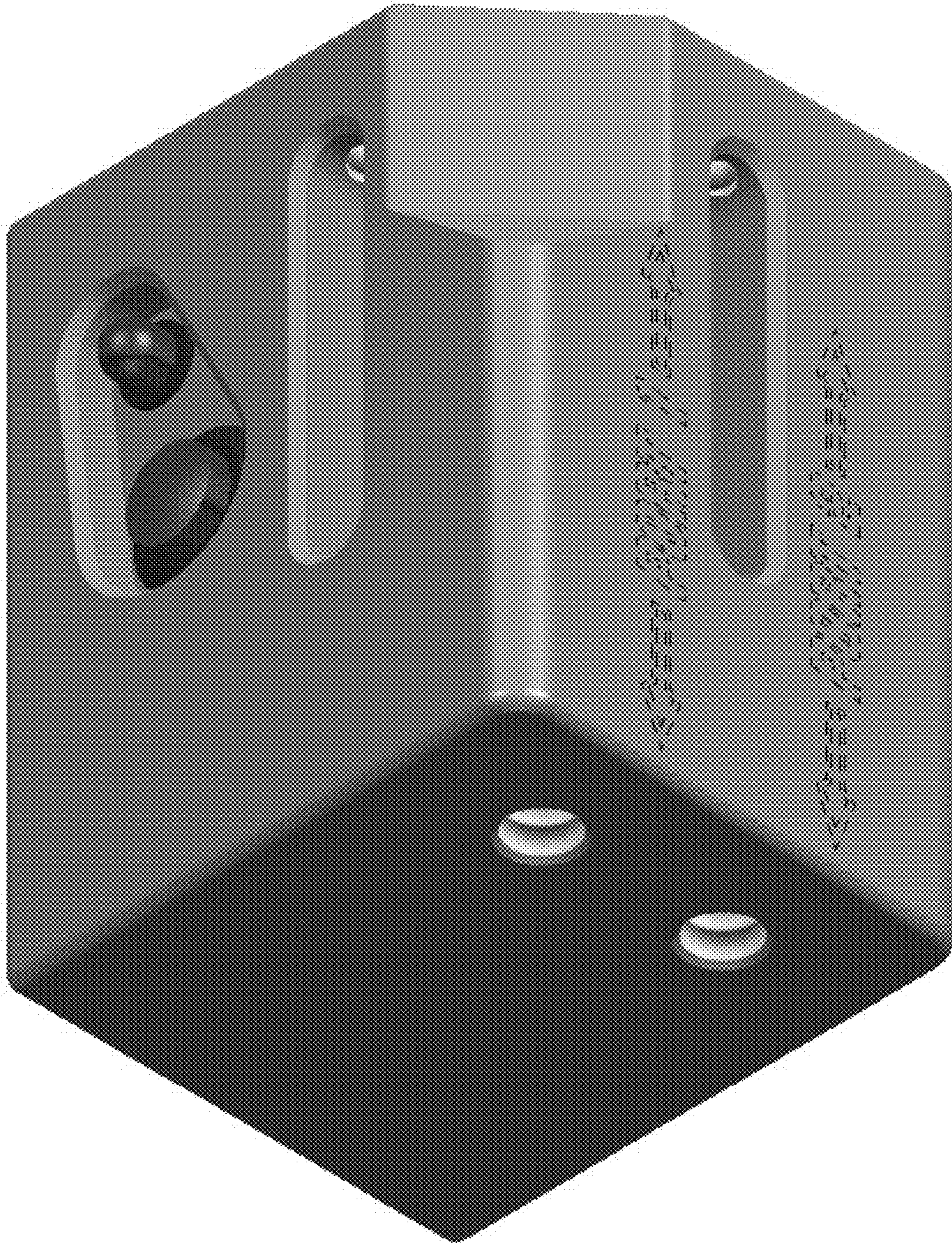

FIGURE 8