



US00D847124S

(12) **United States Design Patent**
Smith et al.

(10) **Patent No.:** **US D847,124 S**
(45) **Date of Patent:** **** Apr. 30, 2019**

- (54) **EARPIECE**
- (71) Applicant: **SureFire, LLC**, Fountain Valley, CA (US)
- (72) Inventors: **Richard C. Smith**, Costa Mesa, CA (US); **Diann Y. Smith**, Costa Mesa, CA (US); **Alfredo Soria**, Corona, CA (US)
- (73) Assignee: **SureFire, LLC**, Fountain Valley, CA (US)
- (**) Term: **15 Years**

2,391,924 A 1/1946 Rutter et al.
 2,549,629 A 4/1951 Nelson
 D174,053 S * 2/1955 Norris 455/351
 (Continued)

Primary Examiner — Paula Allen Greene
 (74) *Attorney, Agent, or Firm* — Haynes and Boone, LLP

- (21) Appl. No.: **29/594,279**
- (22) Filed: **Feb. 16, 2017**

Related U.S. Application Data

- (63) Continuation of application No. 29/541,896, filed on Oct. 8, 2015, now Pat. No. Des. 779,461.
- (51) **LOC (11) Cl.** **14-01**
- (52) **U.S. Cl.**
USPC **D14/223**
- (58) **Field of Classification Search**
USPC D14/205, 223, 240, 249; D24/174;
181/129, 130, 135; 379/430, 431;
381/380, 381, 374, 375, 379; 455/90.3,
455/575.1, 569.1; 128/864, 865, 866
CPC H04R 1/105; H04R 1/008; H04R 1/1066;
H04R 25/00; H04R 25/02; H04R 1/10;
H04R 1/1016; H04R 25/652
See application file for complete search history.

(57) **CLAIM**

The ornamental design for an earpiece, as shown and described.

DESCRIPTION

FIG. 1 is a front right perspective view of an earpiece showing our new design;
 FIG. 2 is a rear left perspective view thereof;
 FIG. 3 is a left side elevational view thereof;
 FIG. 4 is a right side elevational view thereof;
 FIG. 5 is a front side elevational view thereof;
 FIG. 6 is a rear side elevational view thereof;
 FIG. 7 is a top plan view thereof;
 FIG. 8 is a bottom plan view thereof;
 FIG. 9 is a cross-sectional view thereof taken at line 9-9 of FIG. 3; and
 FIG. 10 is a cross-sectional view thereof taken at line 10-10 of FIG. 4.
 FIG. 11 is a front right perspective view of an example audio device for an earpiece shown in broken lines;
 FIG. 12 is a front left perspective view thereof;
 FIG. 13 is a rear right perspective view thereof; and
 FIG. 14 is a rear left perspective view thereof.
 FIG. 15 is a front right perspective view of the earpiece with the example audio device attached thereto, drawn in broken lines;
 FIG. 16 is a front left perspective view thereof;
 FIG. 17 is a rear right perspective view thereof; and
 FIG. 18 is a rear left perspective view thereof.
 The broken lines in the drawings illustrate environmental features and form no part of the claimed design.

(56) **References Cited**
 U.S. PATENT DOCUMENTS

1,614,987 A	1/1927	Langenbeck et al.
1,893,474 A	1/1933	Lieber
2,325,590 A	8/1943	Carlisle et al.
D141,071 S	5/1945	Hechler
2,377,739 A	6/1945	Wyckoff

1 Claim, 18 Drawing Sheets

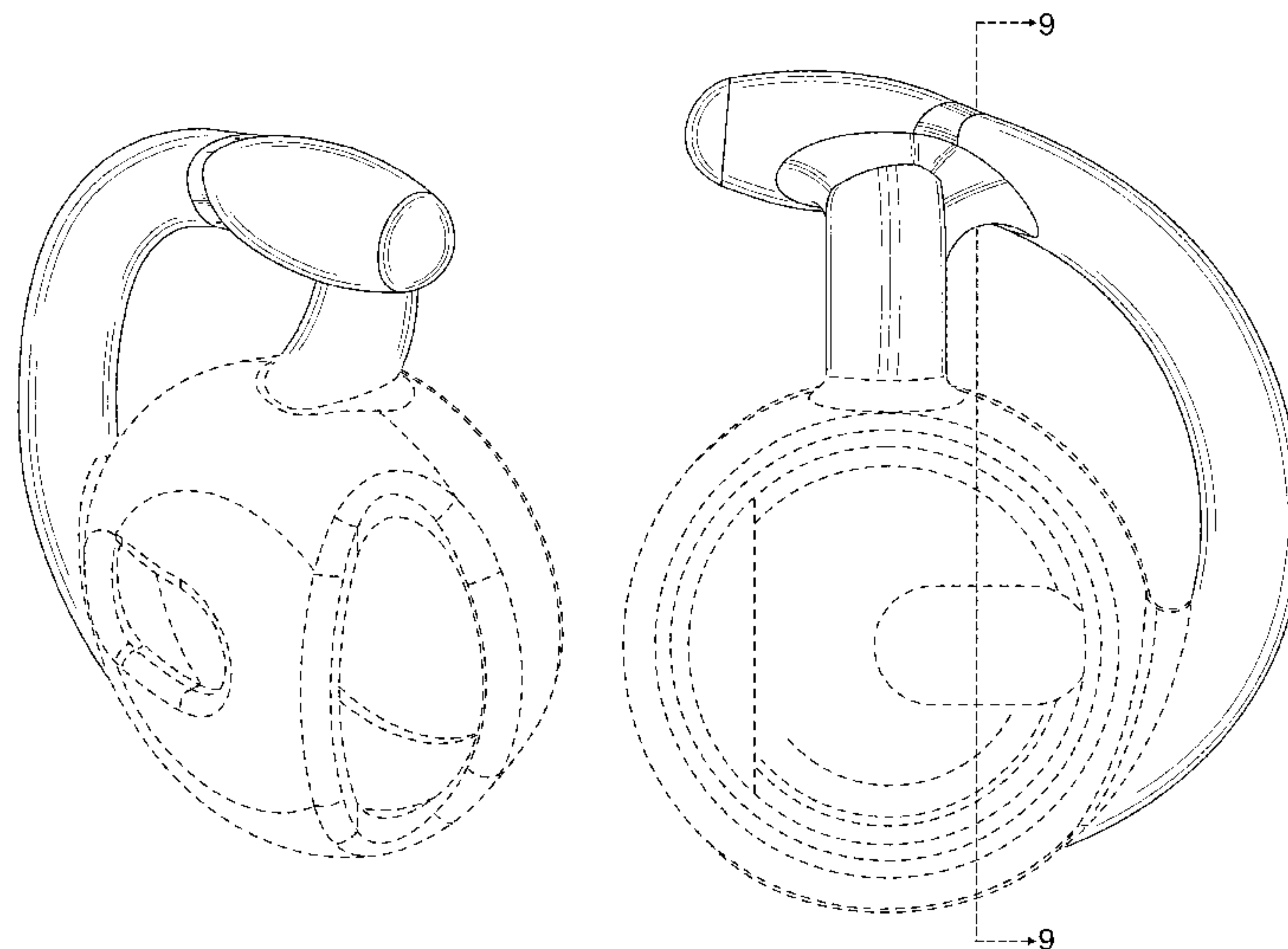

(56)

References Cited

U.S. PATENT DOCUMENTS

2,787,670 A 4/1957 Rownland
 2,804,932 A 9/1957 Bedard
 2,959,645 A 11/1960 Ladd
 3,368,644 A 2/1968 Henderson
 3,993,879 A * 11/1976 Larkin H04B 1/385
 181/20
 4,069,400 A 1/1978 Johanson et al.
 4,311,206 A 1/1982 Johnson
 4,349,083 A 9/1982 Bennett
 D266,590 S 10/1982 Bennett
 4,453,050 A * 6/1984 Enokido H04R 1/1066
 381/330
 D309,305 S * 7/1990 von Hall D14/225
 D321,881 S * 11/1991 Hopewell D14/192
 D326,653 S * 6/1992 Hino D14/192
 5,146,051 A 9/1992 Hermann
 5,210,792 A * 5/1993 Kajihara H04M 1/05
 379/430
 5,345,509 A 9/1994 Hofer et al.
 D357,479 S * 4/1995 Coomans D14/223
 5,412,736 A * 5/1995 Keliiliki H04R 1/105
 381/330
 D366,486 S * 1/1996 Runquist D14/142
 5,659,156 A 8/1997 Mauney et al.
 D388,093 S 12/1997 Frengley
 5,708,724 A * 1/1998 Burris H04M 1/05
 381/370
 D419,564 S * 1/2000 McDonald D14/223
 D421,755 S * 3/2000 Pitel D14/223
 6,101,260 A * 8/2000 Jensen H04M 1/05
 379/430
 D441,739 S * 5/2001 Hayes D14/223
 D443,261 S * 6/2001 Yuyama D14/223
 D449,295 S 10/2001 Smith et al.
 D460,749 S * 7/2002 Liu D14/206
 6,418,230 B1 * 7/2002 McDonald H04R 1/10
 379/426
 D462,943 S * 9/2002 Lucaci D14/206
 D463,791 S * 10/2002 Nagai D14/205
 D464,638 S * 10/2002 Huang D14/205
 D468,728 S * 1/2003 Rath D14/206
 D478,573 S * 8/2003 Wrisley D14/223
 D478,991 S 8/2003 Dyer et al.
 6,690,807 B1 2/2004 Meyer
 6,772,853 B2 * 8/2004 Yang H04R 1/1066
 181/129
 6,879,697 B2 4/2005 Tøpholm
 D510,085 S * 9/2005 Suzuki D14/223
 D523,845 S * 6/2006 Smith D14/205

7,110,535 B2 * 9/2006 Bodley H04M 1/05
 379/430
 D532,110 S 11/2006 Bailey et al.
 7,139,404 B2 11/2006 Feeley et al.
 D538,268 S * 3/2007 Gibson D14/223
 D538,270 S * 3/2007 Kim D14/223
 D563,945 S 3/2008 Johns et al.
 D566,104 S * 4/2008 Suzuki D14/223
 D585,429 S * 1/2009 Dean D14/223
 D590,813 S * 4/2009 Bradford D14/205
 7,539,525 B2 * 5/2009 Kim H04M 1/05
 379/433.13
 D601,134 S 9/2009 Elabidi et al.
 D618,219 S 6/2010 Burgett et al.
 D622,265 S 8/2010 Rye
 D622,704 S 8/2010 Fahrendorff et al.
 7,778,435 B2 8/2010 Smith et al.
 D628,990 S * 12/2010 Pedersen D14/223
 D630,621 S 1/2011 Pedersen
 D640,670 S 6/2011 Rye
 D641,008 S 7/2011 Lee et al.
 D655,693 S 3/2012 Silvestri et al.
 D664,124 S * 7/2012 Smith D14/223
 8,311,253 B2 11/2012 Silvestri et al.
 D687,021 S 7/2013 Yuen
 D694,220 S 11/2013 Lee et al.
 8,611,969 B2 12/2013 Smith et al.
 8,625,834 B2 1/2014 Smith et al.
 8,666,085 B2 3/2014 Donaldson et al.
 D714,260 S 9/2014 Han
 D716,770 S 11/2014 Bonahoom et al.
 8,879,769 B2 11/2014 Smith et al.
 8,897,480 B2 11/2014 Tan et al.
 D720,730 S 1/2015 Smith et al.
 D721,354 S 1/2015 Thompson et al.
 8,965,030 B2 2/2015 Aase
 D727,301 S 4/2015 Smith et al.
 D732,008 S 6/2015 Akana et al.
 D735,180 S 7/2015 Smith et al.
 D742,362 S 11/2015 Bonahoom et al.
 D744,456 S 12/2015 Pedersen
 D753,098 S 4/2016 Smith et al.
 D755,158 S 5/2016 Lee et al.
 D759,633 S 6/2016 Gondo
 D777,149 S * 1/2017 Bonahoom D14/223
 D779,461 S * 2/2017 Smith D14/223
 2005/0147269 A1 7/2005 Oliveira et al.
 2008/0152183 A1 * 6/2008 Janik H04M 1/05
 381/375
 2014/0119589 A1 5/2014 Wyzisk et al.
 2016/0073186 A1 3/2016 Searl et al.

* cited by examiner

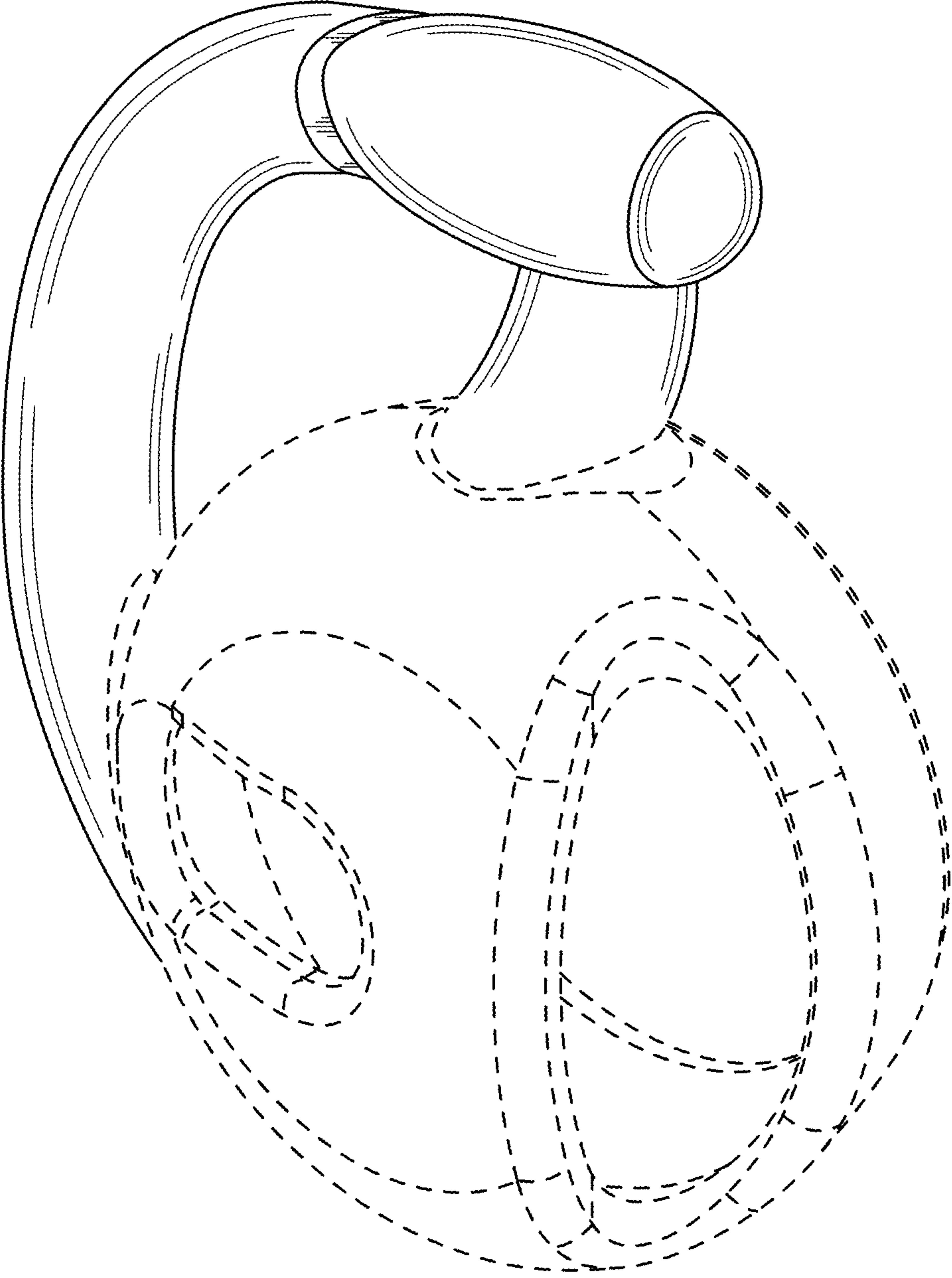

FIG. 1

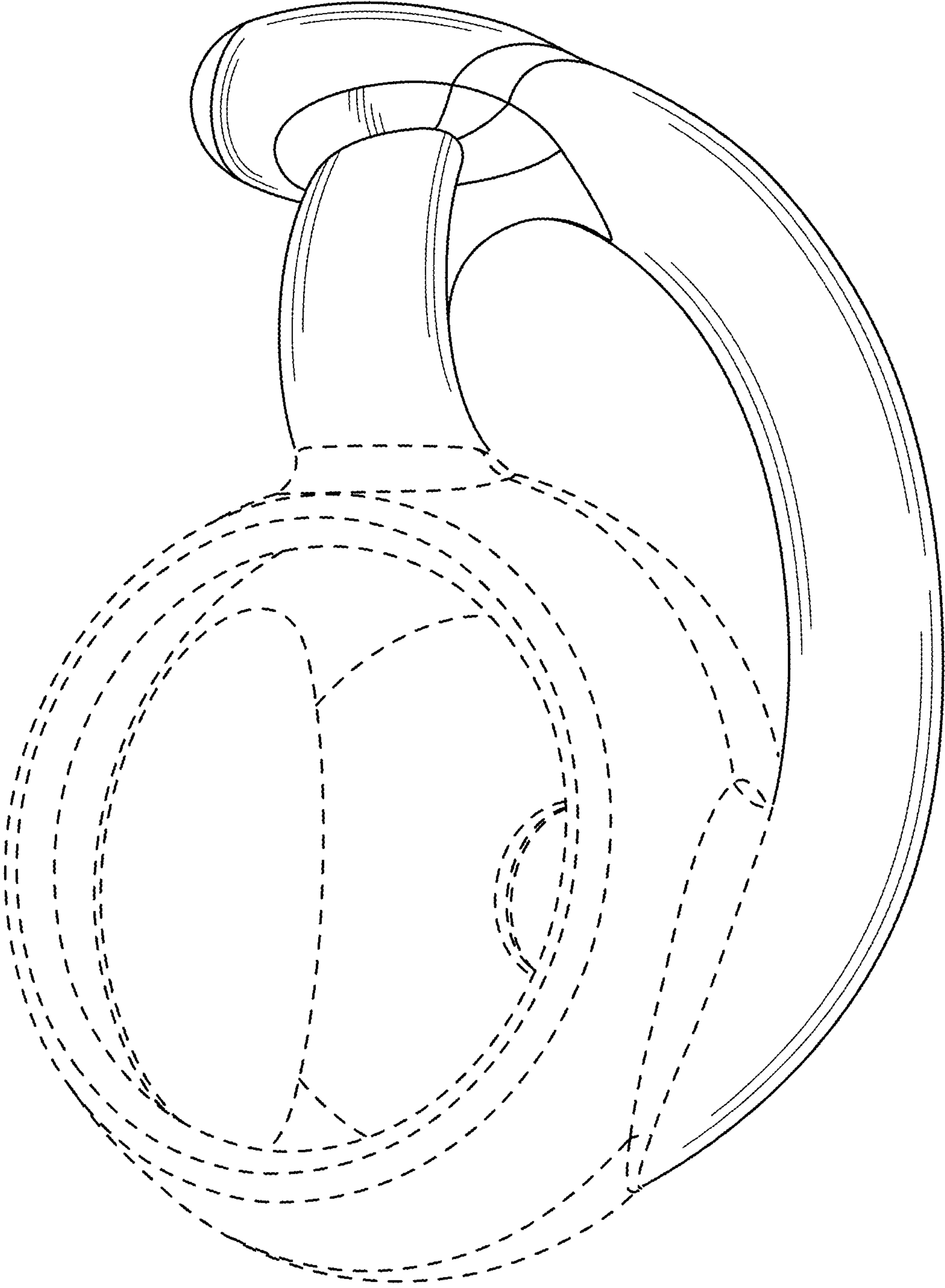

FIG. 2

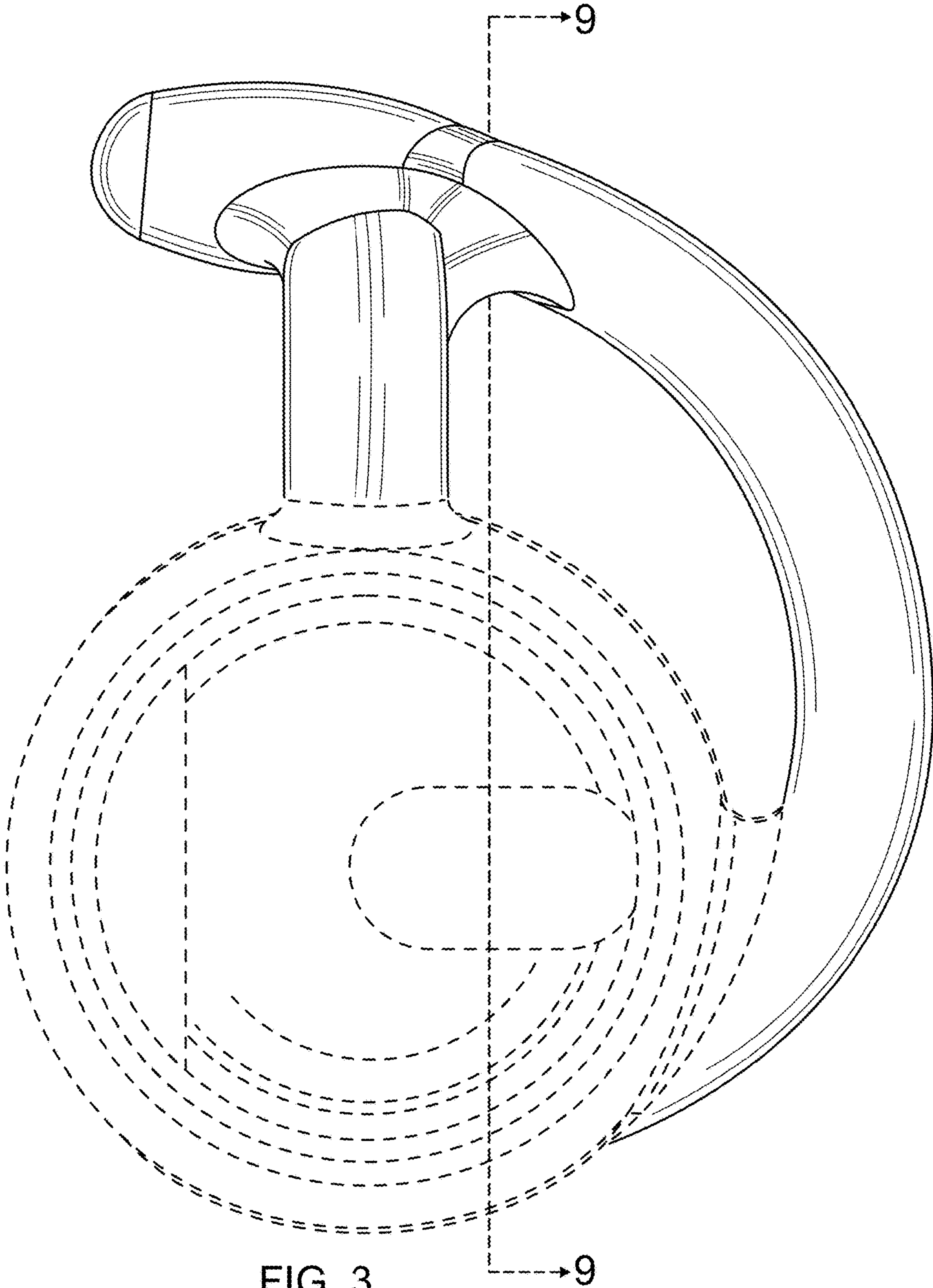

FIG. 3

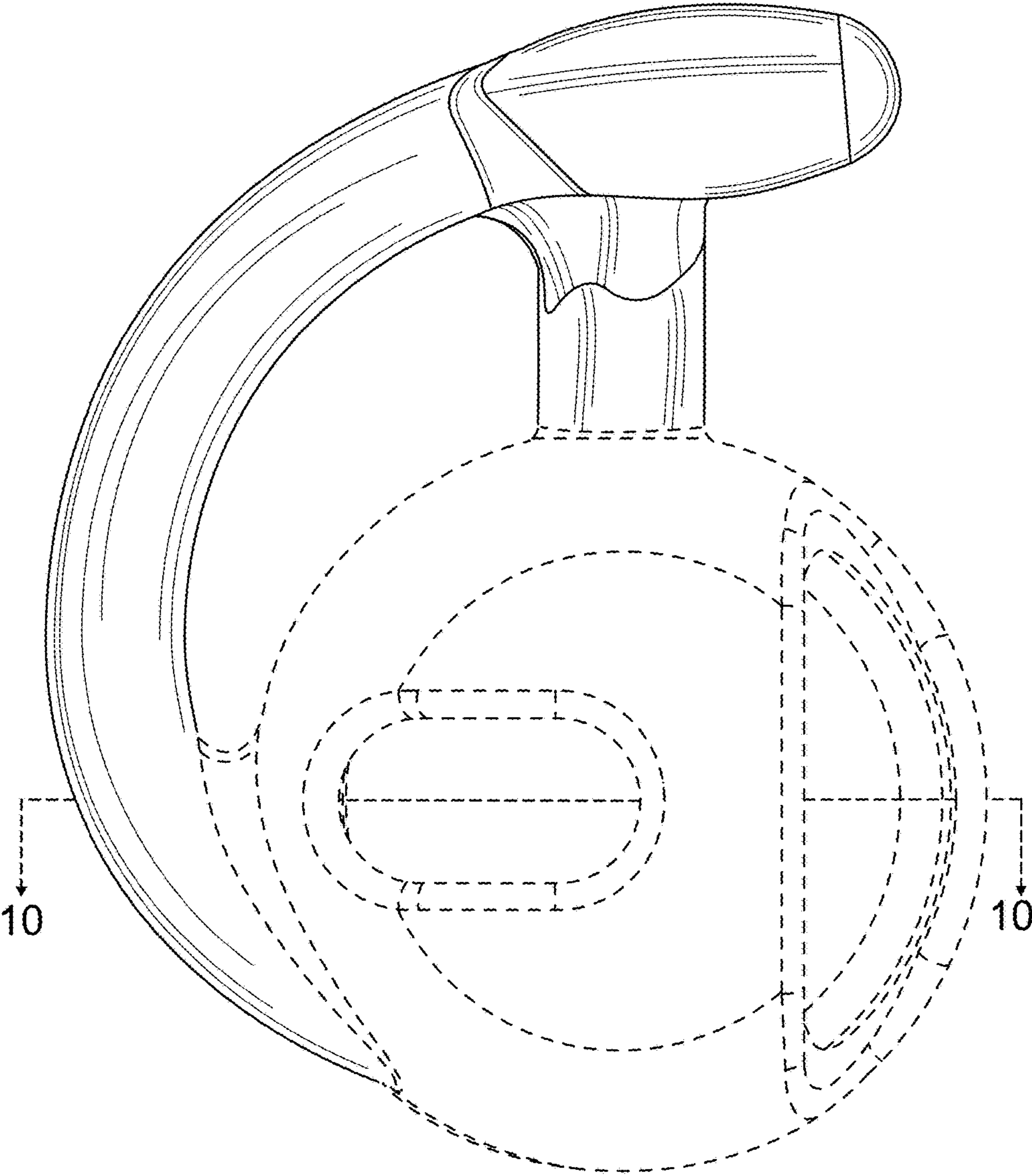

FIG. 4

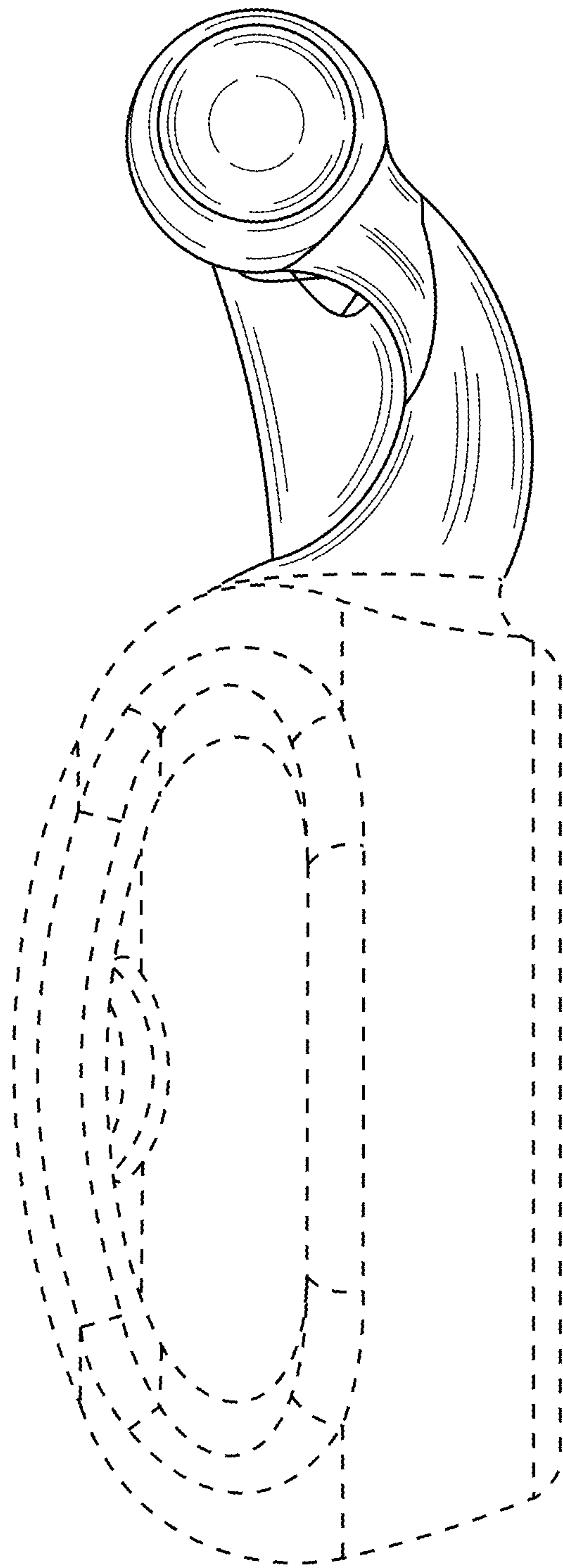

FIG. 5

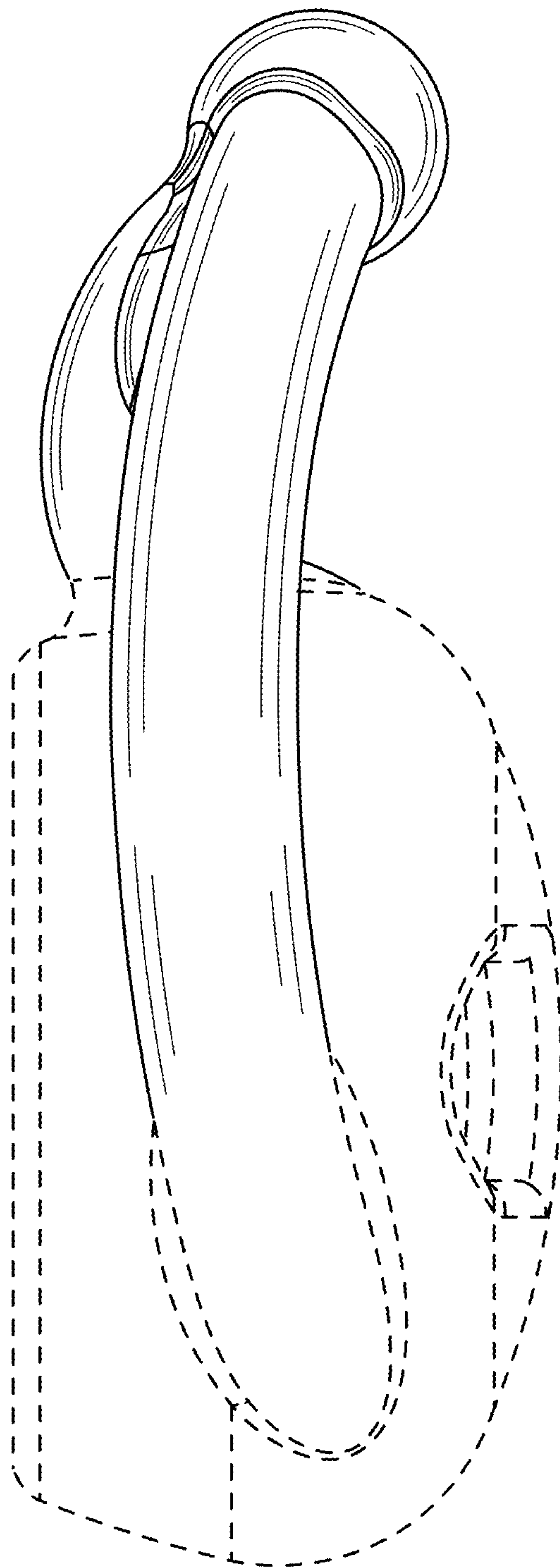

FIG. 6

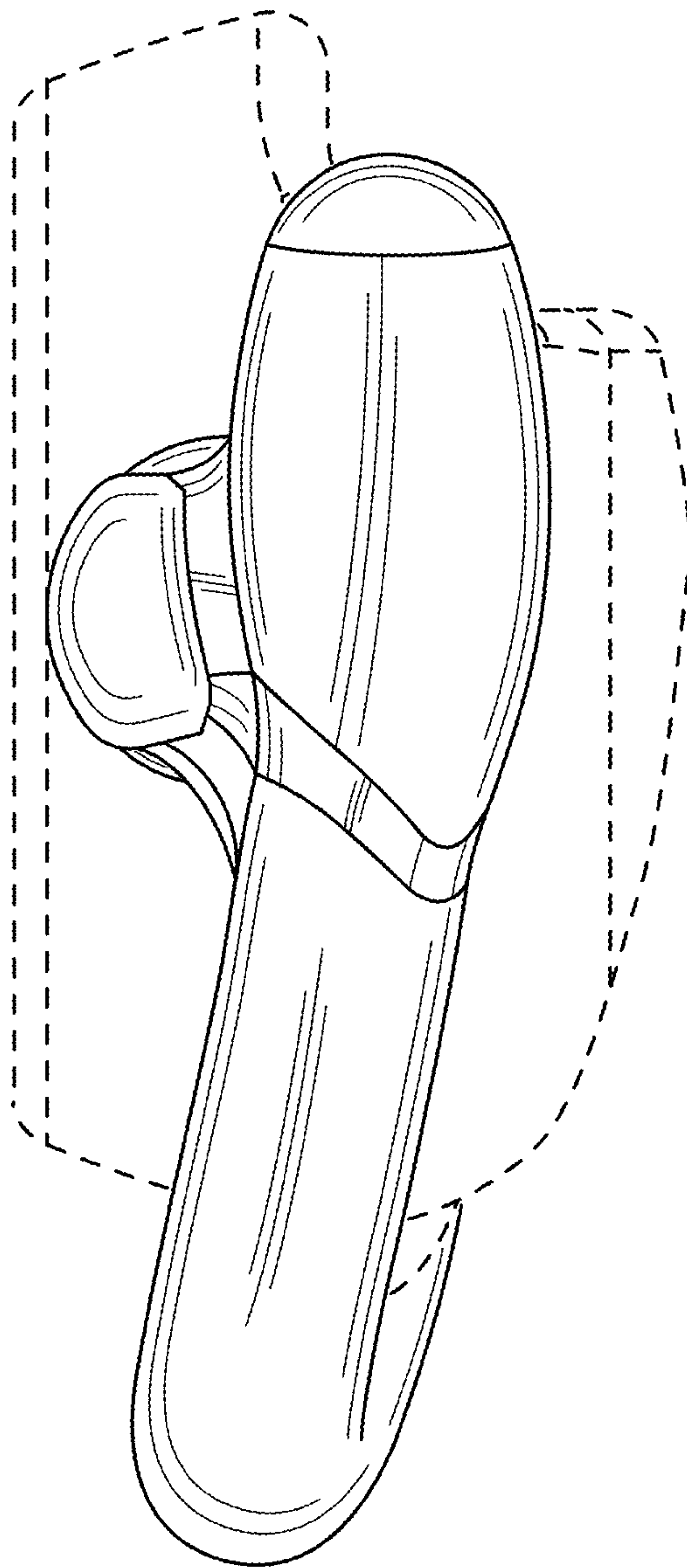

FIG. 7

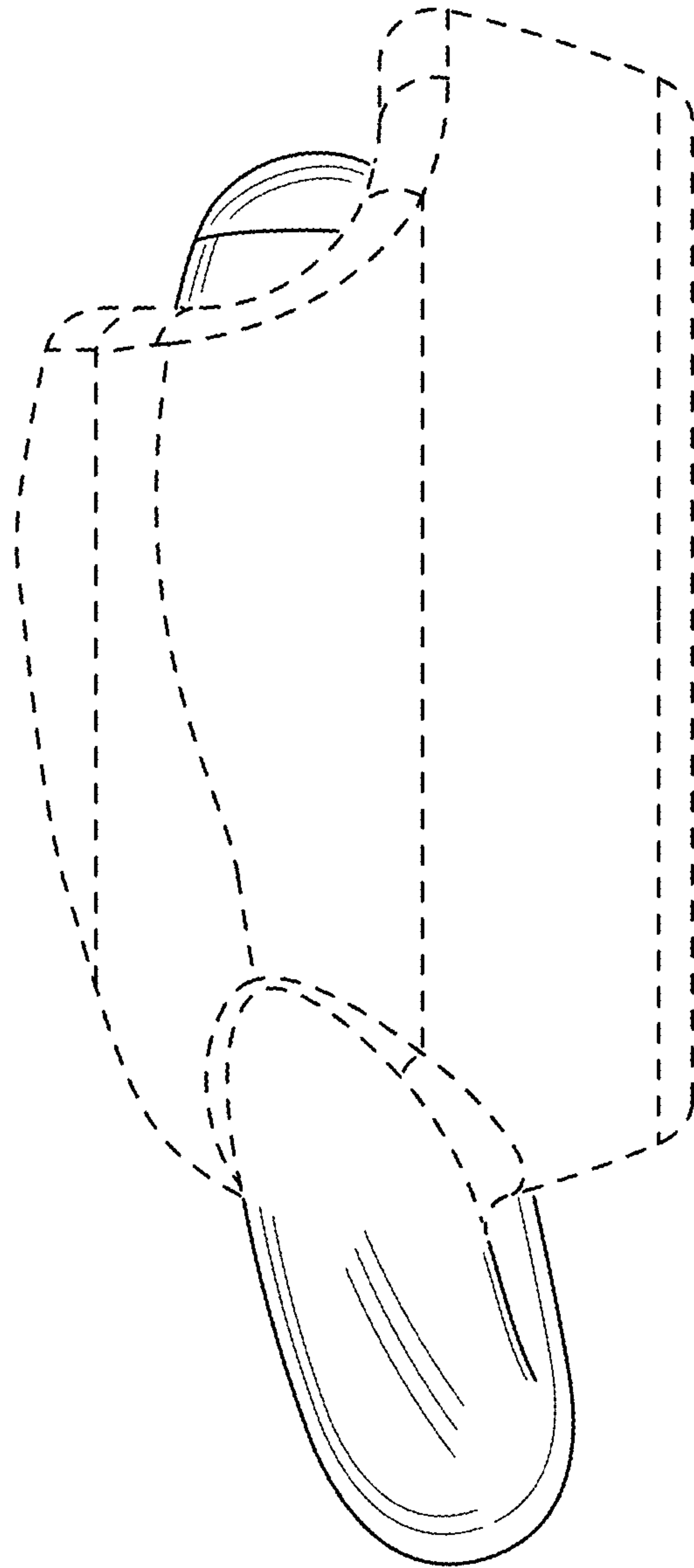

FIG. 8

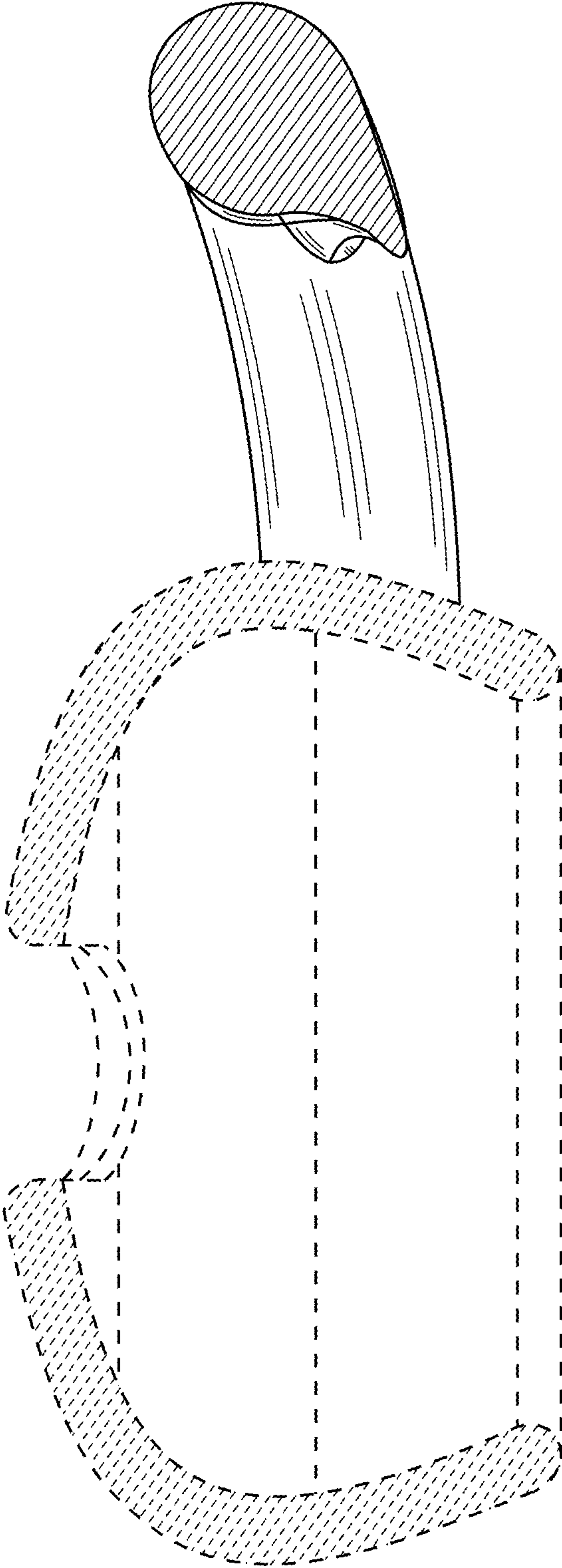

FIG. 9

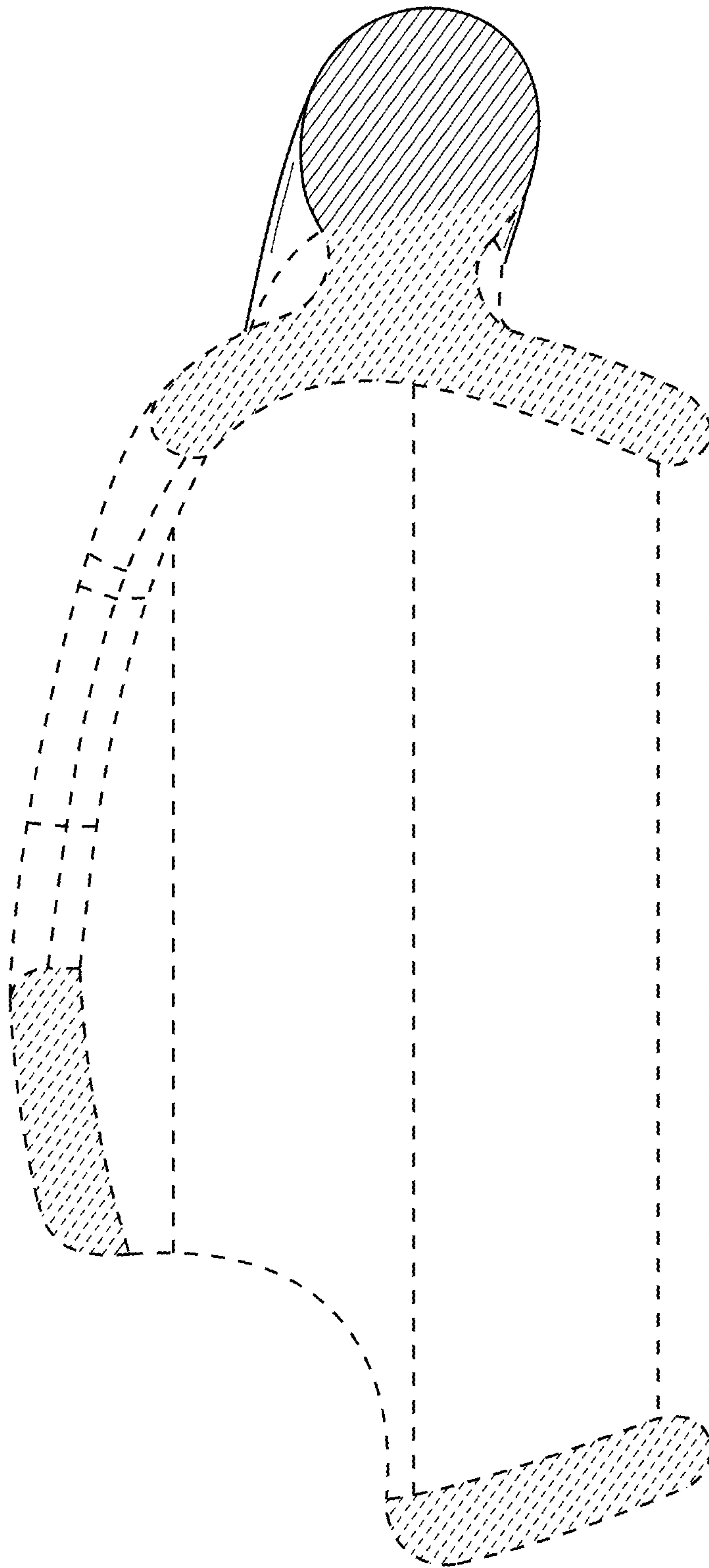

FIG. 10

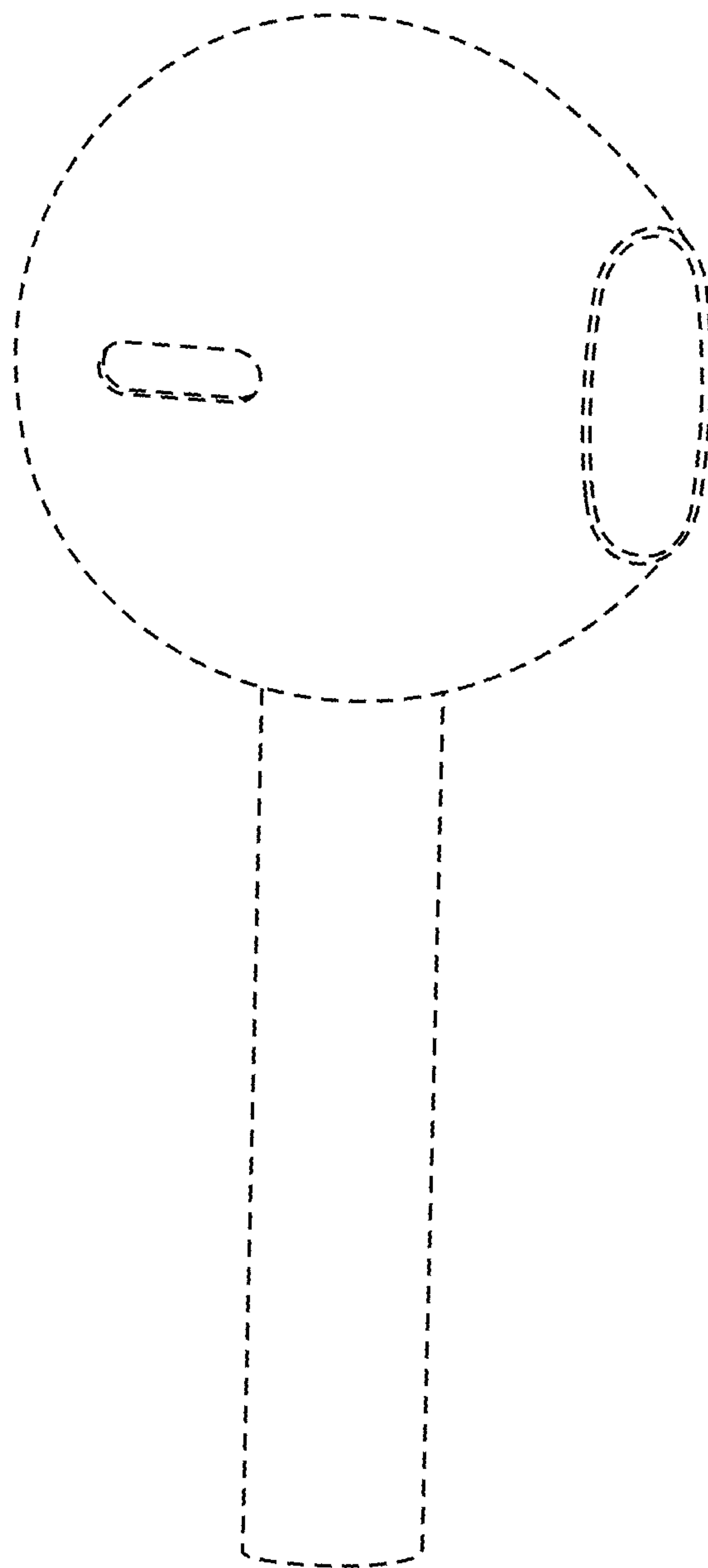

FIG. 11

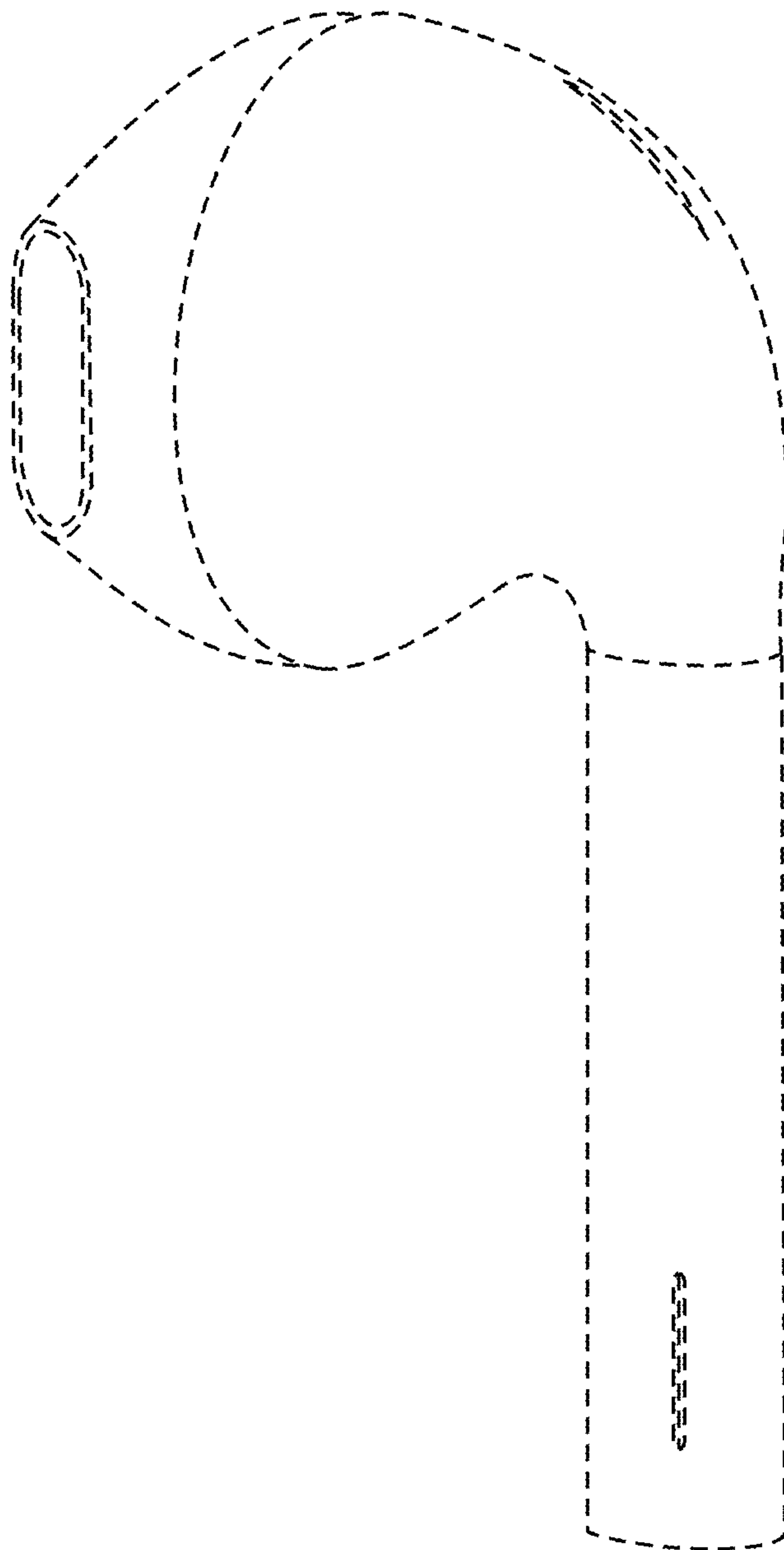

FIG. 12

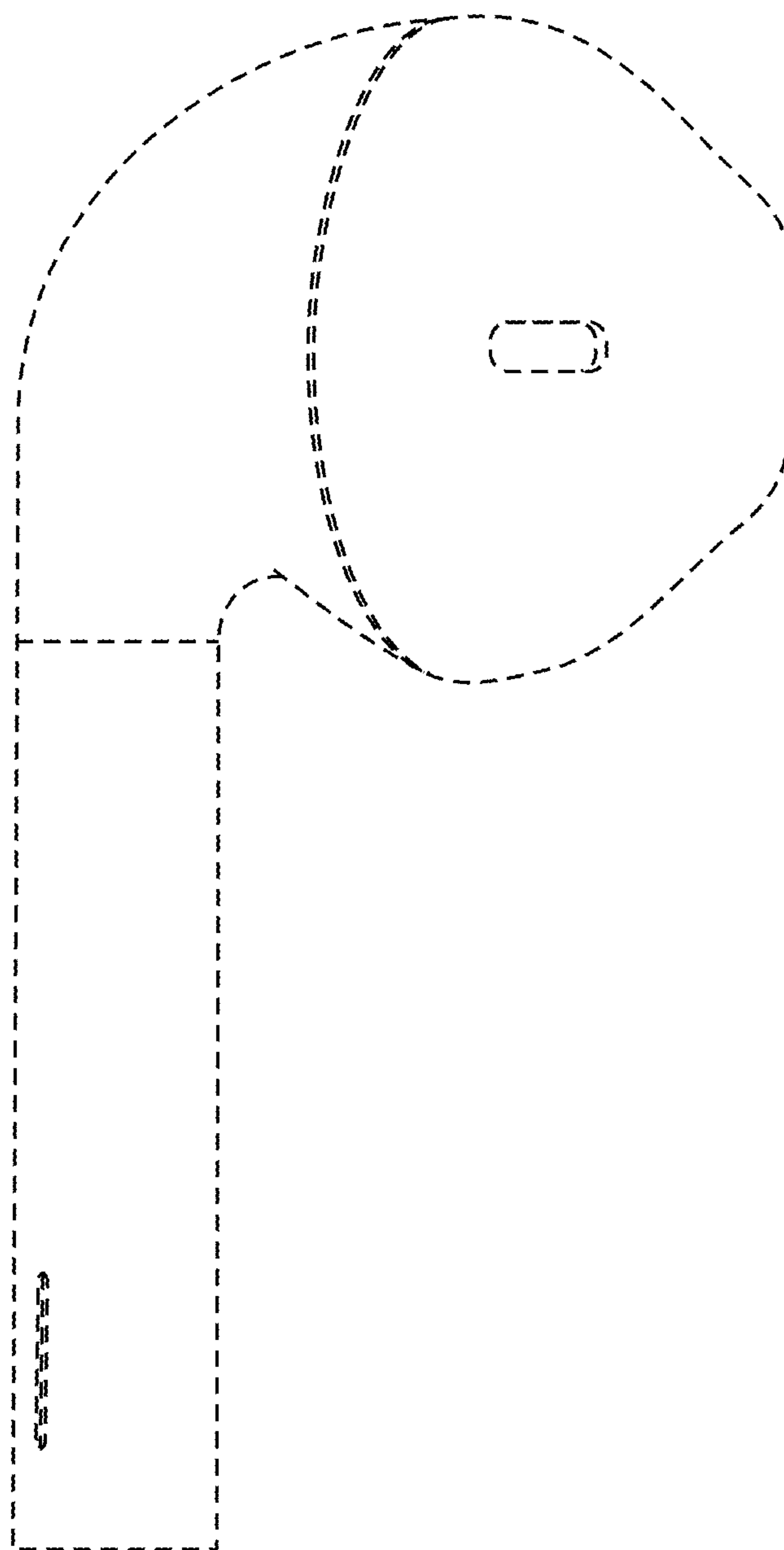

FIG. 13

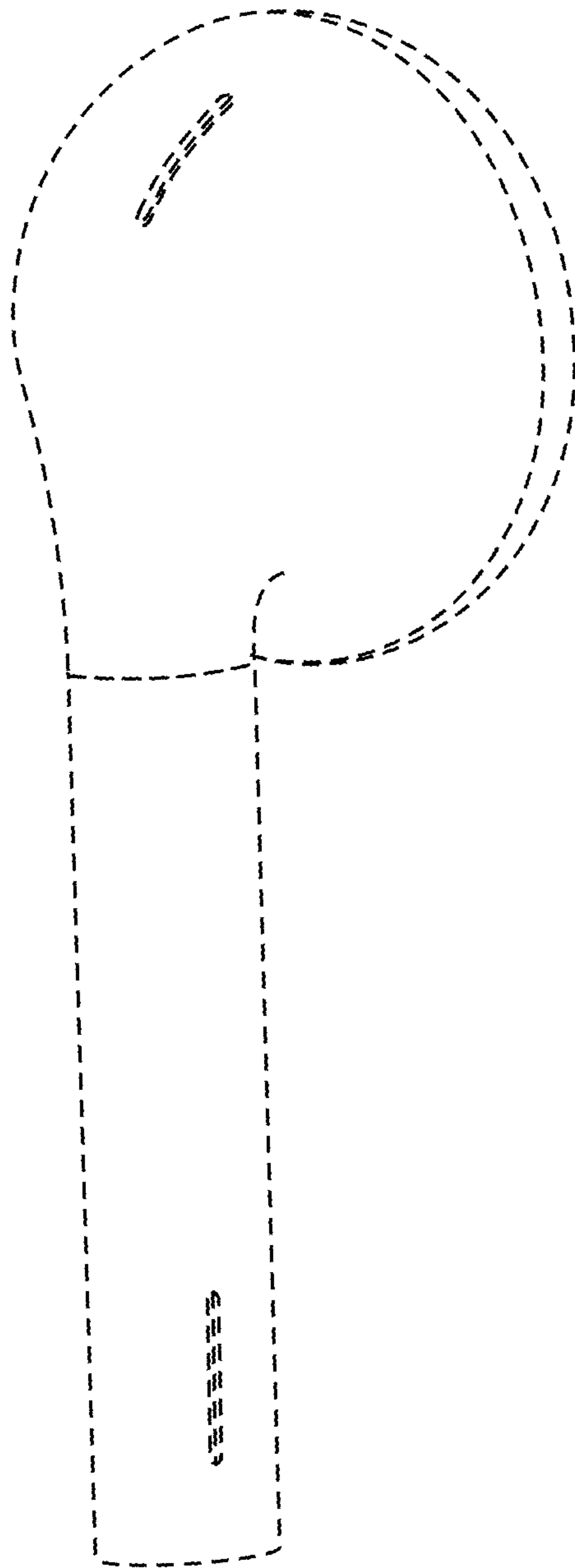

FIG. 14

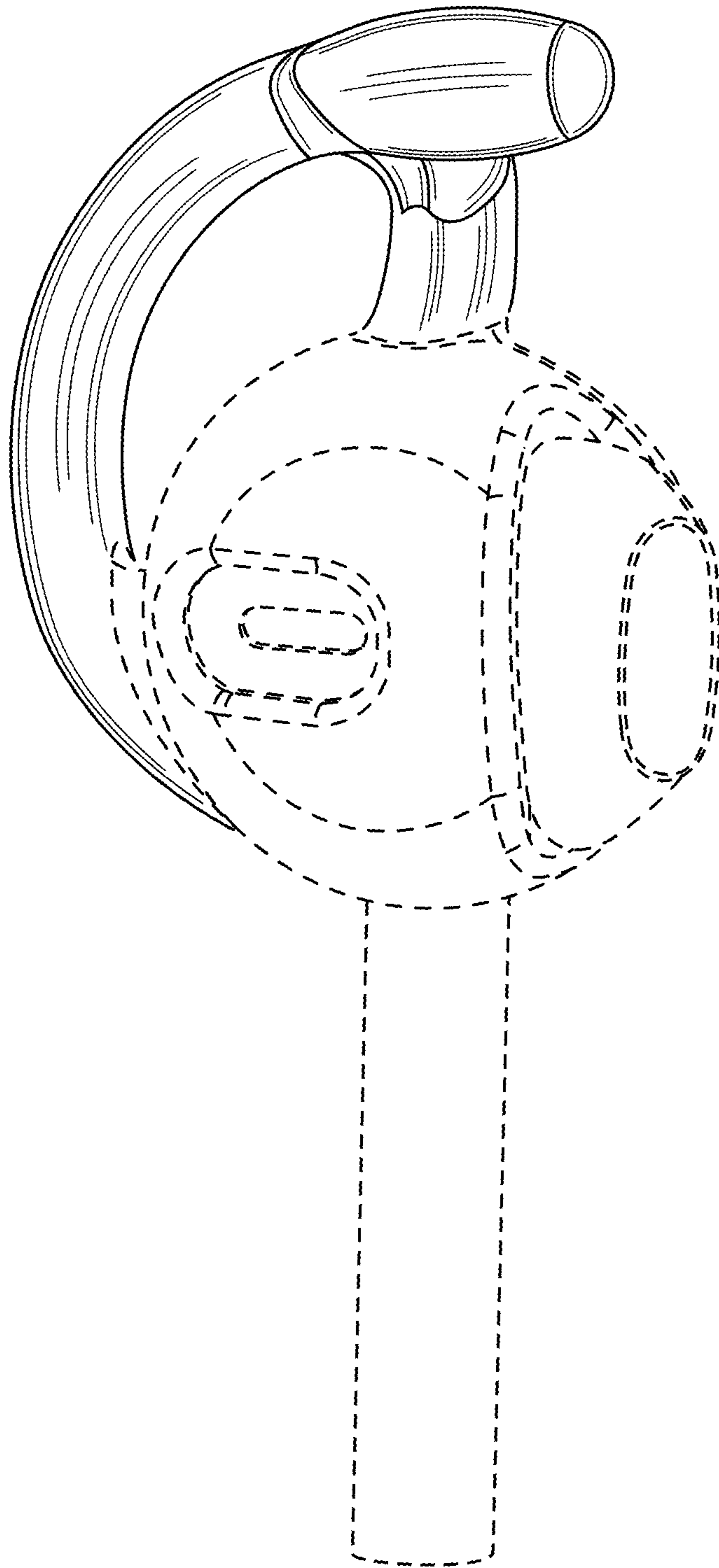

FIG. 15

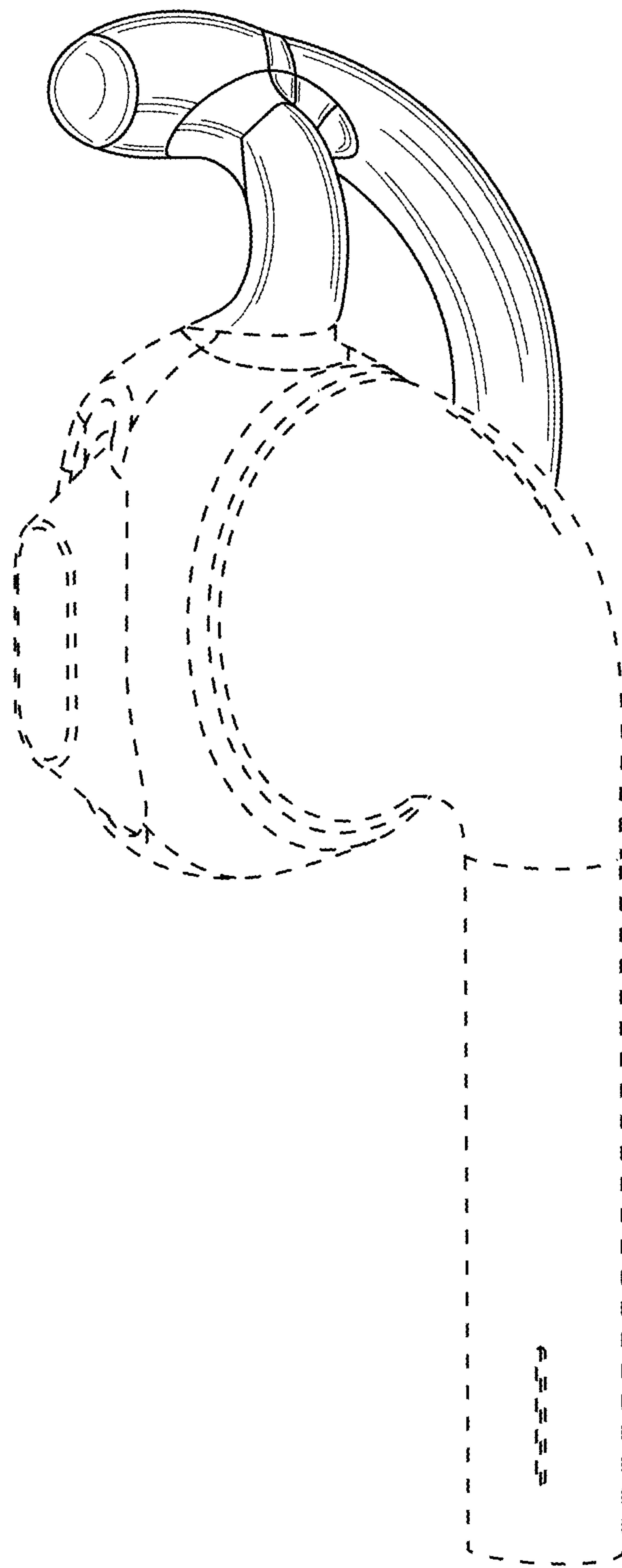

FIG. 16

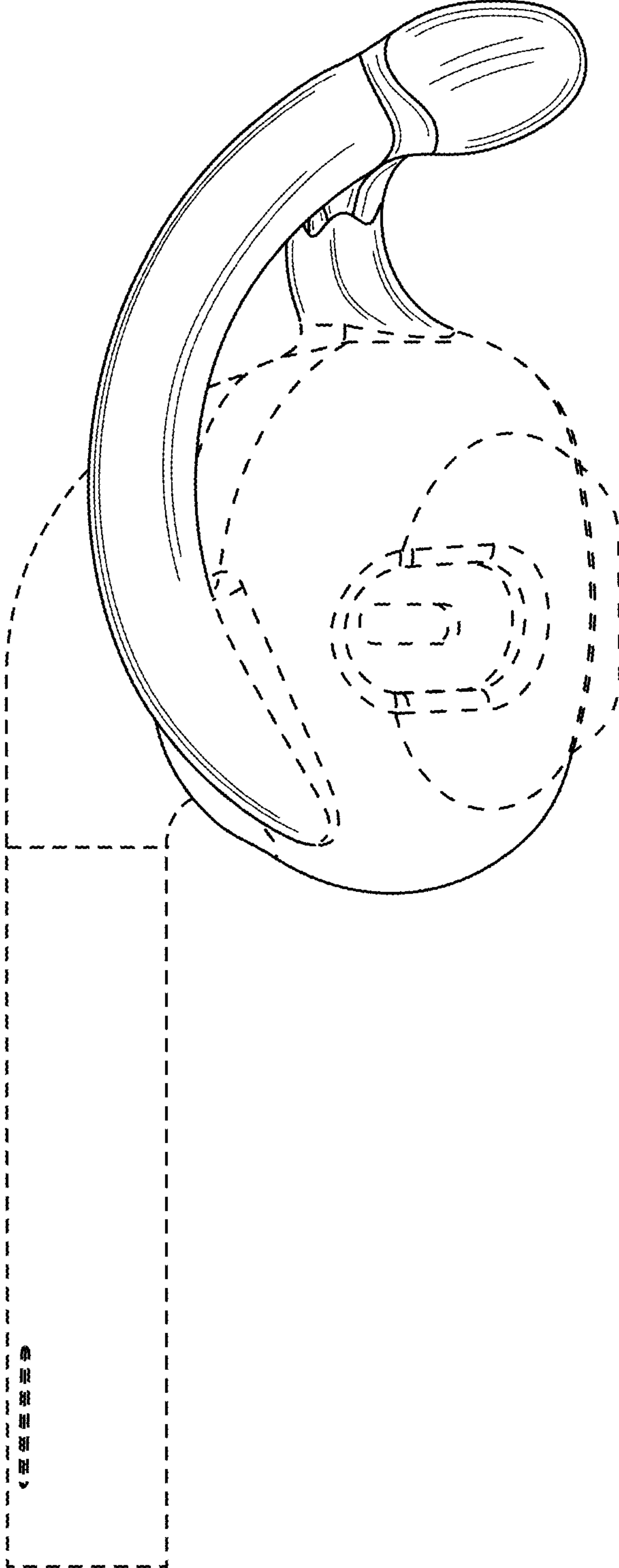

FIG. 17

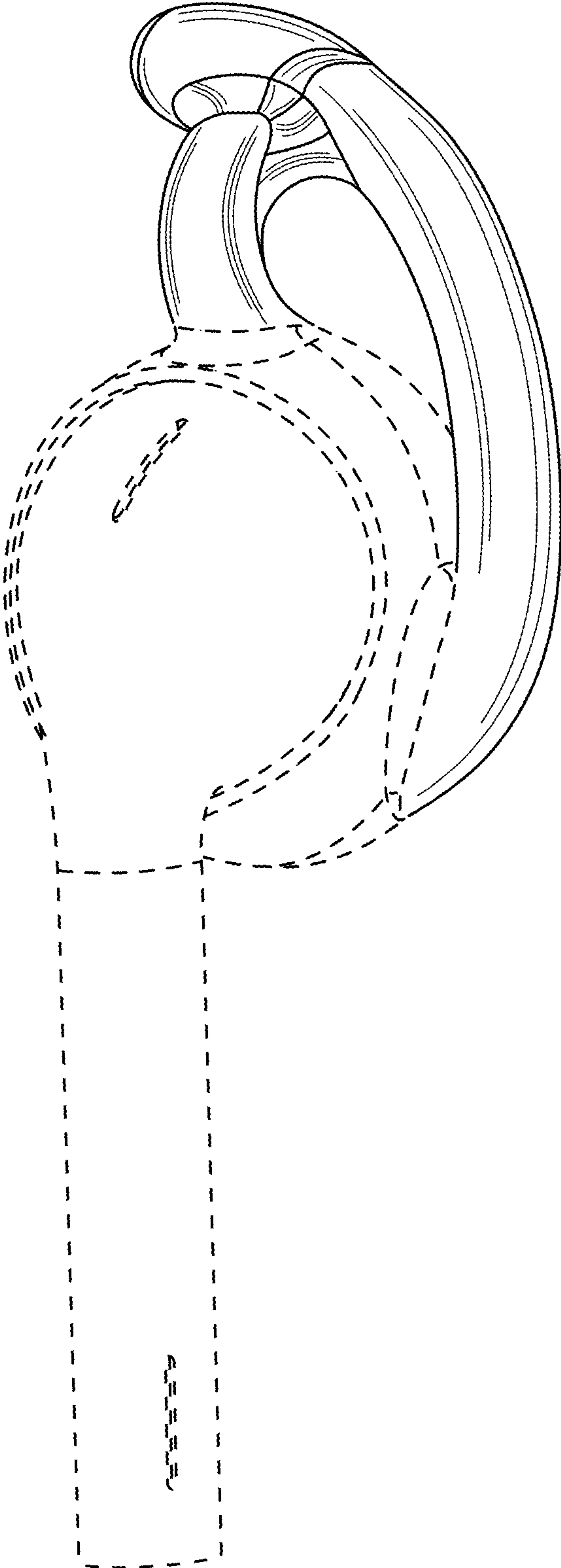

FIG. 18