



US00D846998S

(12) **United States Design Patent**  
**Bos et al.**

(10) **Patent No.:** **US D846,998 S**

(45) **Date of Patent:** **\*\* Apr. 30, 2019**

(54) **AEROSOL CONTAINER**

(71) Applicant: **Reckitt Benckiser (Brands) Limited**,  
Slough, Berkshire (GB)

(72) Inventors: **Randy Bos**, Eindhoven (NL); **Karin Dülker**, Eindhoven (NL); **Bas Groenendaal**, Eindhoven (NL); **Chloe Swaffield**, Slough (GB)

(73) Assignee: **RECKITT BENCKISER (BRANDS) LIMITED**, Slough, Berkshire (GB)

(\*\*) Term: **15 Years**

(21) Appl. No.: **29/609,953**

(22) Filed: **Jul. 7, 2017**

(30) **Foreign Application Priority Data**

Jan. 25, 2017 (EM) ..... 003707074-0001

(51) **LOC (11) Cl.** ..... **09-01**

(52) **U.S. Cl.**  
USPC ..... **D9/688**

(58) **Field of Classification Search**  
USPC ..... D9/682-694, 715, 729, 500-505,  
D9/516-575, 434-436, 443-449  
CPC ..... B65D 83/14; B65D 83/16; B65D 83/20;  
B65D 83/201; B65D 83/202; B65D  
83/203; B65D 83/205; B65D 83/206;  
B65D 83/207; B65D 83/22; B65D  
83/222; B65D 83/38; B65D 83/40; B65D  
83/75; B65D 83/752; B65D 83/753;  
B65D 83/30; B65D 83/303

See application file for complete search history.

(56) **References Cited**

**U.S. PATENT DOCUMENTS**

D190,938 S \* 7/1961 Sanborn ..... D9/448  
3,107,033 A \* 10/1963 Sanborn ..... B65D 83/205  
222/182

D206,691 S \* 1/1967 Pizzuro ..... D9/448  
D212,414 S \* 10/1968 Podall ..... D9/448  
D219,333 S \* 12/1970 Doblin ..... D9/688  
3,589,570 A \* 6/1971 Gach ..... B65D 83/205  
222/402.13  
D222,853 S \* 1/1972 Carpenter ..... D9/448  
3,913,805 A \* 10/1975 Sette ..... B65D 83/205  
222/402.11  
D255,012 S \* 5/1980 Ostrowsky ..... D9/448  
D277,648 S \* 2/1985 Jones ..... D9/445  
D313,345 S \* 1/1991 Wefler ..... D9/689  
D365,990 S \* 1/1996 McSwiggan ..... D9/448  
D378,802 S \* 4/1997 Corcoran ..... D9/448  
D414,416 S \* 9/1999 Watkins ..... D9/448  
6,318,583 B1 \* 11/2001 Owens ..... B65D 83/38  
215/384

(Continued)

**FOREIGN PATENT DOCUMENTS**

CA 2337882 A1 \* 1/2000 ..... B65D 83/206  
WO WO-2015138241 A1 \* 9/2015 ..... B65D 83/206  
WO WO-2016110641 A1 \* 7/2016 ..... B05B 1/202

*Primary Examiner* — Catherine A Tuttle

(74) *Attorney, Agent, or Firm* — Norris McLaughlin, PA

(57) **CLAIM**

The ornamental design for an aerosol container, as shown and described.

**DESCRIPTION**

FIG. 1 is a perspective view of an aerosol container, showing our new design;

FIG. 2 is a front elevation view thereof;

FIG. 3 is a rear elevation view thereof;

FIG. 4 is a right side elevation view thereof;

FIG. 5 is a left side elevation view thereof;

FIG. 6 is a top plan view thereof; and,

FIG. 7 is a bottom plan view.

**1 Claim, 4 Drawing Sheets**

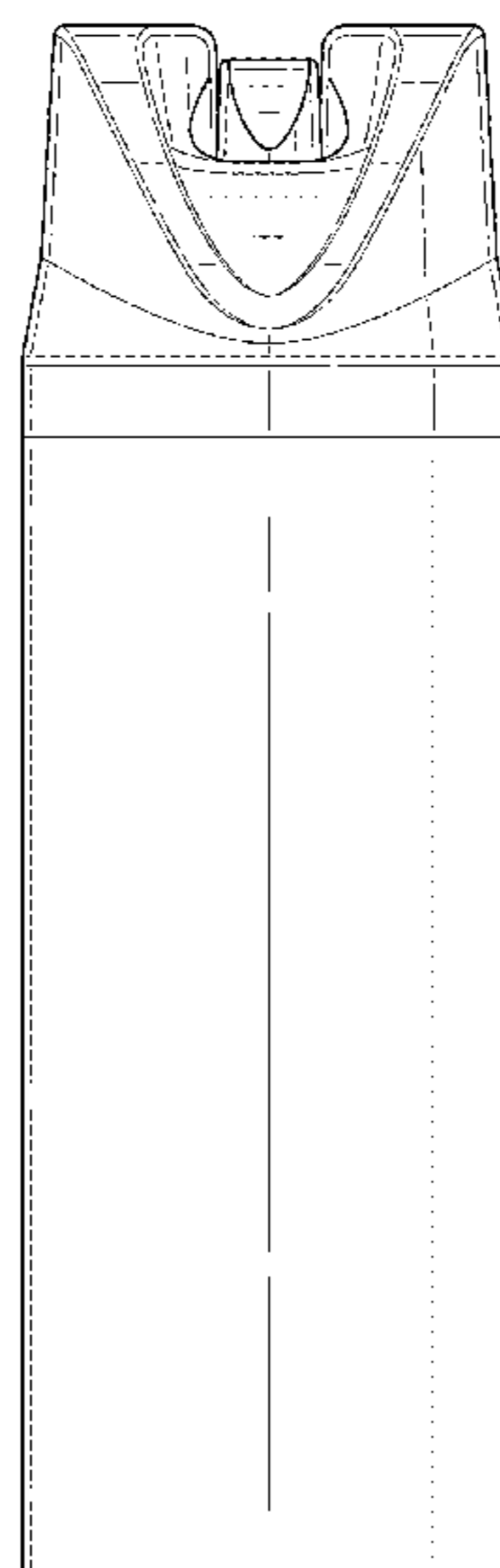
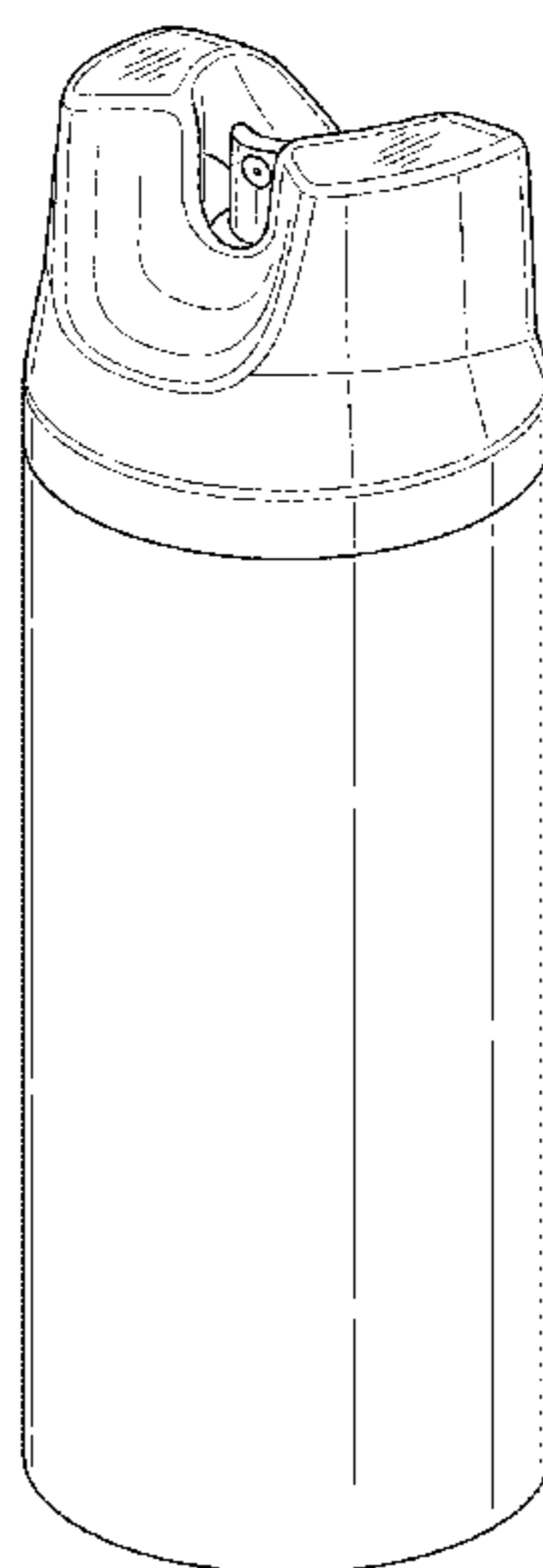

(56)

**References Cited**

U.S. PATENT DOCUMENTS

6,817,493 B1 \* 11/2004 Parsons ..... B05B 1/14  
222/330  
D529,381 S \* 10/2006 Castillo Higareda ..... D9/448  
D654,808 S \* 2/2012 Gidlow ..... D9/688  
D690,604 S \* 10/2013 Seng ..... D9/690  
D749,951 S \* 2/2016 Sims ..... D9/690  
2002/0108972 A1 \* 8/2002 Bayer ..... B65D 83/206  
222/402.13  
2008/0075522 A1 \* 3/2008 Ito ..... A46B 11/0006  
401/143

\* cited by examiner

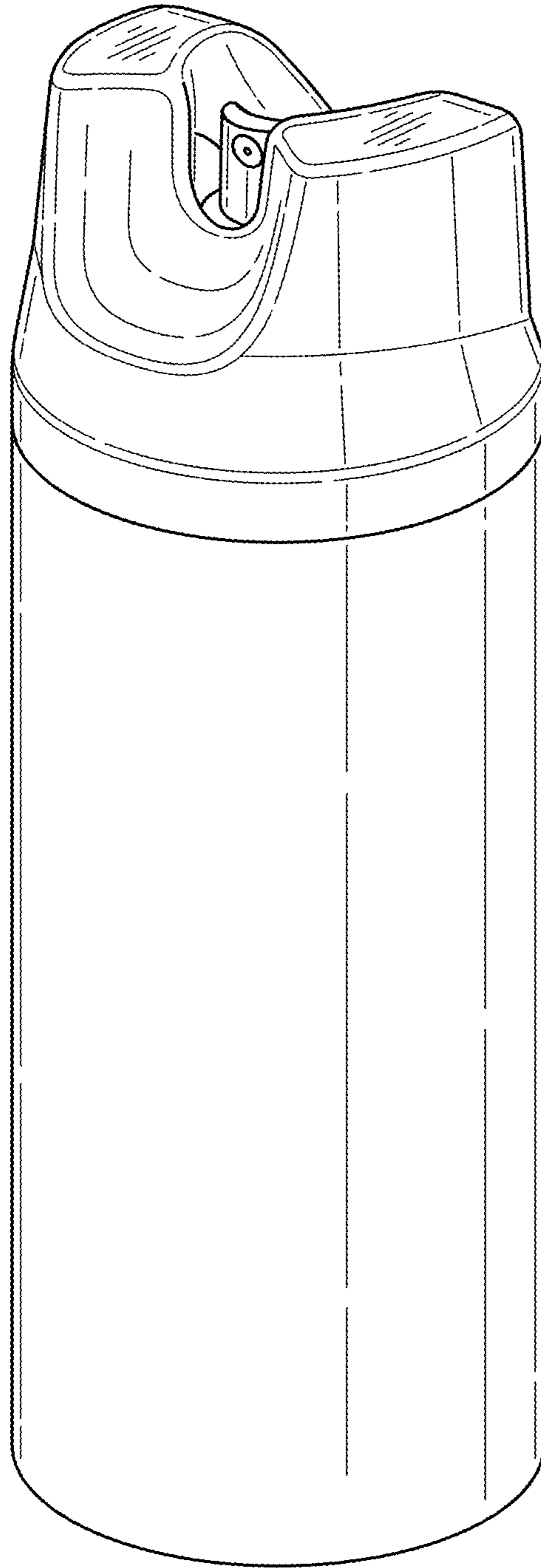

Fig. 1

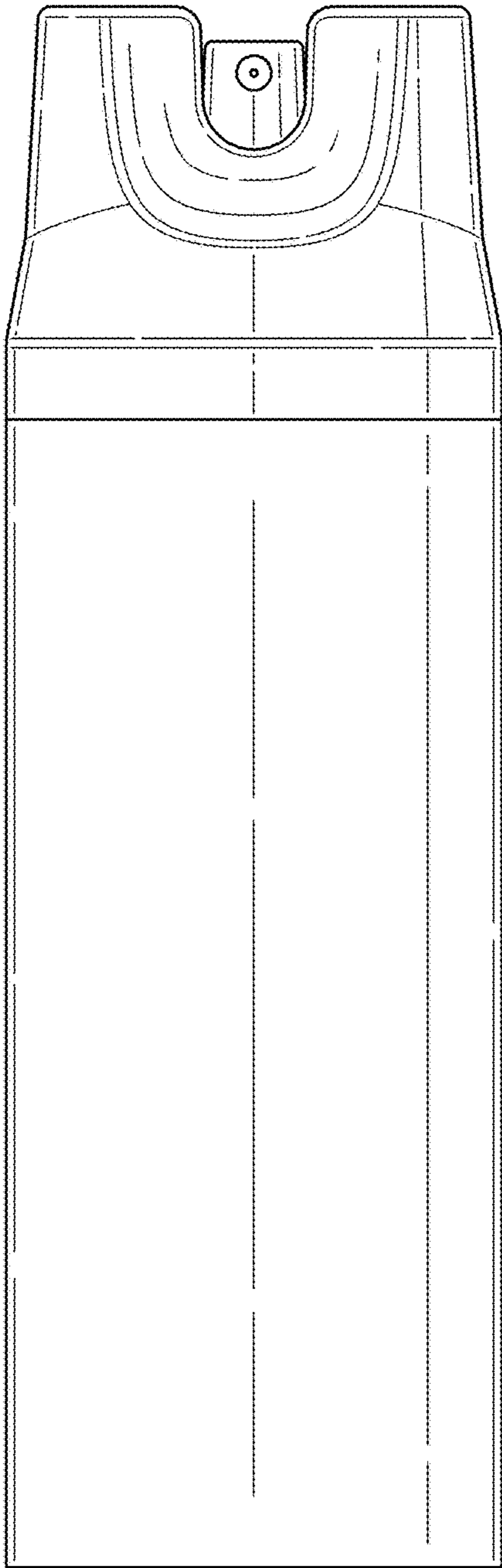

Fig. 2

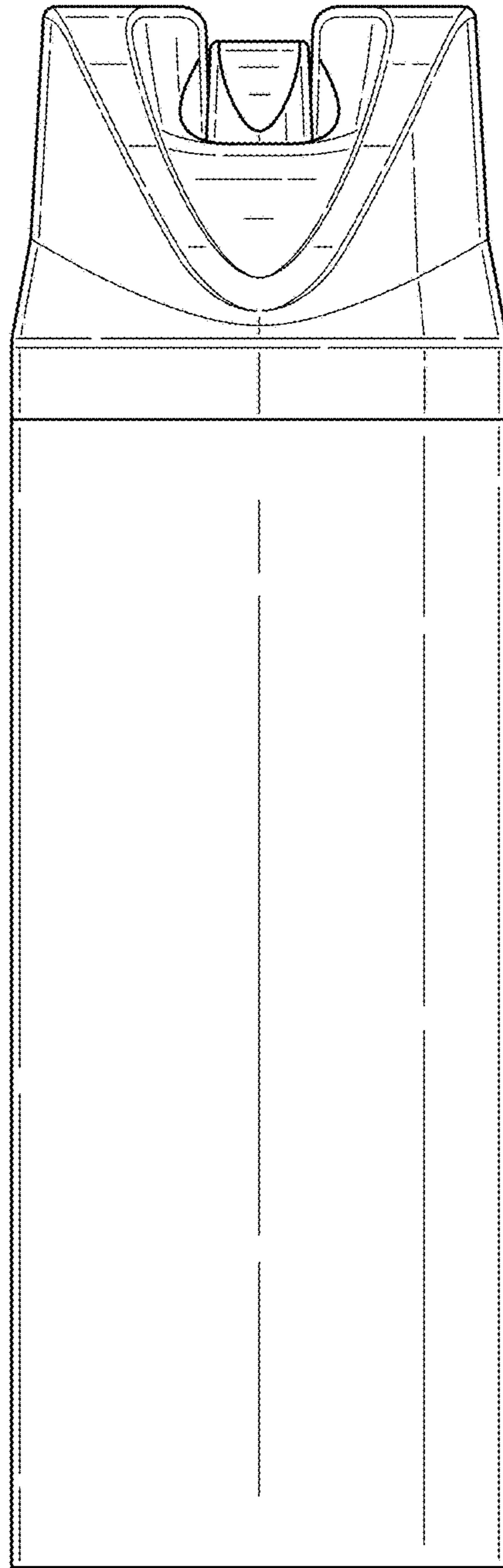

Fig. 3

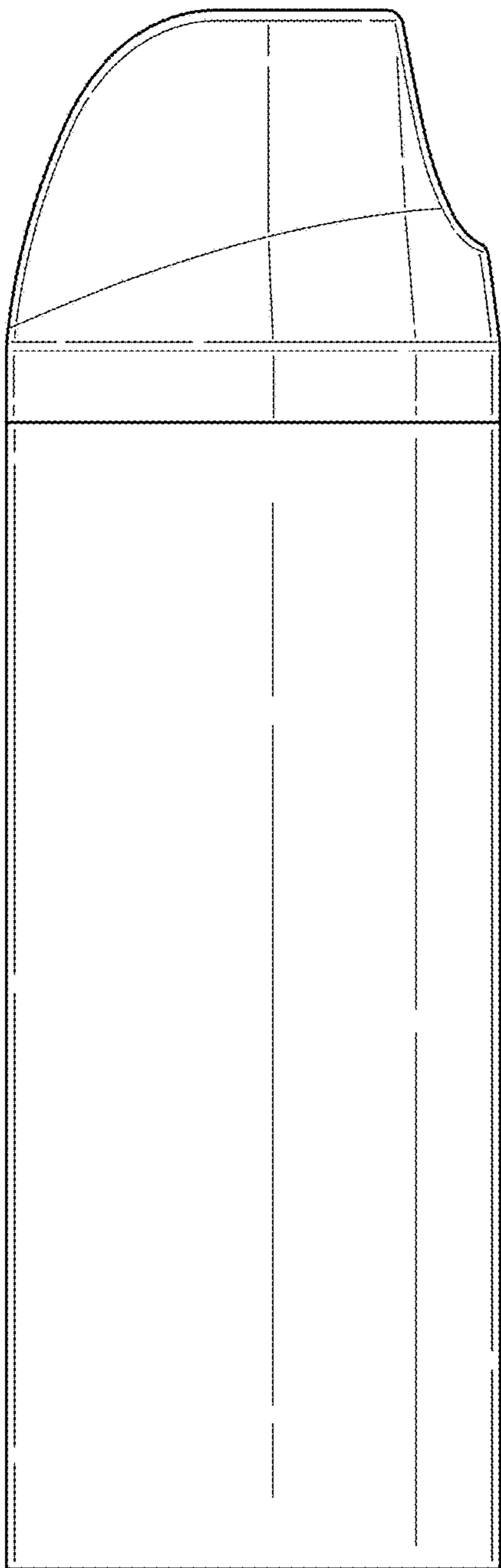

Fig. 4

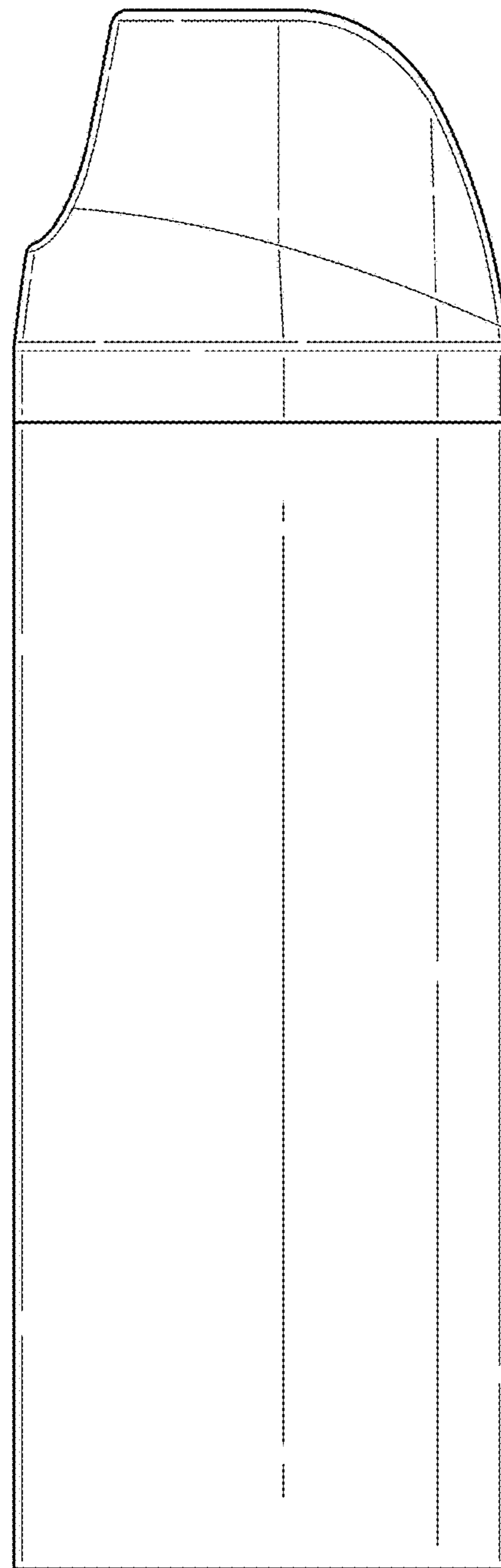

Fig. 5

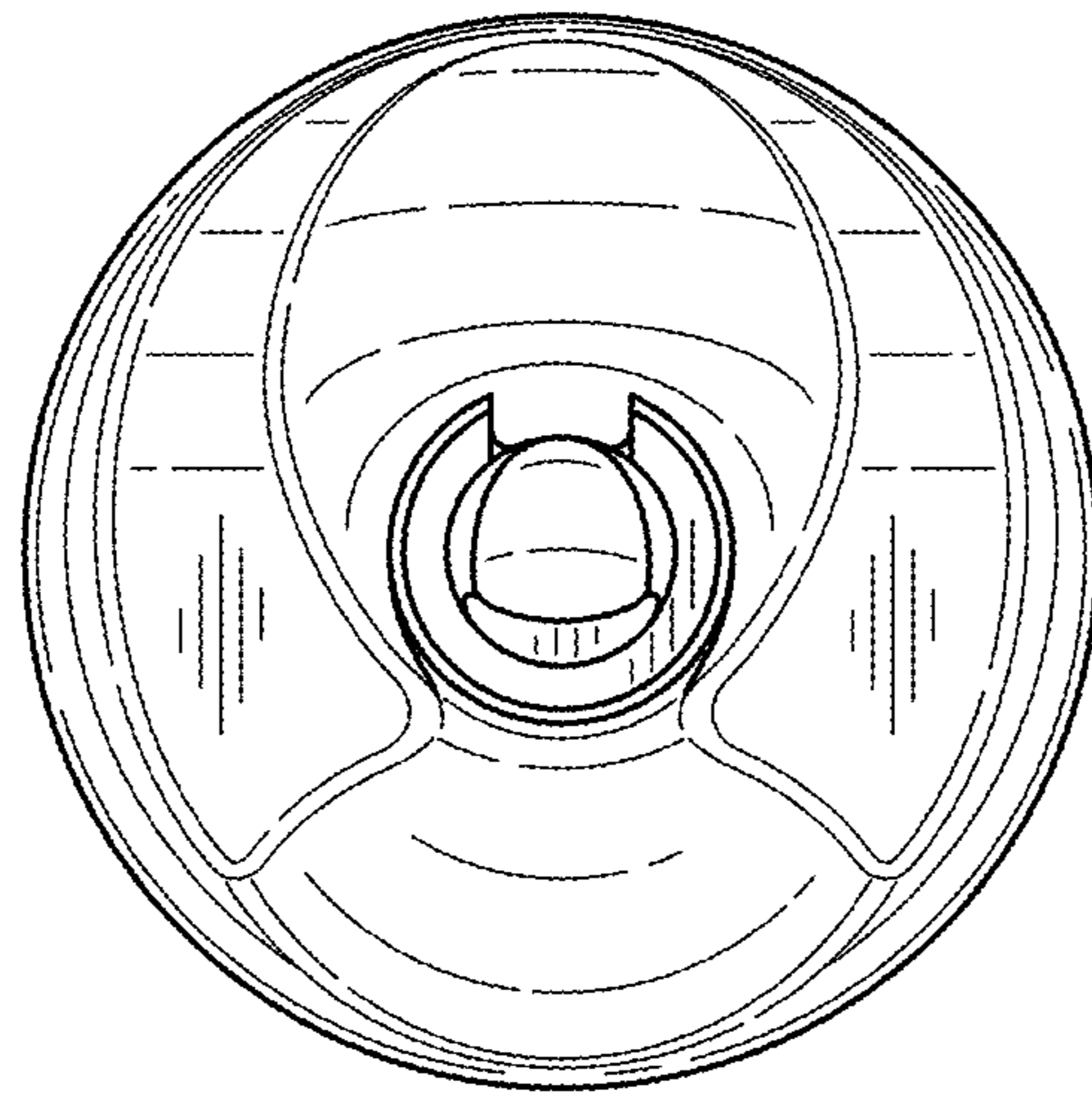

Fig. 6

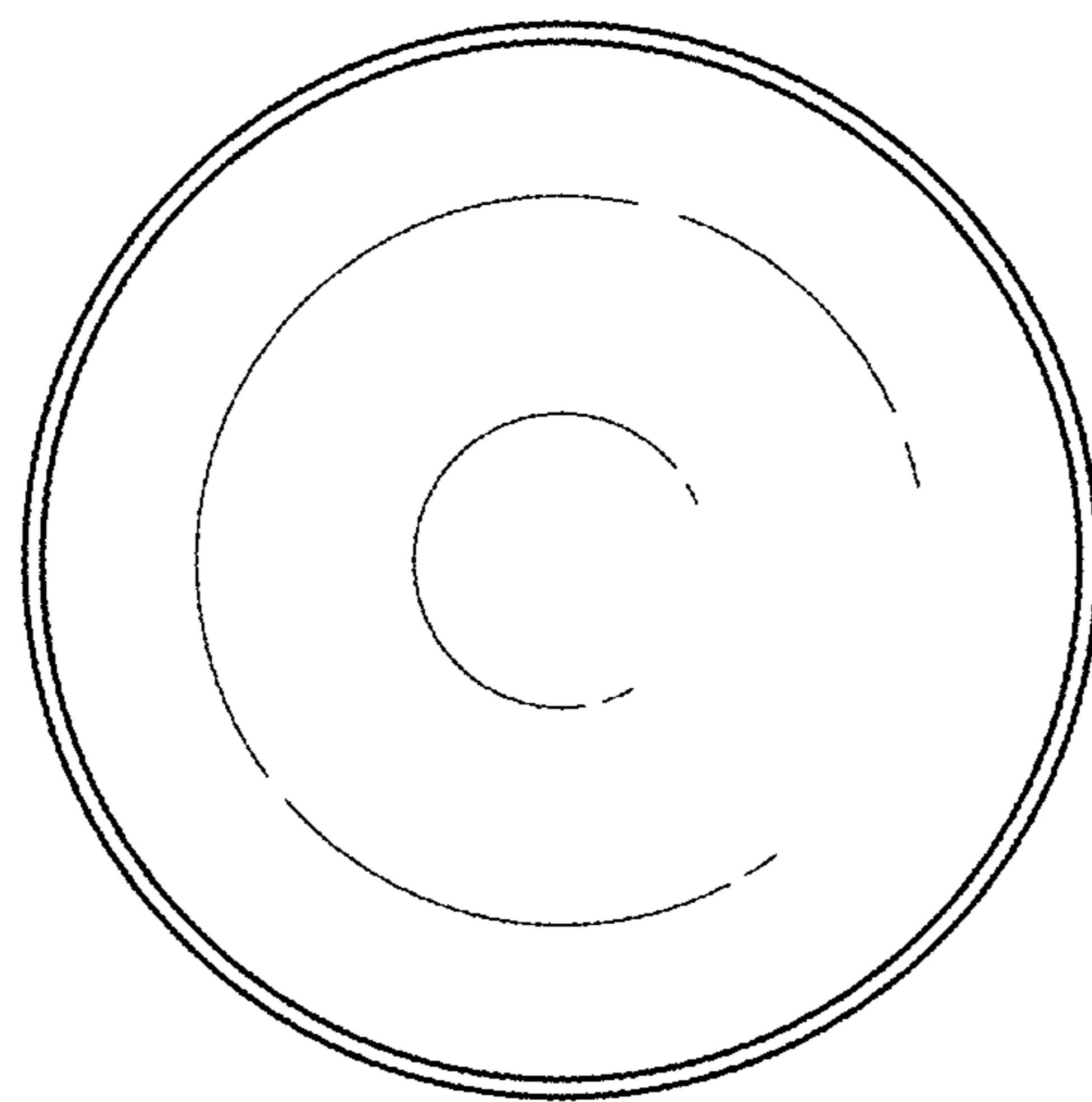

Fig. 7