



US00D846913S

(12) **United States Design Patent** (10) **Patent No.:** **US D846,913 S**
Liu (45) **Date of Patent:** **** Apr. 30, 2019**

(54) **INFLATABLE NECK PILLOW**

(71) Applicant: **Guangdong Travelmall Health Technology Co., Ltd., Dongguan (CN)**

(72) Inventor: **Zhiming Liu, Dongguan (CN)**

(73) Assignee: **GUANGDONG TRAVELMALL HEALTH TECHNOLOGY CO., LTD., Dongguan (CN)**

(**) Term: **15 Years**

(21) Appl. No.: **29/636,894**

(22) Filed: **Feb. 12, 2018**

(51) **LOC (11) Cl.** **06-09**

(52) **U.S. Cl.**
USPC **D6/601**

(58) **Field of Classification Search**

USPC D6/596, 597, 599, 601
CPC A47G 9/10; A47G 9/1027; A47G 9/1054;
A47G 9/1072; A47G 9/1081; A47G
9/109; A47G 2009/1018

See application file for complete search history.

(56) **References Cited**

U.S. PATENT DOCUMENTS

- D787,232 S * 5/2017 Kassab Arabo D6/601
- D787,233 S * 5/2017 Wang D6/601
- D791,508 S * 7/2017 Chen D6/601
- D807,653 S * 1/2018 Roizner D6/334
- D823,027 S * 7/2018 Zou D6/601
- D834,350 S * 11/2018 Zou D6/601
- 2014/0310877 A1 * 10/2014 Sternlight A47G 9/10
5/639
- 2017/0164754 A1 * 6/2017 Alletto, Jr. A47C 20/023

OTHER PUBLICATIONS

Tinglear. <https://tinglear.com/product/airplane-inflatable-neck-pillow/>. "U-Shaped Travel Inflatable Neck Pillow". Date unknown: Viewed: Dec. 2018 (Year: 2018).*

Amazon. <https://www.amazon.com/Jerrybox-Inflatable-Support-Cushion-Fastest/dp/B0723HSQZY>. "Jerrybox Travel Neck Pillow". Date Unknown: Viewed Dec. 2018 (Year: 2018).*

* cited by examiner

Primary Examiner — R. Johnson

(74) *Attorney, Agent, or Firm* — Shimokaji IP

(57) **CLAIM**

The ornamental design for an inflatable neck pillow, as shown and described.

DESCRIPTION

FIG. 1 is a front elevation view of an inflatable neck pillow according to a first embodiment;
 FIG. 2 is a rear elevation view of FIG. 1;
 FIG. 3 is a left side elevation view of FIG. 1;
 FIG. 4 is a right side elevation view of FIG. 1;
 FIG. 5 is a top plan view of FIG. 1;
 FIG. 6 is a bottom plan view of FIG. 1;
 FIG. 7 is a perspective view of FIG. 1;
 FIG. 8 is a front elevation view of an inflatable neck pillow according to a second embodiment;
 FIG. 9 is a rear elevation view of FIG. 8;
 FIG. 10 is a left side elevation view of FIG. 8;
 FIG. 11 is a right side elevation view of FIG. 8;
 FIG. 12 is a top plan view of FIG. 8;
 FIG. 13 is a bottom plan view of FIG. 8; and,
 FIG. 14 is a perspective view of FIG. 8.

1 Claim, 10 Drawing Sheets

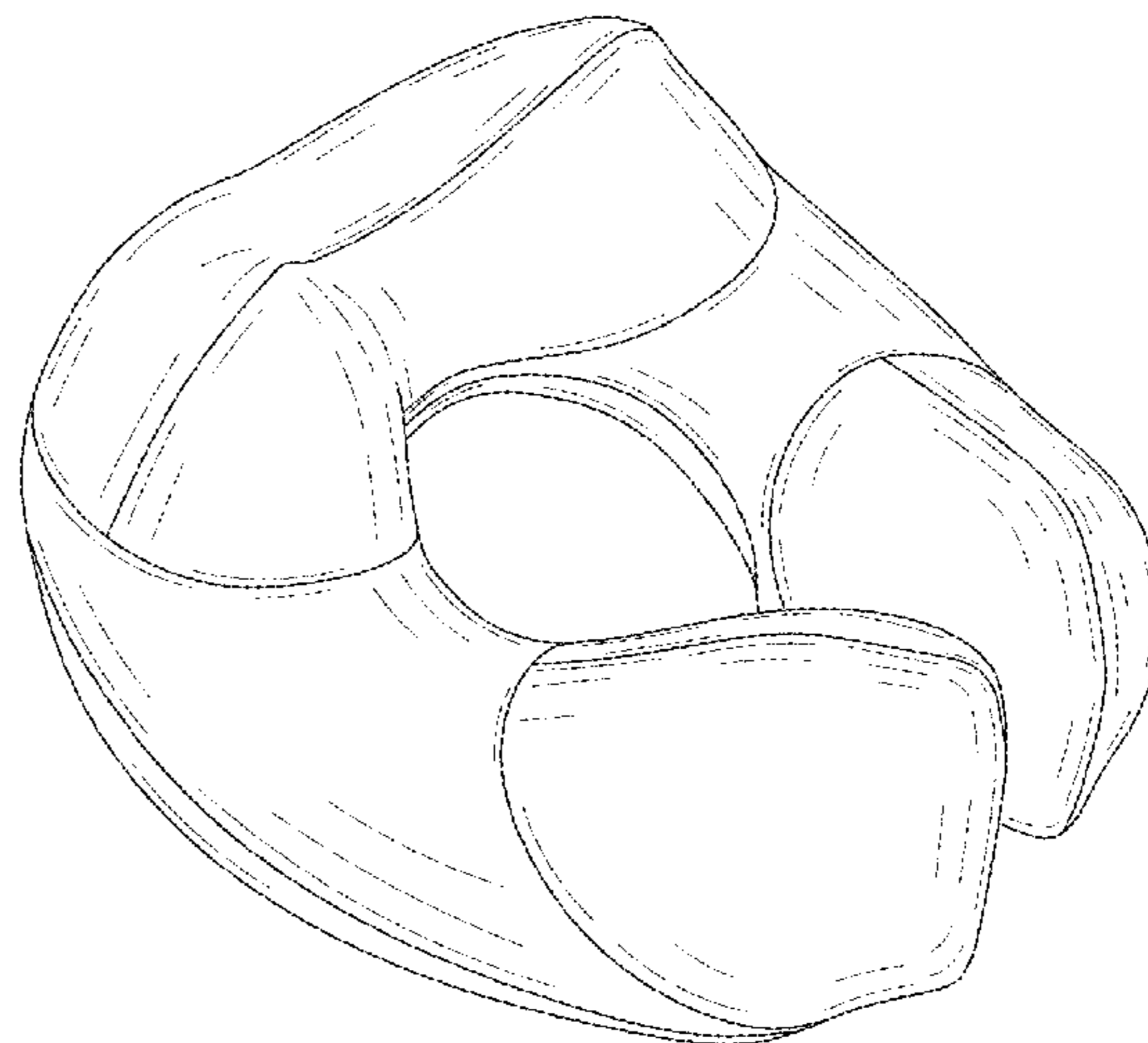
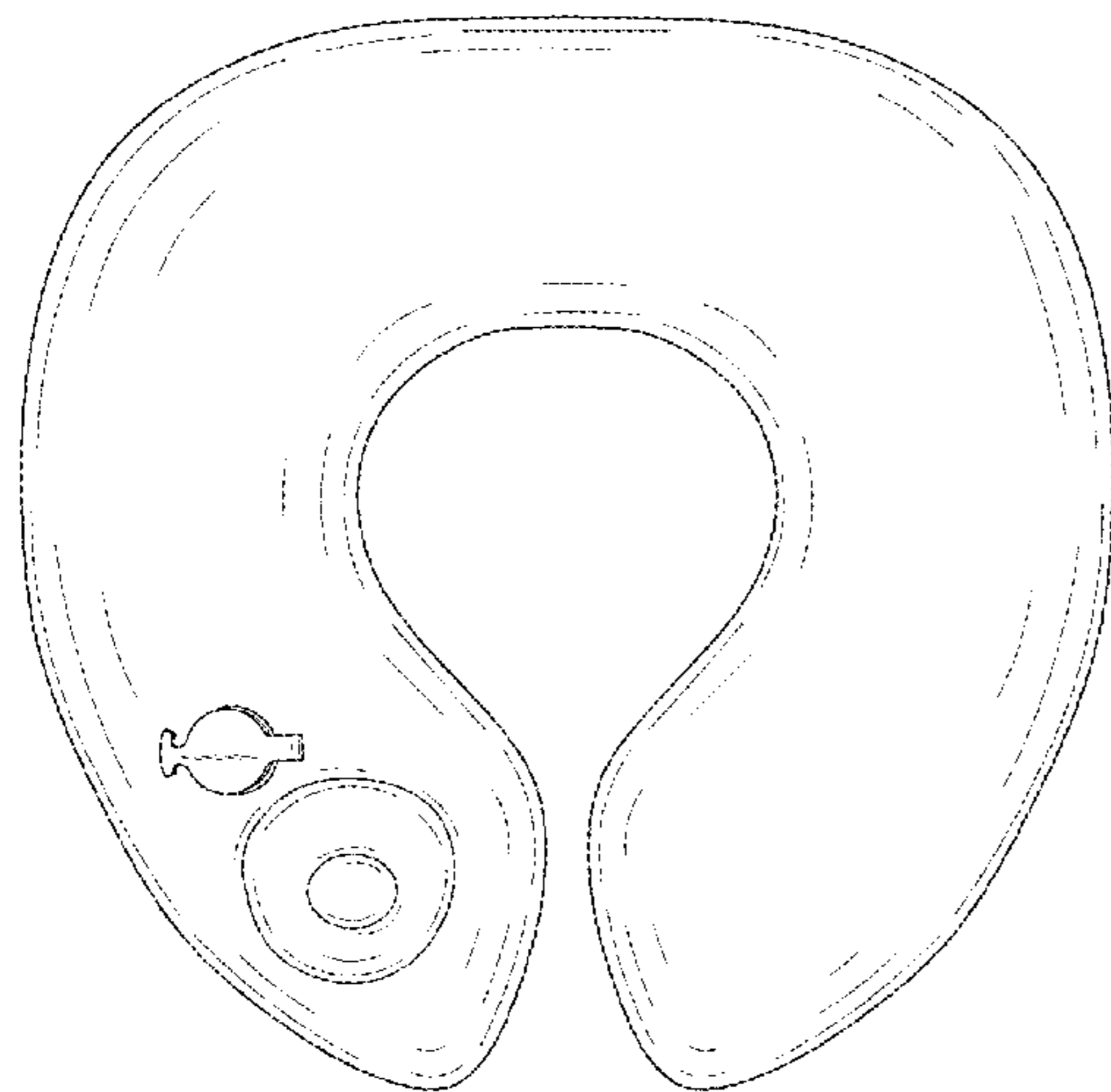

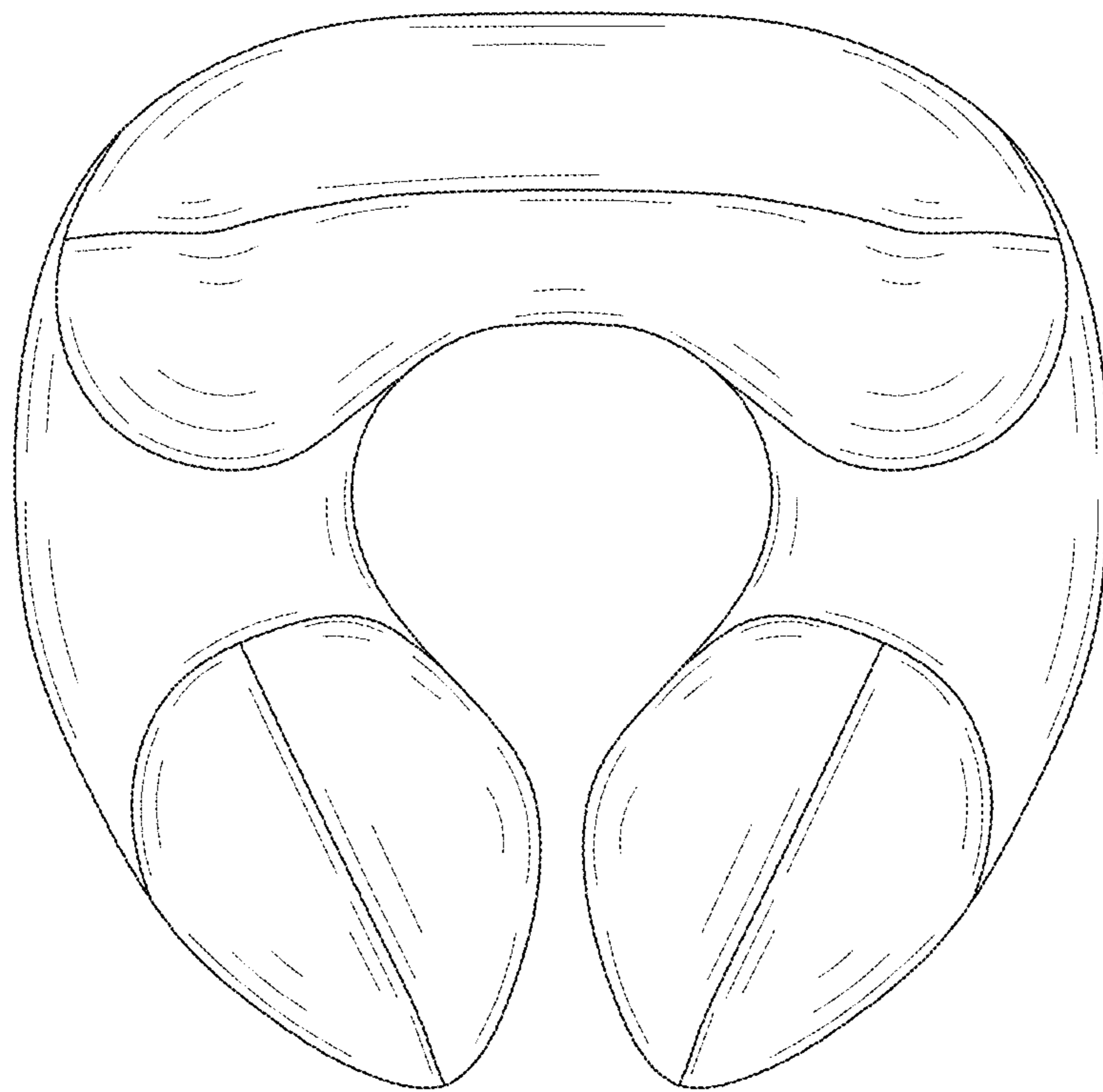

FIG.1

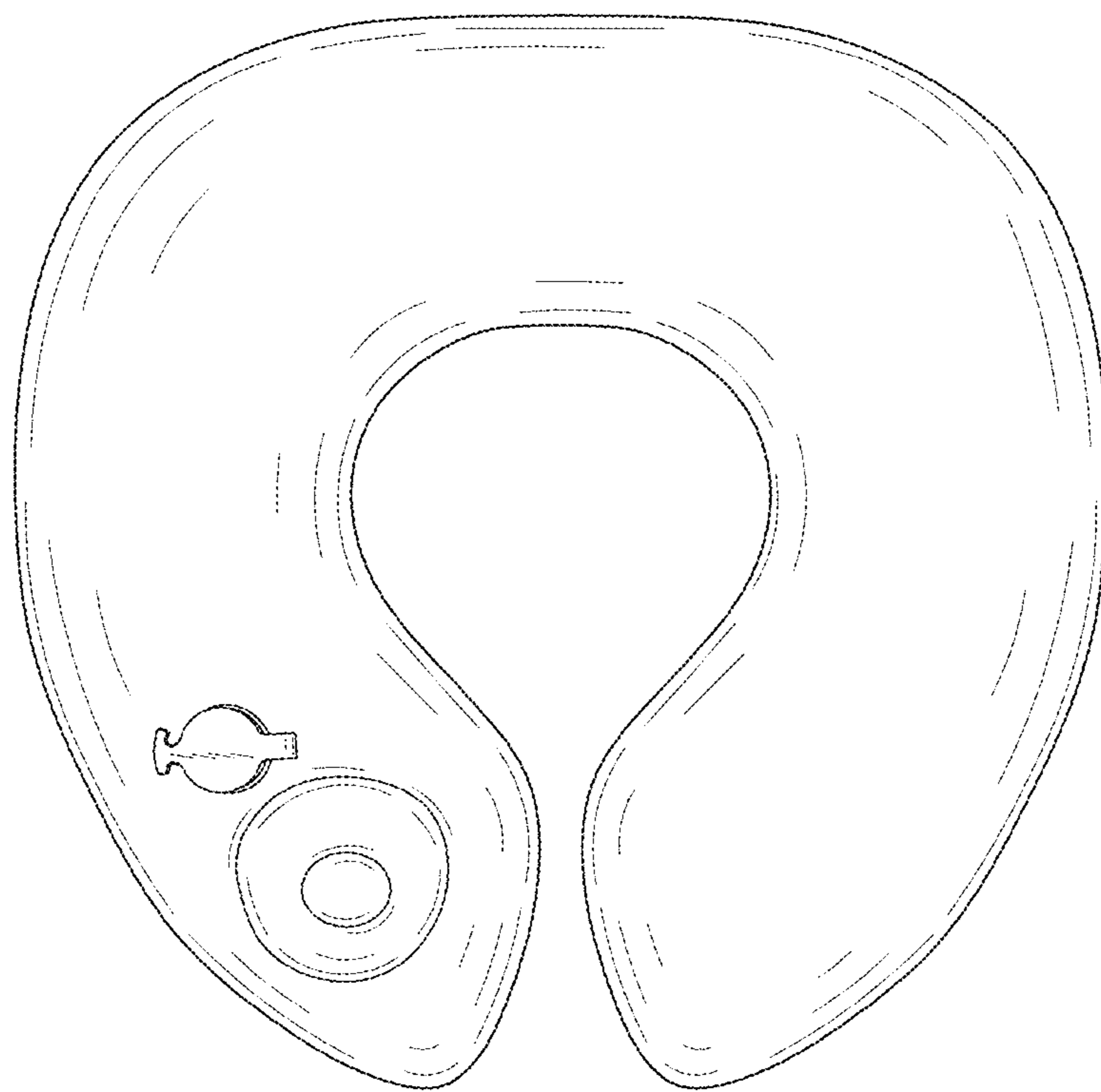

FIG.2

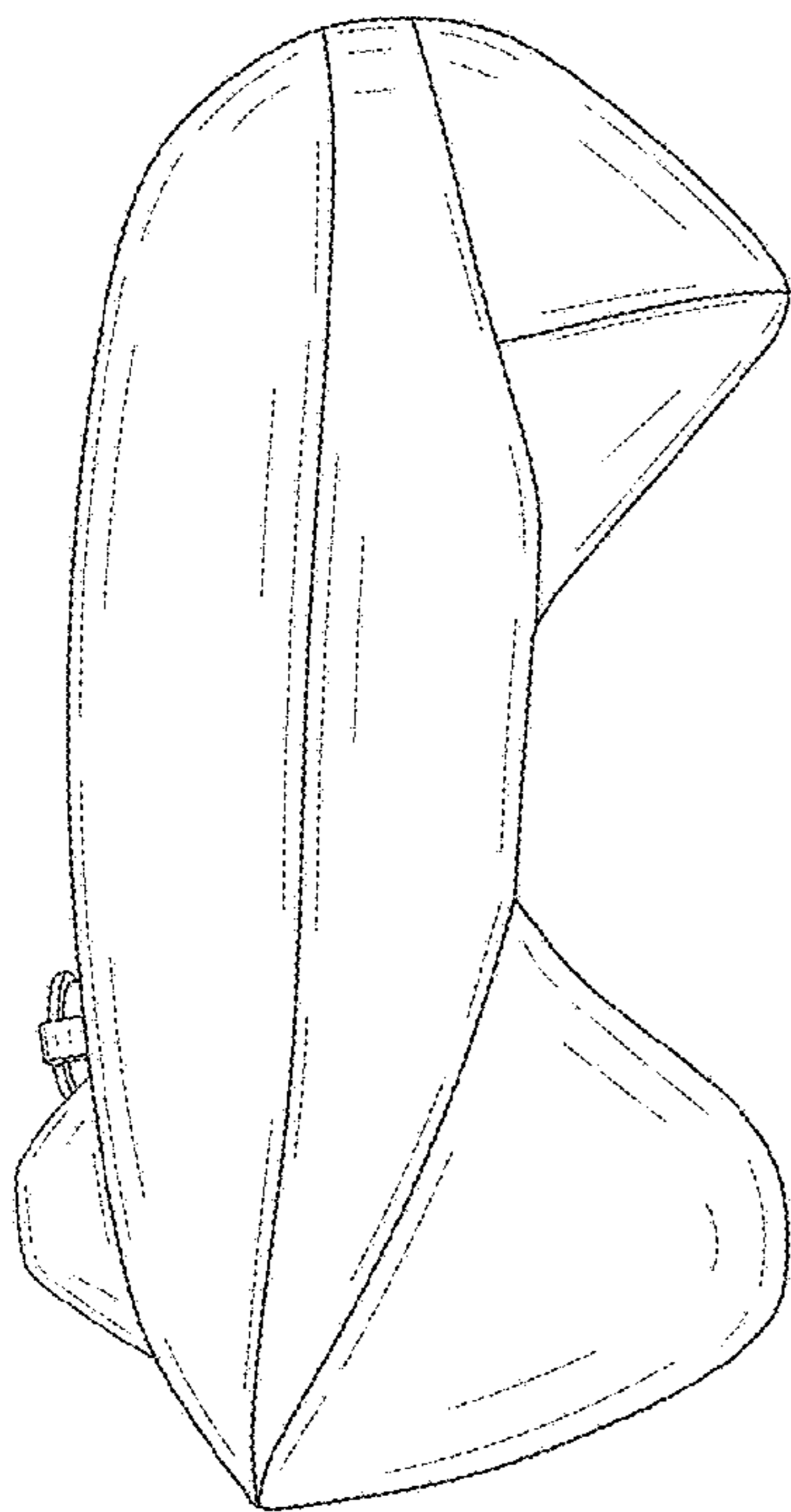

FIG.3

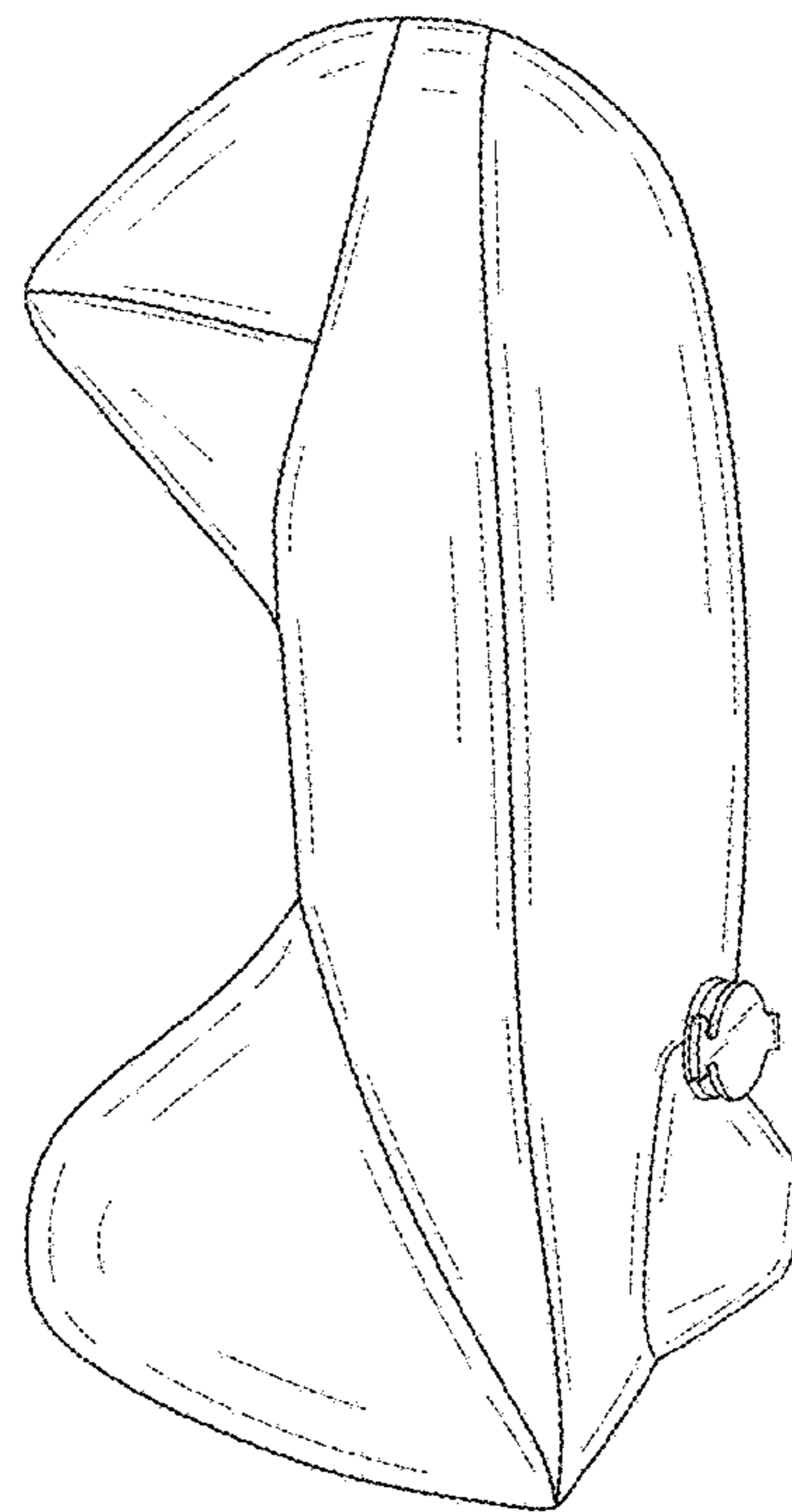

FIG.4

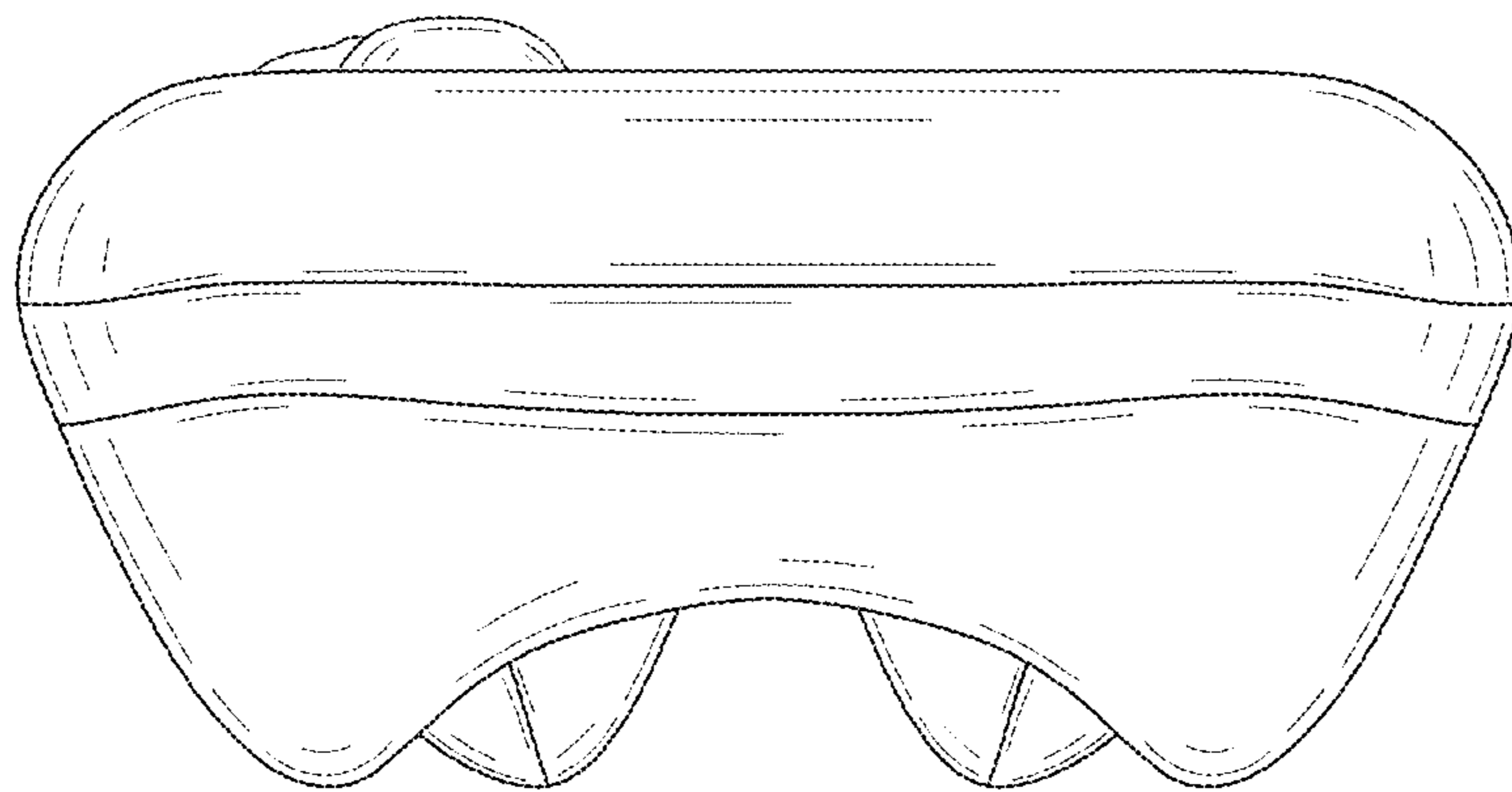

FIG. 5

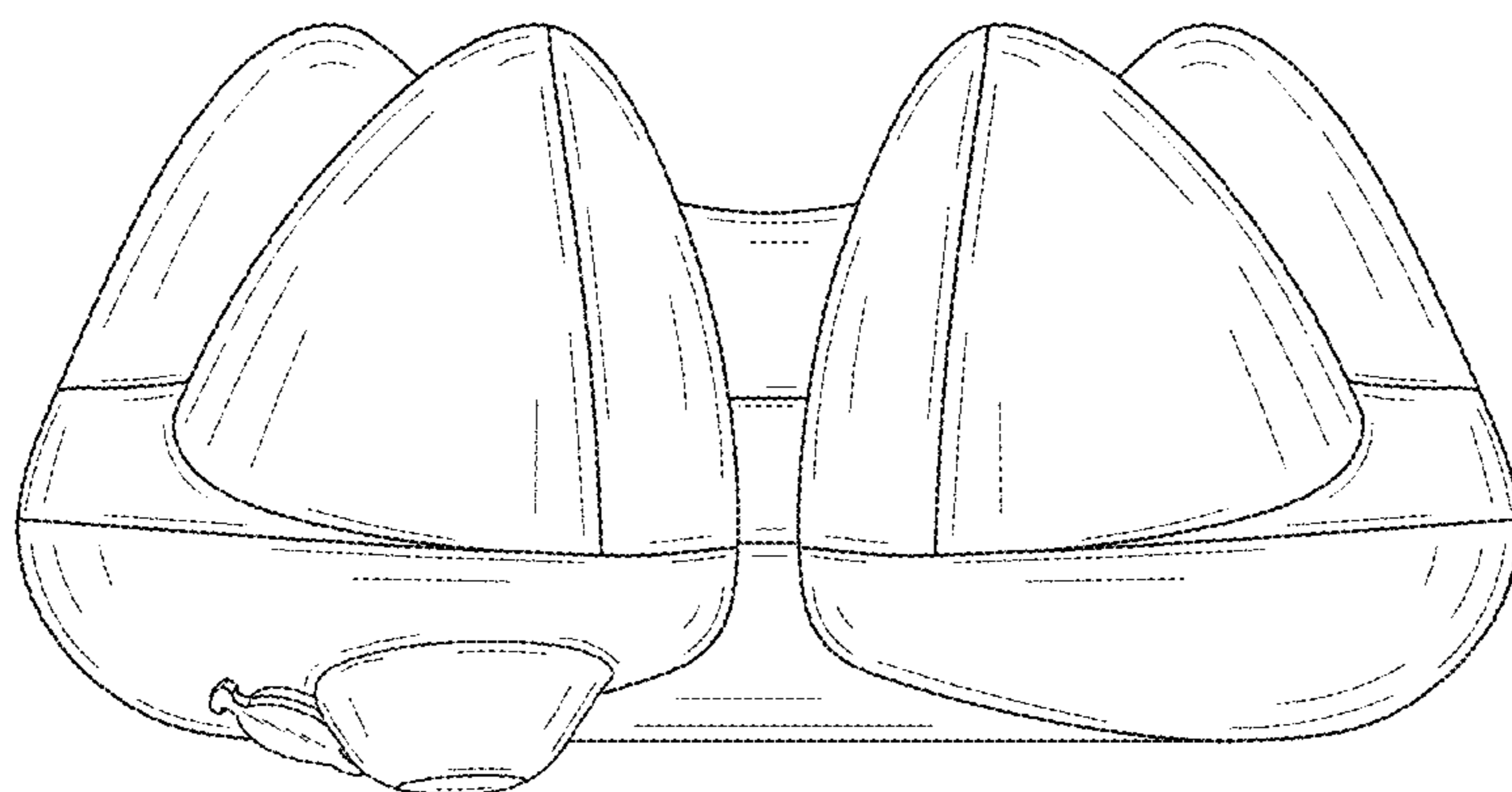

FIG. 6

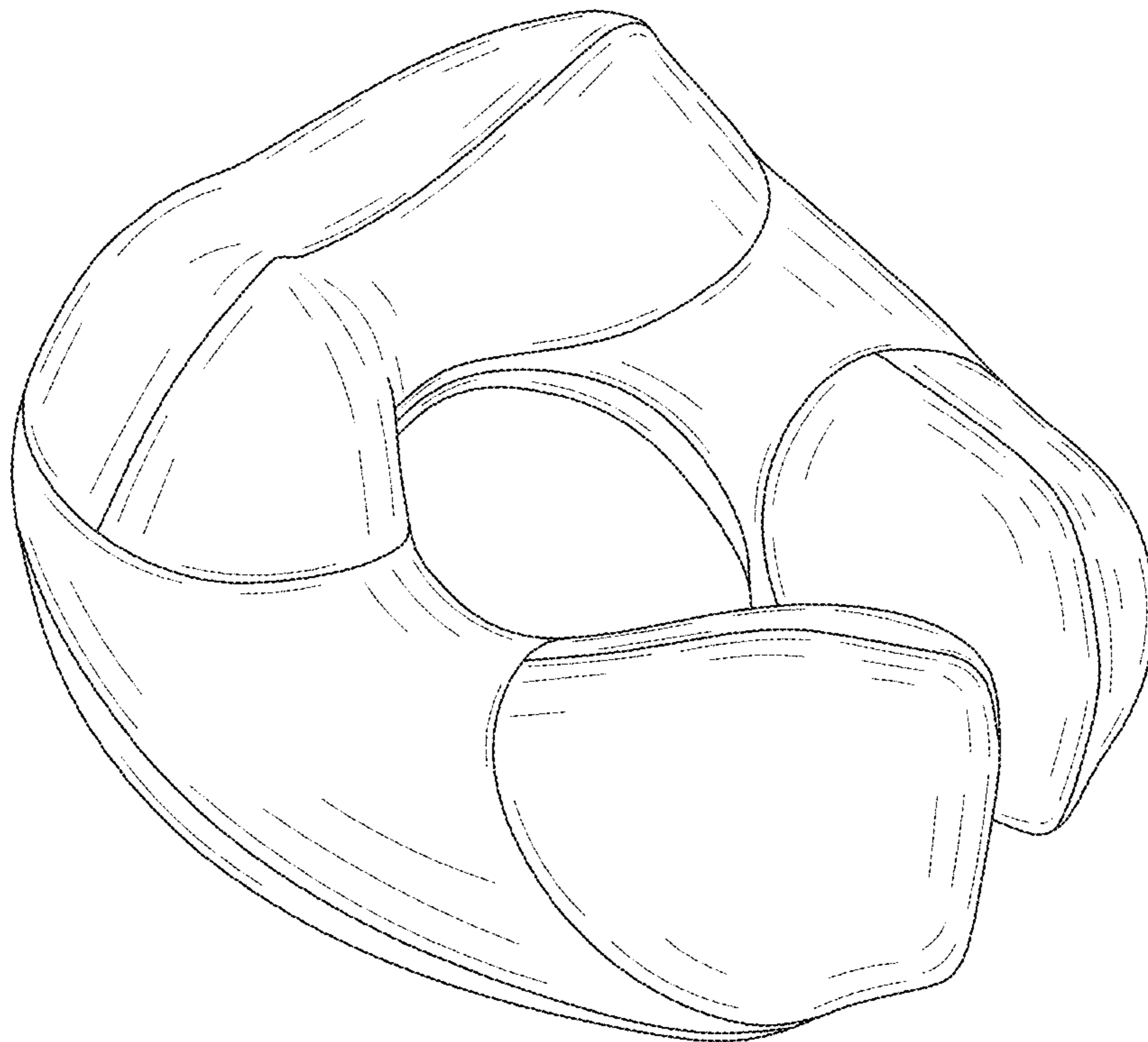

FIG.7

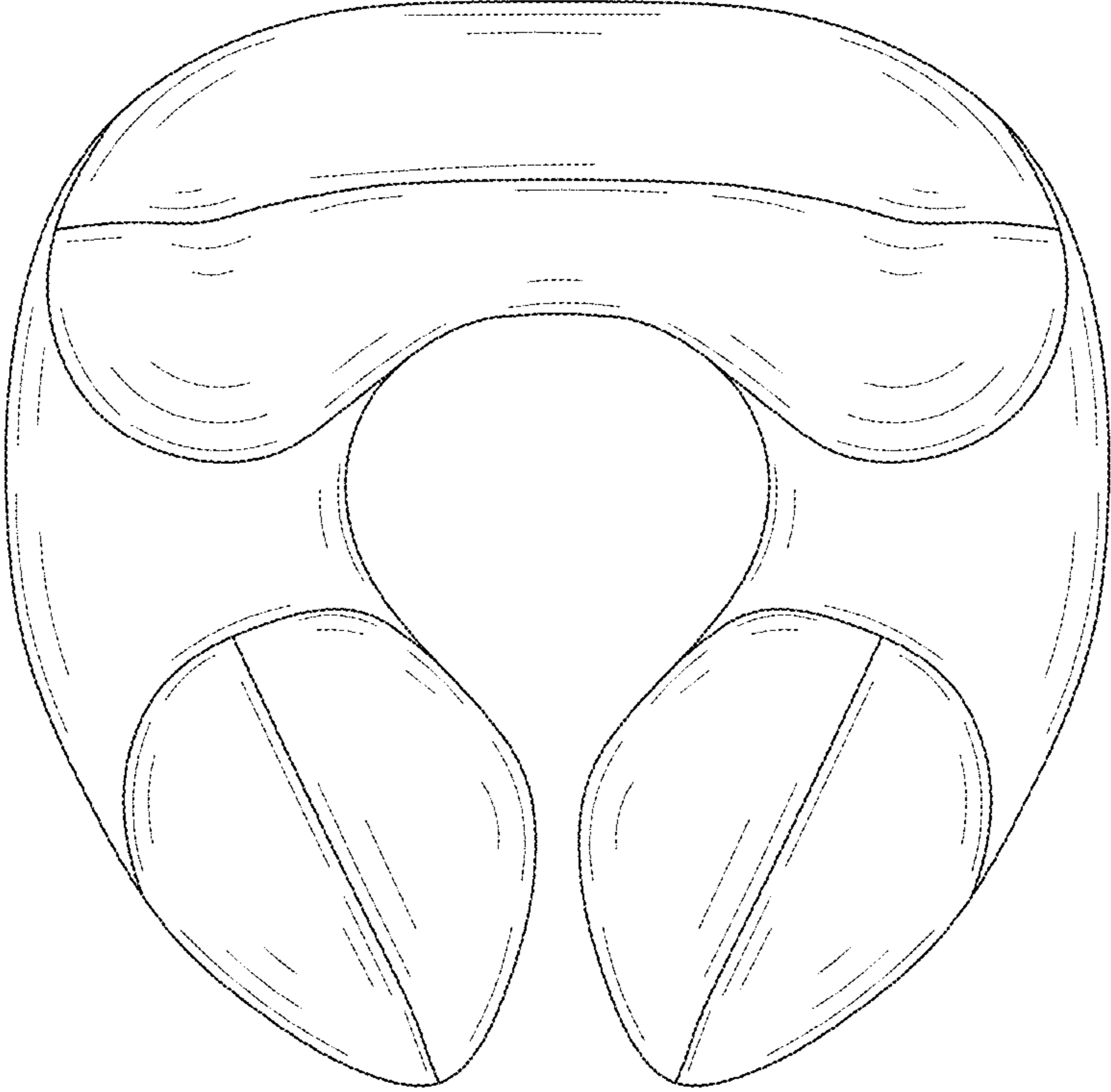

FIG. 8

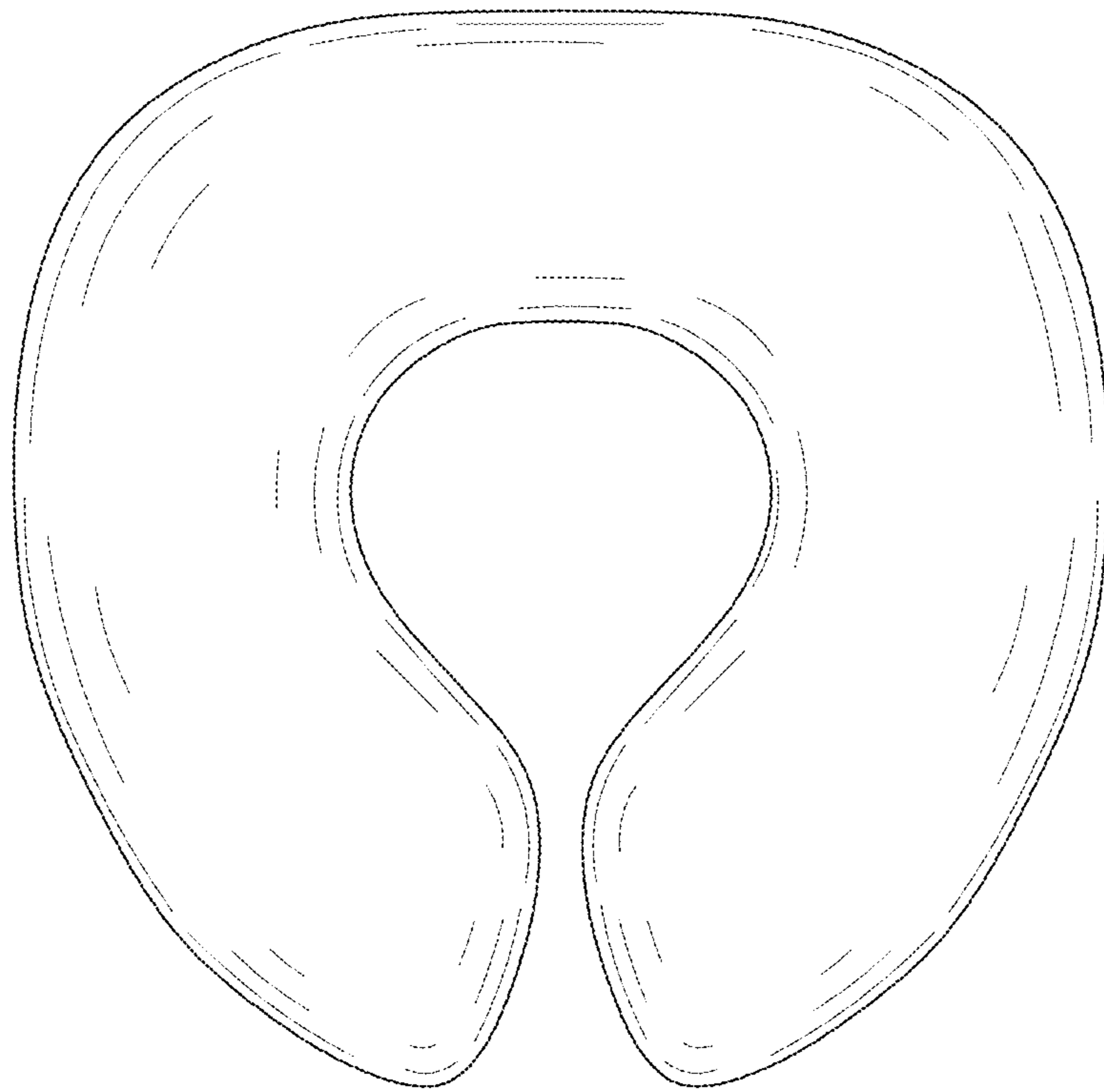

FIG.9

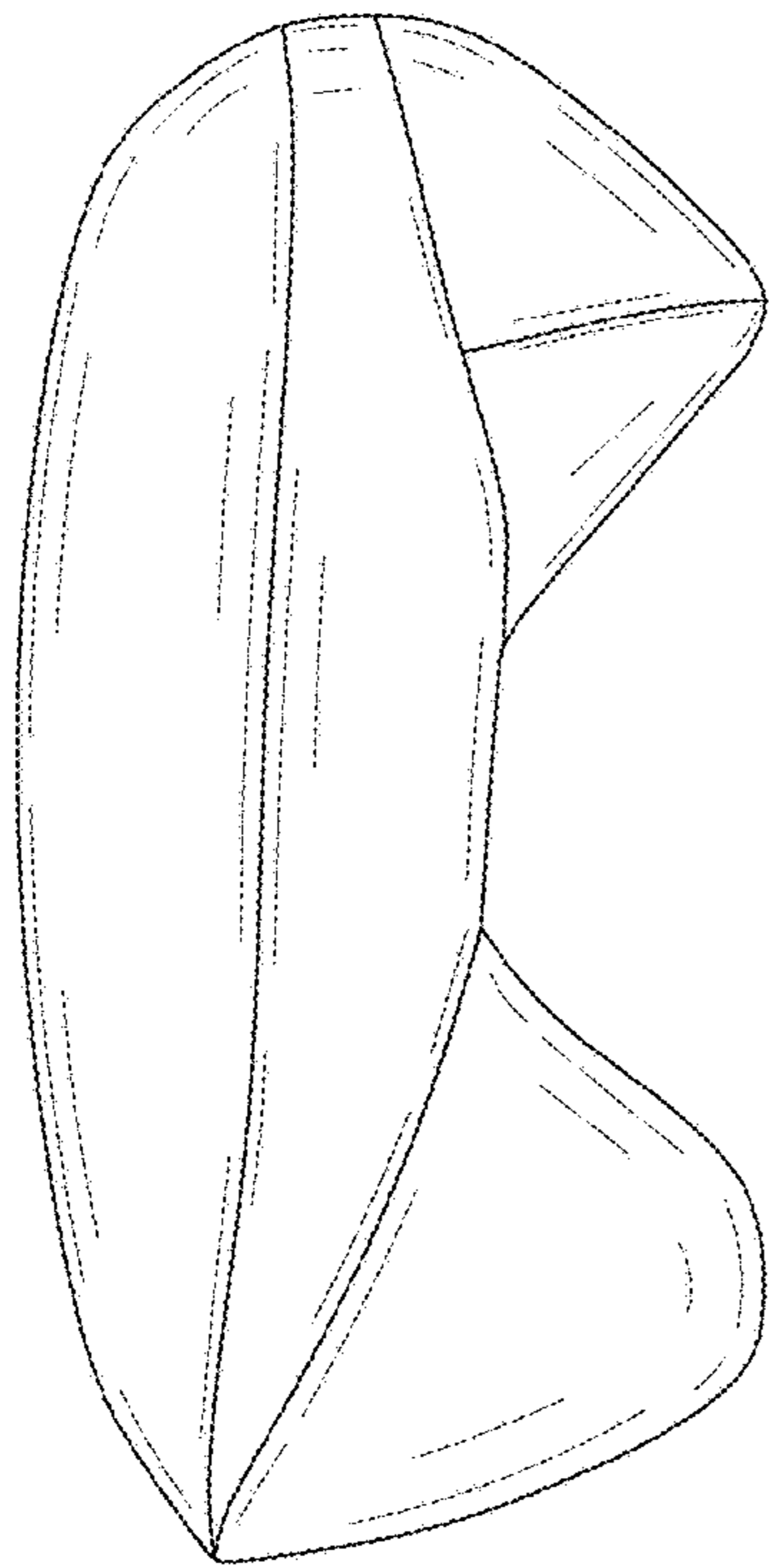

FIG.10

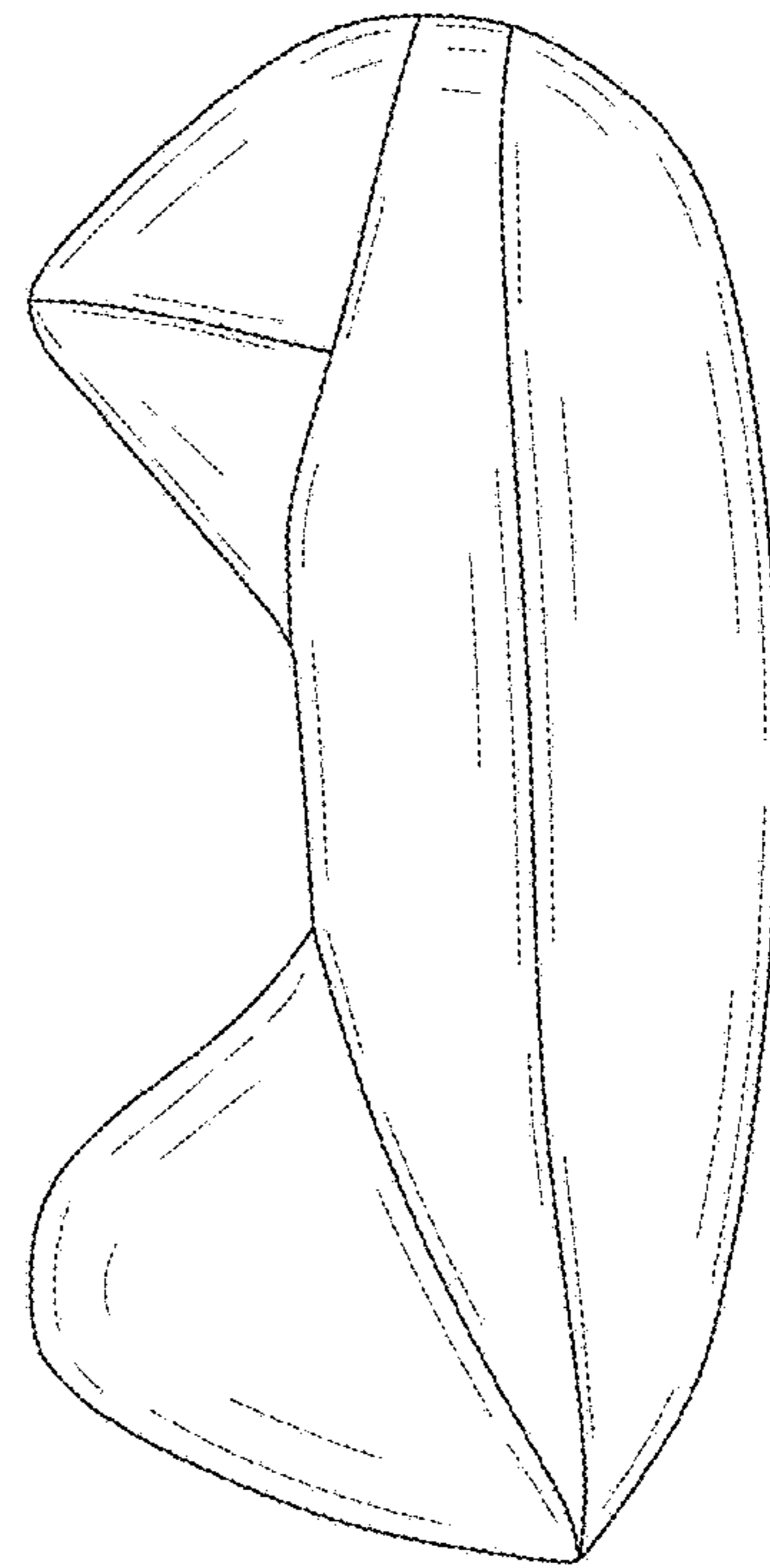

FIG.11

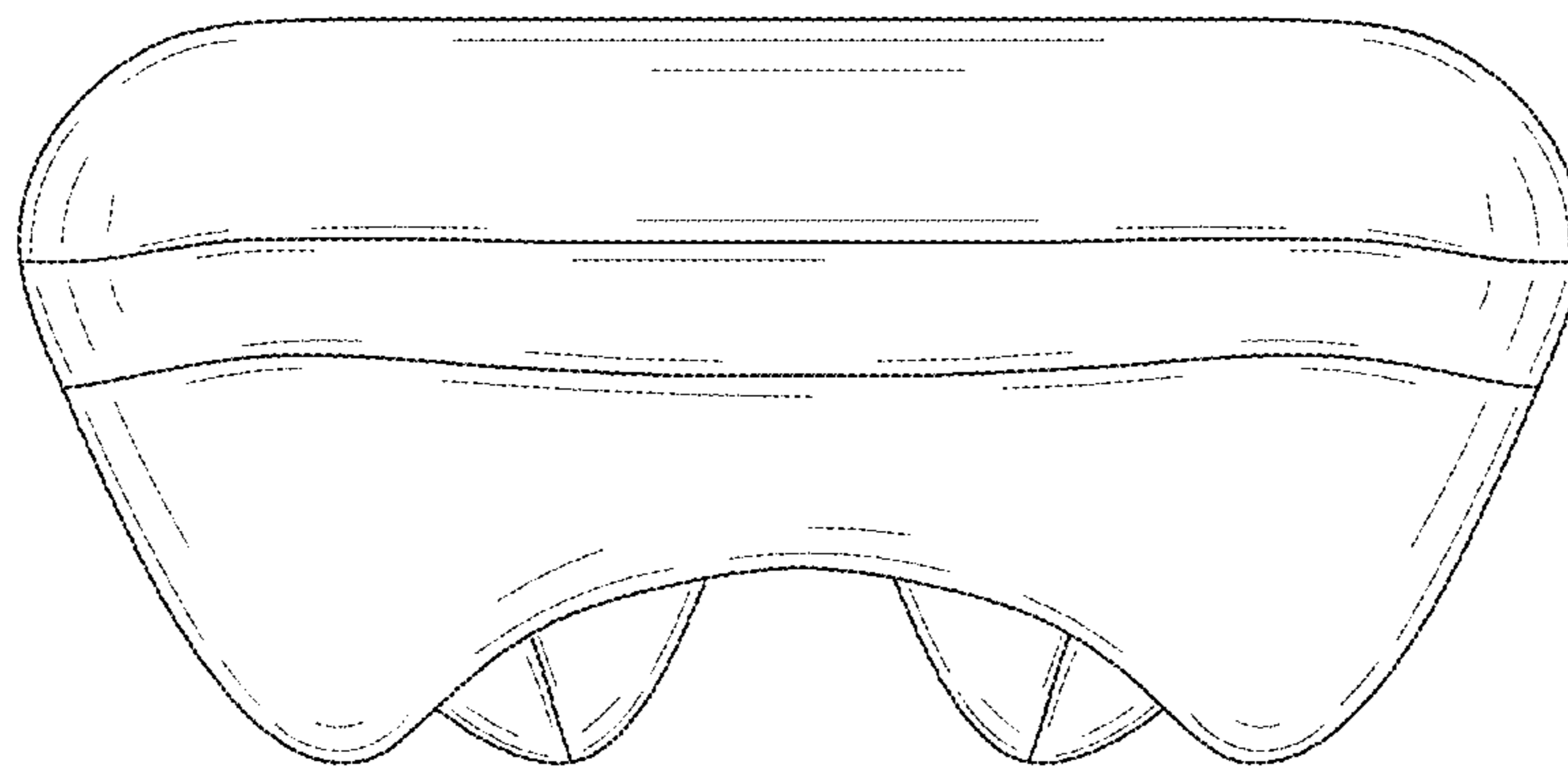

FIG.12

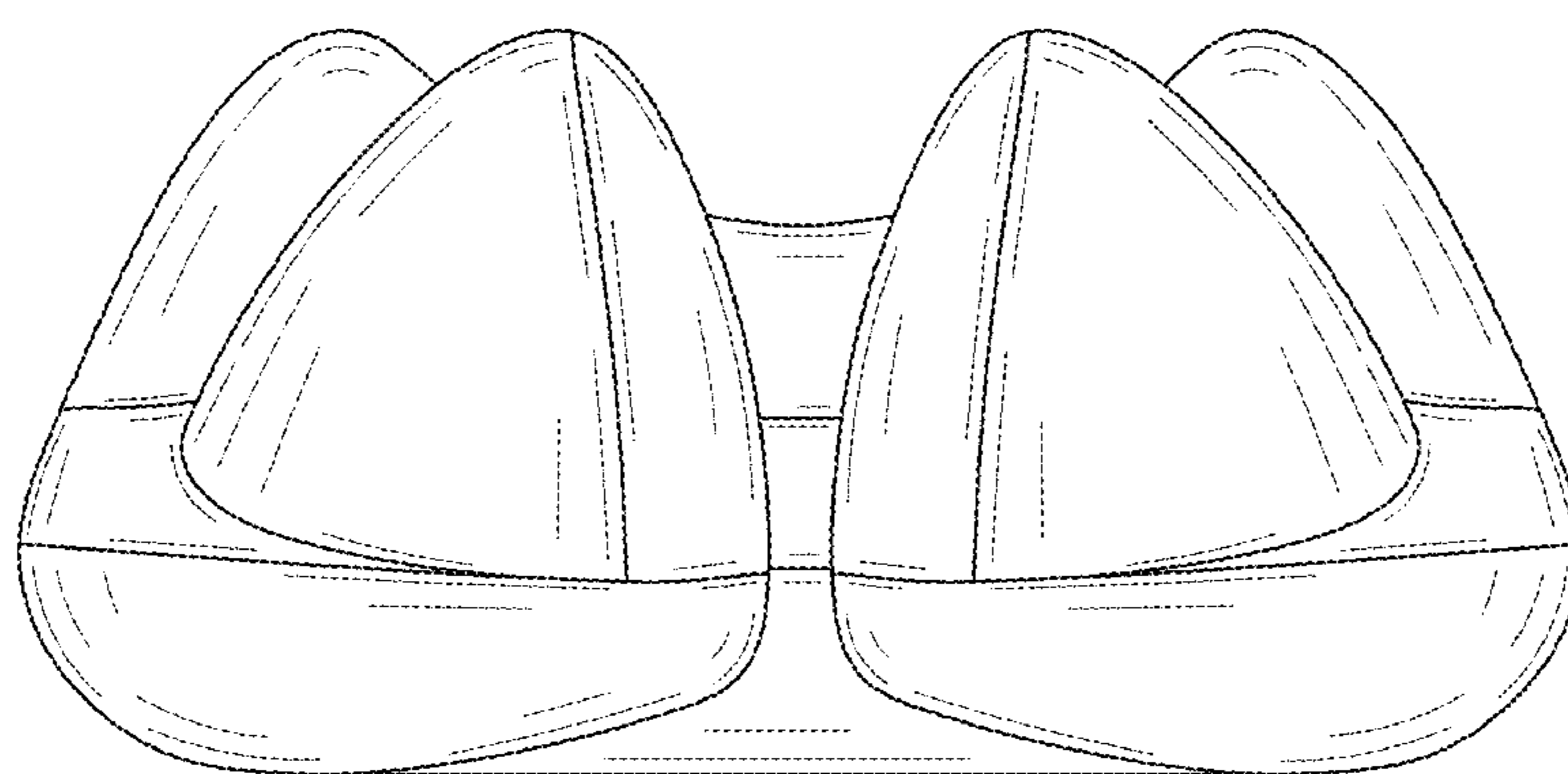

FIG.13

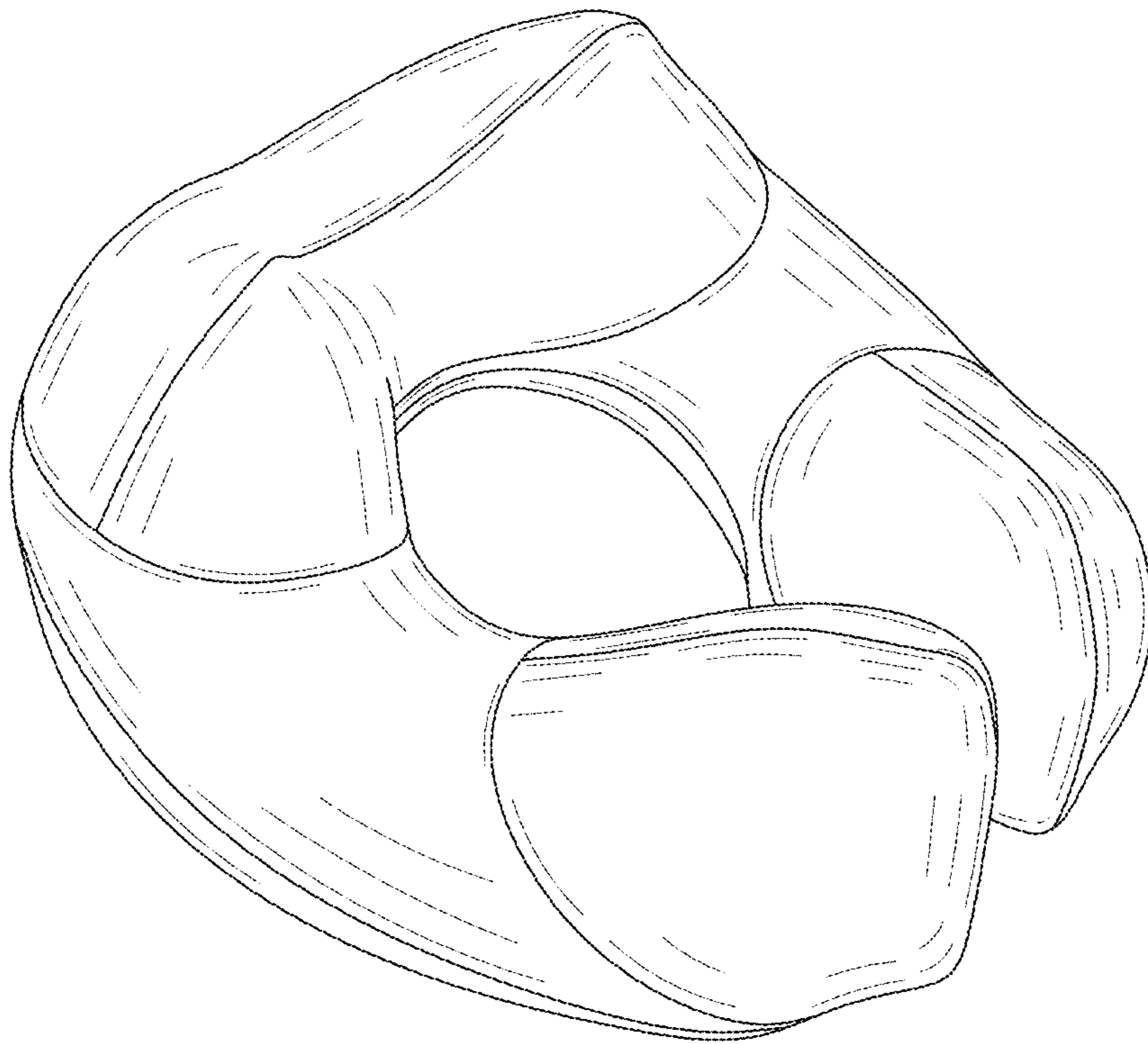

FIG.14