



US00D846839S

(12) **United States Design Patent**
Yim

(10) **Patent No.:** **US D846,839 S**

(45) **Date of Patent:** **** Apr. 30, 2019**

- (54) **HAT**
- (71) Applicant: **Hyo Jeong Yim**, Palisades Park, NJ
(US)
- (72) Inventor: **Hyo Jeong Yim**, Palisades Park, NJ
(US)
- (**) Term: **15 Years**
- (21) Appl. No.: **29/591,563**
- (22) Filed: **Jan. 20, 2017**
- (51) **LOC (11) Cl.** **02-03**
- (52) **U.S. Cl.**
USPC **D2/889**
- (58) **Field of Classification Search**
USPC D2/865, 866, 867, 869, 870, 873, 878,
D2/879, 883, 888, 889, 891, 895
CPC .. A42B 1/00; A42B 1/004; A42B 1/04; A42B
1/041; A42B 1/12; A42B 1/225; A42B
1/248
See application file for complete search history.

(56) **References Cited**

U.S. PATENT DOCUMENTS

- 167,538 A * 9/1875 Isidor et al. A42B 1/043
2/195.7
- D58,384 S * 7/1921 Jeffries D2/889
- D62,863 S * 8/1923 Strauss D2/889
- 1,616,475 A * 2/1927 Tracey A42B 1/04
2/171.01
- D131,419 S * 2/1942 Hogg D11/116
- D192,953 S * 5/1962 Zelony D2/865
- D273,436 S * 4/1984 Lipschutz D1/129
- D277,426 S * 2/1985 Eisinger D2/879
- D287,421 S * 12/1986 Scaggs D2/869
- D359,155 S * 6/1995 Loveless D2/889
- 5,509,145 A * 4/1996 Stevenson A42B 1/225
2/171.1
- D398,437 S * 9/1998 Sisolak D2/869

- D445,560 S * 7/2001 Nam D2/865
- D455,891 S * 4/2002 Biedrzycki D2/869
- D472,695 S * 4/2003 Lee D2/889
- D482,186 S * 11/2003 Pytanowski D2/889
- 6,711,749 B2 * 3/2004 White A42B 1/225
2/195.8
- D589,687 S * 4/2009 Hoepfner D2/878
- D590,136 S * 4/2009 Campos D2/882
- D595,033 S * 6/2009 Lynn D2/882
- D678,616 S * 3/2013 Norton D29/102
- D770,146 S * 11/2016 Yates D2/889
- 2009/0199323 A1 * 8/2009 Zakarian A42B 1/225
2/209.14
- 2017/0188644 A1 * 7/2017 Foresta A42B 1/041

* cited by examiner

Primary Examiner — Karen S Acker
Assistant Examiner — Jasmine Mlinarcik

(57) **CLAIM**

The ornamental design for a hat, as shown and described.

DESCRIPTION

FIG. 1 is a front perspective view with an opening at the apex of the design;
 FIG. 2 is a front view of the design;
 FIG. 3 is a left side view of the design;
 FIG. 4 is a right side view of the design;
 FIG. 5 is a back side view of the design;
 FIG. 6 is a top side view with an opening at the center of the design;
 FIG. 7 is a bottom side view with an opening at the center of the design; and,
 FIG. 8 is a rear perspective view.
 The broken lines illustrating the elements of a pattern along the brim depict features of the hat that form no part of the claimed design. The broken line depiction of the partial human figure in FIG. 8 shows the hat in a position of used and forms no part of the claimed design.

1 Claim, 8 Drawing Sheets

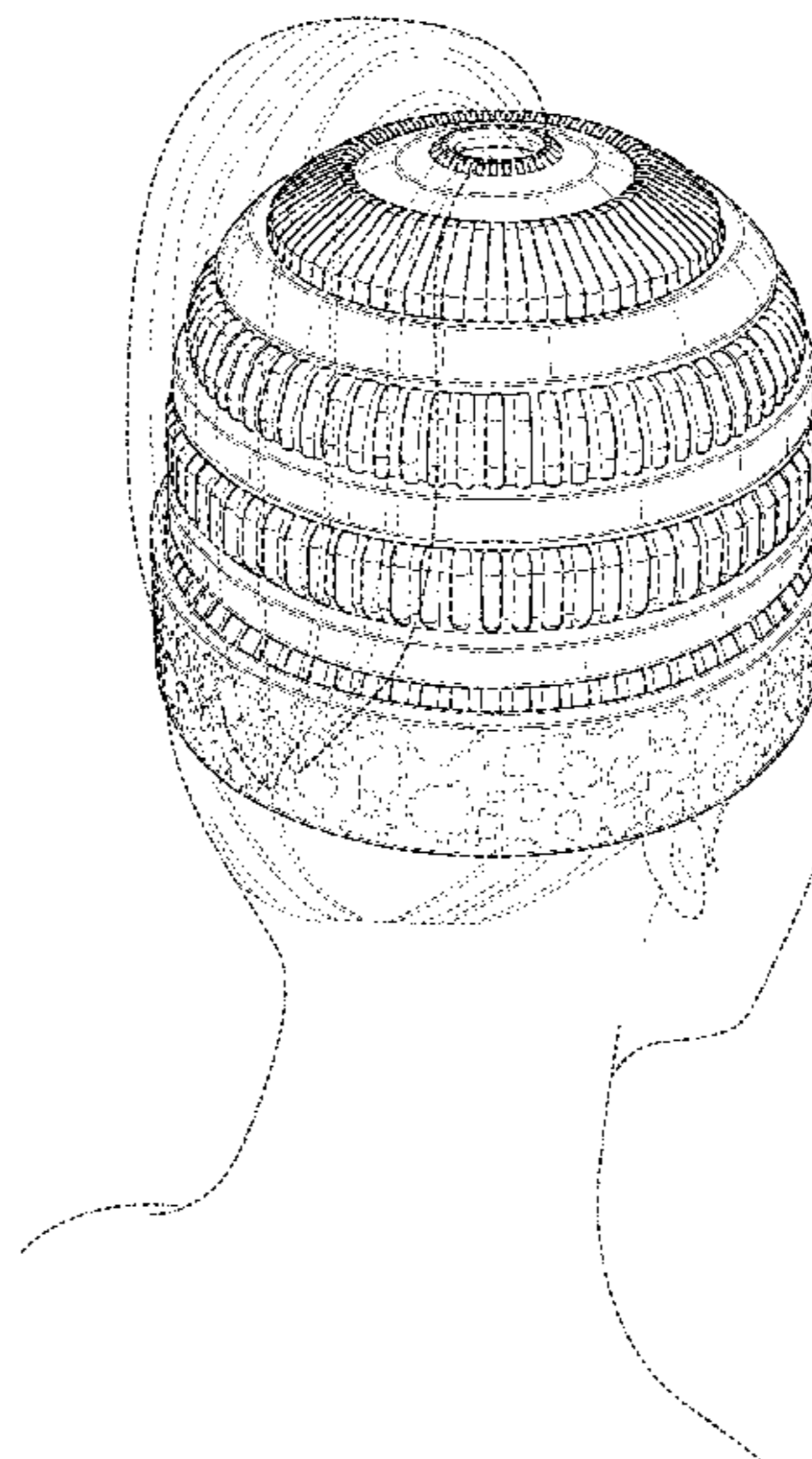
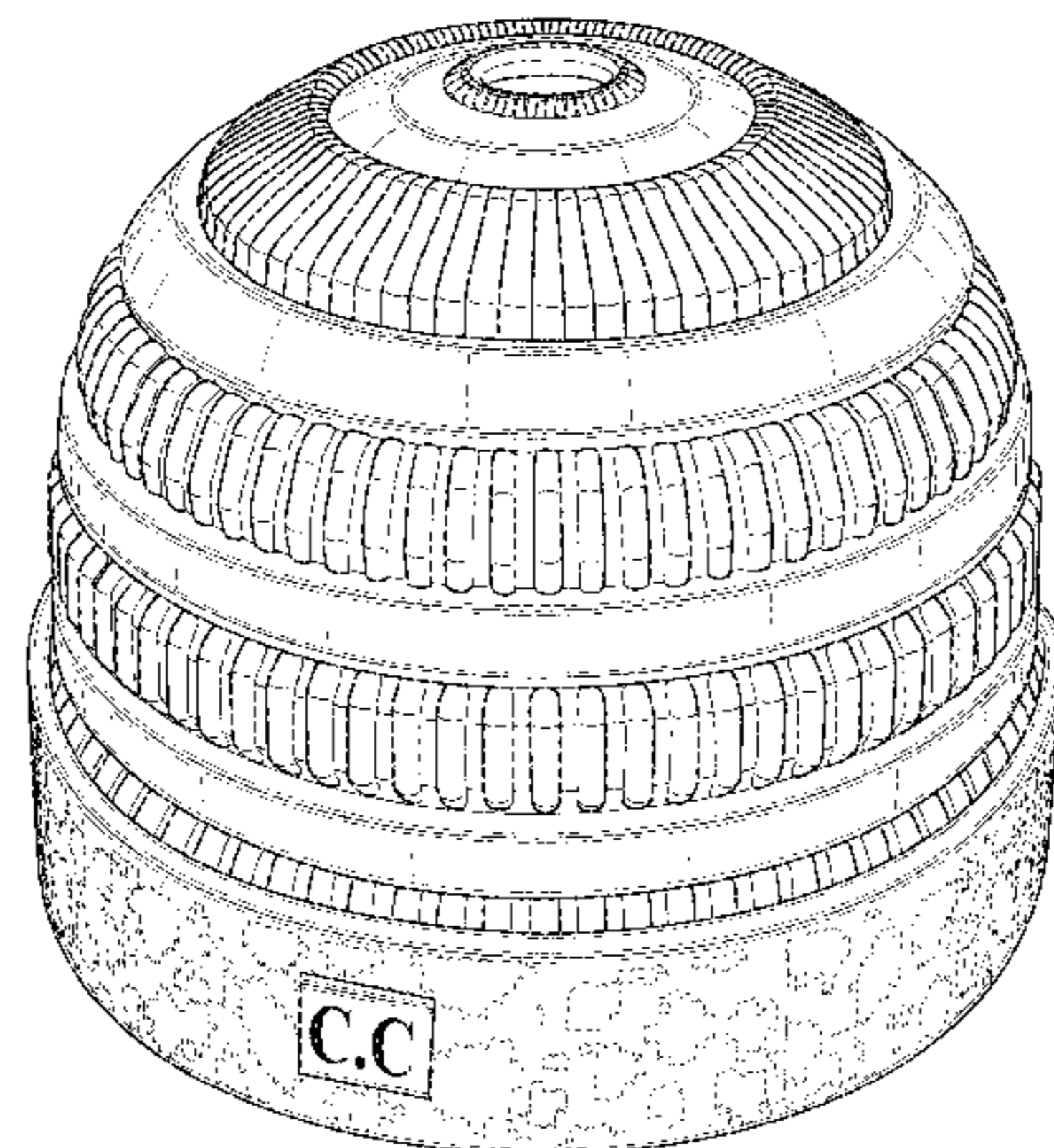

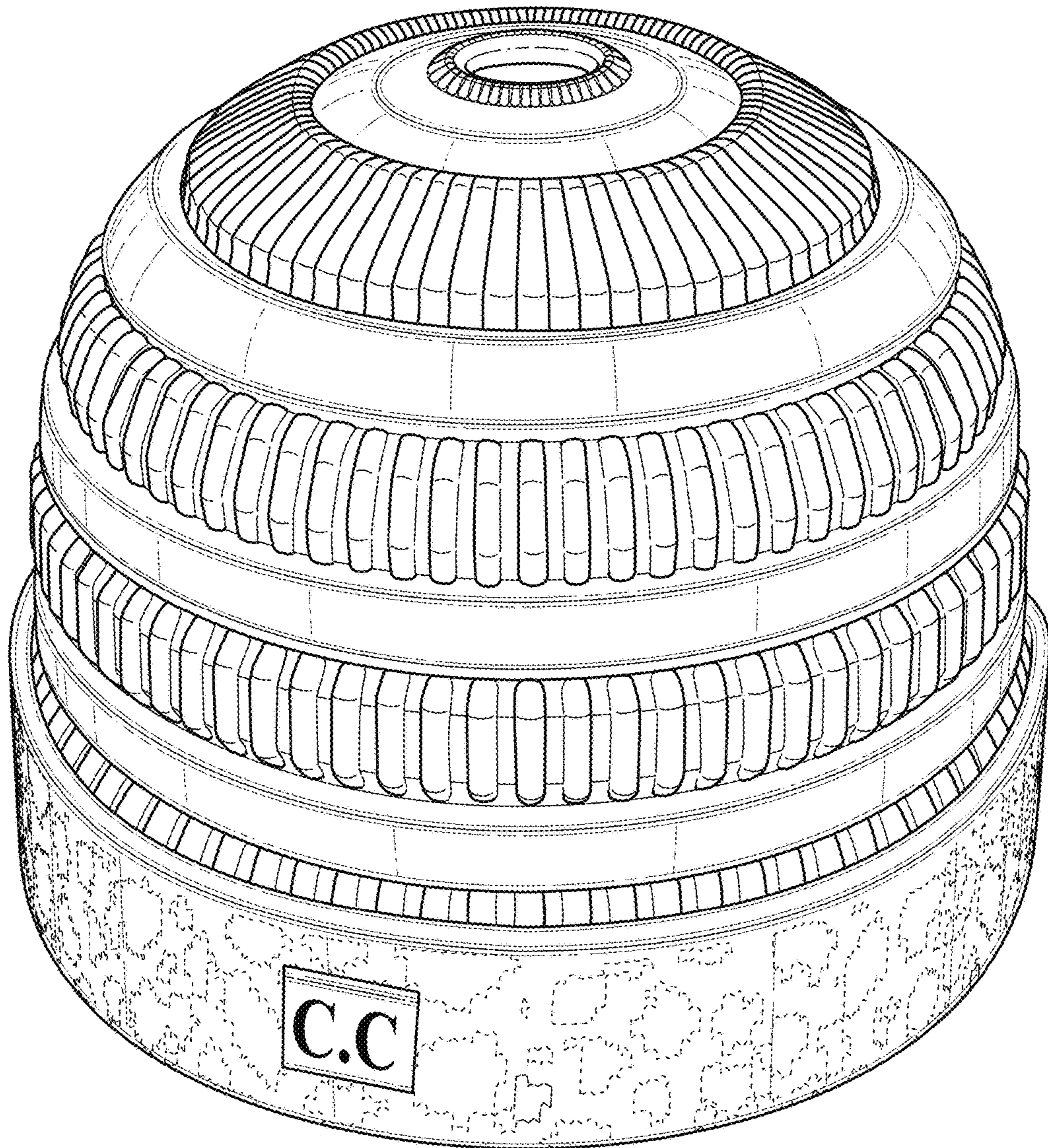

FIG. 1

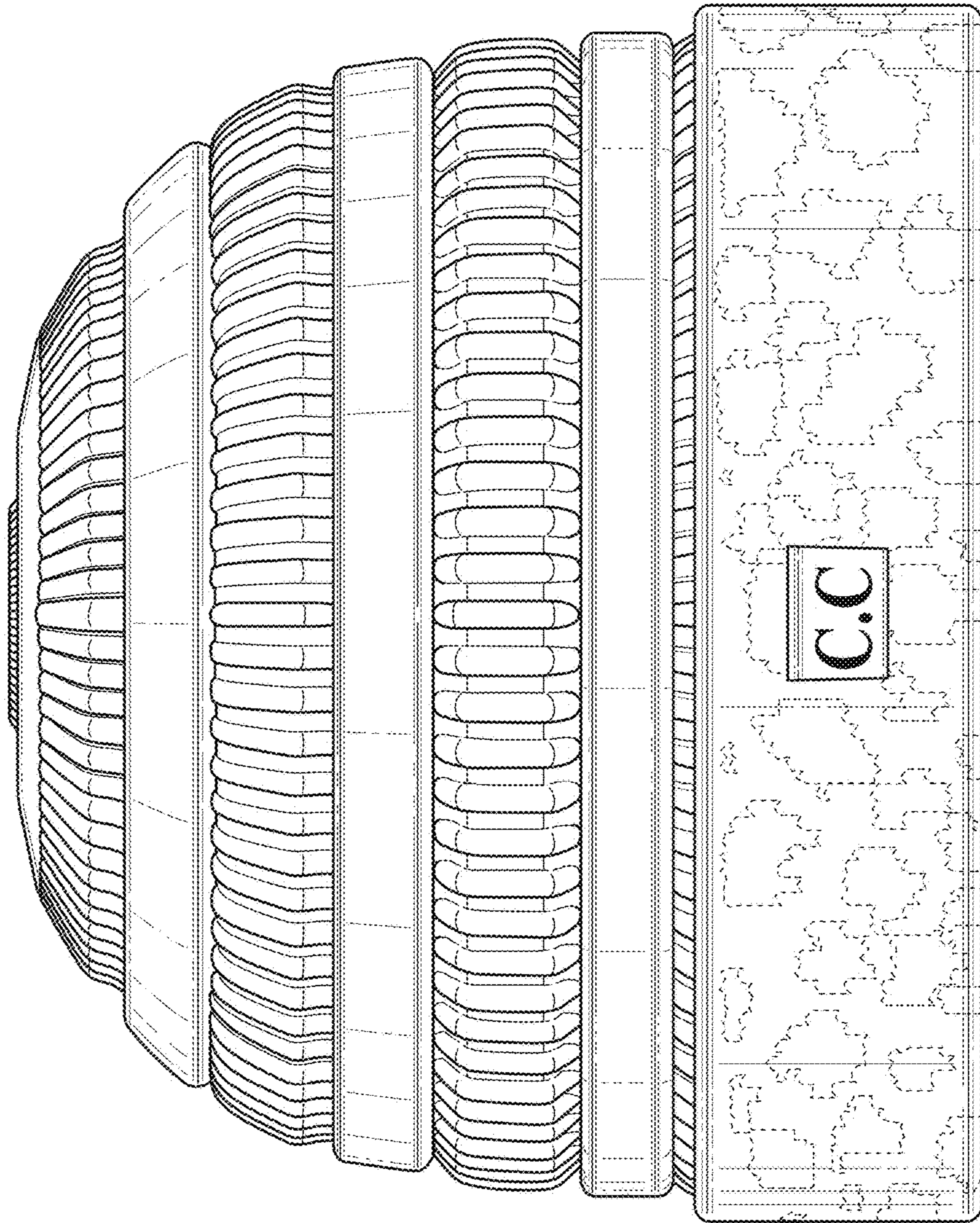

FIG. 2

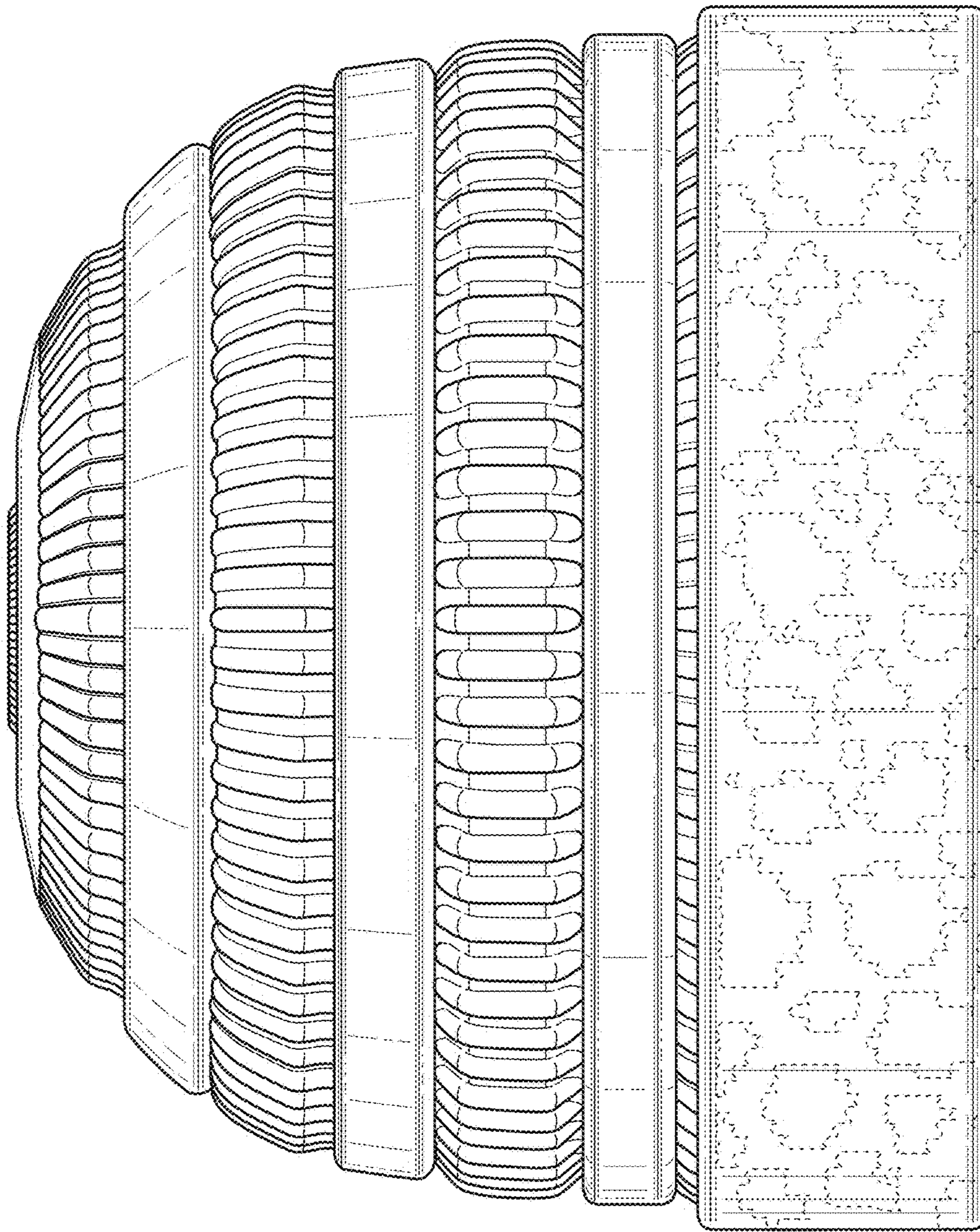

FIG. 3

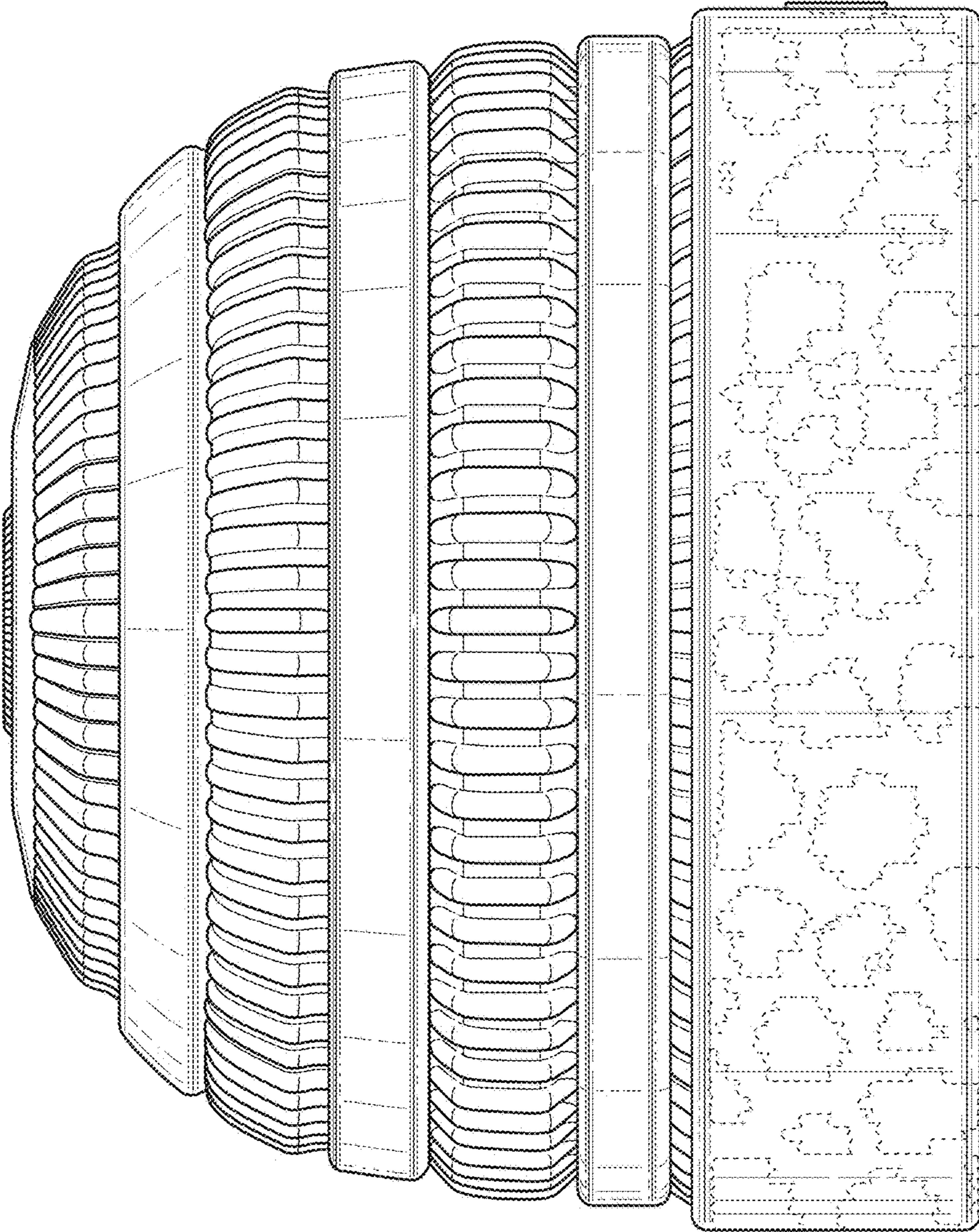

FIG. 5

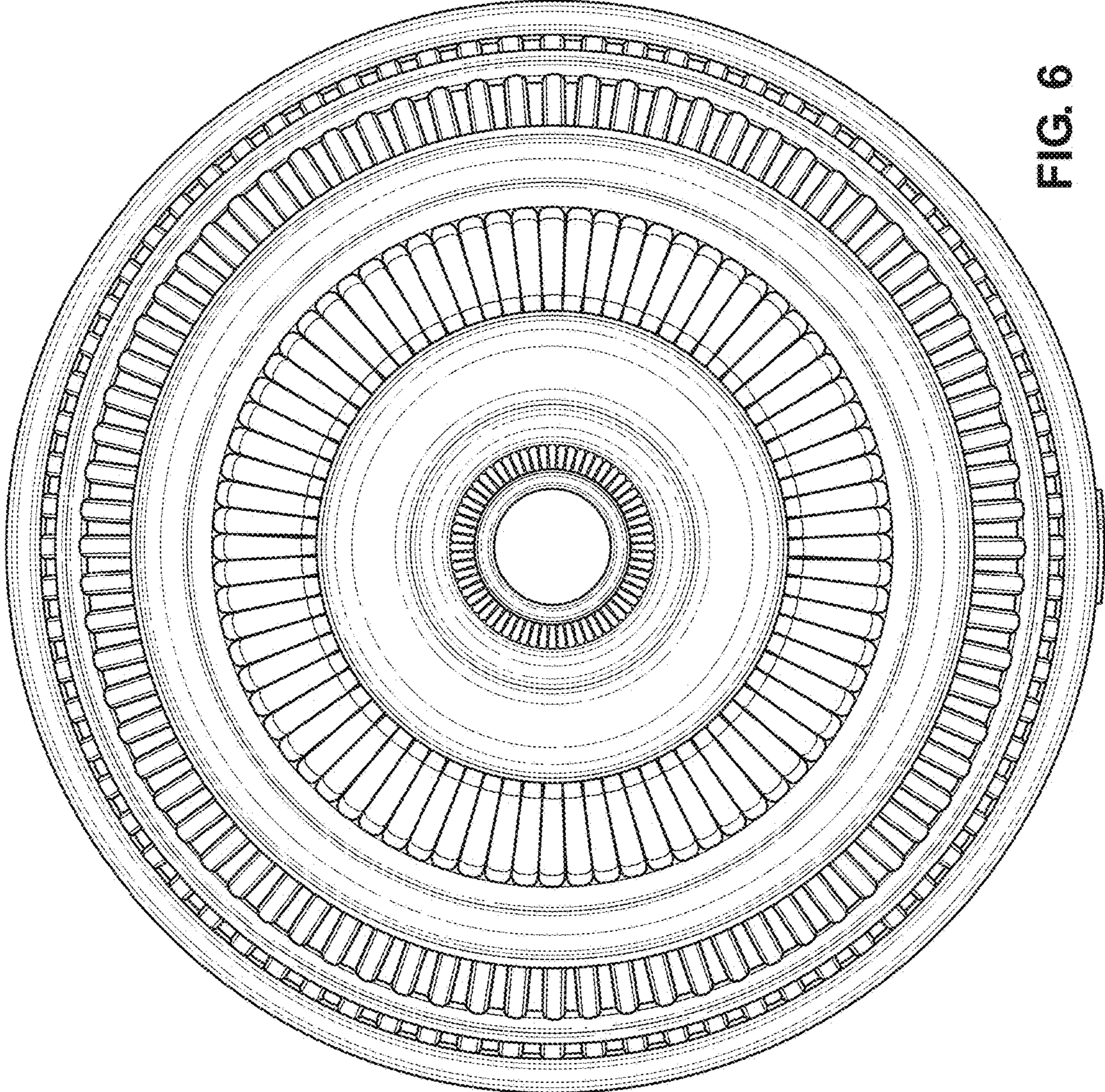

FIG. 6

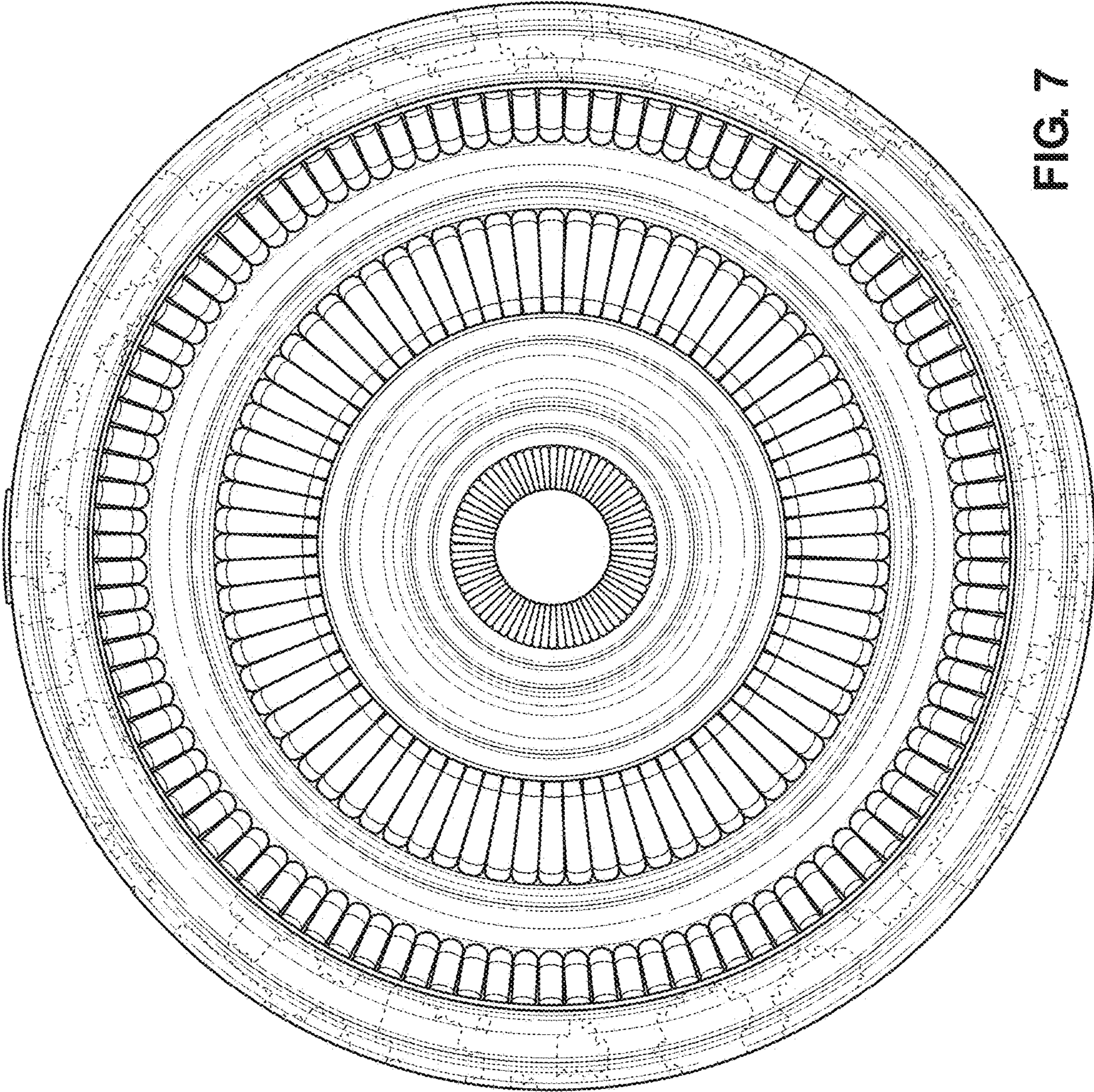

FIG. 7

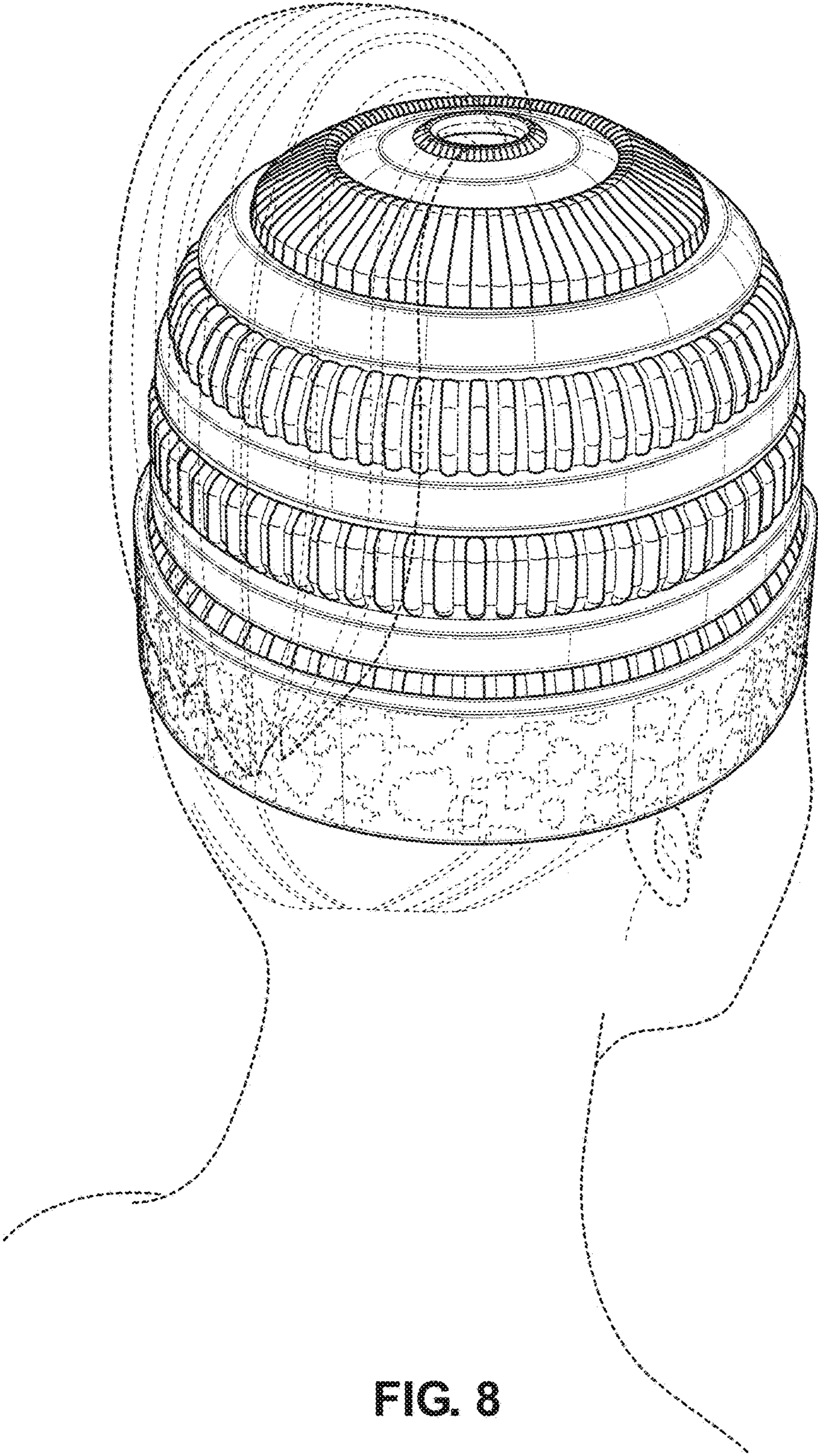

FIG. 8