



US00D846792S

(12) **United States Design Patent**  
**Wu**

(10) **Patent No.:** **US D846,792 S**

(45) **Date of Patent:** **\*\* Apr. 23, 2019**

(54) **VEHICLE LIGHT PART**

(71) Applicant: **COPLUS INC.**, Tainan (TW)

(72) Inventor: **Po-Hua Wu**, Tainan (TW)

(73) Assignee: **Coplus Inc.**, Tainan (TW)

(\*\*) Term: **15 Years**

(21) Appl. No.: **29/584,170**

(22) Filed: **Nov. 11, 2016**

(30) **Foreign Application Priority Data**

May 13, 2016 (TW) ..... 105302654

(51) **LOC (11) Cl.** ..... **26-99**

(52) **U.S. Cl.**  
USPC ..... **D26/139**

(58) **Field of Classification Search**  
USPC ..... D26/139, 28-36  
CPC ..... F21S 48/10; F21S 48/225; F21S 48/1233;  
F21S 48/2268; F21S 48/00; F21S 48/115;  
F21S 48/1388; F21S 48/1266; F21V  
21/04  
See application file for complete search history.

(56) **References Cited**

**U.S. PATENT DOCUMENTS**

D425,240 S \* 5/2000 Goeckeritz ..... D26/139  
D676,599 S \* 2/2013 Davidson ..... D26/139

D696,454 S \* 12/2013 Conway ..... D26/139  
D709,645 S \* 7/2014 Hovind ..... D26/139  
D721,201 S \* 1/2015 Egly ..... D26/139  
D730,563 S \* 5/2015 Renshaw ..... D26/89  
D805,245 S \* 12/2017 Johns ..... D26/139  
D821,638 S \* 6/2018 Wu ..... D26/139  
D831,883 S \* 10/2018 Goltche ..... D26/139

\* cited by examiner

*Primary Examiner* — Katrina A Betton

(74) *Attorney, Agent, or Firm* — Lewis Roca Rothgerber  
Christie LLP

(57) **CLAIM**

The ornamental design for a vehicle light part, as shown and described.

**DESCRIPTION**

FIG. 1 is a front perspective view of the vehicle light part;  
FIG. 2 is a rear perspective view thereof;  
FIG. 3 is a front view thereof;  
FIG. 4 is a rear view thereof;  
FIG. 5 is a left side view thereof;  
FIG. 6 is a right side view thereof;  
FIG. 7 is a top view thereof; and,  
FIG. 8 is a bottom view thereof.

The broken lines in the drawings are for illustrative purpose only and form no part of the claimed design.

**1 Claim, 5 Drawing Sheets**

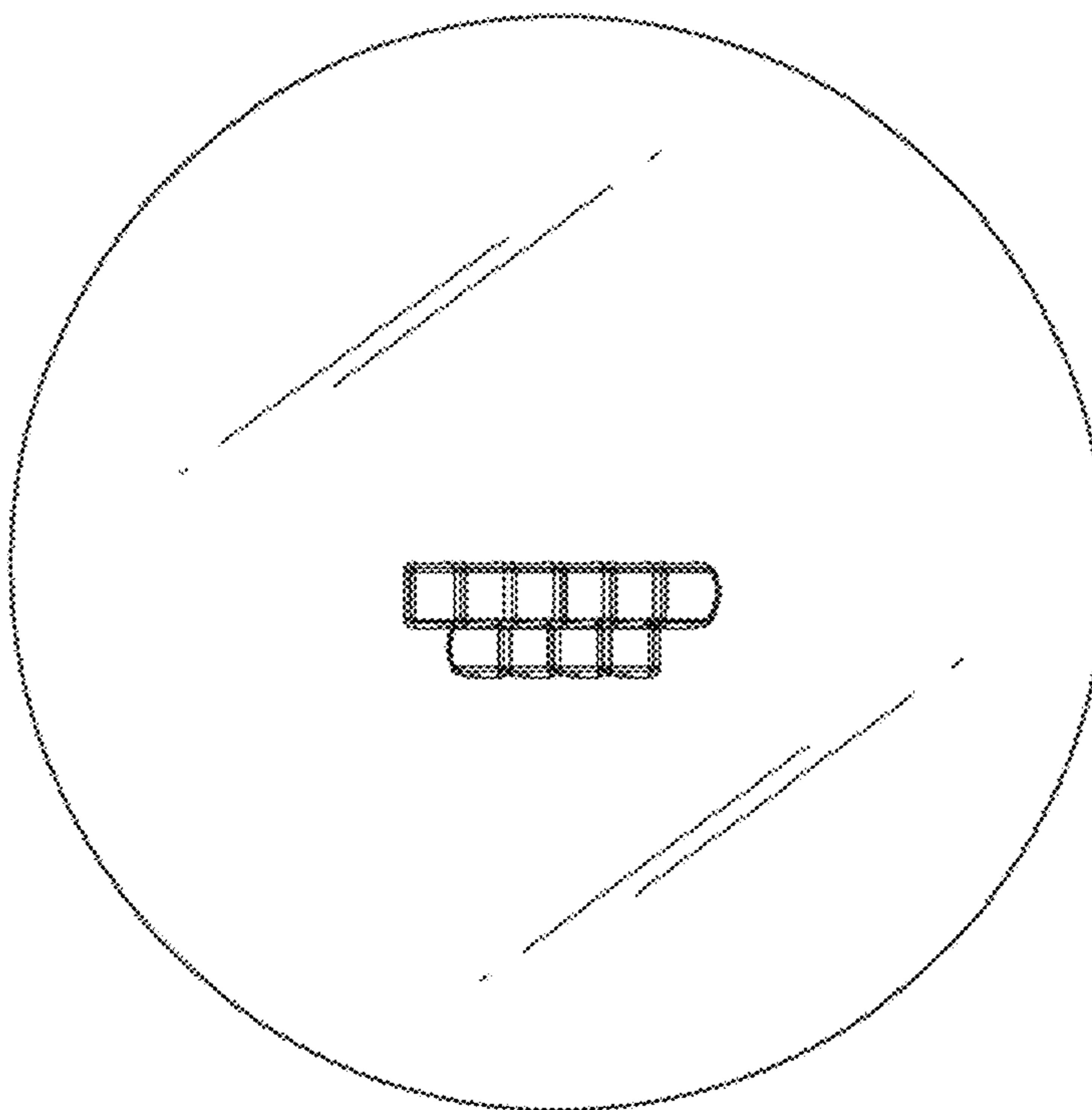

FIG. 1

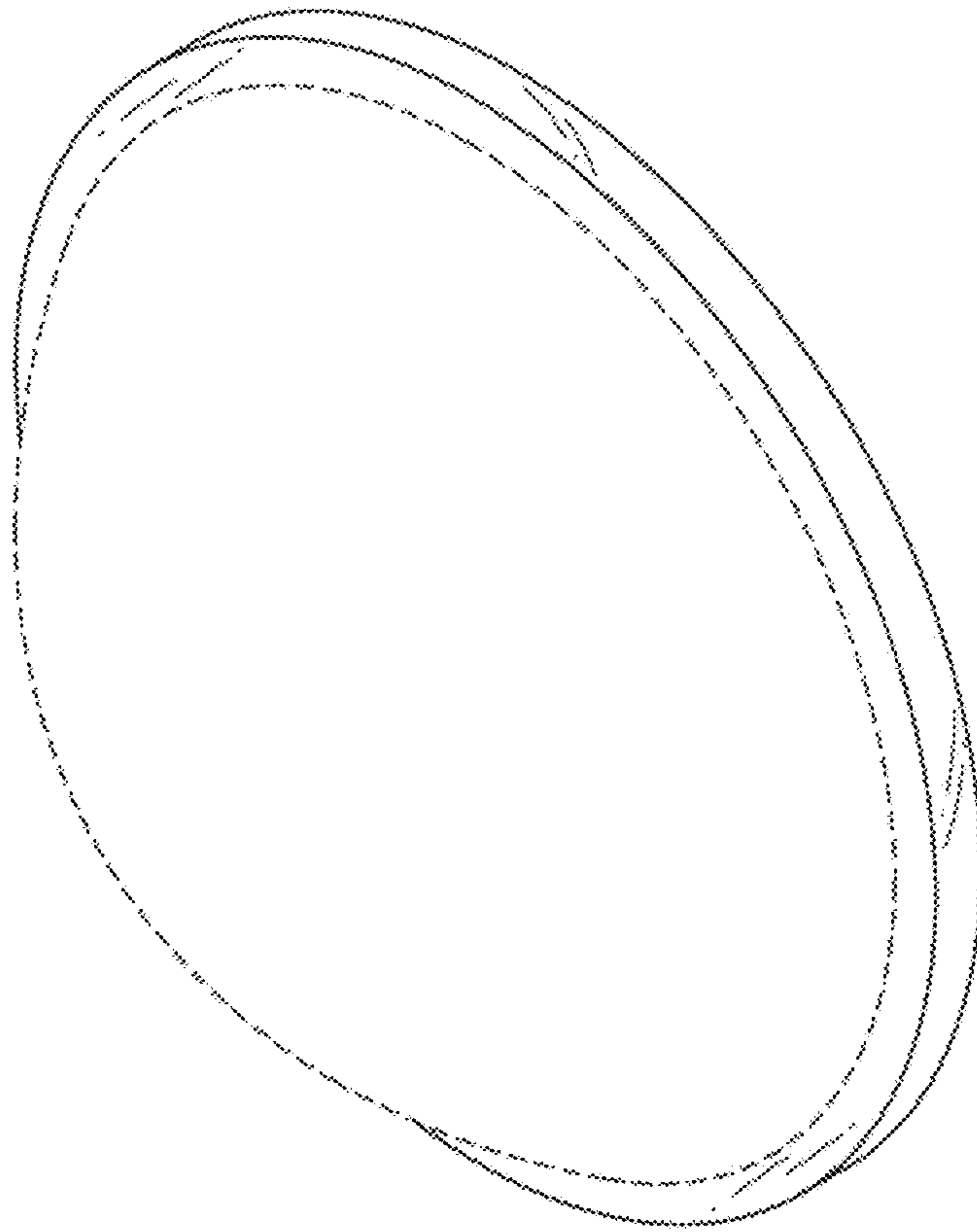
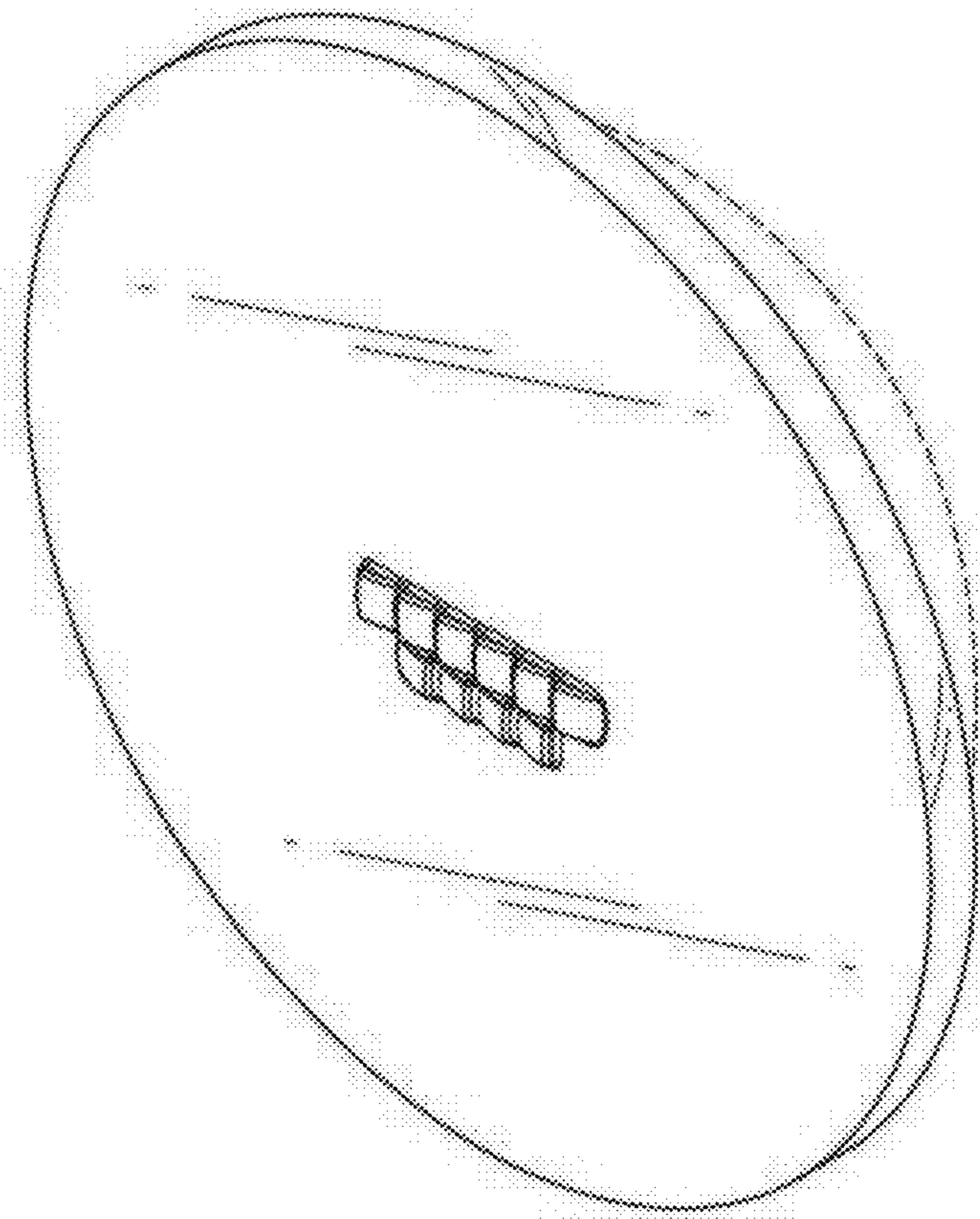

FIG. 2



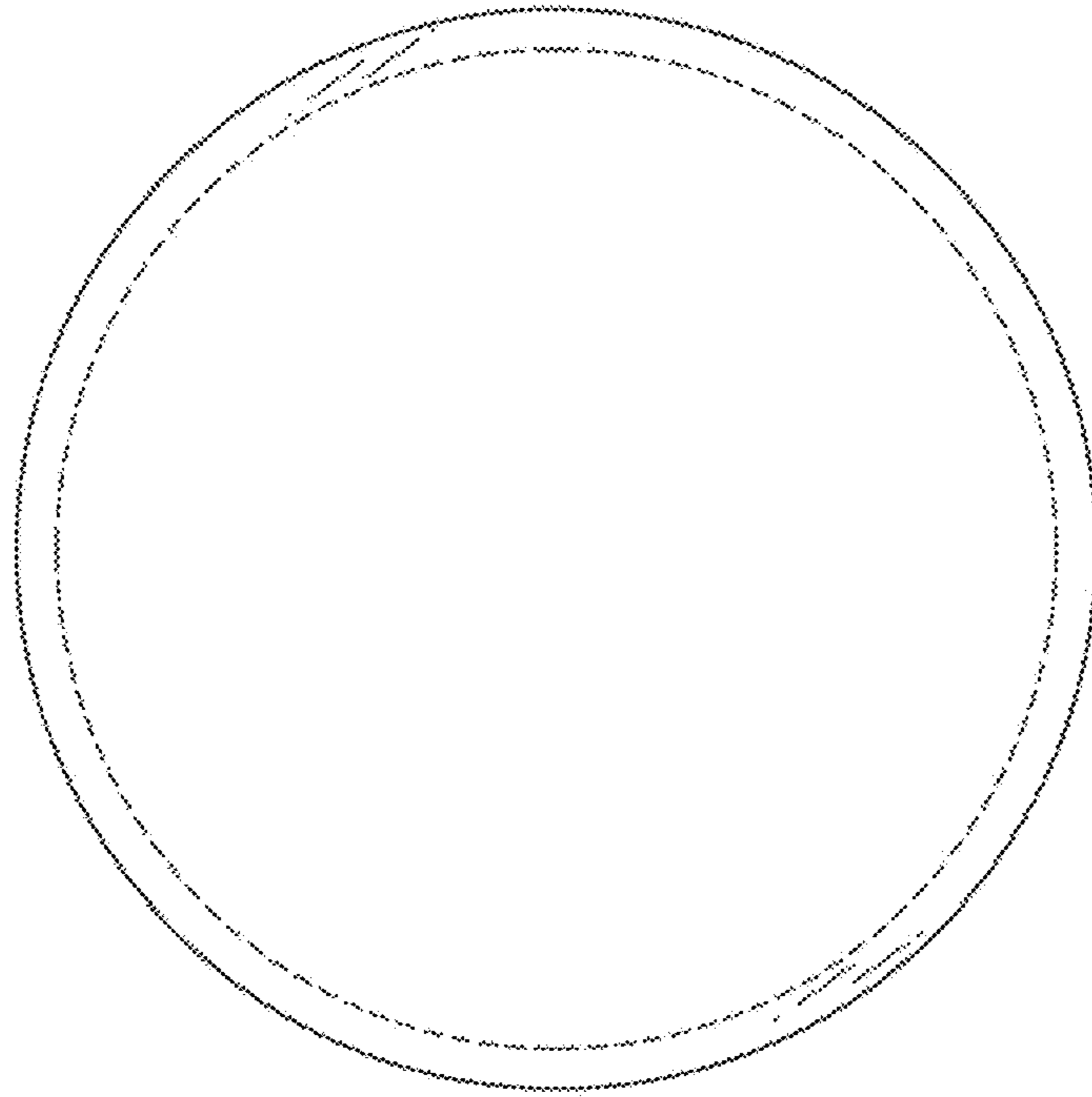
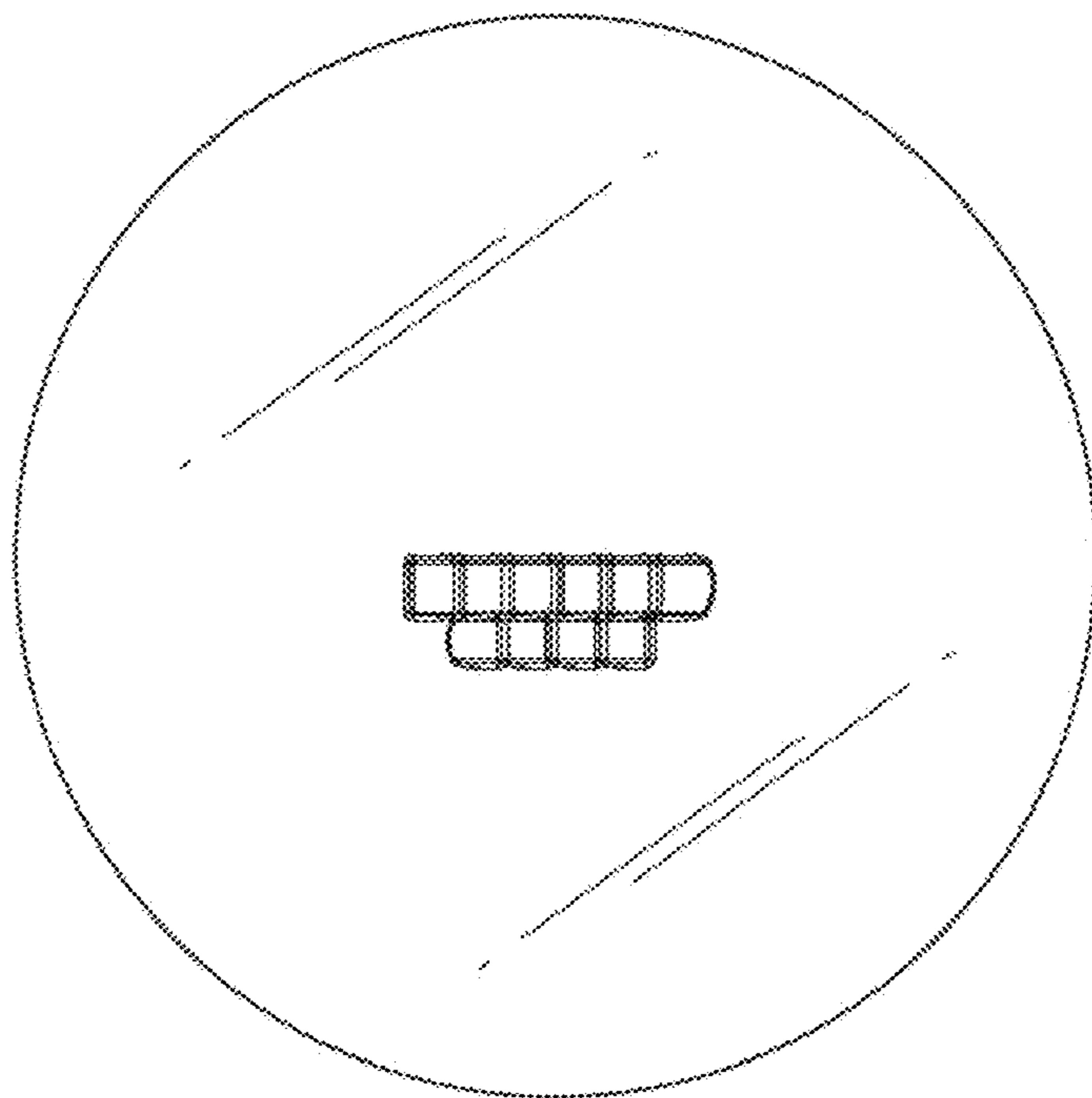

FIG. 3

FIG. 4



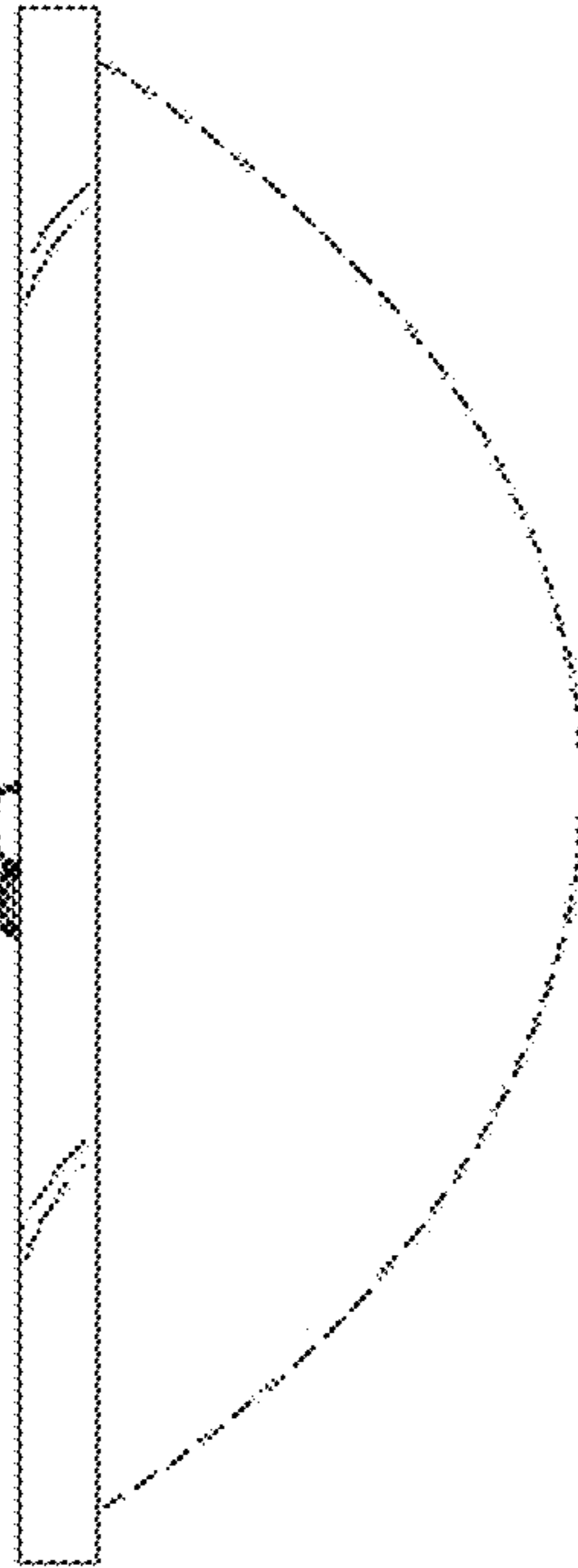
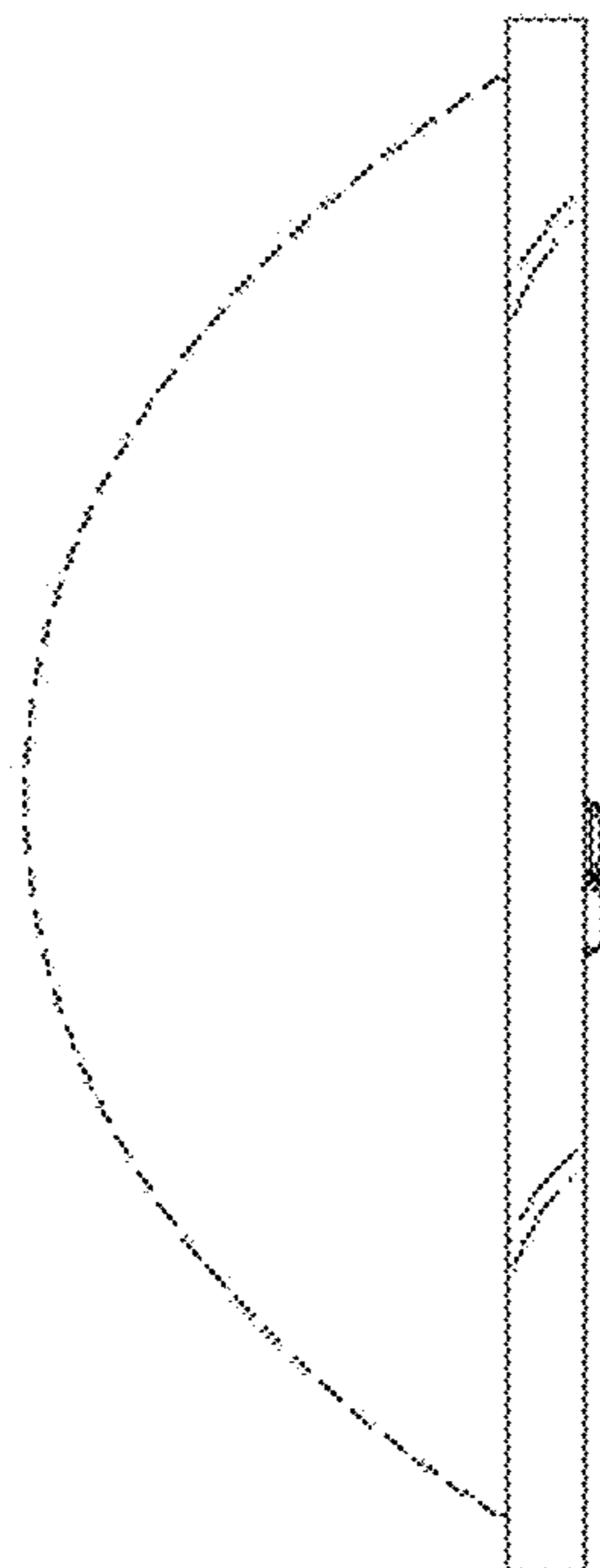

FIG. 5

FIG. 6



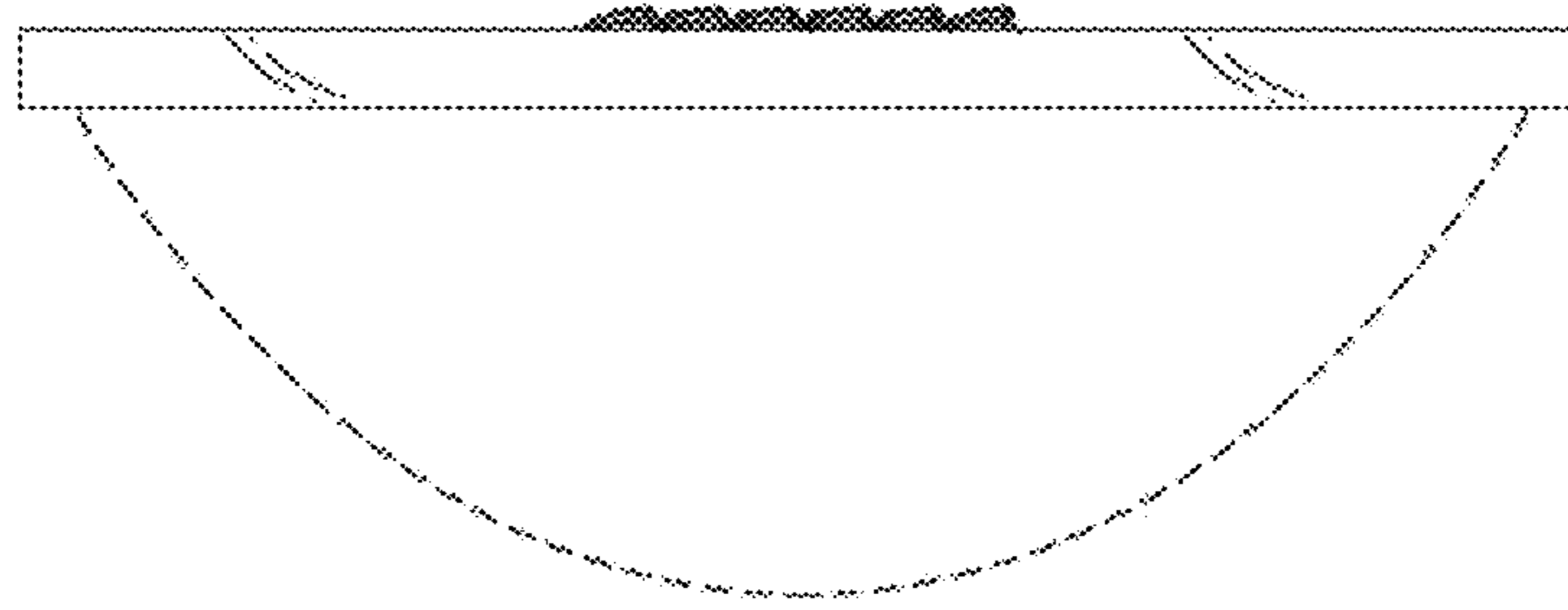

FIG. 7

FIG. 8

