



US00D846724S

(12) **United States Design Patent**
Mecker et al.

(10) **Patent No.:** **US D846,724 S**
(45) **Date of Patent:** **** Apr. 23, 2019**

(54) **DISPENSER**

FOREIGN PATENT DOCUMENTS

(71) Applicant: **S. C. JOHNSON & SON, INC.**,
Racine, WI (US)

EM 000007471-0001 4/2003
EM 000076955-0012 9/2003

(Continued)

(72) Inventors: **Alex Mecker**, Chicago, IL (US);
Gregory Pieper, Spring Grove, IL
(US); **Nick Rees**, New York, NY (US)

OTHER PUBLICATIONS

(73) Assignee: **S. C. JOHNSON & SON, INC.**,
Racine, WI (US)

“Heart Shaped Glass Craft Bottle,” theworks.co.uk. Reviewed Jul.
22, 2017. Accessed Nov. 25, 2018. 3 pages. Available online at
URL: <<https://www.theworks.co.uk/p/weddings/heart-shaped-glass-craft-bottle/5052089205826>> (year: 2017).

(Continued)

(**) Term: **15 Years**

(21) Appl. No.: **29/623,200**

Primary Examiner — Lakiya G Rogers

(22) Filed: **Oct. 23, 2017**

Assistant Examiner — John A Voytek

(51) **LOC (11) Cl.** **28-99**

(74) *Attorney, Agent, or Firm* — Quarles & Brady LLP

(52) **U.S. Cl.**
USPC **D23/366**

(57) **CLAIM**

(58) **Field of Classification Search**
USPC D23/355–370, 386–388; D21/455;
D9/434, 435, 612
CPC ... A61L 9/03; A61L 9/12; A61F 9/026; B01D
46/0004; G09F 7/22; G09F 19/08
See application file for complete search history.

The ornamental design for a dispenser, as shown and
described.

DESCRIPTION

(56) **References Cited**

U.S. PATENT DOCUMENTS

4,621,768 A	11/1986	Lhoste et al.
4,731,520 A	3/1988	Glucksman et al.
D386,974 S	12/1997	Wefler
6,104,867 A	8/2000	Stathakis et al.
D430,658 S	9/2000	Farce
D432,222 S	10/2000	Rymer et al.
D437,744 S	2/2001	Young et al.
6,236,807 B1	5/2001	Ruffolo et al.
6,278,840 B1	8/2001	Basaganas Millan
6,446,583 B2	9/2002	Vieira
D464,416 S	10/2002	von Dohlen et al.

(Continued)

FIG. 1 is an isometric view of a top, front, and right side of
an ornamental design for a dispenser;
FIG. 2 is a front elevational view of the dispenser of FIG. 1;
FIG. 3 is a rear elevational view of the dispenser of FIG. 1;
FIG. 4 is a right side elevational view of the dispenser of
FIG. 1;
FIG. 5 is a left side elevational view of the dispenser of FIG.
1;
FIG. 6 is a top plan view of the dispenser of FIG. 1; and,
FIG. 7 is a bottom plan view of the dispenser of FIG. 1.
In the drawings, the broken lines depict portions of the
dispenser that form no part of the claimed design. The dot
and dashed lines define the bounds of the claimed design and
form no part thereof.

1 Claim, 6 Drawing Sheets

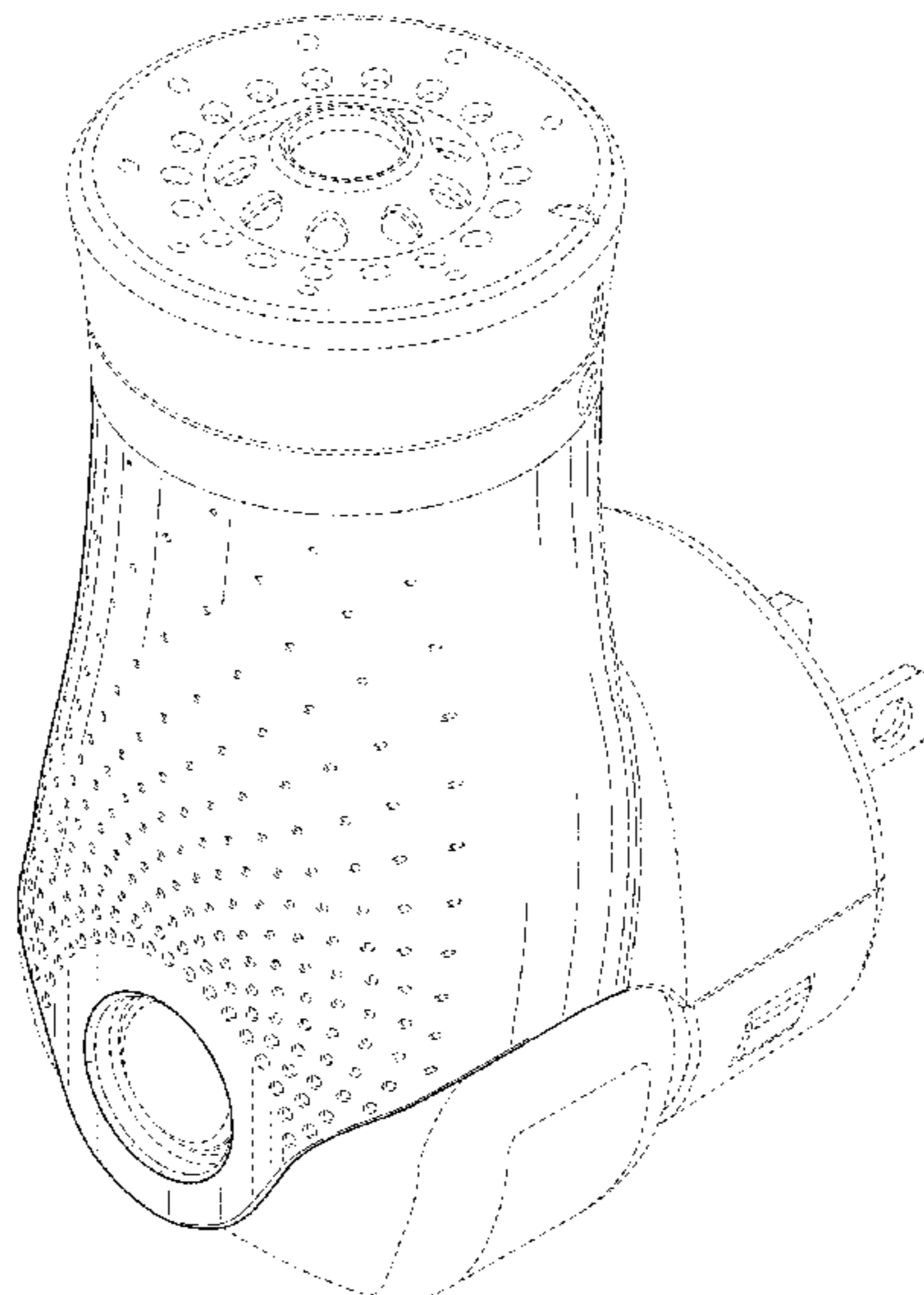

(56)

References Cited

U.S. PATENT DOCUMENTS

6,466,739 B2	10/2002	Ambrosi et al.	D597,192 S	7/2009	Drucker et al.
6,487,367 B2	11/2002	Vieira	D599,665 S	9/2009	Campbell
D468,626 S	1/2003	Jødal et al.	D603,708 S	11/2009	Handy
6,563,091 B2	5/2003	Vieira	D604,619 S	11/2009	Tebe Poves et al.
D476,069 S *	6/2003	O'Loughlin D23/366	D604,629 S	11/2009	Aebi
6,603,924 B2	8/2003	Brown et al.	D605,746 S	12/2009	Butler et al.
D480,316 S	10/2003	Wolpert et al.	D605,747 S	12/2009	Butler et al.
6,661,967 B2	12/2003	Levine et al.	7,628,338 B2	12/2009	Belongia et al.
D491,256 S	6/2004	Fellows et al.	7,631,814 B2	12/2009	Zarembinski
D492,597 S	7/2004	Norris et al.	D607,315 S	1/2010	George et al.
D501,546 S	2/2005	Cruver, IV et al.	D608,198 S	1/2010	Lohrman et al.
D501,921 S	2/2005	Caserta et al.	D608,640 S	1/2010	Carreno
D504,317 S	4/2005	Mansau	D610,249 S	2/2010	Robinson
6,889,003 B2	5/2005	Triplett et al.	D611,348 S	3/2010	Handy
D507,487 S	7/2005	Marroncles	D613,844 S	4/2010	Jorgensen
D507,636 S	7/2005	Baraky et al.	D614,755 S *	4/2010	Brewster D23/366
6,917,754 B2	7/2005	Pedrotti et al.	7,780,094 B2	8/2010	Caserta et al.
6,931,202 B2	8/2005	Pedrotti et al.	D623,284 S	9/2010	Myojin et al.
6,950,607 B2	9/2005	Yip et al.	D624,170 S	9/2010	Myojin et al.
D511,967 S	11/2005	Bodet	D624,352 S	9/2010	Lion et al.
D512,136 S	11/2005	Weller	7,802,568 B2	9/2010	Eicher et al.
D512,938 S	12/2005	Morris et al.	D624,783 S	10/2010	Lion et al.
6,988,496 B1	1/2006	Eicher et al.	D632,377 S	2/2011	Blachford et al.
D515,921 S	2/2006	Marroncles	D632,771 S	2/2011	Abbondanzio et al.
7,002,114 B2	2/2006	He et al.	D632,772 S	2/2011	Abbondanzio et al.
7,014,818 B2	3/2006	Rymer	D633,190 S	2/2011	Abbondanzio et al.
7,032,831 B2	4/2006	Duston et al.	D633,229 S	2/2011	McWillis
D523,129 S	6/2006	Caserta et al.	D634,416 S	3/2011	Abbondanzio et al.
D530,216 S	10/2006	Modjeski	D634,832 S	3/2011	Abbondanzio et al.
D532,302 S	11/2006	Moretti	D636,476 S	4/2011	Abbondanzio et al.
7,140,553 B2	11/2006	Zobebe	D636,860 S	4/2011	Abbondanzio et al.
D536,969 S	2/2007	Geier	D637,274 S	5/2011	Chan et al.
D538,915 S	3/2007	Anderson et al.	D639,923 S	6/2011	Belongia et al.
D539,892 S	4/2007	Caserta et al.	D643,102 S	8/2011	Abbondanzio et al.
D541,160 S	4/2007	Cortes	D644,313 S	8/2011	Westphal
D543,326 S	5/2007	Dretzka	D644,926 S	9/2011	Davis et al.
D544,085 S	6/2007	Schriner et al.	D645,947 S	9/2011	Sevy
D544,087 S	6/2007	Baraky et al.	D646,573 S	10/2011	Kubicek et al.
D544,592 S	6/2007	Caserta et al.	D646,768 S	10/2011	Chan et al.
D544,593 S	6/2007	Yamamoto	D647,187 S	10/2011	Chan et al.
D545,626 S	7/2007	Frank	D647,608 S *	10/2011	Young D23/366
7,244,398 B2	7/2007	Kotary et al.	D651,088 S	12/2011	Buschmann et al.
D548,317 S	8/2007	Newton et al.	D654,761 S	2/2012	Herbst
D548,318 S	8/2007	Copeman	8,141,793 B2	3/2012	Wallis et al.
D548,587 S	8/2007	DuVal et al.	D656,830 S	4/2012	Rodrigeuz
D549,596 S	8/2007	Ioannides et al.	D657,448 S	4/2012	Herfort
D551,076 S	9/2007	Bloc	D657,860 S	4/2012	Sordo et al.
7,311,883 B2	12/2007	Basaganas Milian	D658,072 S	4/2012	Davis et al.
D559,434 S	1/2008	Morris et al.	D658,315 S	4/2012	Walters
D560,018 S	1/2008	Morris et al.	D658,915 S	5/2012	Fernandes et al.
D561,021 S	2/2008	DuVal et al.	D659,267 S	5/2012	Slatkin et al.
D564,876 S	3/2008	Nickel et al.	D659,817 S	5/2012	Mandell et al.
7,341,698 B2	3/2008	Pedrotti et al.	D659,818 S	5/2012	Belongia et al.
D567,920 S *	4/2008	Cantoni D23/366	D660,996 S	5/2012	Rein
D567,921 S *	4/2008	Bellofatto D23/366	D662,237 S	6/2012	Baraky et al.
D568,978 S	5/2008	Kennedy et al.	D663,018 S	7/2012	Sordo et al.
D569,247 S	5/2008	Decottignies	8,251,299 B1	8/2012	Irvin
7,382,975 B2	6/2008	Caserta et al.	D666,706 S	9/2012	Sevy
D574,072 S	7/2008	Carlson et al.	D667,574 S	9/2012	Abbondanzio et al.
D574,199 S	8/2008	Griffith et al.	D672,481 S	12/2012	Arslanian
D575,153 S	8/2008	Caroen et al.	D672,861 S	12/2012	Adair et al.
D576,874 S	9/2008	Miller et al.	D675,308 S	1/2013	Freeborn et al.
D579,340 S	10/2008	Dickman et al.	D675,309 S	1/2013	Freeborn et al.
D580,272 S	11/2008	Weggelaar	8,348,101 B2	1/2013	Ciavarella et al.
D580,274 S	11/2008	Abel	D679,793 S	4/2013	Feiz et al.
D580,776 S	11/2008	Claughton et al.	D680,377 S	4/2013	Romley
7,455,245 B2	11/2008	Sipinski et al.	D680,637 S	4/2013	Blachford et al.
D582,278 S	12/2008	Boume	D681,182 S	4/2013	Tomas Vilarasa et al.
D582,537 S	12/2008	Kay et al.	D681,183 S	4/2013	Blachford et al.
D583,038 S	12/2008	Kay et al.	D682,448 S	5/2013	Nugent
D583,457 S	12/2008	Kay et al.	RE44,312 E	6/2013	Vieira
D584,809 S	1/2009	Porchia et al.	D686,718 S	7/2013	Gordon et al.
7,484,675 B2	2/2009	Brown	D686,721 S *	7/2013	Wirz D23/366
D587,576 S	3/2009	Miller et al.	8,485,454 B1	7/2013	Irvin et al.
D596,939 S	7/2009	Moretti	D689,364 S	9/2013	Sanders
			D689,664 S	9/2013	Dietvorst et al.
			D689,998 S	9/2013	Carbone et al.
			D691,255 S	10/2013	Abbondanzio et al.
			D692,116 S *	10/2013	Gordon D23/366

(56)

References Cited

U.S. PATENT DOCUMENTS

D699,075 S 2/2014 Mariotti
 D700,694 S * 3/2014 Sordo D23/366
 D701,120 S 3/2014 Sanders
 8,703,067 B2 4/2014 Woolley
 D707,373 S 6/2014 Nugent
 D707,805 S 6/2014 Brewer et al.
 8,746,587 B2 6/2014 Soldan et al.
 D709,761 S 7/2014 Sanders
 D710,743 S 8/2014 Bartter
 D712,739 S 9/2014 Lapsker
 D713,517 S 9/2014 Dodge et al.
 D716,148 S 10/2014 DeMarco et al.
 D716,432 S 10/2014 Viala et al.
 8,870,030 B2 10/2014 Demarest et al.
 D717,123 S 11/2014 Epstein
 D721,275 S 1/2015 Thijssen et al.
 D721,278 S 1/2015 Eble
 D723,376 S 3/2015 Adair et al.
 D724,192 S 3/2015 Mecker
 D724,945 S 3/2015 Davis et al.
 8,985,398 B2 3/2015 Demarest et al.
 8,985,405 B2 3/2015 Wanbaugh
 D729,924 S 5/2015 Hsiao
 D732,654 S * 6/2015 Hsiao D23/366
 D733,382 S 6/2015 Bos et al.
 9,061,821 B2 6/2015 Helf et al.
 D736,095 S 8/2015 Brochado et al.
 D740,163 S 10/2015 Pettigrew et al.
 D741,987 S 10/2015 Gamble et al.
 D742,561 S 11/2015 Kasha
 9,199,783 B2 12/2015 Wanbaugh et al.
 D747,212 S 1/2016 Staab
 D750,491 S 3/2016 Campbell et al.
 D750,492 S 3/2016 Campbell et al.
 D752,378 S 3/2016 Wang
 D757,560 S 5/2016 Venturini Fendi
 9,370,594 B2 6/2016 Gasper et al.
 D764,043 S 8/2016 Sanders et al.
 D764,650 S 8/2016 Sanders et al.
 D765,440 S 9/2016 Clough et al.
 D766,084 S 9/2016 Jiang
 D767,810 S 9/2016 Li
 D768,834 S 10/2016 Schuller et al.
 D770,852 S 11/2016 Vu et al.
 D776,247 S 1/2017 King et al.
 D776,800 S 1/2017 King et al.
 D781,488 S 3/2017 Patton
 D782,309 S 3/2017 Jiang
 D786,689 S 5/2017 Dalton
 D787,947 S 5/2017 Li
 D787,948 S 5/2017 Scott et al.
 D790,352 S 6/2017 Staab
 9,669,126 B2 6/2017 Jaworski et al.
 D797,916 S * 9/2017 Gobber D23/366
 2004/0067172 A1 4/2004 Ehrlich et al.
 2006/0202050 A1 9/2006 Caserta et al.
 2015/0135503 A1 5/2015 Belongia
 2016/0151528 A1 6/2016 Duffield
 2016/0205727 A1 7/2016 Meinhart et al.
 2016/0256586 A1 9/2016 Eastcott et al.
 2017/0065992 A1 3/2017 Clough et al.
 2017/0143042 A1 5/2017 Batista et al.
 2017/0150755 A1 6/2017 Batista
 2017/0159171 A1 6/2017 Tung et al.

FOREIGN PATENT DOCUMENTS

EM 000418538-0002 10/2005
 EM 000487251-0003 2/2006
 EM 000551643-0001 6/2006
 EM 000551643-0002 6/2006
 EM 000551643-0003 6/2006
 EM 000551643-0004 6/2006
 EM 000551643-0005 6/2006
 EM 000551643-0006 6/2006

EM 000688023-0009 3/2007
 EM 000755061-0001 7/2007
 EM 000873757-0001 2/2008
 EM 000983069-0003 8/2008
 EM 000983069-0004 8/2008
 EM 001171656-0003 10/2009
 EM 001239875-0006 10/2010
 EM 001239875-0007 10/2010
 EM 001239990-0001 10/2010
 EM 001239990-0002 10/2010
 EM 001239990-0003 10/2010
 EM 001239990-0004 10/2010
 EM 001239990-0005 10/2010
 EM 001239990-0007 10/2010
 EM 001239990-0008 10/2010
 EM 001239990-0009 10/2010
 EM 001239990-0012 10/2010
 EM 001239990-0013 10/2010
 EM 001251490-0001 12/2010
 EM 001251490-0002 12/2010
 EM 001251490-0003 12/2010
 EM 001251490-0004 12/2010
 EM 001797150-0001 12/2010
 EM 001797150-0002 12/2010
 EM 001271894-0001 4/2011
 EM 001917774-0001 9/2011
 EM 001948365-0001 11/2011
 EM 001977398-0002 1/2012
 EM 001977398-0003 1/2012
 EM 001977398-0005 1/2012
 EM 001977398-0006 2/2012
 EM 002021089-0001 4/2012
 EM 001342927-0001 8/2012
 EM 001342927-0002 8/2012
 EM 001342927-0003 8/2012
 EM 001342927-0004 8/2012
 EM 001343164-0004 9/2012
 EM 002162040-0001 1/2013
 EM 001361356-0001 2/2013
 EM 001361356-0002 2/2013
 EM 001361356-0003 2/2013
 EM 001361356-0004 2/2013
 EM 001381149-0001 8/2013
 EM 002330696-0001 10/2013
 EM 002330696-0002 10/2013
 EM 002354530-0001 11/2013
 EM 002354670-0001 11/2013
 EM 001421366-0002 9/2014
 EM 002604728-0001 12/2014
 EM 002604728-0002 12/2014
 EM 002840553-0016 10/2015
 EM 002971986-0001 2/2016
 EM 003422724-0001 10/2016
 EM 003850601-0022 4/2017
 EP 0736248 A1 10/1996
 EP 1270022 A1 1/2003
 WO DM/057247 7/2001
 WO 2005084721 A1 9/2005
 WO DM/075912 4/2011
 WO DM/079027 7/2012
 WO DM/079361 9/2012
 WO DM/082262 11/2013
 WO DM/086082 2/2015
 WO DM/091142 12/2015
 WO DM/089961 2/2016
 WO DM/094518 11/2016

OTHER PUBLICATIONS

“Heart Shaped Jar 220ml,” petpower.eu. Available Mar. 31, 2017. Accessed Nov. 25, 2018. 1 page. Available online via Internet Archive Wayback Machine at URL: <<https://web.archive.org/web/20170331172616/https://www.petpower.eu/product/heart-shaped-jar-220ml/>> (Year: 2017).
 “Heart Shaped Glass Craft Bottle,” theworks.co.uk, Reviewed Jul. 22, 2017, 3 pages. Retrieved on Feb. 7, 2019 from Internet. URL: <<https://www.theworks.co.uk/p/weddings/heart-shaped-glass-craft-bottle/5052089205826>>.

(56)

References Cited

OTHER PUBLICATIONS

“Heart Shaped Jar 220ml,” petpower.eu, (2017), 4 pages. Retrieved on Feb. 7, 2019 from Internet. URL: <<https://www.petpower.eu/product/heart-shaped-jar-220ml/>>.

* cited by examiner

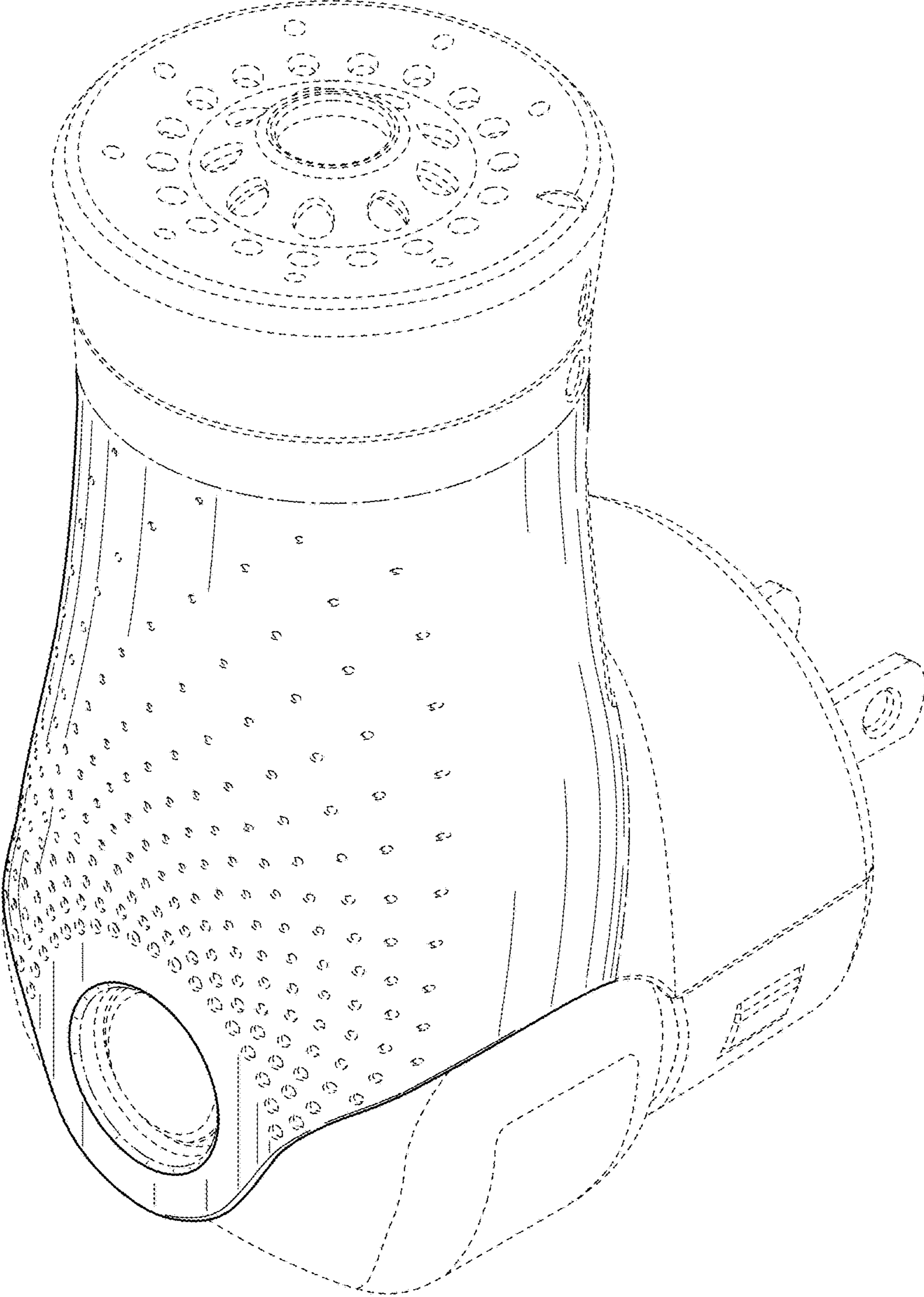

FIG. 1

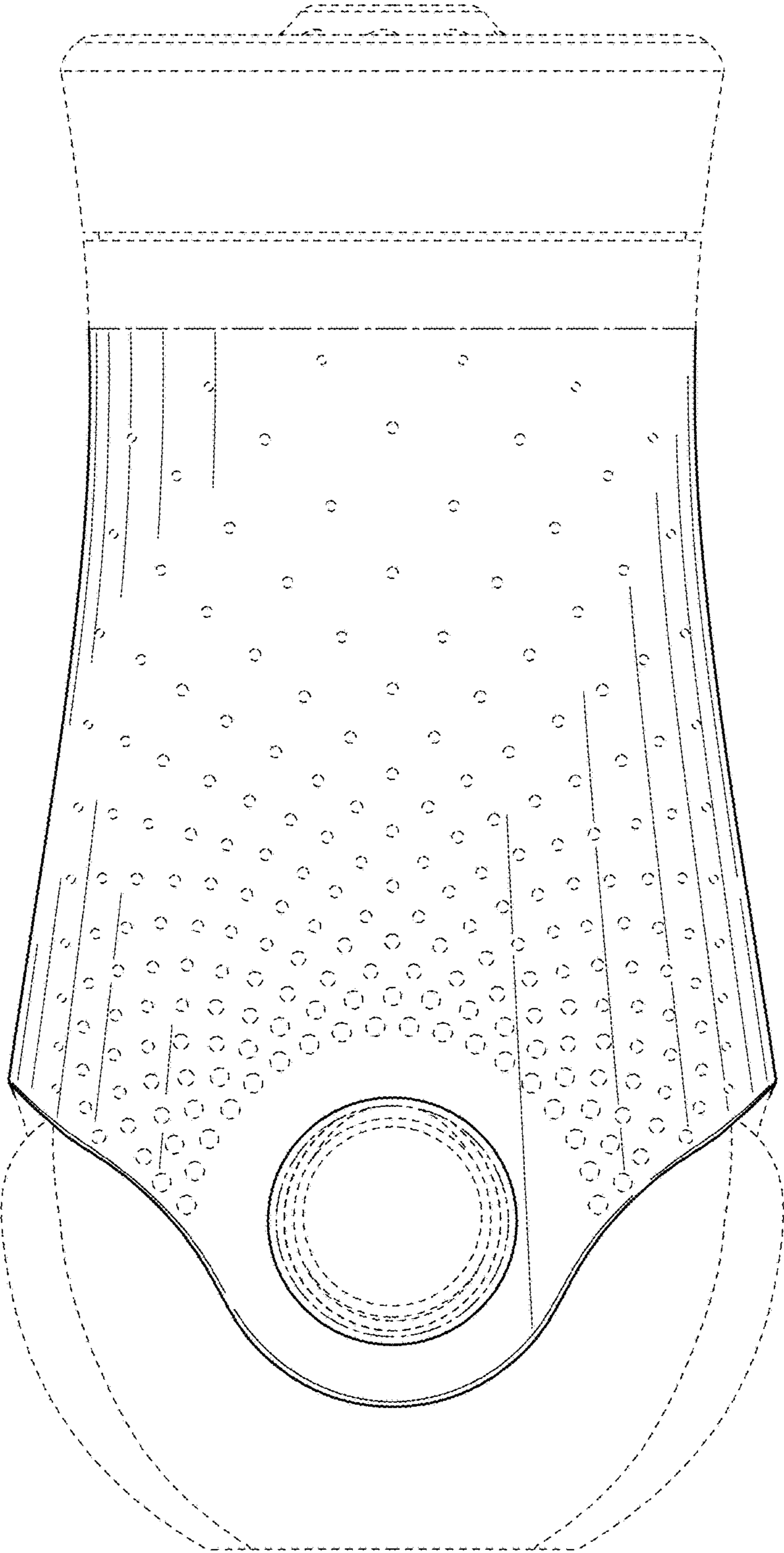

FIG. 2

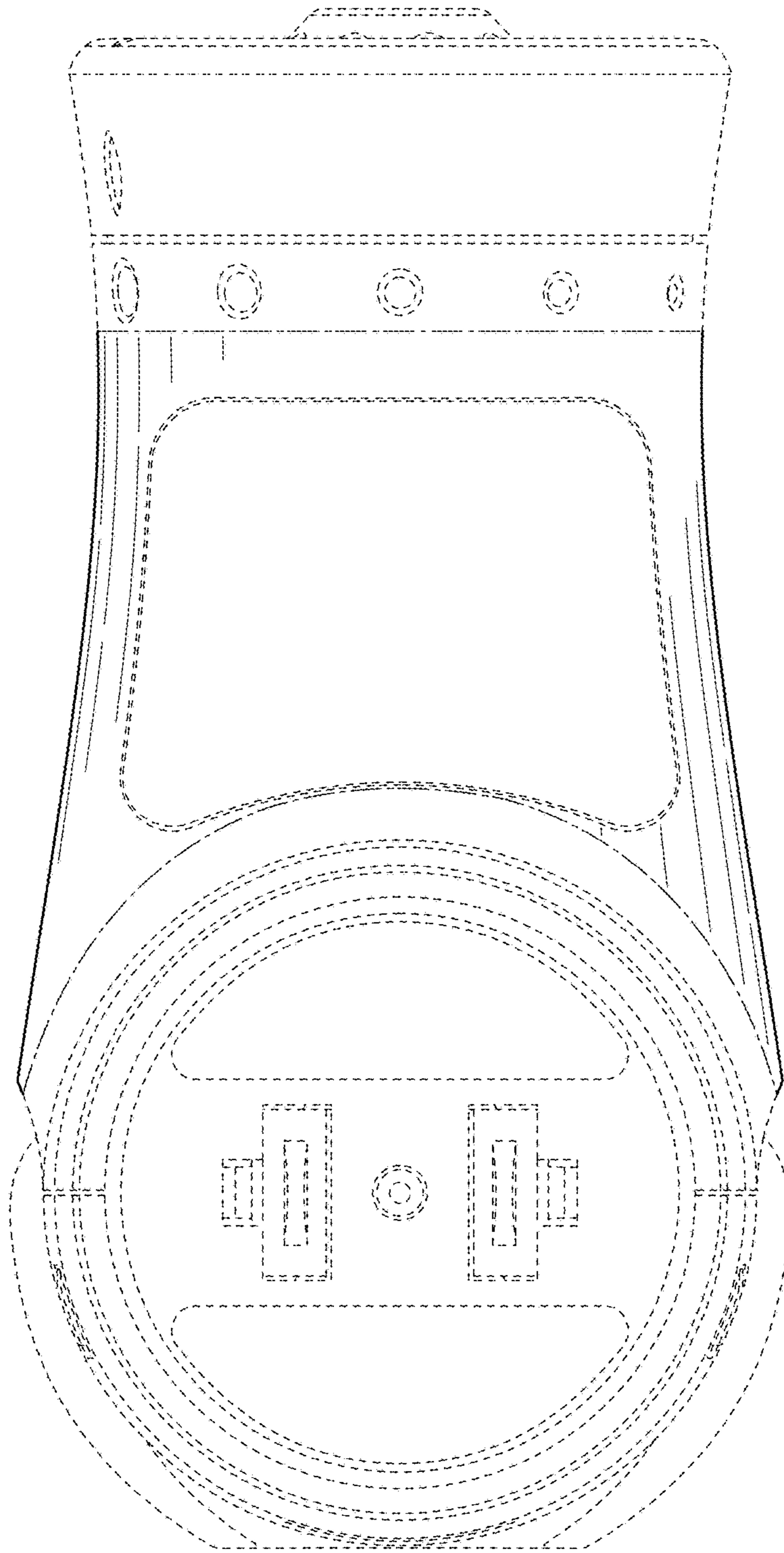

FIG. 3

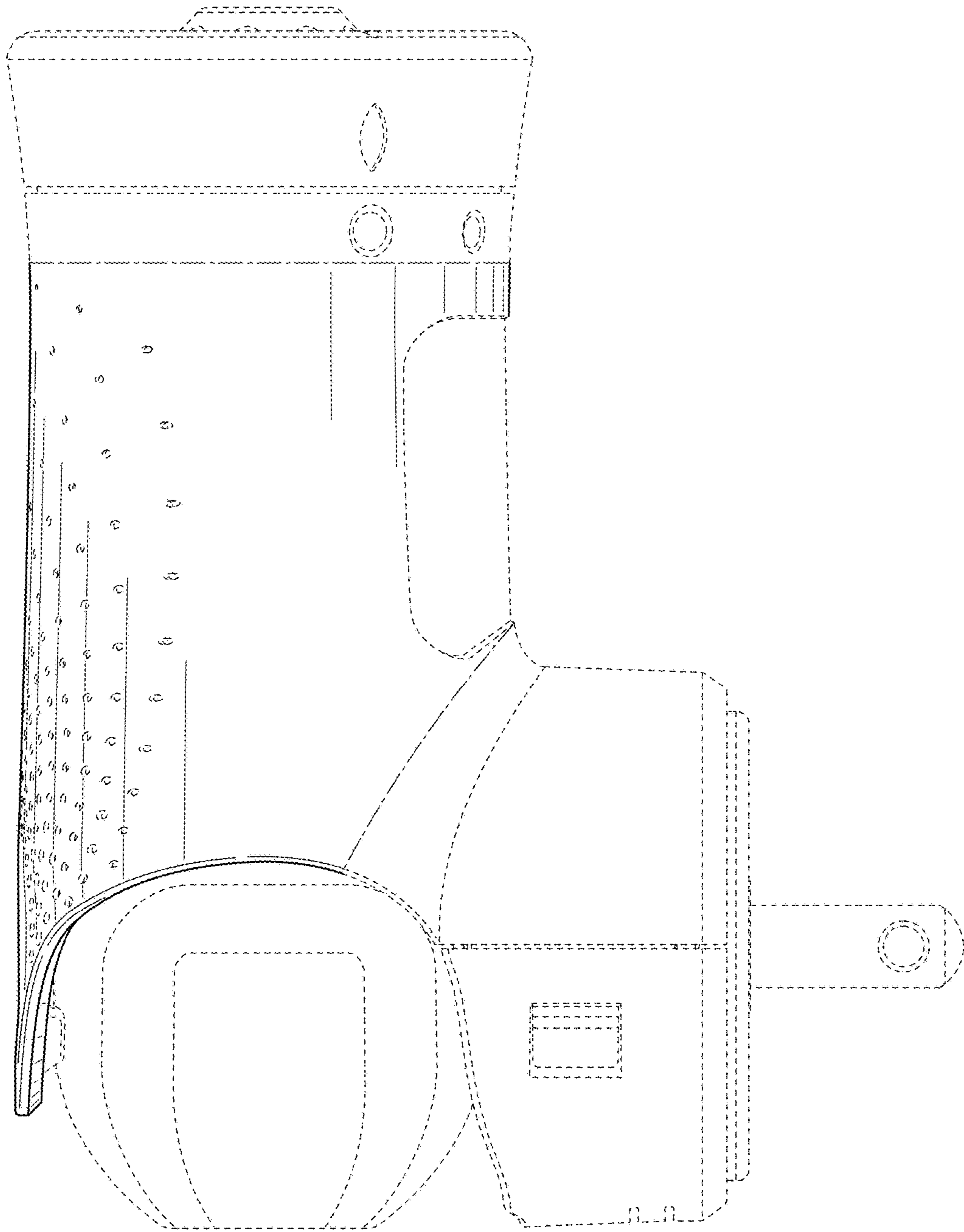

FIG. 4

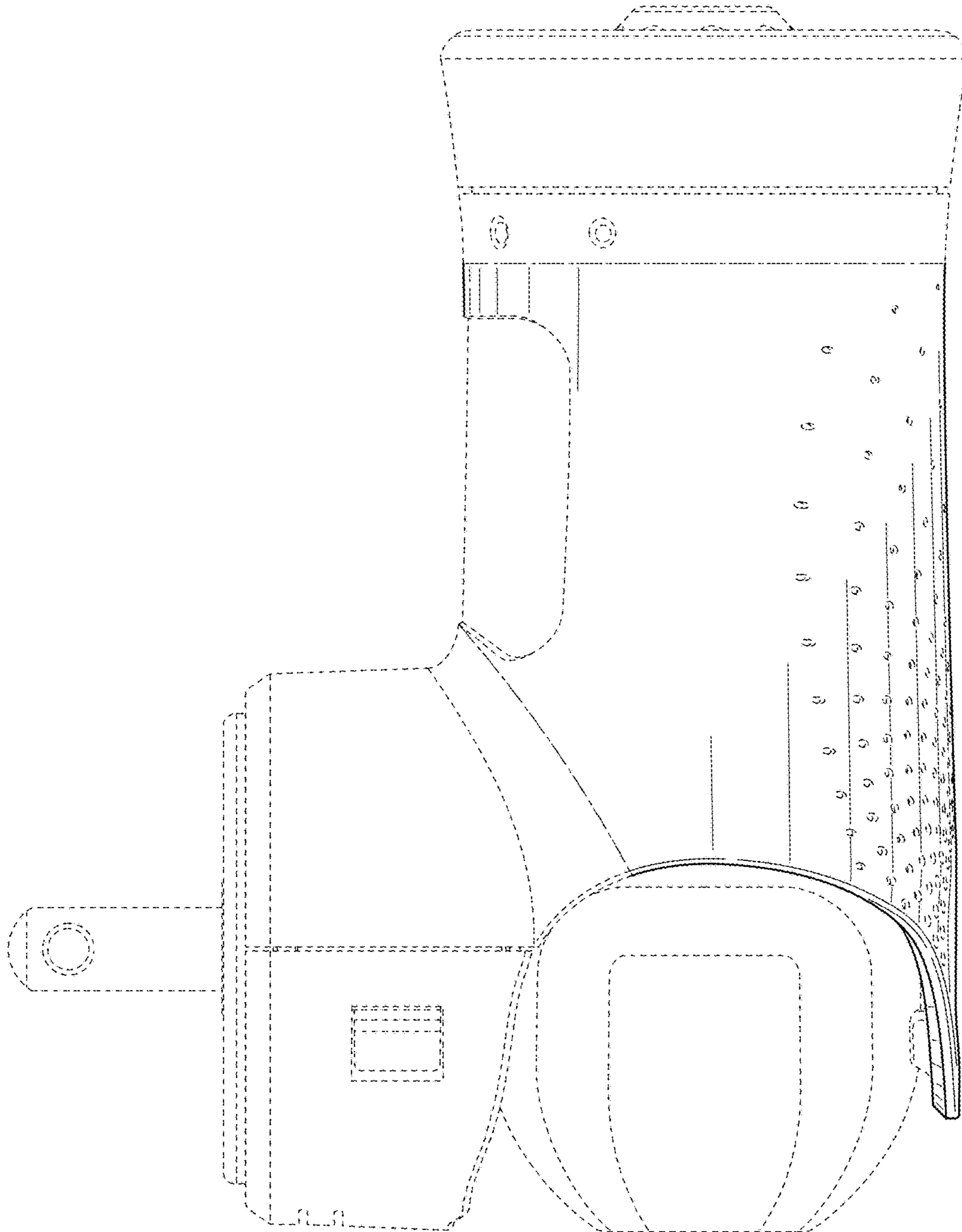

FIG. 5

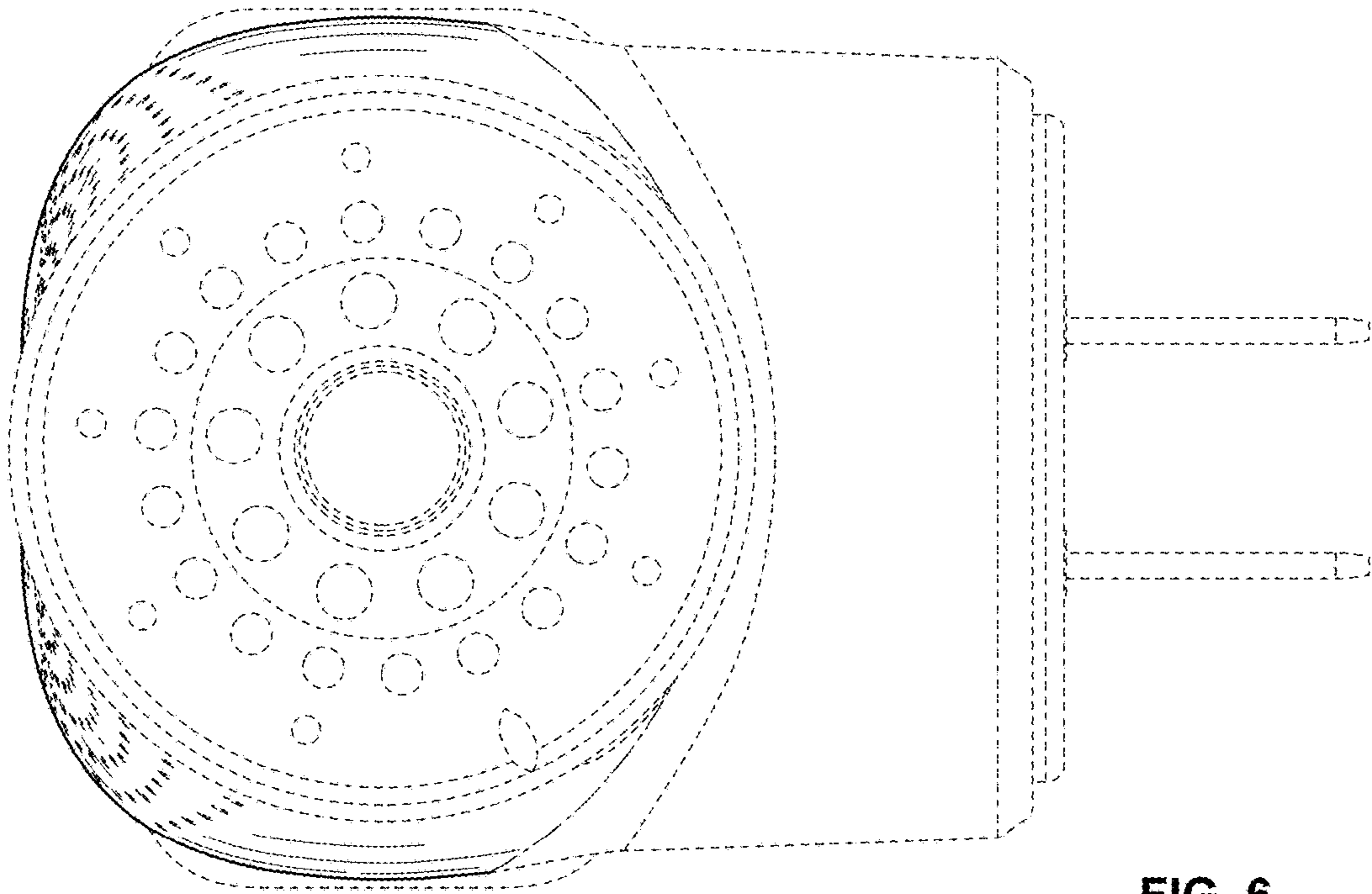

FIG. 6

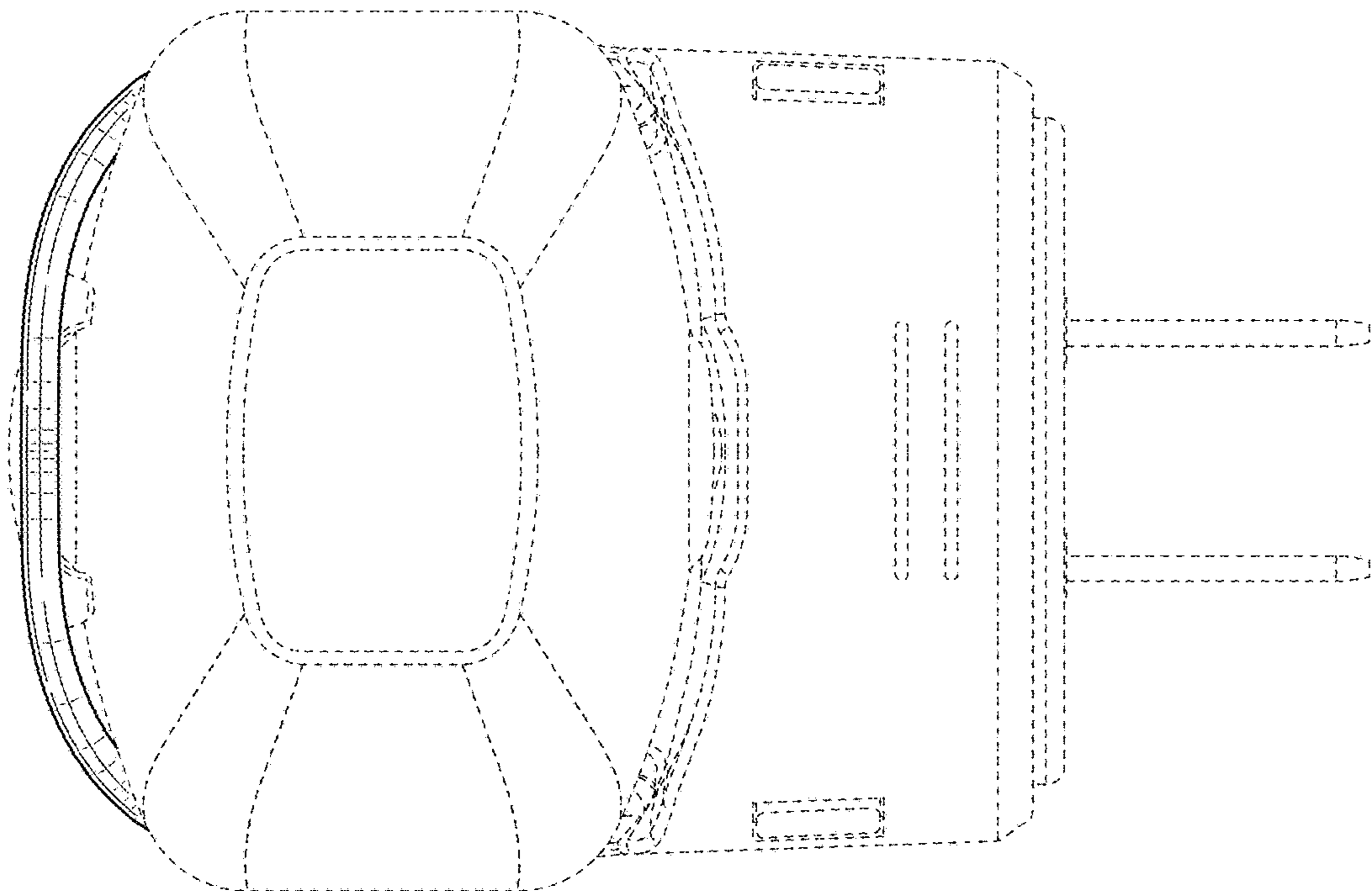

FIG. 7