



US00D846709S

(12) **United States Design Patent** (10) **Patent No.:** **US D846,709 S**  
**Chen** (45) **Date of Patent:** **\*\* Apr. 23, 2019**

- (54) **SENSOR ASSEMBLY FOR TOUCH-FREE WATER-CONTROL APPARATUS**
- (71) Applicant: **Chung-Chia Chen**, La Habra Heights, CA (US)
- (72) Inventor: **Chung-Chia Chen**, La Habra Heights, CA (US)
- (\*\*) Term: **15 Years**
- (21) Appl. No.: **29/622,934**
- (22) Filed: **Oct. 20, 2017**

**Related U.S. Application Data**

- (60) Continuation of application No. 29/592,234, filed on Jan. 27, 2017, now Pat. No. Des. 800,876, which is a continuation of application No. 29/558,607, filed on Mar. 18, 2016, now Pat. No. Des. 777,884, which is a continuation of application No. 29/509,093, filed on Nov. 13, 2014, now Pat. No. Des. 752,185, which is a continuation of application No. 29/489,642, filed on May 1, 2014, now Pat. No. Des. 735,301, which is a division of application No. 29/470,425, filed on Oct. 21, 2013, now Pat. No. Des. 704,311, which is a continuation of application No. 29/447,324, filed on Mar. 1, 2013, now Pat. No. Des. 692,110, which is a continuation of application No. 29/402,668, filed on Sep. 26, 2011, now Pat. No. Des. 677,366.
  - (51) **LOC (11) Cl.** ..... **23-01**
  - (52) **U.S. Cl.**  
USPC ..... **D23/255**
  - (58) **Field of Classification Search**  
USPC ..... D23/213, 226, 223, 228, 238-240, 255, D23/257  
CPC .... E03C 1/0409; E03C 1/0401; E03C 1/0402; E03C 1/0404; F16K 31/602; F16K 31/605; F16K 31/607
- See application file for complete search history.

(56) **References Cited**  
U.S. PATENT DOCUMENTS

- 4,186,761 A 2/1980 Guarnieri
  - D315,397 S 3/1991 Knapp
  - D317,971 S 7/1991 Sauter et al.
- (Continued)

FOREIGN PATENT DOCUMENTS

- CN 2584985 11/2003
  - CN 2906258 5/2007
- (Continued)

OTHER PUBLICATIONS

U.S. Appl. No. 29/570,426, filed Jul. 7, 2016, Chen.  
(Continued)

*Primary Examiner* — Robert A Delehanty  
(74) *Attorney, Agent, or Firm* — Knobbe Martens Olson & Bear, LLP

(57) **CLAIM**  
I claim the ornamental design for a sensor assembly for touch-free water-control apparatus, as shown and described.

**DESCRIPTION**

FIG. 1 is a perspective view of a sensor assembly for touch-free water-control apparatus showing my new design; FIG. 2 is a front elevation view thereof; FIG. 3 is a rear elevation view thereof; FIG. 4 is a left elevation view thereof; FIG. 5 is a right elevation view thereof; FIG. 6 is a top plan view thereof; and, FIG. 7 is a bottom plan view thereof.  
The broken lines showing a portion of a faucet are included for the purpose of illustrating a portion of a faucet that forms no part of the claimed design.

**1 Claim, 4 Drawing Sheets**

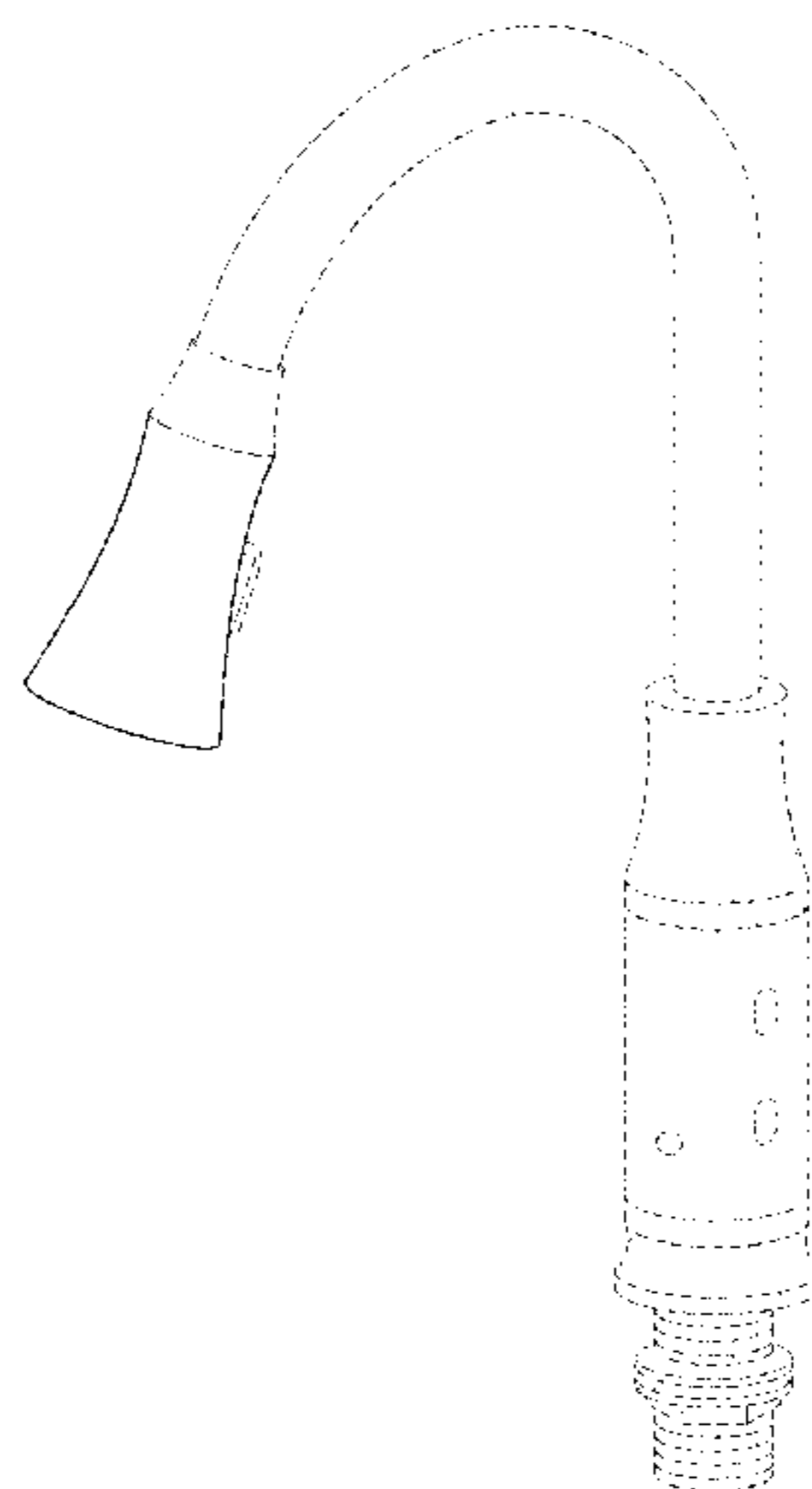

(56)

References Cited

U.S. PATENT DOCUMENTS

D352,095 S 11/1994 Bollenbacher  
 5,548,119 A 8/1996 Nortier  
 5,549,273 A 8/1996 Aharon  
 5,566,702 A 10/1996 Philipp  
 5,586,746 A 12/1996 Humpert et al.  
 5,625,908 A 5/1997 Shaw  
 5,694,653 A 12/1997 Harald  
 5,730,165 A 3/1998 Philipp  
 5,781,942 A 7/1998 Allen et al.  
 5,868,311 A 2/1999 Cretu-Petra  
 5,901,384 A 5/1999 Sim  
 5,966,753 A 10/1999 Gauthier et al.  
 6,019,130 A 2/2000 Rump  
 6,026,843 A 2/2000 Pozniak et al.  
 6,219,857 B1 4/2001 Wu  
 6,298,875 B1 10/2001 Warshawsky et al.  
 6,321,785 B1 11/2001 Bergmann  
 6,513,787 B1 2/2003 Jeromson et al.  
 6,598,245 B2 7/2003 Nishioka  
 6,753,554 B1 6/2004 Gomes et al.  
 6,996,863 B2 2/2006 Kaneko  
 D516,675 S 3/2006 Kakihana  
 D519,190 S \* 4/2006 Lord ..... D23/238  
 7,107,631 B2 9/2006 Lang et al.  
 7,134,451 B1 11/2006 Malapanes  
 D534,622 S 1/2007 Chu et al.  
 D535,357 S \* 1/2007 Zhou ..... D23/238  
 D535,366 S 1/2007 Sedwick  
 7,174,577 B2 2/2007 Jost et al.  
 7,228,874 B2 6/2007 Bolderheij et al.  
 7,232,111 B2 6/2007 McDaniel et al.  
 7,326,334 B2 2/2008 Boyd et al.  
 D581,486 S \* 11/2008 Fulford ..... D23/226  
 7,445,024 B2 11/2008 Paterson et al.  
 D592,286 S \* 5/2009 Berberet ..... D23/255  
 D602,125 S 10/2009 Montgomery et al.  
 7,641,173 B2 1/2010 Goodman  
 D610,653 S \* 2/2010 Schoenherr ..... D23/238  
 7,690,395 B2 4/2010 Jonte et al.  
 7,766,026 B2 8/2010 Boey  
 7,784,481 B2 8/2010 Kunkel  
 7,946,504 B2 5/2011 Shapira et al.  
 8,006,712 B2 8/2011 Boey  
 8,028,355 B2 10/2011 Reeder et al.  
 D677,366 S \* 3/2013 Chen ..... D23/255  
 D677,367 S 3/2013 Chen  
 8,418,993 B2 4/2013 Chen et al.  
 8,438,672 B2 5/2013 Reeder et al.  
 8,516,628 B2 8/2013 Conroy  
 D689,596 S 9/2013 Chen  
 D691,708 S \* 10/2013 Georgeson ..... D23/255  
 D692,110 S 10/2013 Chen  
 8,572,772 B2 11/2013 Wolf et al.  
 D698,013 S 1/2014 Chen  
 D701,942 S \* 4/2014 Flowers ..... D23/255  
 D701,947 S 4/2014 Chen  
 D704,311 S 5/2014 Chen  
 D707,798 S \* 6/2014 Chen ..... D23/255  
 8,827,239 B2 9/2014 Chen  
 8,827,240 B2 9/2014 Chen  
 8,950,730 B2 2/2015 Bedolla et al.  
 9,057,183 B2 6/2015 Chen  
 9,062,790 B2 6/2015 Esche et al.  
 D735,300 S 7/2015 Chen

D735,301 S 7/2015 Chen  
 9,194,110 B2 11/2015 Frick et al.  
 D752,185 S 3/2016 Chen  
 9,347,207 B2 5/2016 Chen  
 D761,390 S 7/2016 Chen  
 D777,884 S 1/2017 Chen  
 9,551,137 B2 1/2017 Chen  
 D786,408 S 5/2017 Chen  
 D800,876 S \* 10/2017 Chen ..... D23/255  
 9,840,833 B2 12/2017 Chen  
 2005/0199842 A1 9/2005 Parsons et al.  
 2006/0016902 A1 1/2006 Restivo, Sr. et al.  
 2007/0057215 A1 3/2007 Parsons et al.  
 2007/0157978 A1 7/2007 Jonte  
 2007/0170384 A1 7/2007 Goodman  
 2007/0239143 A1 10/2007 Altshuler et al.  
 2007/0251468 A1 11/2007 Houle  
 2008/0156017 A1 7/2008 Johnson et al.  
 2008/0156384 A1 7/2008 Chen  
 2008/0256494 A1 10/2008 Greenfield  
 2009/0014654 A1 1/2009 Zhevelev et al.  
 2009/0056011 A1 3/2009 Wolf et al.  
 2009/0119832 A1 5/2009 Conroy  
 2009/0288712 A1 11/2009 Lang et al.  
 2010/0071126 A1 3/2010 Rüdissler  
 2010/0108165 A1 5/2010 Rodenbeck et al.  
 2011/0162727 A1 7/2011 Stieb  
 2011/0166714 A1 7/2011 Stachnik  
 2011/0186161 A1 \* 8/2011 Chen ..... E03C 1/057  
 137/637  
 2012/0055557 A1 3/2012 Belz et al.  
 2012/0299736 A1 11/2012 Scharf  
 2012/0305118 A1 12/2012 Itazu et al.  
 2013/0233387 A1 9/2013 Bedolla et al.  
 2013/0248033 A1 9/2013 Parikh et al.  
 2013/0248617 A1 9/2013 Sawaski et al.  
 2013/0269799 A1 10/2013 Swist  
 2014/0290774 A1 10/2014 Chung  
 2015/0052677 A1 2/2015 Chen  
 2015/0101122 A1 4/2015 Chung  
 2015/0233100 A1 8/2015 Loeck et al.  
 2015/0376880 A1 12/2015 Chen  
 2016/0032572 A1 2/2016 Chen  
 2016/0340879 A1 11/2016 Chen  
 2017/0218608 A1 8/2017 Chen  
 2017/0292253 A1 10/2017 Chen

FOREIGN PATENT DOCUMENTS

JP 1993-331888 12/1993  
 JP 11-107339 4/1999  
 JP 3189957 B2 5/2001  
 JP 2004-293207 10/2004  
 JP 2006-169950 6/2006  
 JP 2007-138574 6/2007  
 JP 2007-270538 10/2007  
 JP 2007-315041 12/2007  
 WO WO 2008/094651 8/2008

OTHER PUBLICATIONS

U.S. Appl. No. 15/288,888, filed Oct. 7, 2016, Chen.  
 U.S. Appl. No. 15/411,778, filed Jan. 20, 2017, Chen.  
 U.S. Appl. No. 29/603,275, filed May 8, 2017, Chen.  
 U.S. Appl. No. 15/834,584, filed Dec. 7, 2017, Chen.

\* cited by examiner

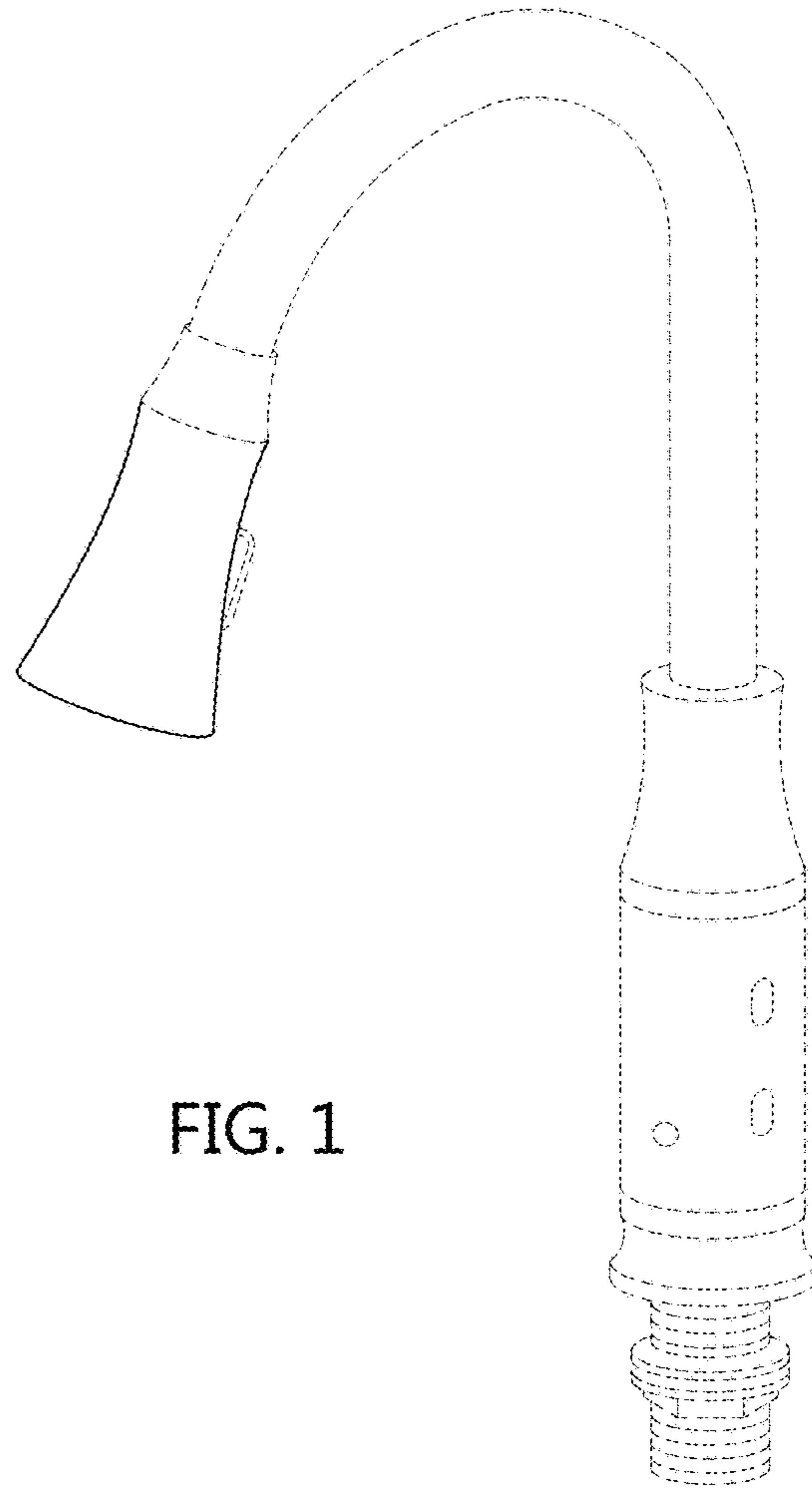

FIG. 1

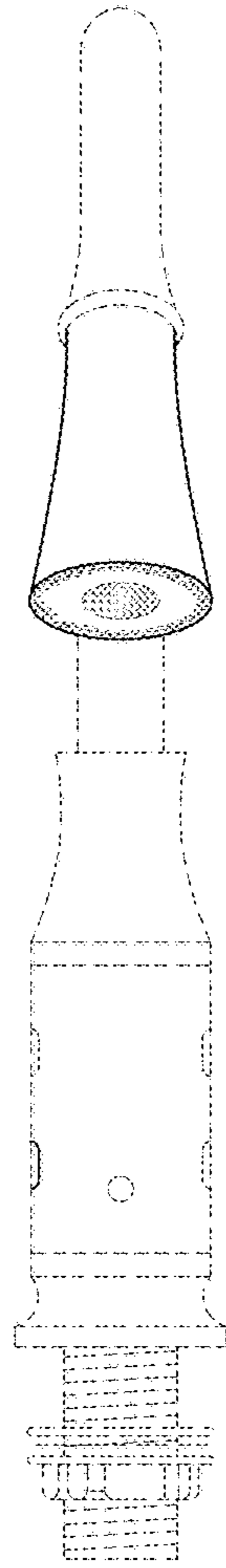

FIG. 2

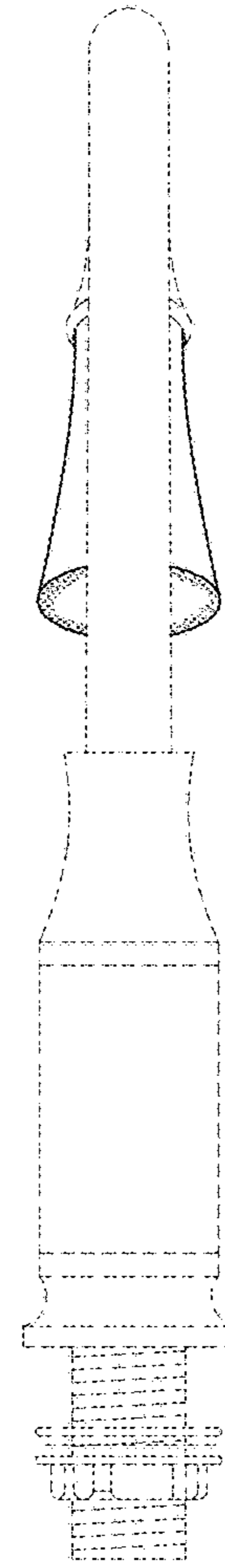

FIG. 3

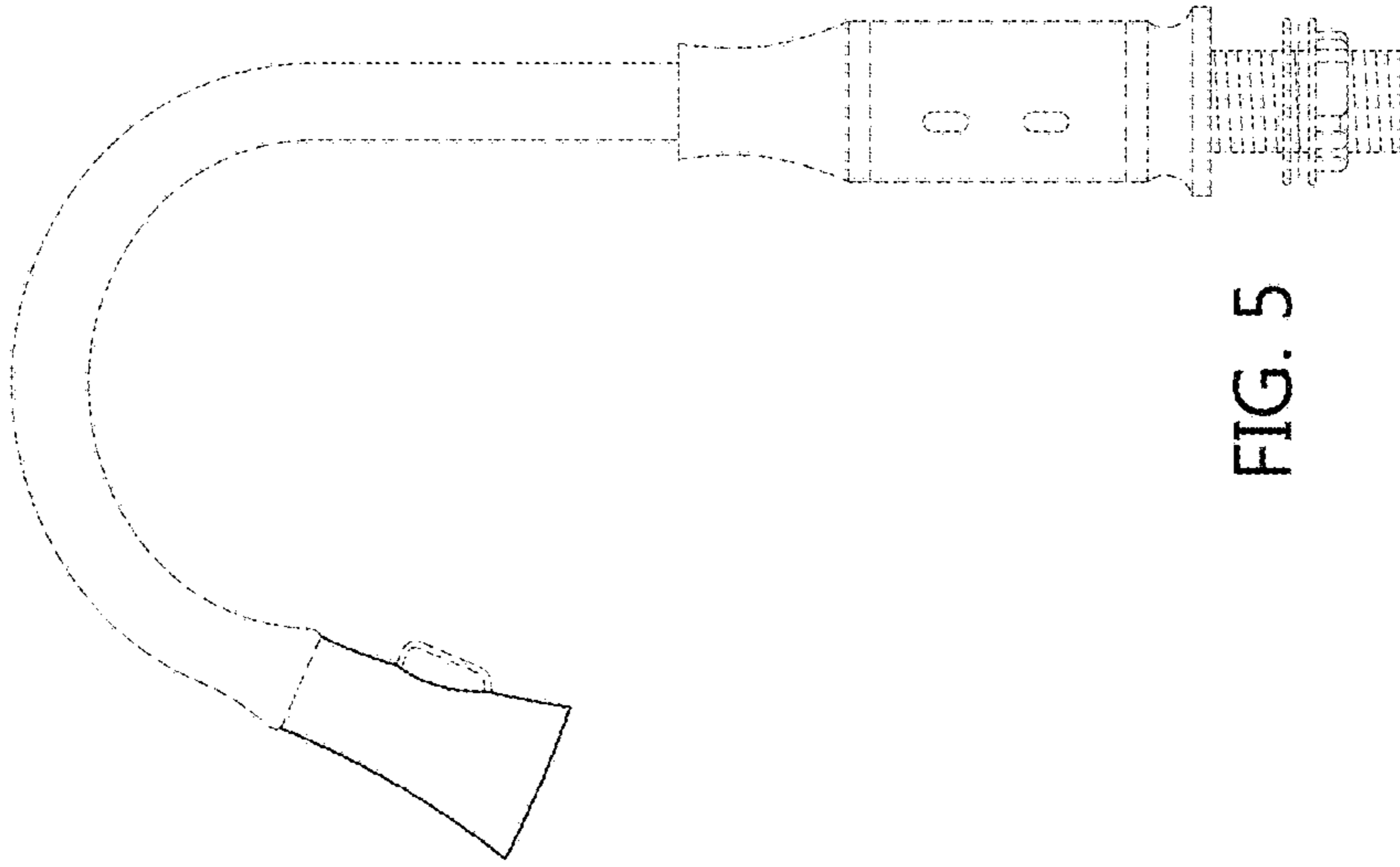

FIG. 5

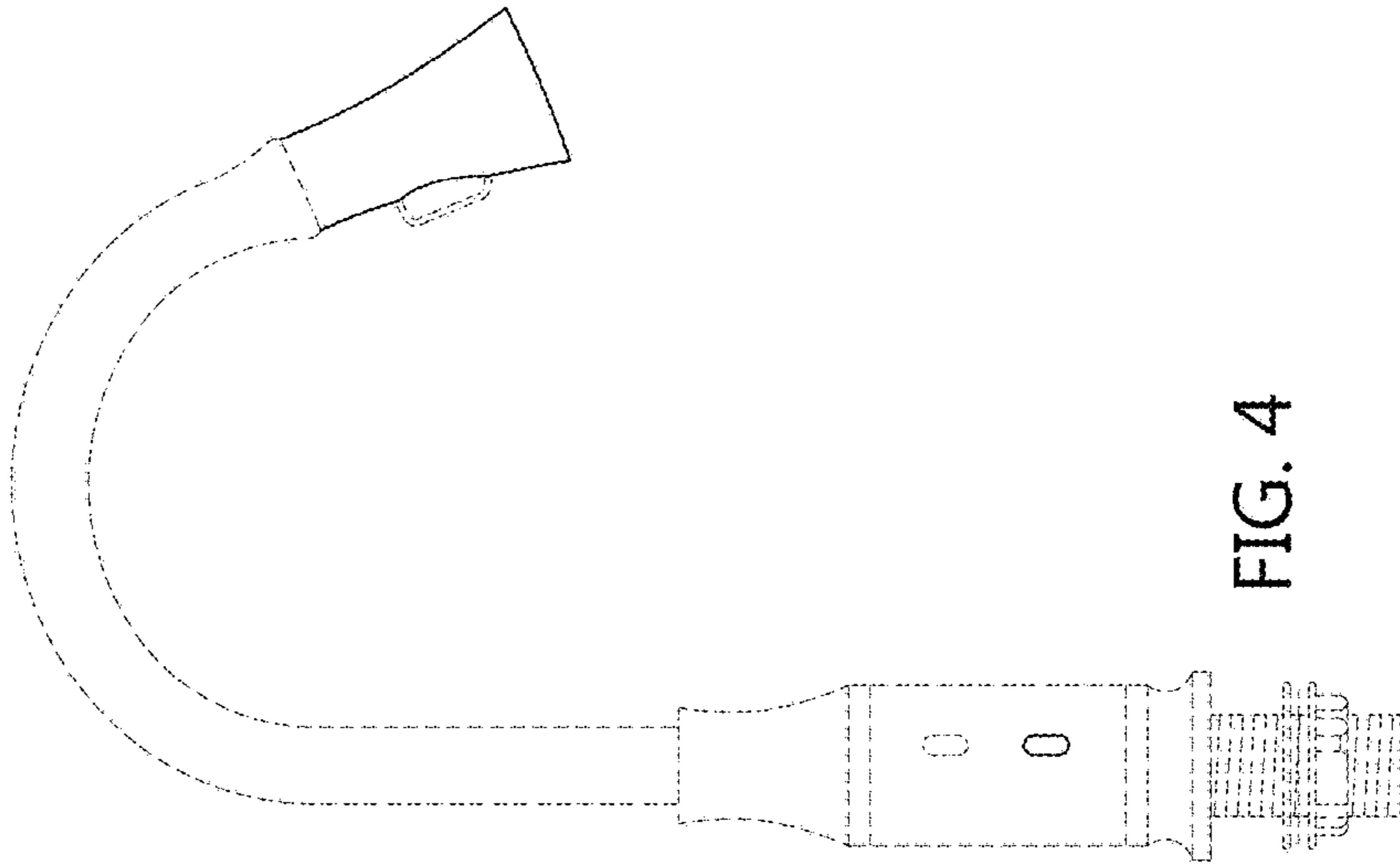

FIG. 4

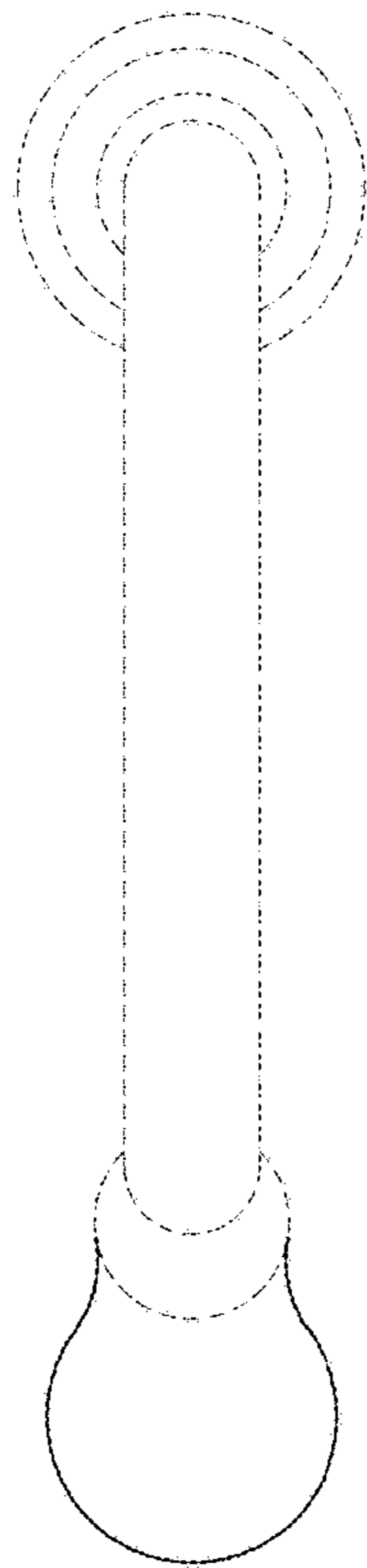

FIG. 6

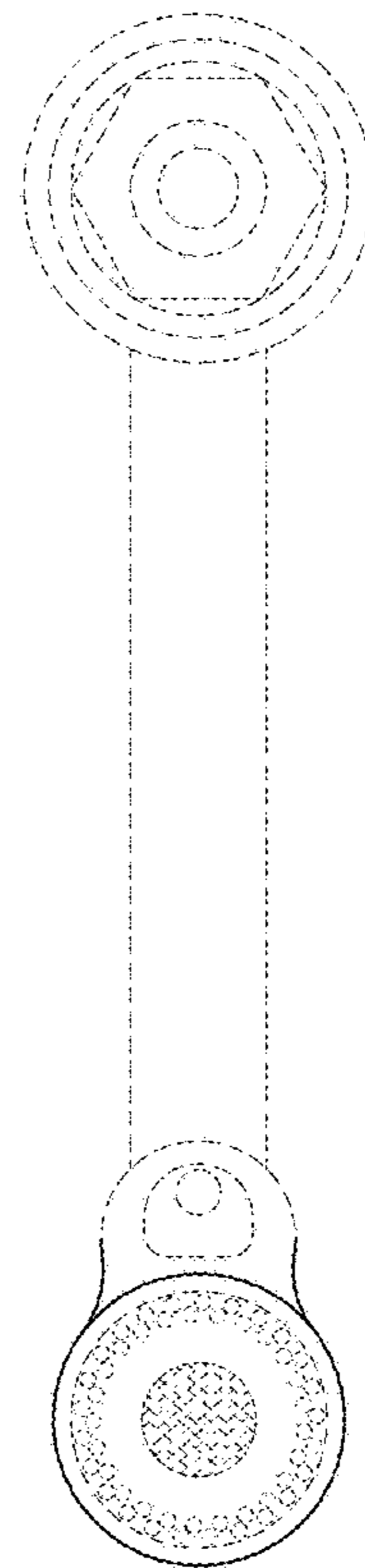

FIG. 7