



US00D846656S

(12) **United States Design Patent**  
**Horikoshi**

(10) **Patent No.:** **US D846,656 S**  
(45) **Date of Patent:** **\*\* Apr. 23, 2019**

(54) **SPINNING TOP TOY**

(71) Applicant: **TOMY COMPANY, LTD.**, Tokyo (JP)

(72) Inventor: **Kenji Horikoshi**, Tokyo (JP)

(73) Assignee: **TOMY COMPANY, LTD.**, Tokyo (JP)

(\*\*) Term: **15 Years**

(21) Appl. No.: **29/620,134**

(22) Filed: **Jul. 15, 2016**

(30) **Foreign Application Priority Data**

Mar. 4, 2016 (JP) ..... 2016-004942

(51) **LOC (11) Cl.** ..... **21-01**

(52) **U.S. Cl.**  
USPC ..... **D21/460**

(58) **Field of Classification Search**  
USPC ..... D21/436, 441, 443, 444, 455, 460-464;  
446/236-266

(Continued)

(56) **References Cited**

**U.S. PATENT DOCUMENTS**

D615,134 S \* 5/2010 Nishimoto ..... D21/460  
D629,051 S \* 12/2010 Nishimoto ..... D21/460

(Continued)

**FOREIGN PATENT DOCUMENTS**

CA 2857579 A1 \* 6/2013 ..... A63H 1/18  
CN 300862260 \* 12/2008

(Continued)

*Primary Examiner* — Catherine A Tuttle

(74) *Attorney, Agent, or Firm* — Staas & Halsey LLP

(57) **CLAIM**

The ornamental design for a spinning top toy, as shown and described.

**DESCRIPTION**

FIG. 1 is a front view of the spinning top toy showing our design;

FIG. 2 is a left side view thereof;

FIG. 3 is a rear view thereof;

FIG. 4 is right side view thereof;

FIG. 5 is a top view thereof;

FIG. 6 is a bottom view thereof;

FIG. 7 is a perspective view thereof;

FIG. 8 is a front elevational view of the transparent portion of the design shown in isolation for clarity of disclosure;

FIG. 9 is a front view of the spinning top toy, corresponding to FIG. 1 but showing contour shading to the exterior parts and with the interior parts omitted;

FIG. 10 is a left side view thereof corresponding to FIG. 2 but showing contour shading to the exterior parts and with the interior parts omitted for clarity of disclosure;

FIG. 11 is a rear view thereof corresponding to FIG. 3 but showing contour shading to the exterior parts and with the interior parts omitted for clarity of disclosure;

FIG. 12 is right side view thereof corresponding to FIG. 4 but showing contour shading to the exterior parts and with the interior parts omitted for clarity of disclosure;

FIG. 13 is a top view thereof corresponding to FIG. 5 but showing contour shading to the exterior parts and with the interior parts omitted for clarity of disclosure;

FIG. 14 is a bottom view thereof corresponding to FIG. 6 but showing contour shading to the exterior parts and with the interior parts omitted for clarity of disclosure;

FIG. 15 is a perspective view thereof corresponding to FIG. 7 but showing contour shading to the exterior parts and with the interior parts omitted for clarity of disclosure; and,

FIG. 16 is a front elevational view corresponding to FIG. 8, but showing contour shading to the exterior parts and with the interior parts omitted for clarity of disclosure.

The portions of the spinning top toy shown in broken lines form no part of the claimed design.

**1 Claim, 16 Drawing Sheets**

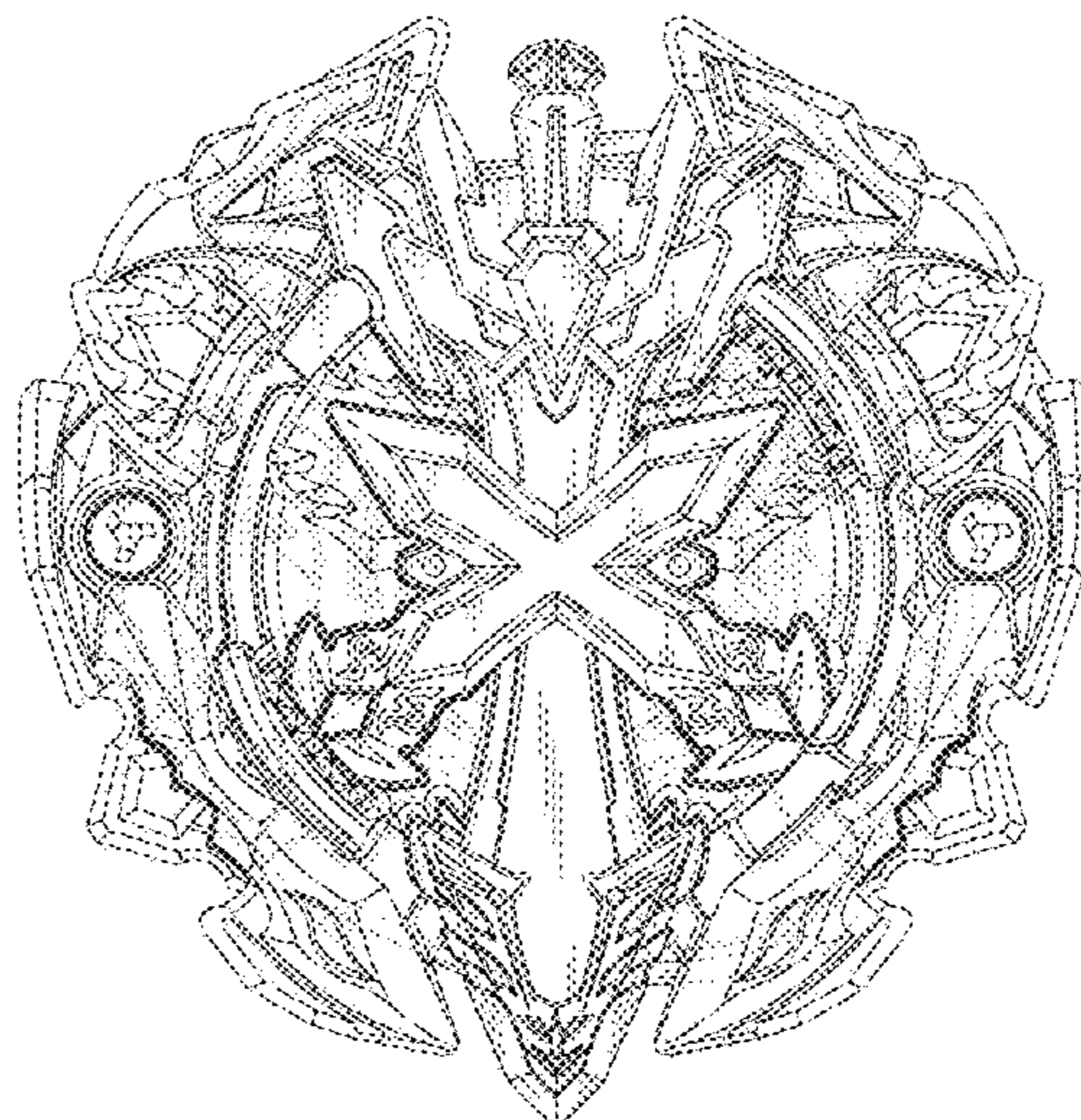
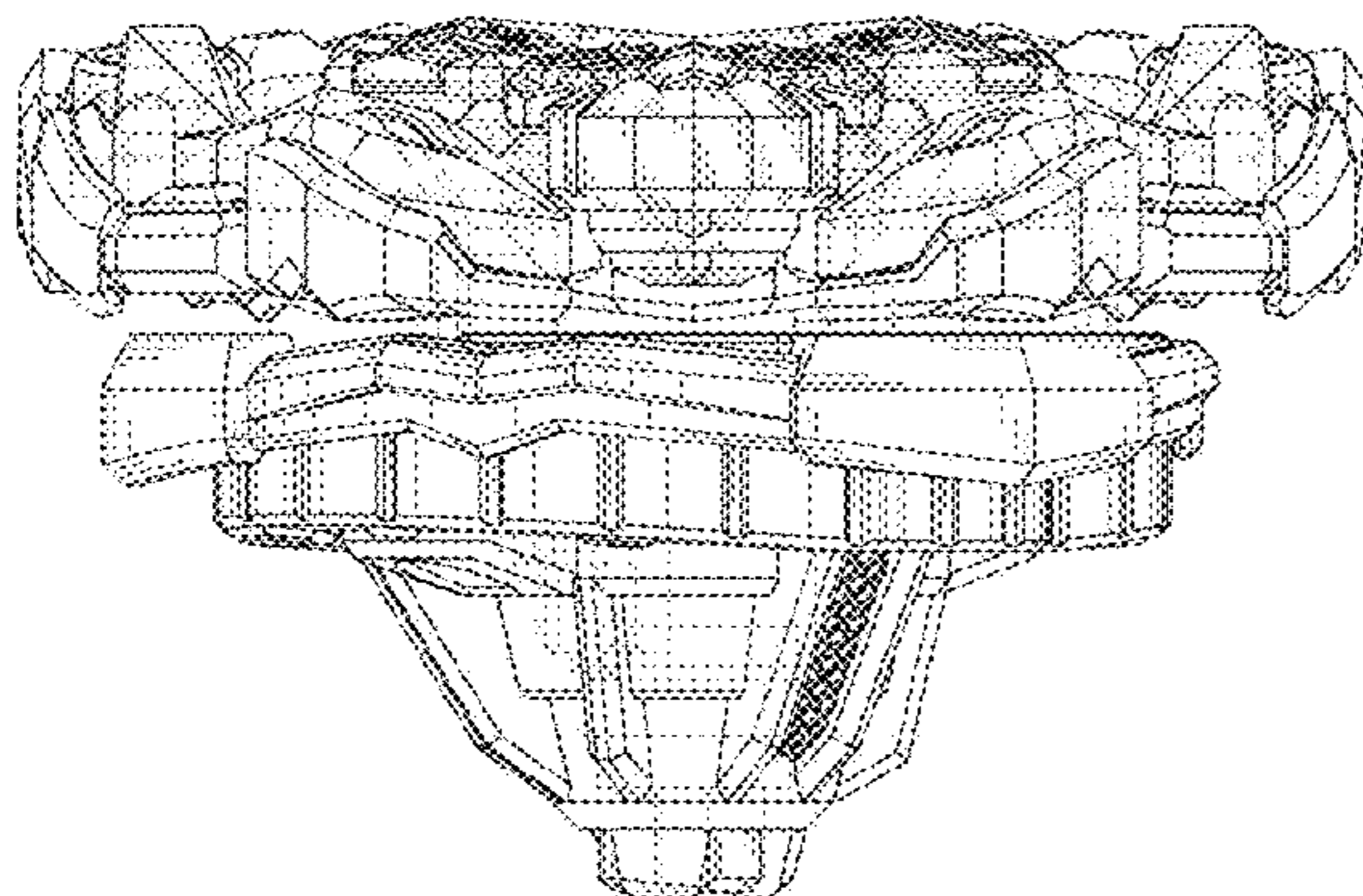

(58) **Field of Classification Search**

CPC ..... A63H 1/00-1/32; A63F 9/16  
See application file for complete search history.

(56) **References Cited**

U.S. PATENT DOCUMENTS

D629,468 S \* 12/2010 Ujita ..... D21/460  
D629,848 S \* 12/2010 Ujita ..... D21/460  
D646,729 S \* 10/2011 Ujita ..... D21/460  
D666,253 S \* 8/2012 Ujita ..... D21/460  
9,802,134 B2 \* 10/2017 Cai ..... A63H 1/02  
9,849,393 B2 \* 12/2017 Muraki ..... A63H 1/00  
9,849,395 B1 \* 12/2017 Muraki ..... A63H 1/02  
9,914,061 B2 \* 3/2018 Cai ..... A63H 33/26  
D834,101 S \* 11/2018 Horikoshi ..... D21/460  
D834,102 S \* 11/2018 Muraki ..... D21/460

FOREIGN PATENT DOCUMENTS

CN 302300475 \* 1/2013  
CN 303404375 \* 10/2015  
CN 303533297 \* 12/2015  
EM 001930363-0001 \* 1/2012  
EM 003253442-0004 \* 7/2016  
JP D1549750 \* 5/2016  
JP D1557219 \* 8/2016

\* cited by examiner

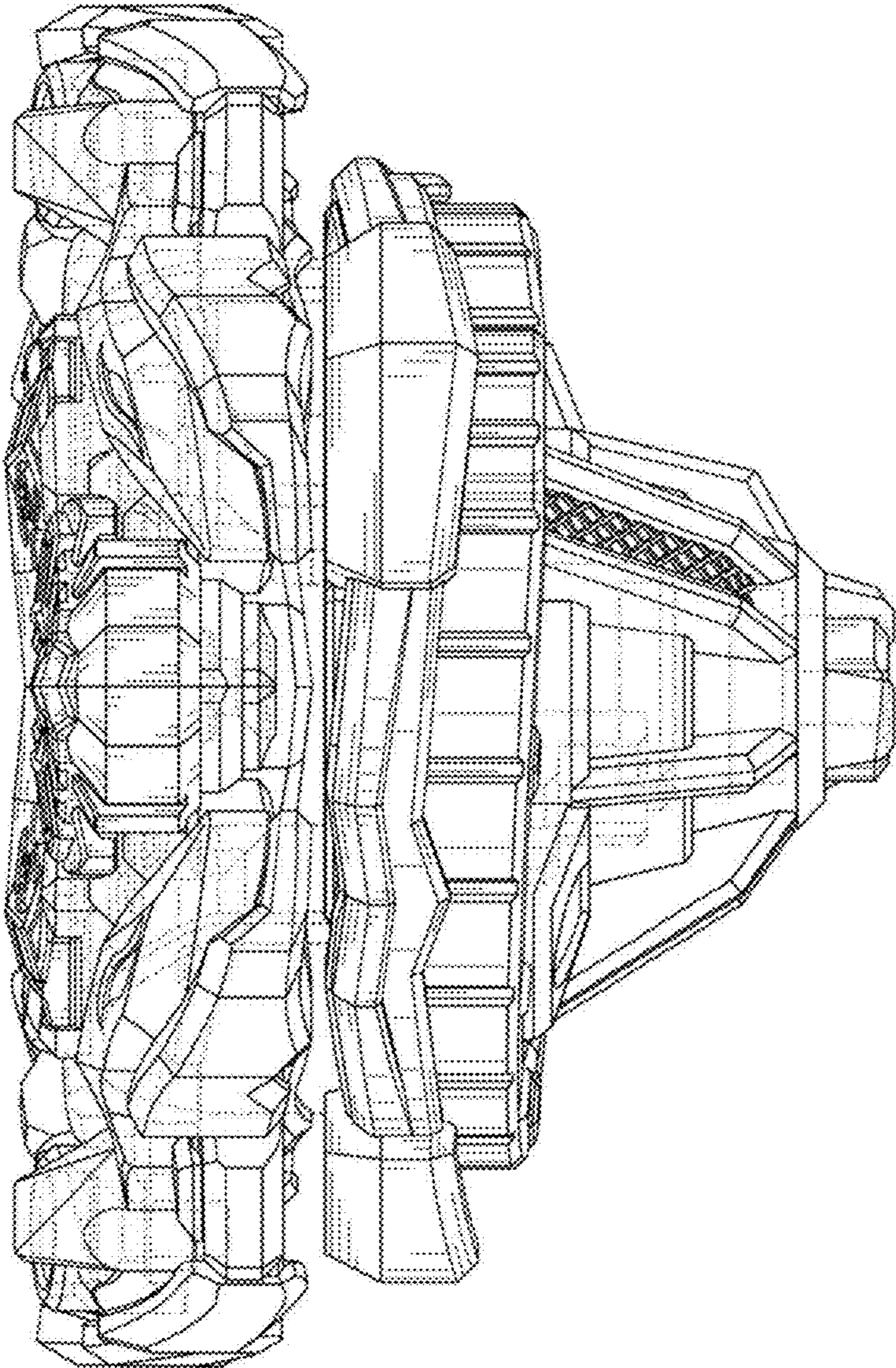

FIG. 1

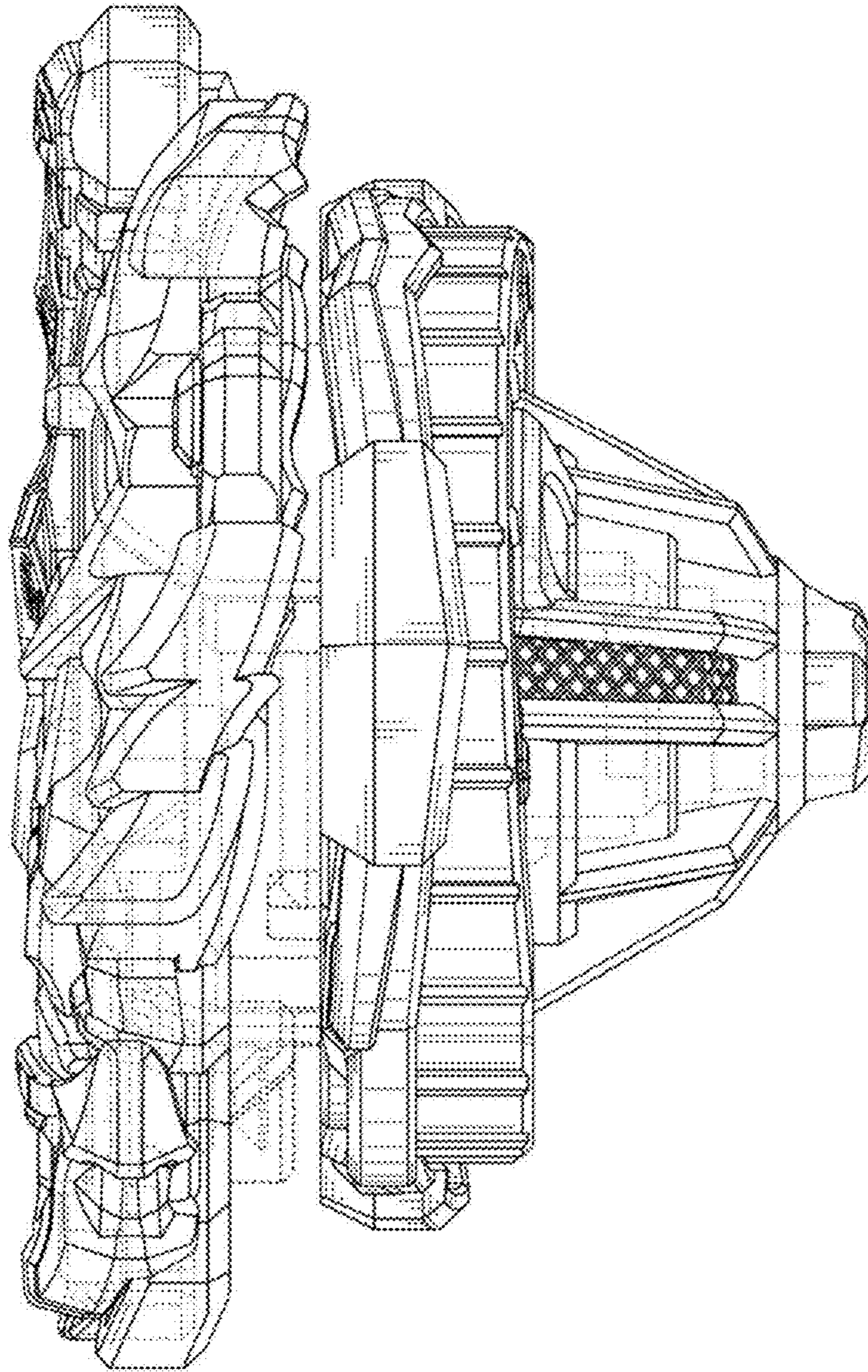

FIG. 2

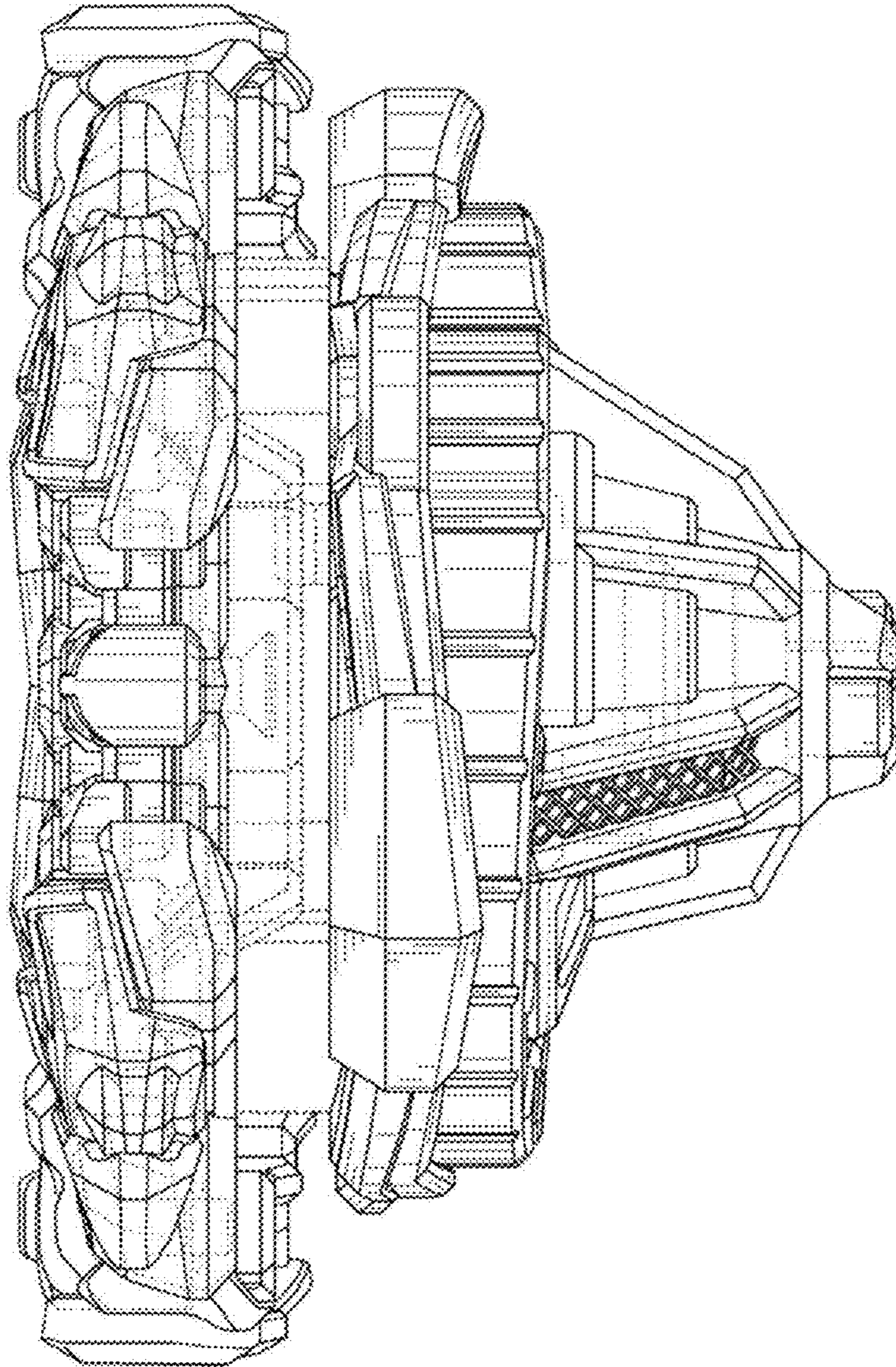

FIG. 3

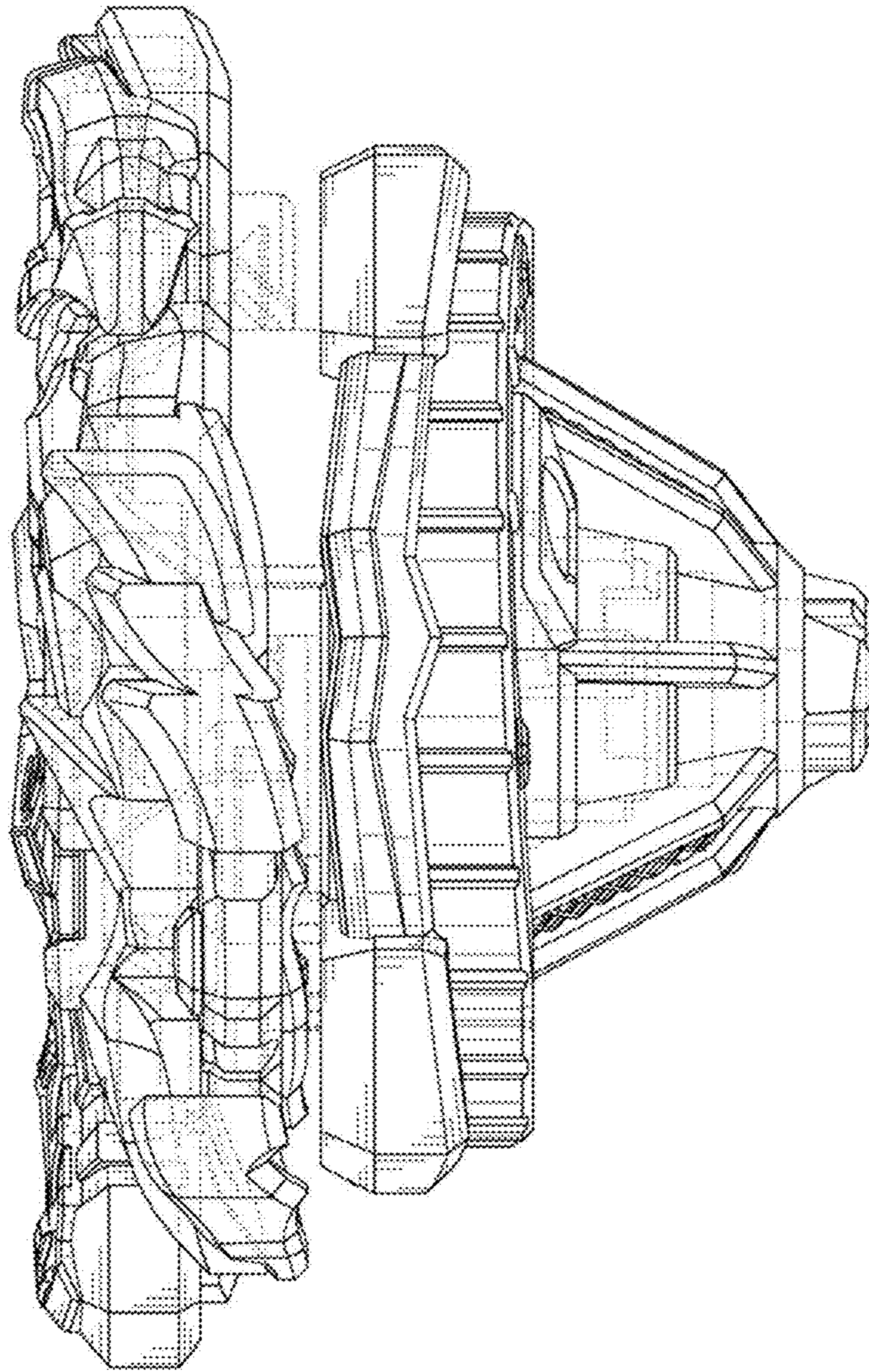

FIG. 4

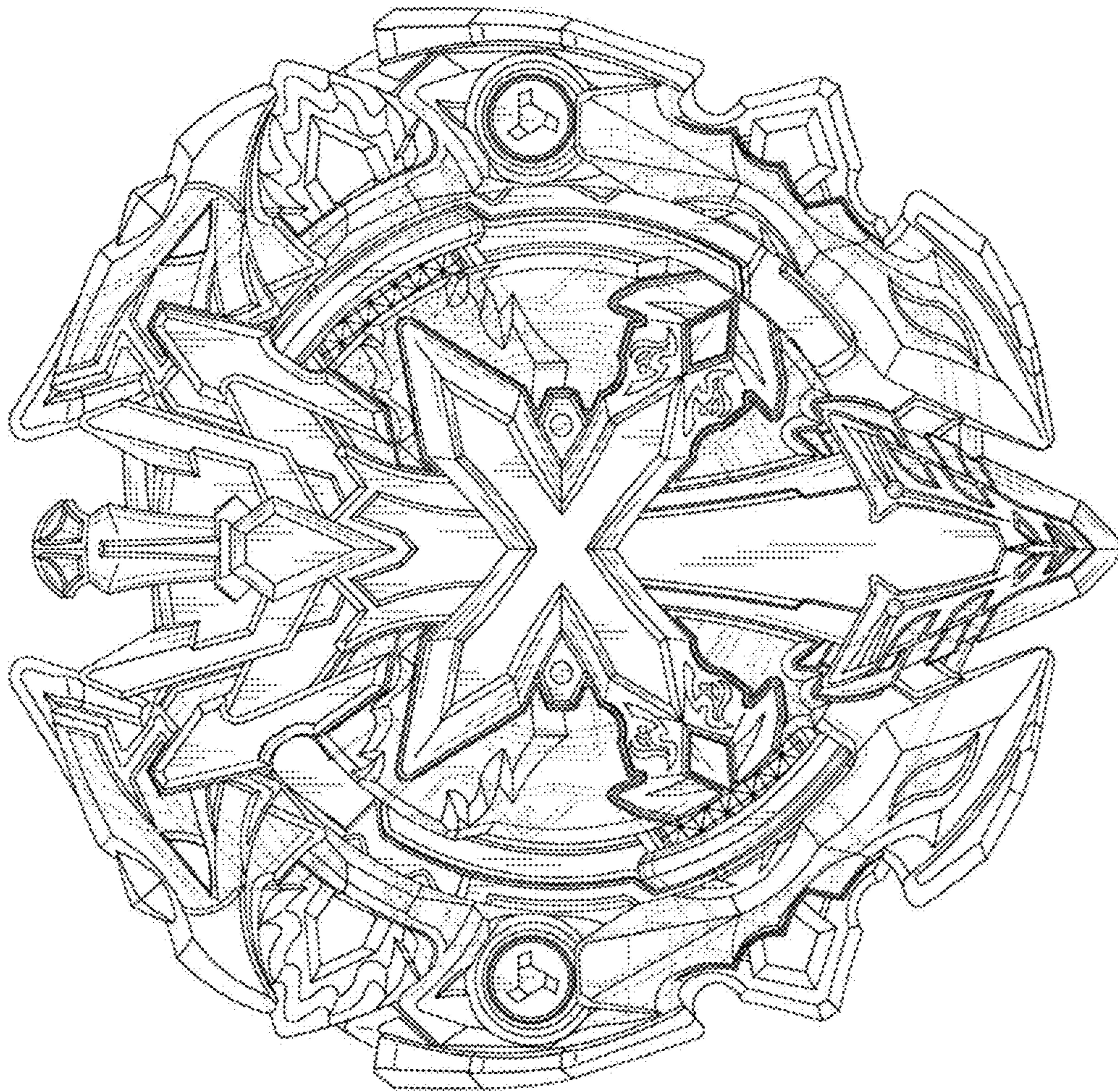

FIG. 5

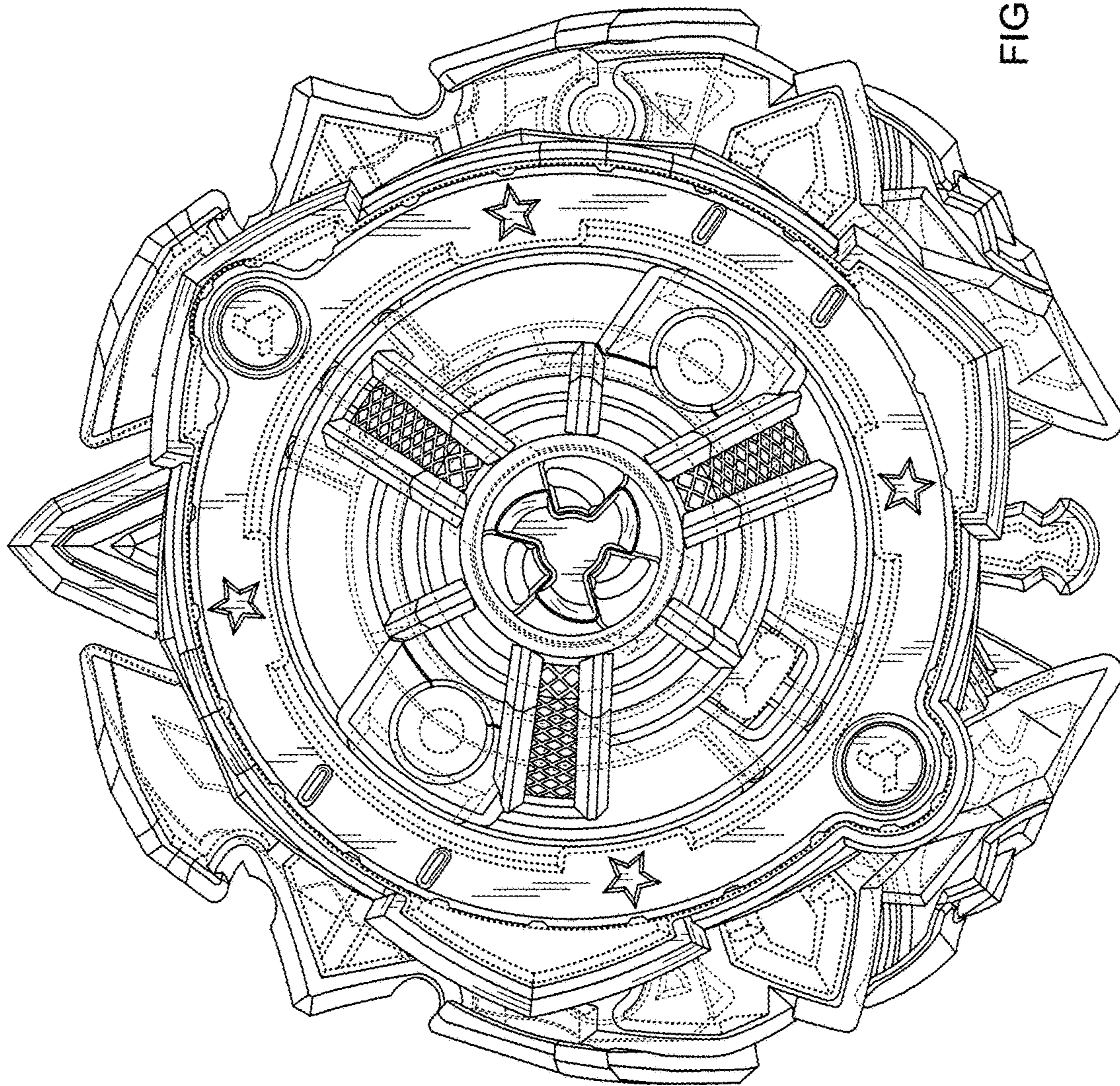

FIG. 6



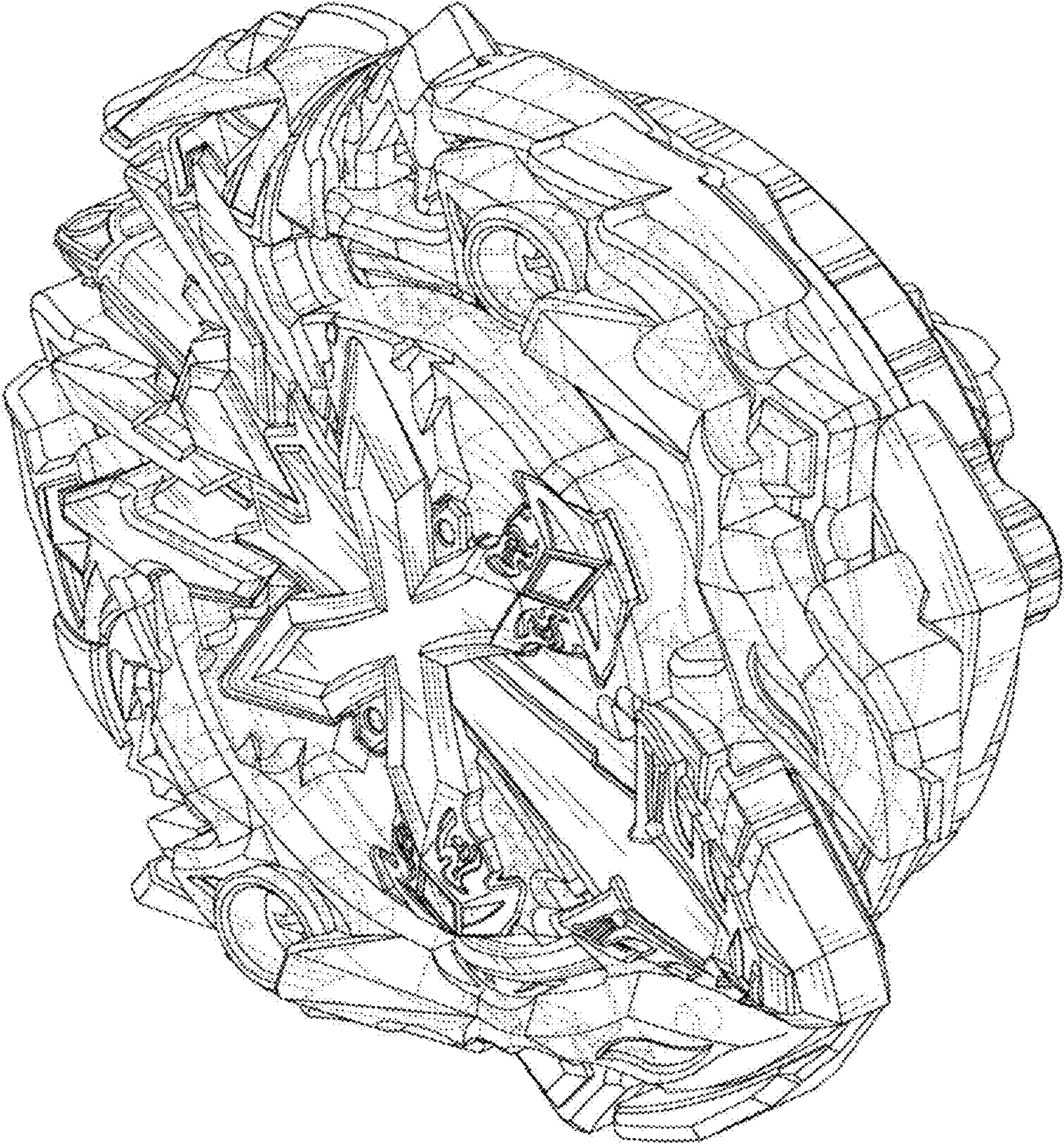

FIG. 7

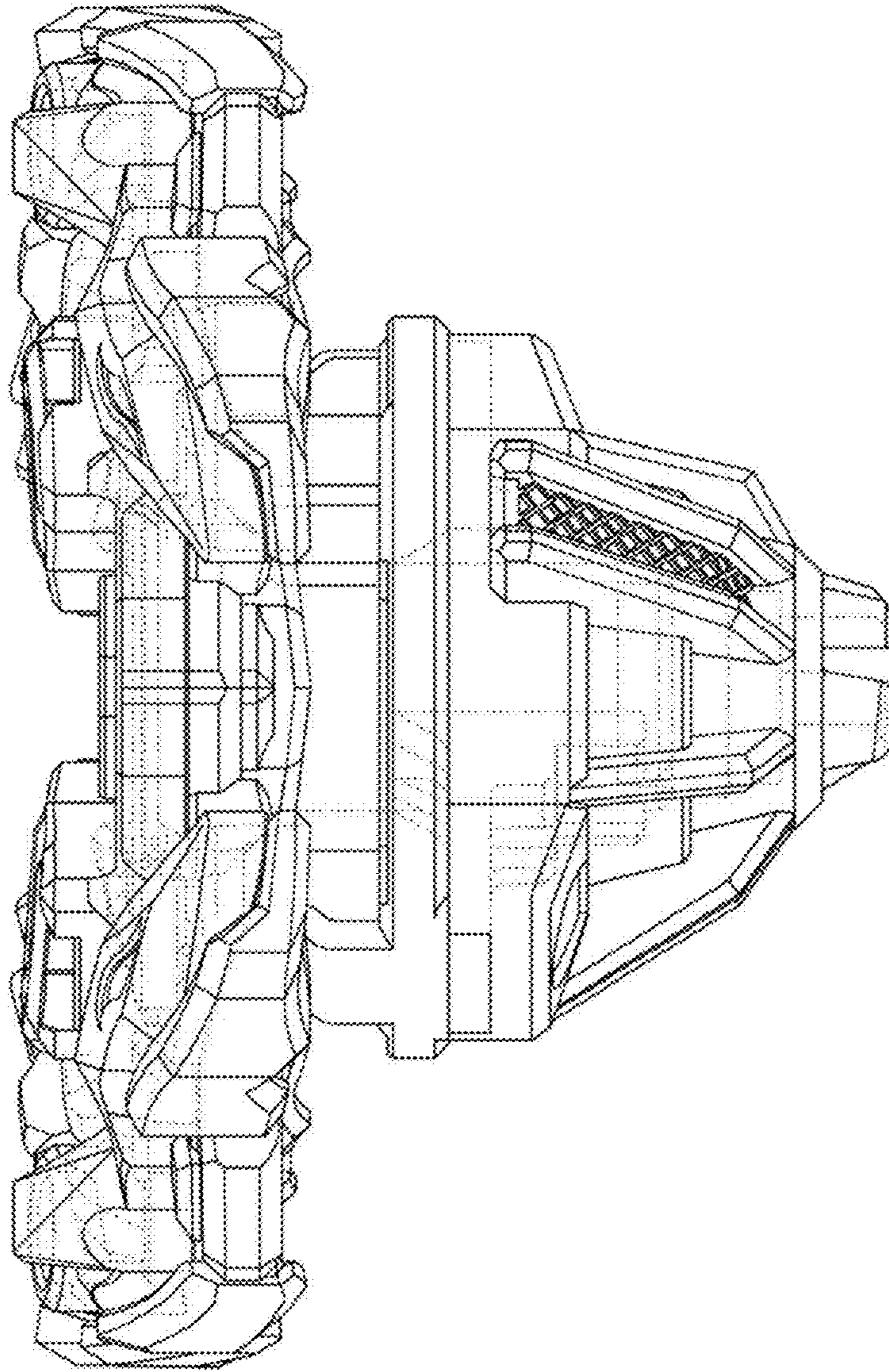

FIG. 8

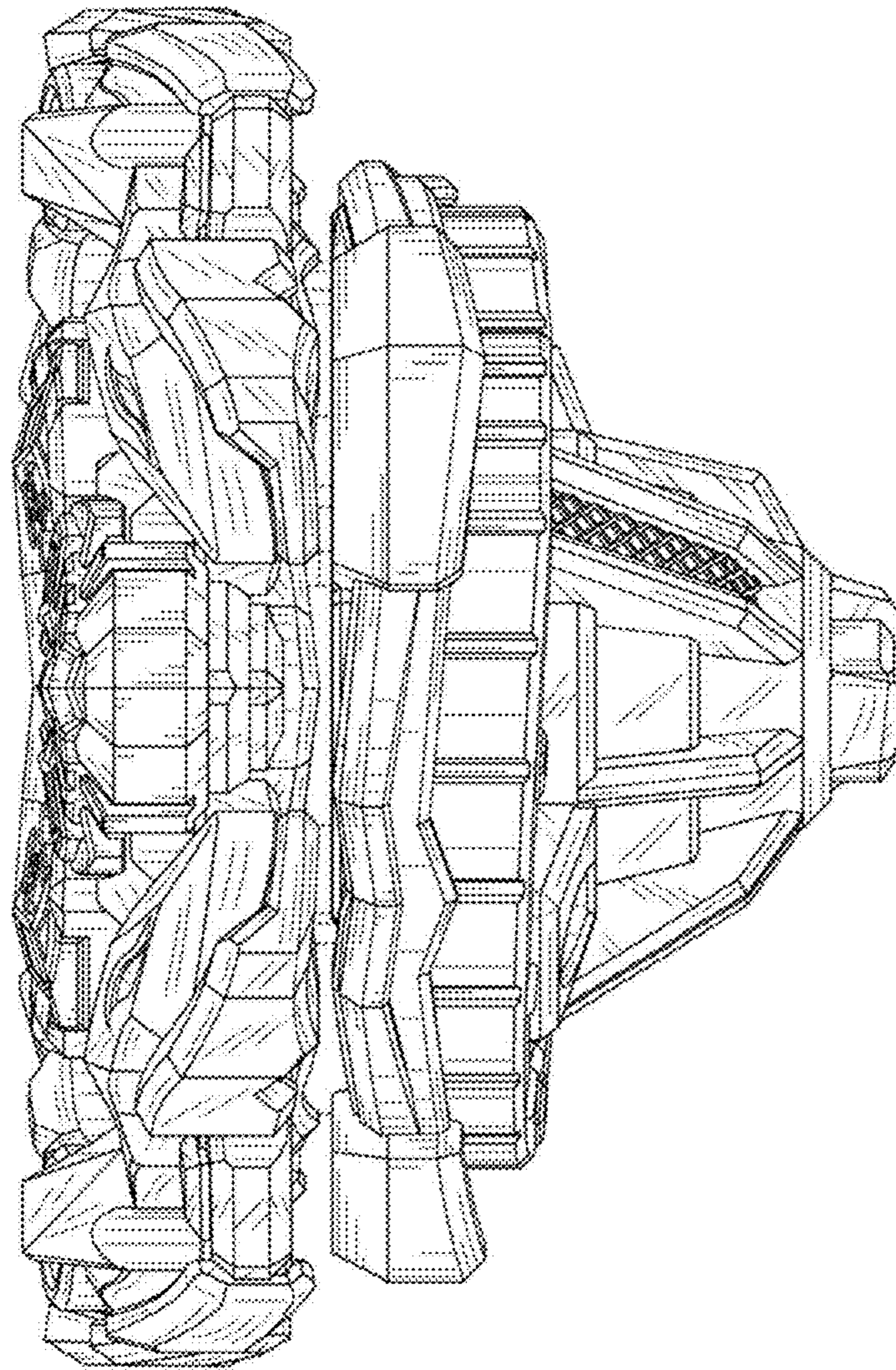

FIG. 9

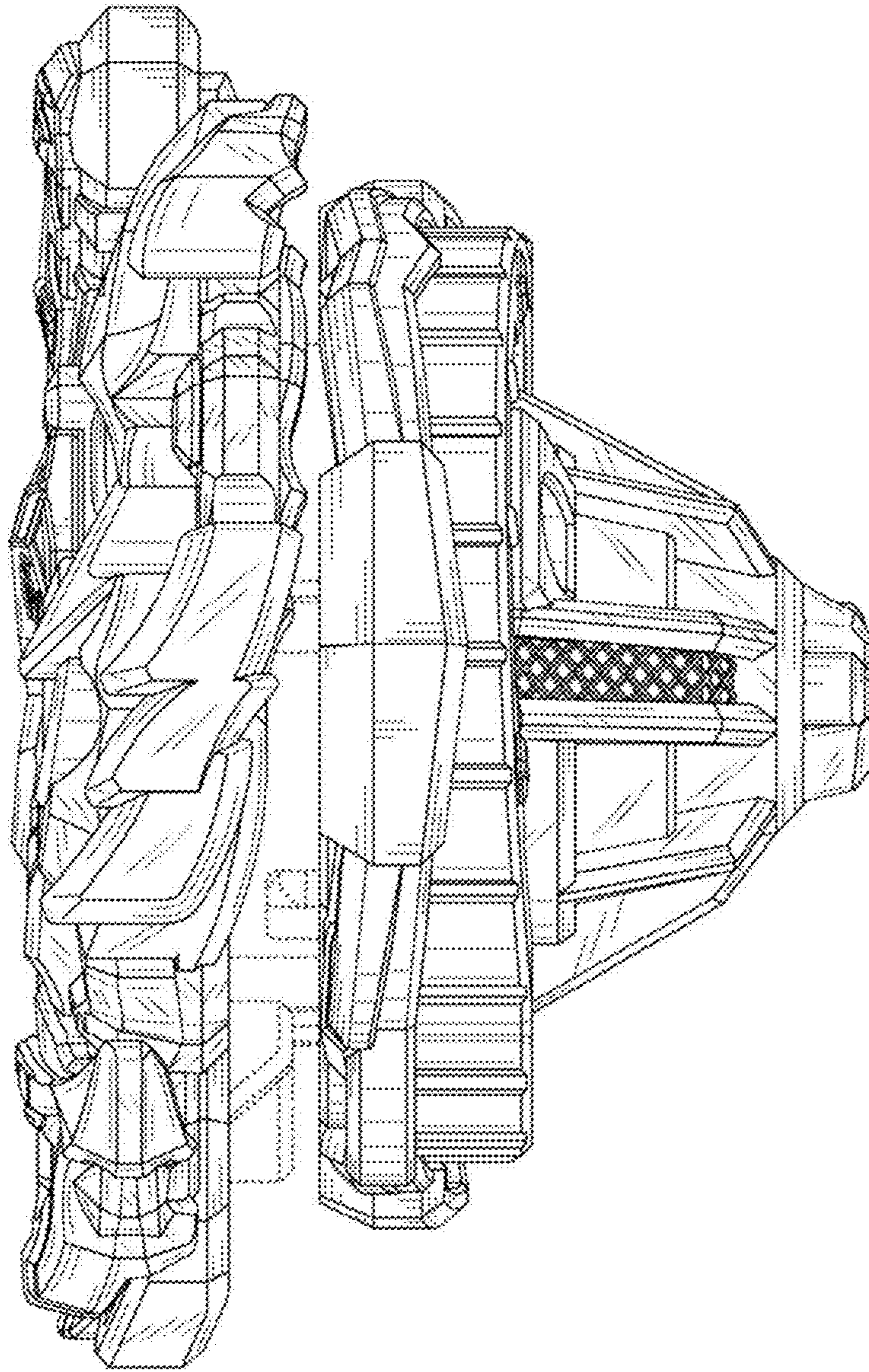

FIG. 10

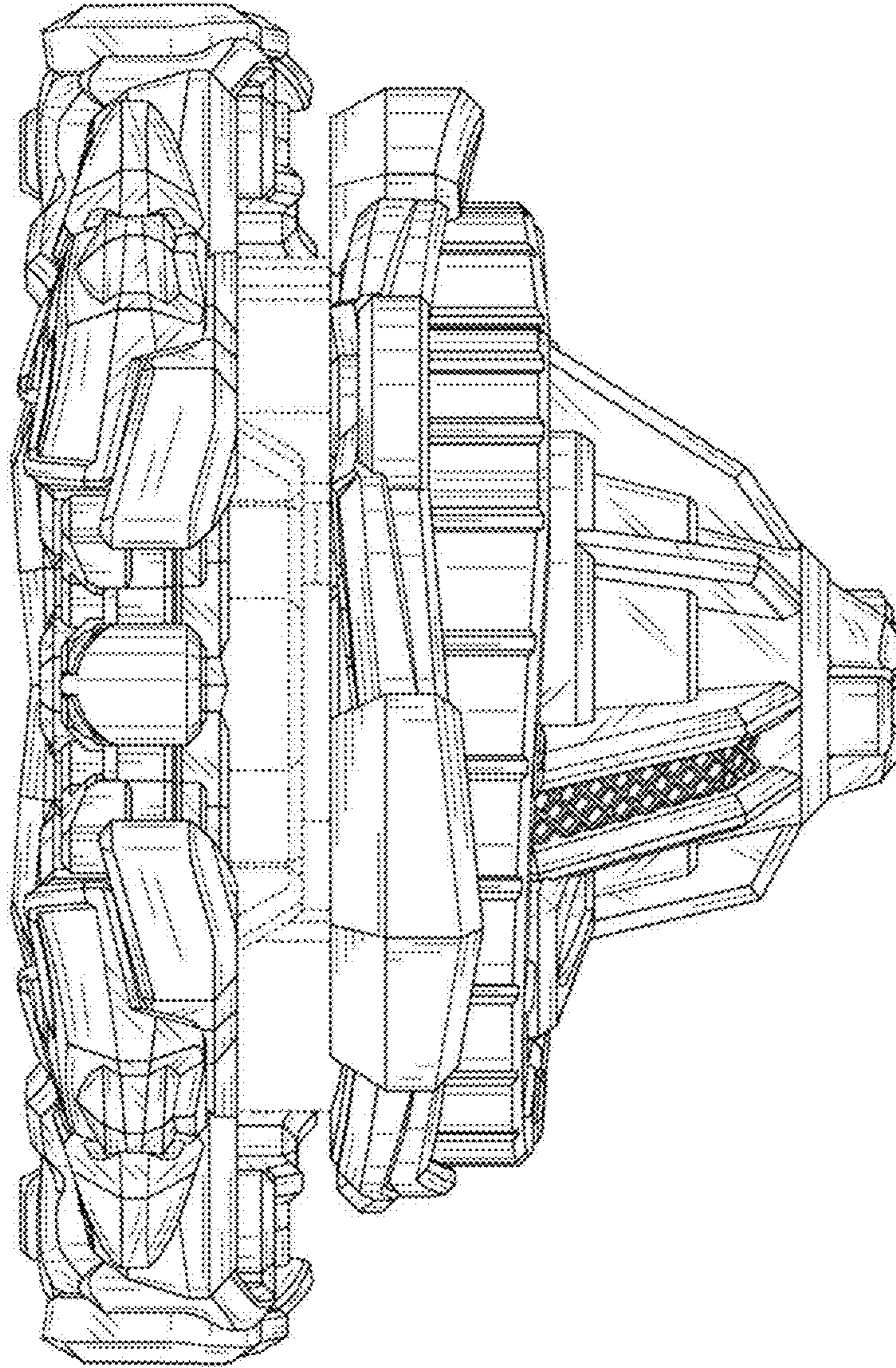

FIG. 11

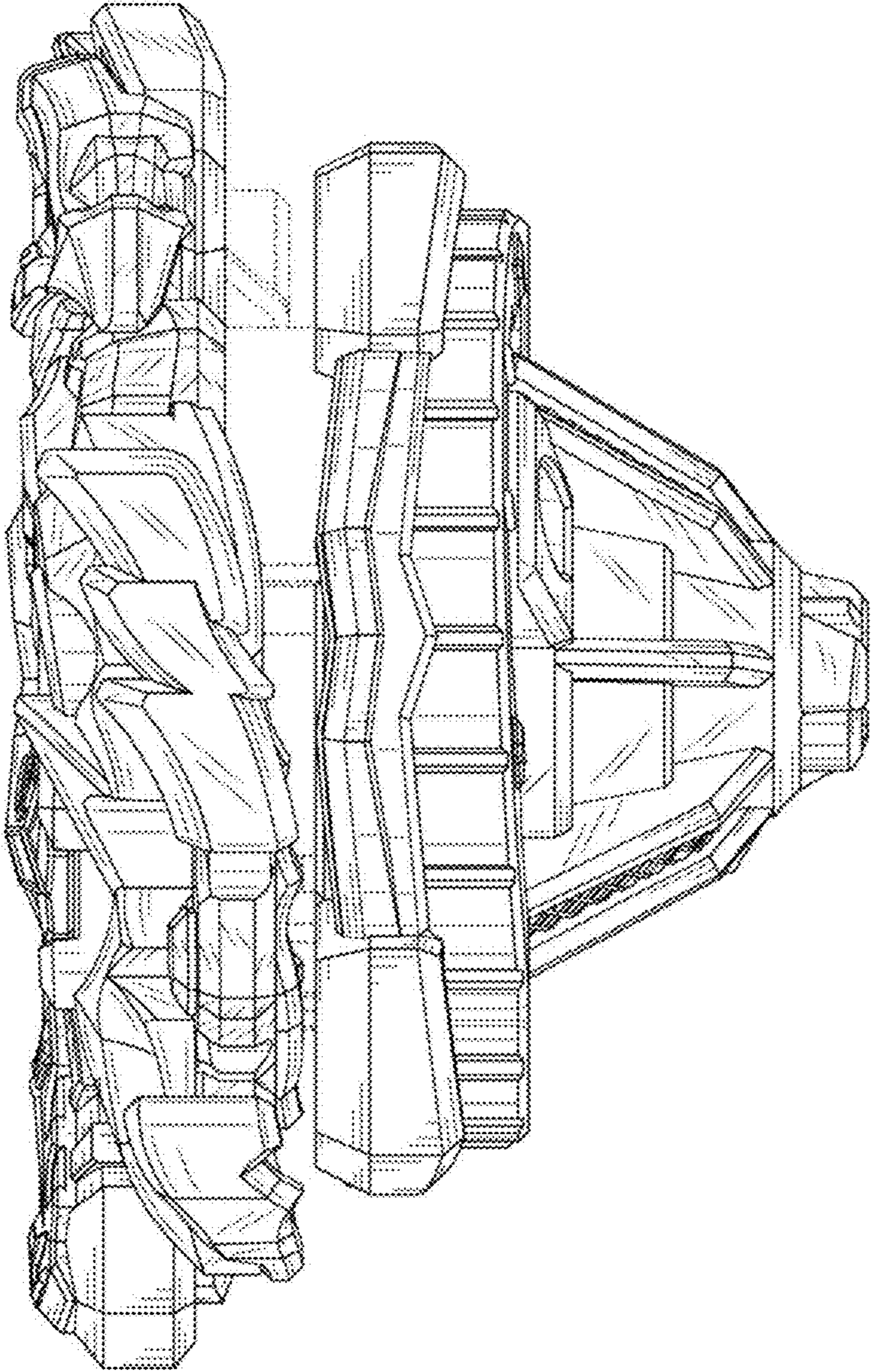

FIG. 12

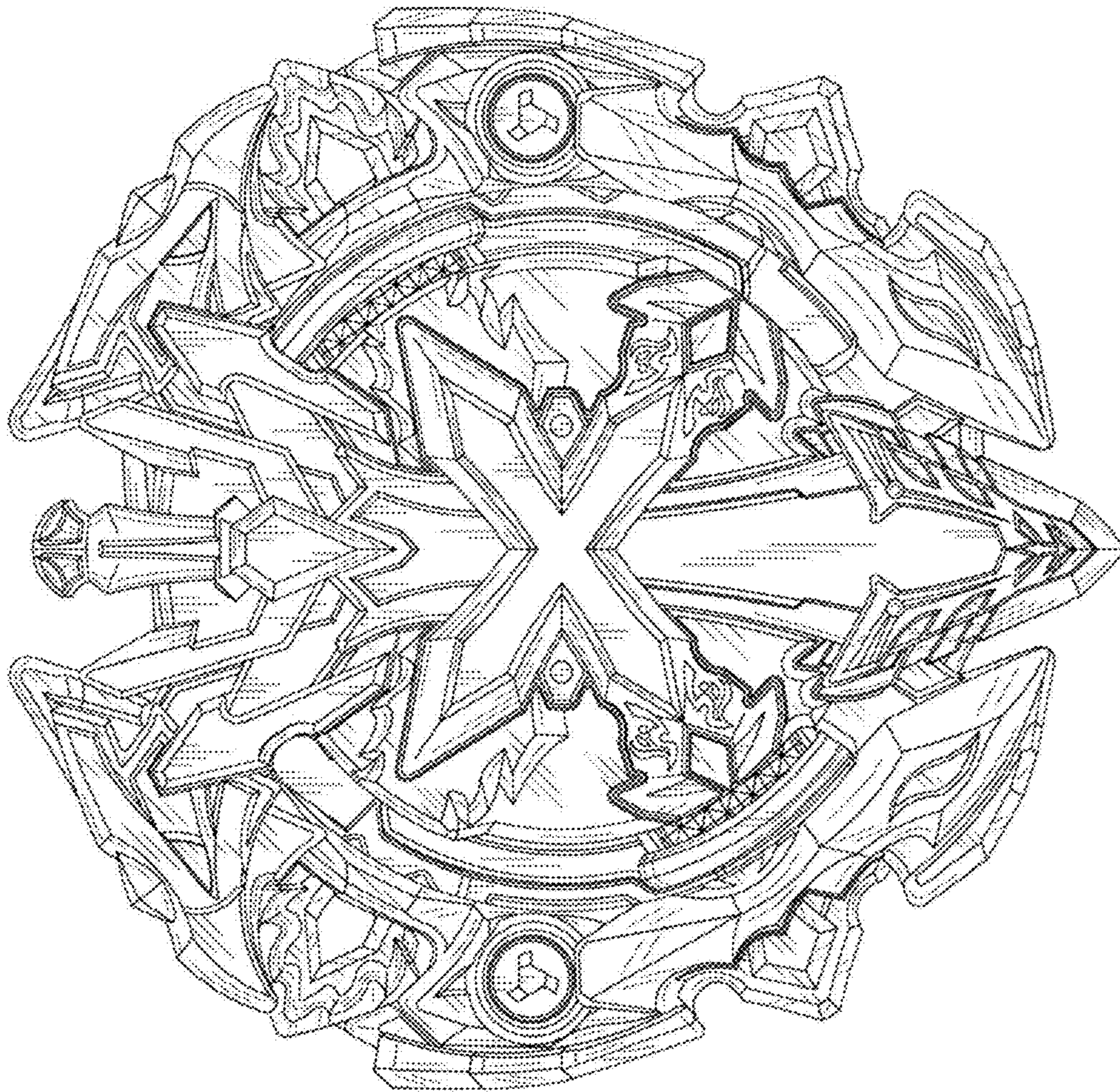

FIG. 13

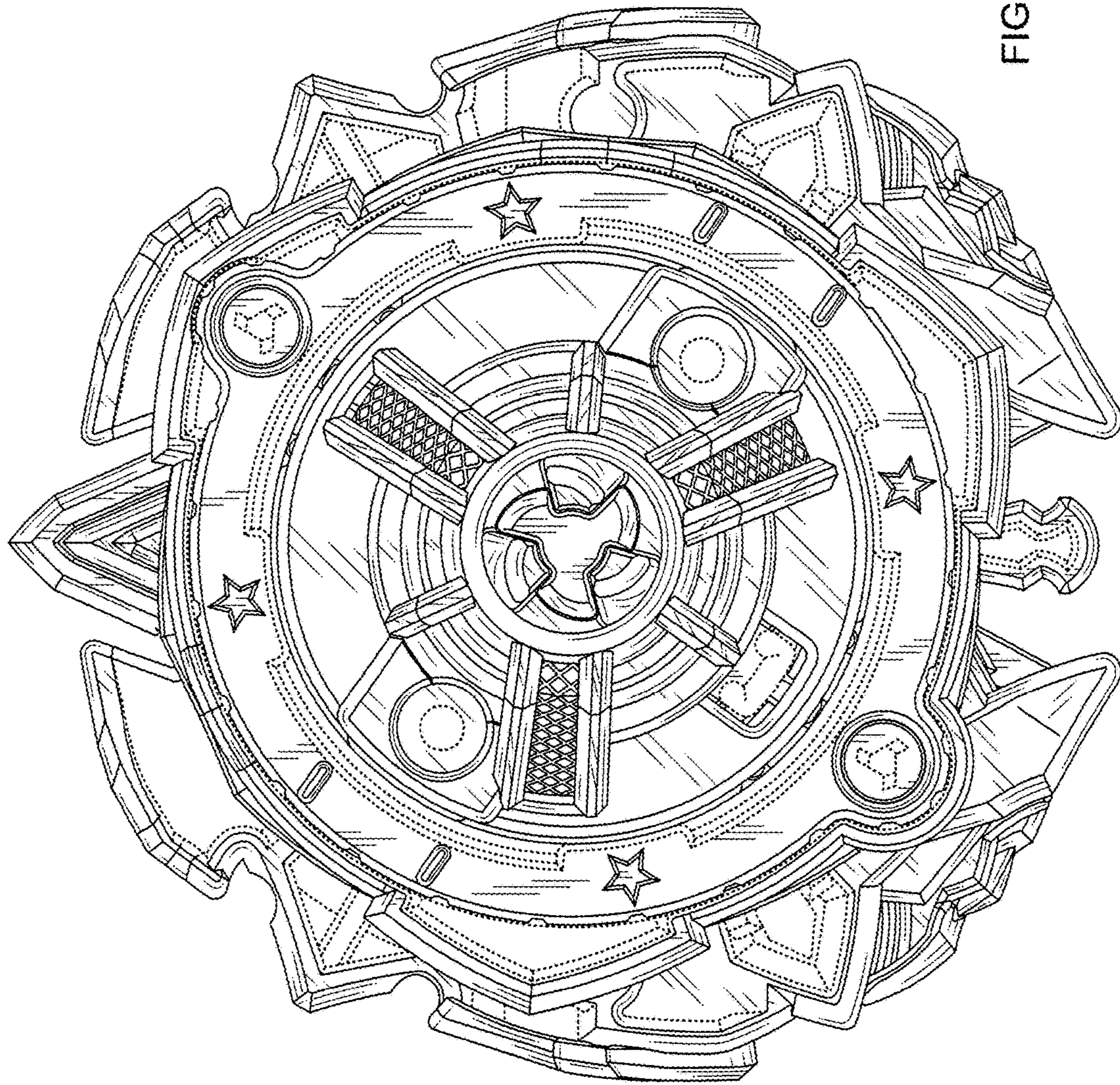

FIG. 14



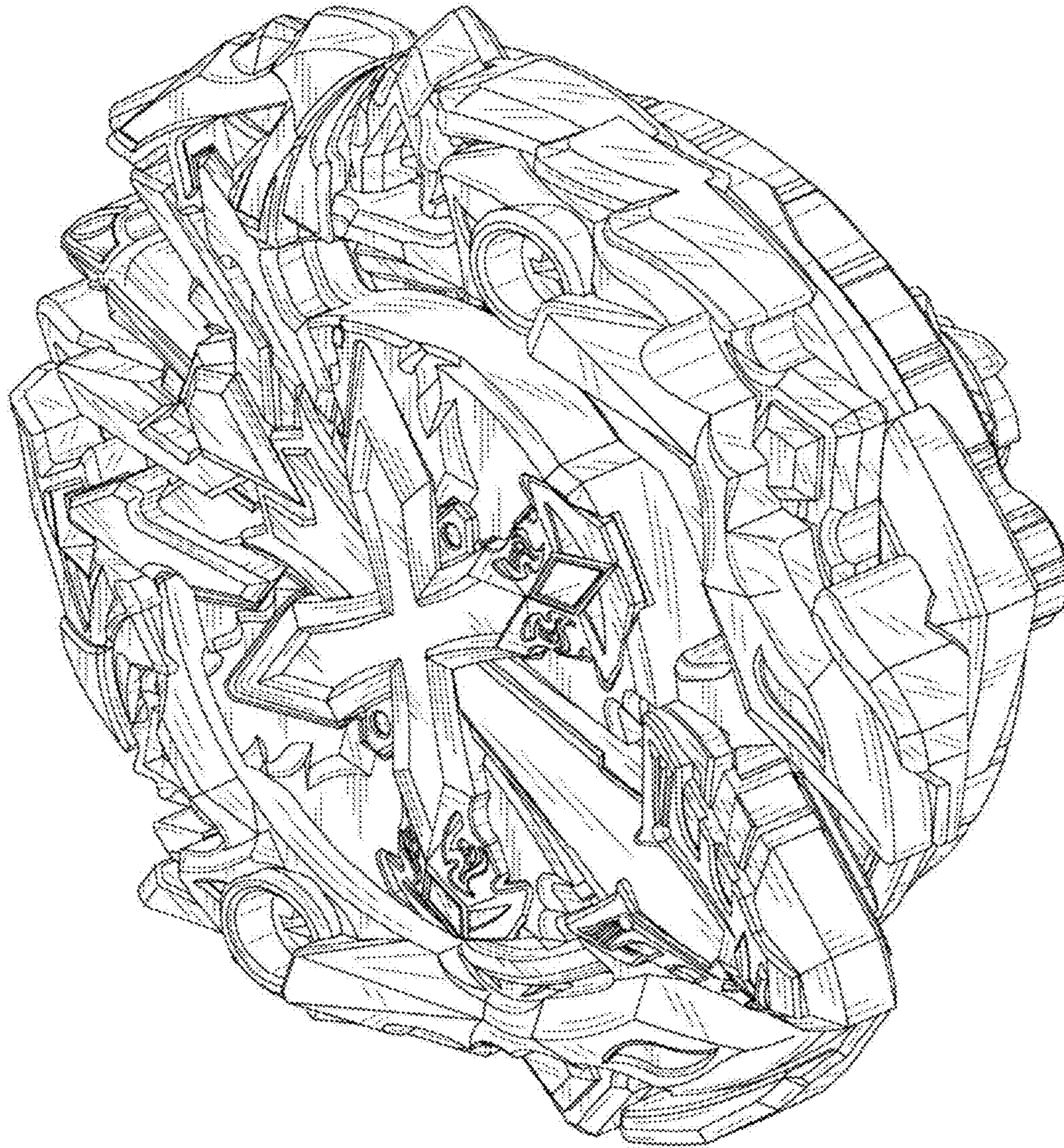

FIG. 15

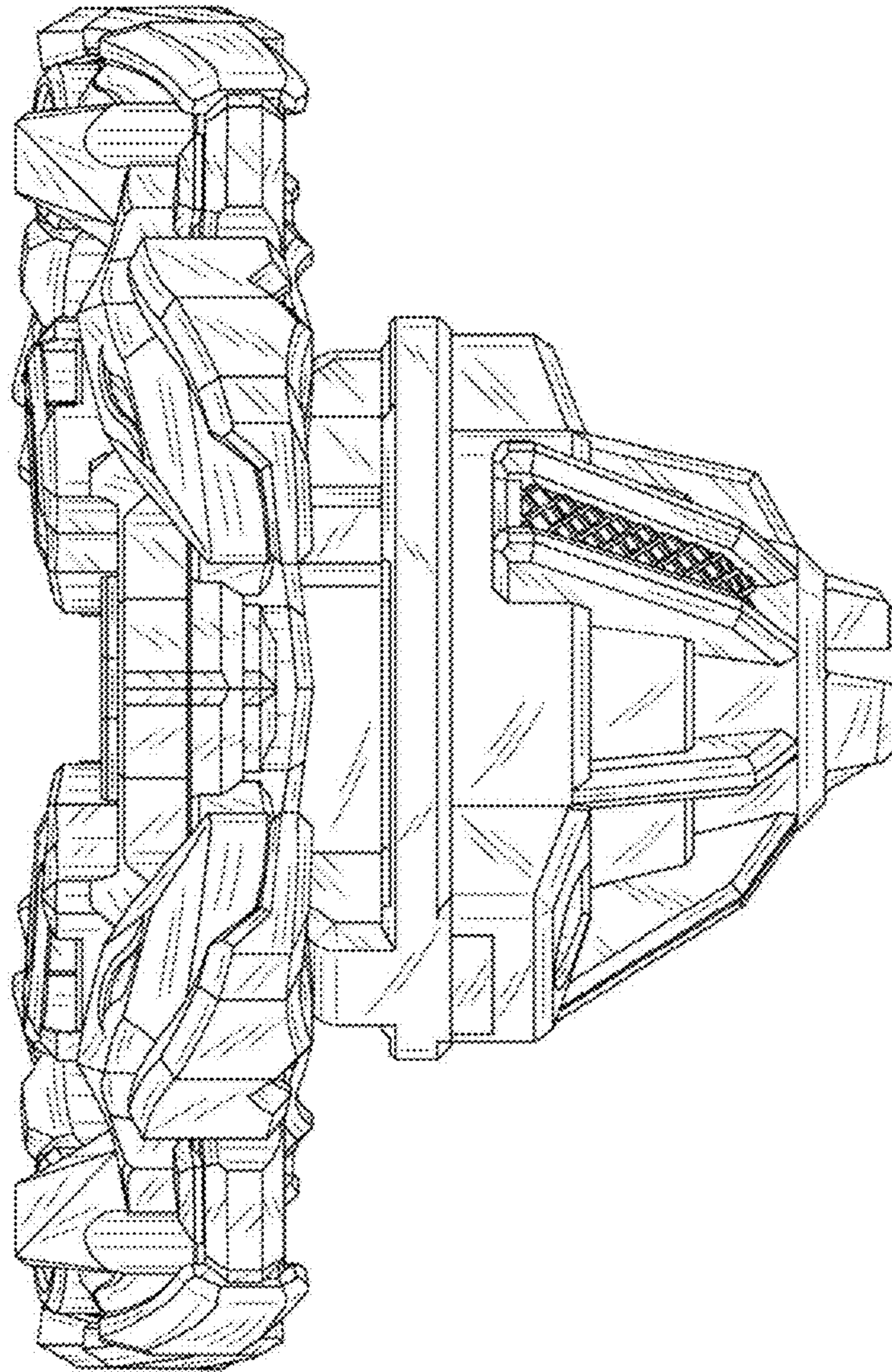

FIG. 16