



US00D846649S

(12) **United States Design Patent** (10) **Patent No.:** **US D846,649 S**
Schoonmaker et al. (45) **Date of Patent:** **** Apr. 23, 2019**

(54) **LIGHT BAR FOR GAMING MACHINE
TOPPER DISPLAY**

(71) Applicant: **Aristocrat Technologies Australia Pty
Limited**, North Ryde (AU)

(72) Inventors: **Rena Schoonmaker**, Las Vegas, NV
(US); **Dominic DeMarco**, Round Rock,
TX (US)

(73) Assignee: **ARISTOCRAT TECHNOLOGIES
AUSTRALIA PTY LIMITED (AU)**

(**) Term: **15 Years**

(21) Appl. No.: **29/619,823**

(22) Filed: **Oct. 2, 2017**

(51) **LOC (11) Cl.** **21-03**

(52) **U.S. Cl.**
USPC **D21/369**

(58) **Field of Classification Search**
USPC 463/1, 28, 29, 30, 31, 32, 33, 34, 35, 46,
463/47; D14/125, 126, 133, 203.7, 203.8,
D14/217, 300, 301, 302, 305; D21/324,
D21/325, 329, 369, 370, 371; 361/826;
211/26; 52/28, 204.1; 248/906; D25/60,
D25/61; D8/349; D6/300-314; D20/10;
D10/24
CPC ... G07F 17/32; G07F 17/3202; G07F 17/3209
See application file for complete search history.

(56) **References Cited**

U.S. PATENT DOCUMENTS

3,780,286	A *	12/1973	Alexieff	F21S 8/02 362/235
D295,193	S *	4/1988	Visocky	D20/10
D372,314	S *	7/1996	Delman	D25/136
D391,773	S *	3/1998	Zaidman	D6/301
D392,468	S *	3/1998	O'Reilly	D6/300

D405,976	S *	2/1999	Beall	D20/10
D411,582	S *	6/1999	Muraki	D21/325
D503,435	S *	3/2005	Morrison	D21/370
D503,436	S *	3/2005	Morrison	D21/370
D510,959	S *	10/2005	Morrison	D21/370
D523,249	S *	6/2006	Hoernig	D6/300
D544,922	S *	6/2007	Shaffer	D20/10
D572,024	S *	7/2008	Shapiro	D6/301
D594,510	S *	6/2009	Sappington	D20/10
D602,996	S *	10/2009	Takeuchi	D21/385
D613,338	S *	4/2010	Marukos	D20/10
D636,187	S *	4/2011	Kim	D6/308

(Continued)

Primary Examiner — Cynthia Ramirez

Assistant Examiner — Michael A Maharajh

(74) *Attorney, Agent, or Firm* — McAndrews, Held &
Malloy, Ltd.

(57) **CLAIM**

The ornamental design for a light bar for gaming machine
topper display, as shown and described.

DESCRIPTION

FIG. 1 is a front perspective view of a light bar for gaming
machine topper display showing our new design;
FIG. 2 is a front elevation view thereof;
FIG. 3 is a rear elevation view thereof;
FIG. 4 is a right side elevation view thereof;
FIG. 5 is a left side elevation view thereof;
FIG. 6 is a top plan view thereof;
FIG. 7 is a bottom plan view thereof; and,
FIG. 8 is another front elevation view showing our new
design in an illuminated state.
The dashed broken lines in the drawings illustrate portions
of the light bar for gaming machine topper display that form
no part of the claimed design.
The radiating lines in FIG. 8 represents the glowing visual
effect created by light emanating from the light ring sur-
rounding the upper displays of the gaming machine.

1 Claim, 6 Drawing Sheets

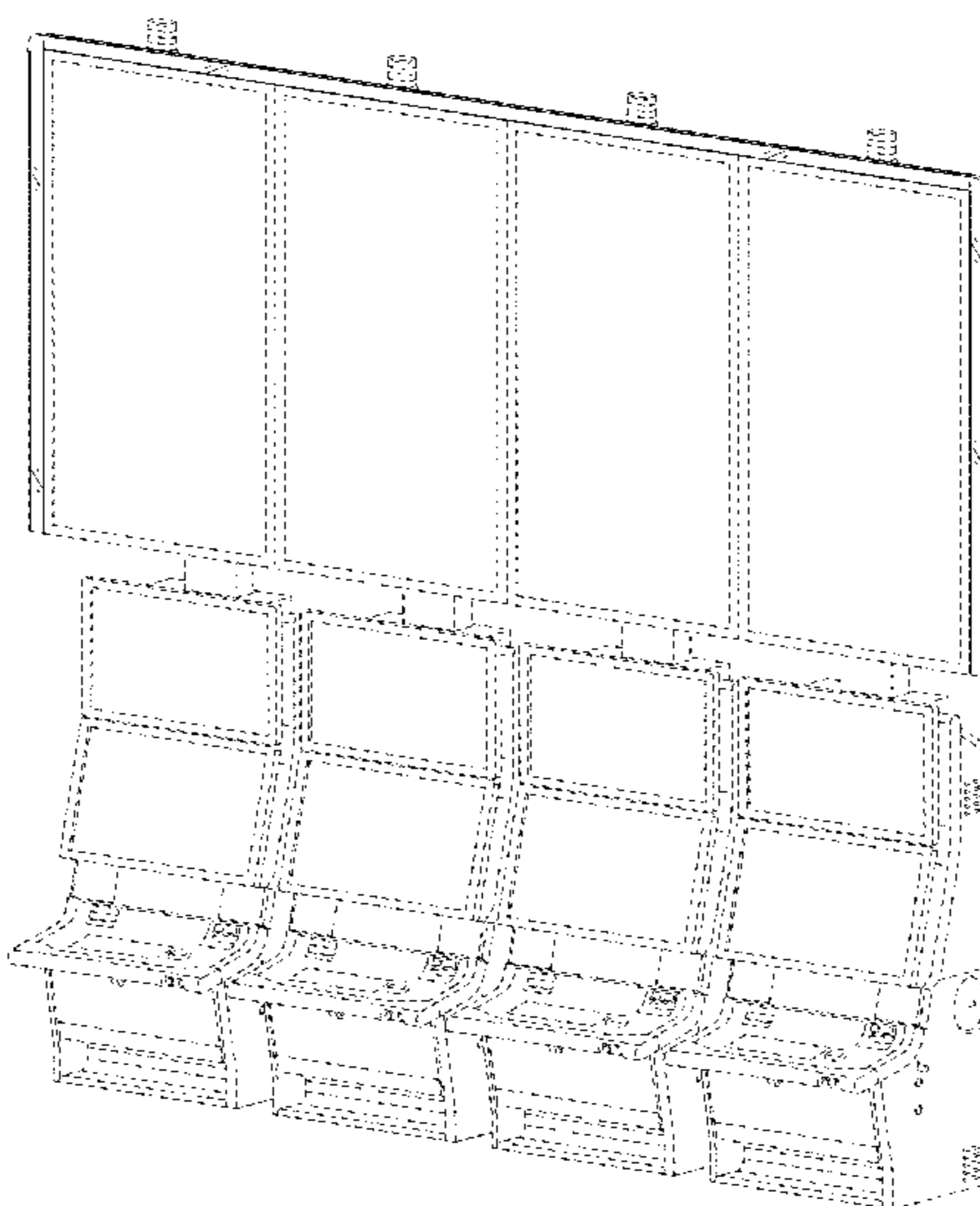

(56)

References Cited

U.S. PATENT DOCUMENTS

D636,188	S *	4/2011	Kim	D6/308
D639,568	S *	6/2011	Lee	D6/308
D642,385	S *	8/2011	Lee	D6/308
D676,430	S *	2/2013	Blaser	D14/239
8,382,572	B2 *	2/2013	Hoffman	G07F 17/3272
				463/20
8,491,385	B2 *	7/2013	Miodunski	G07F 17/3211
				463/31
D732,113	S *	6/2015	Estep, II	D21/329
D732,114	S *	6/2015	Estep, II	D21/329
D740,571	S *	10/2015	Gorham	D6/300
D740,888	S *	10/2015	DePalma	D21/370
D790,232	S *	6/2017	Santos	D6/300
D806,690	S *	1/2018	Schimon	D14/239
10,013,061	B2 *	7/2018	Froy	G06F 3/016
10,013,845	B2 *	7/2018	Froy, Jr.	G07F 17/3211
D832,356	S *	10/2018	Castro	D21/369
2018/0040203	A1 *	2/2018	Winters	G07F 17/3295
2018/0082545	A1 *	3/2018	Winters	G07F 17/3295

* cited by examiner

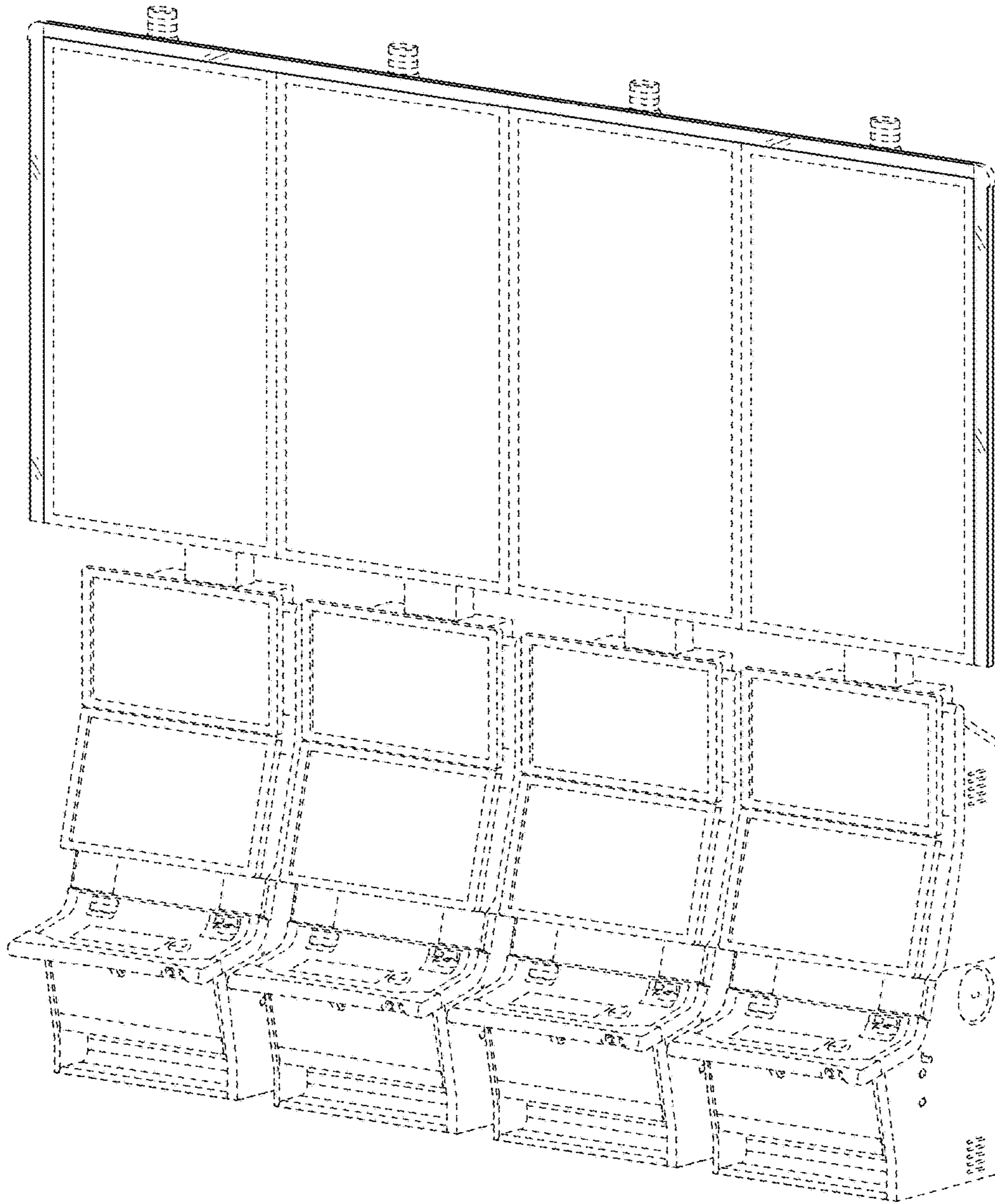

FIG. 1

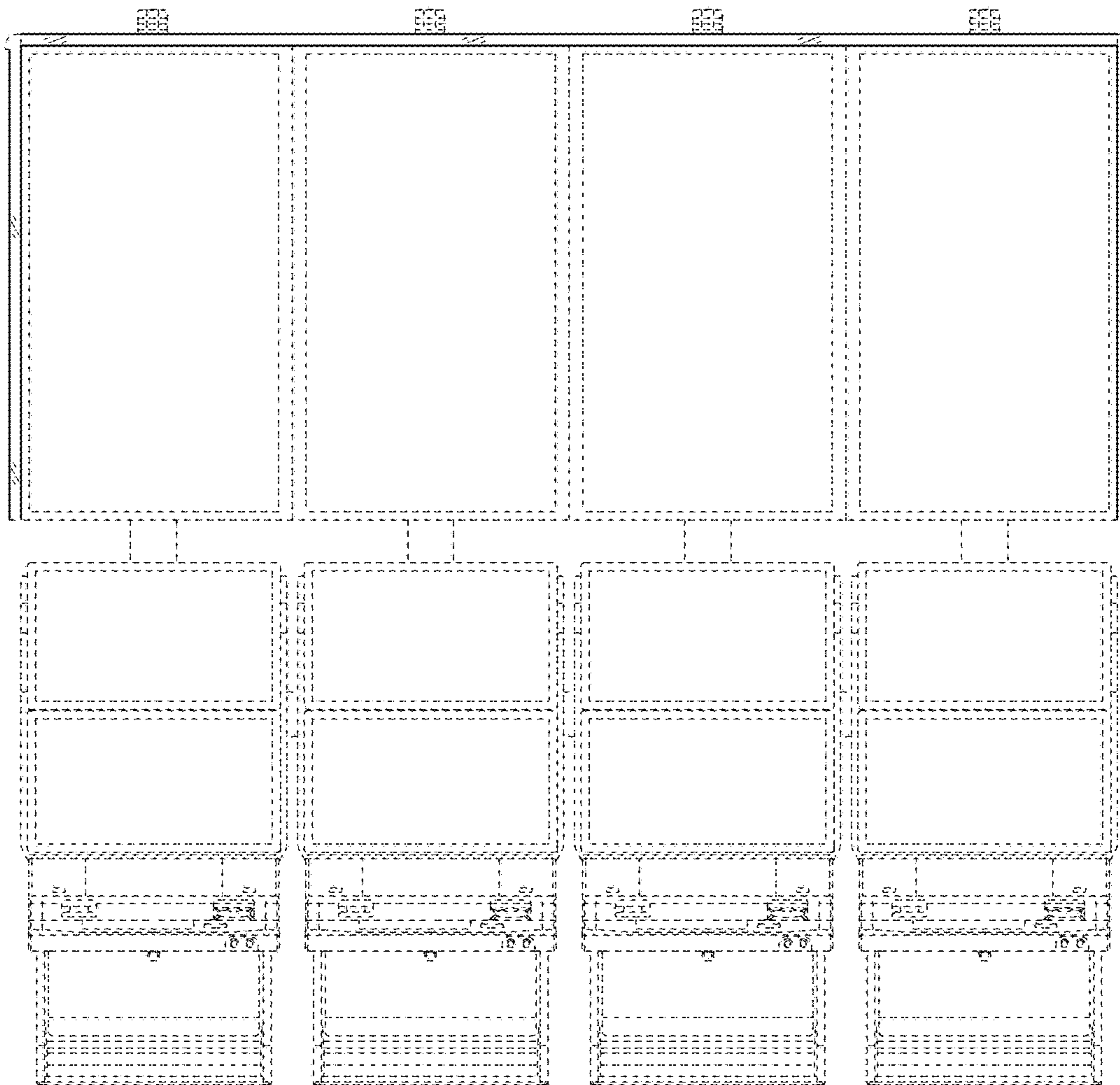

FIG. 2

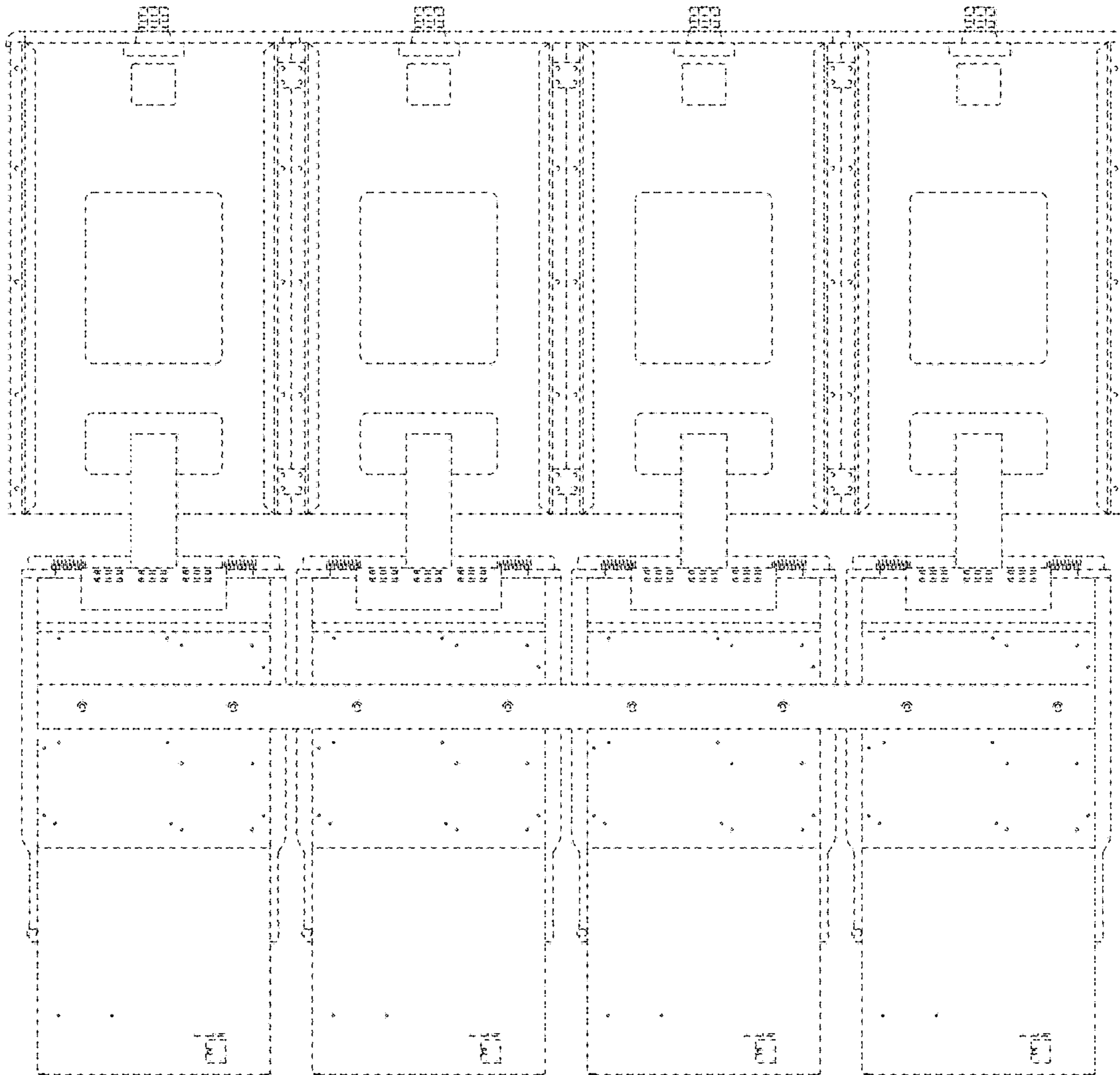

FIG. 3

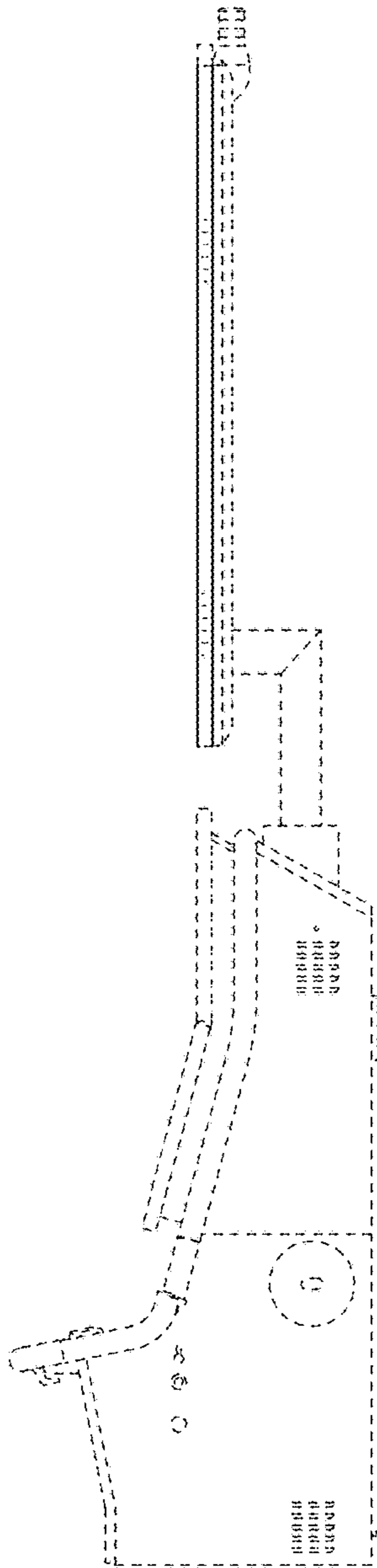

FIG. 4

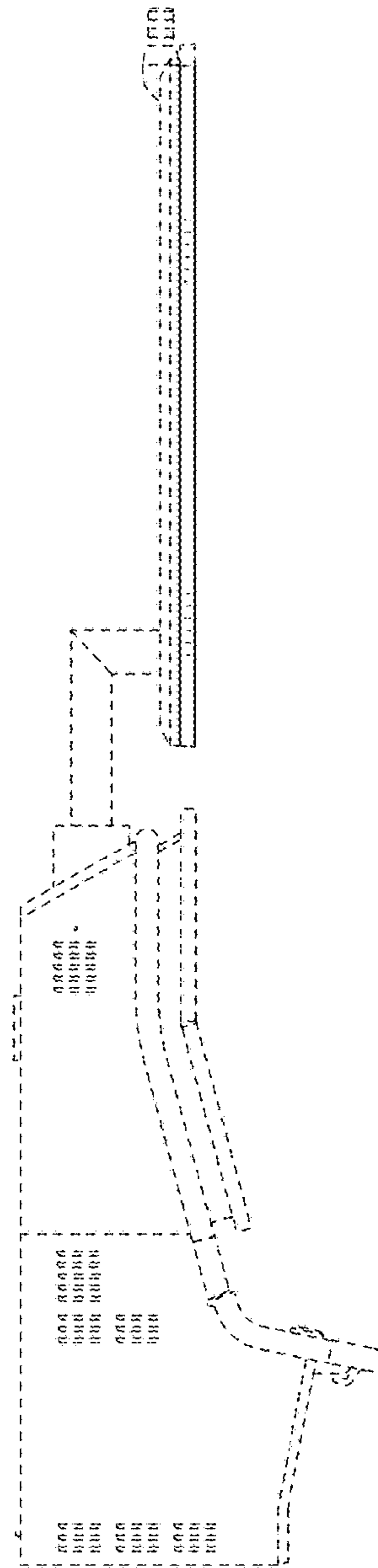

FIG. 5

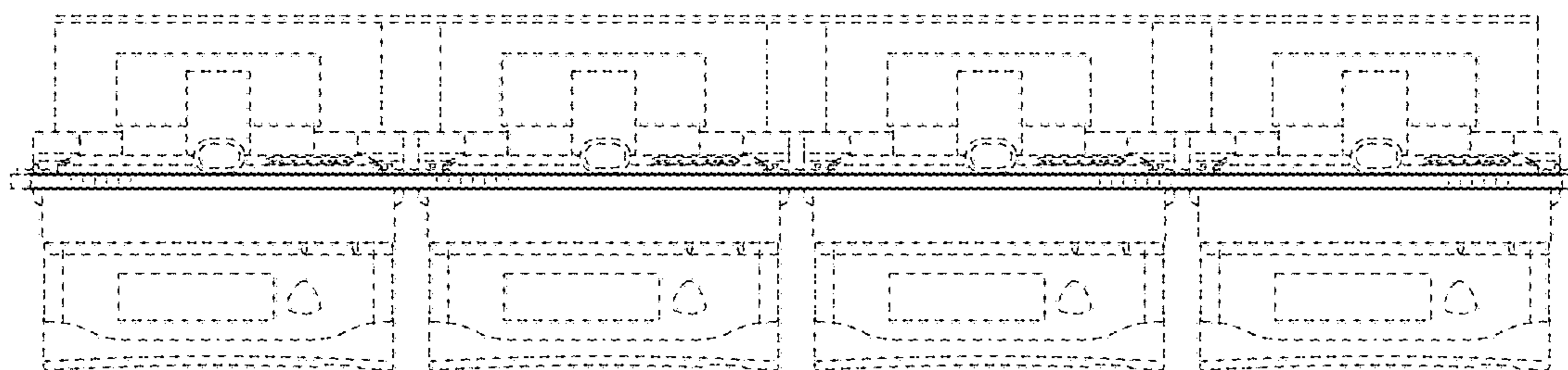

FIG. 6

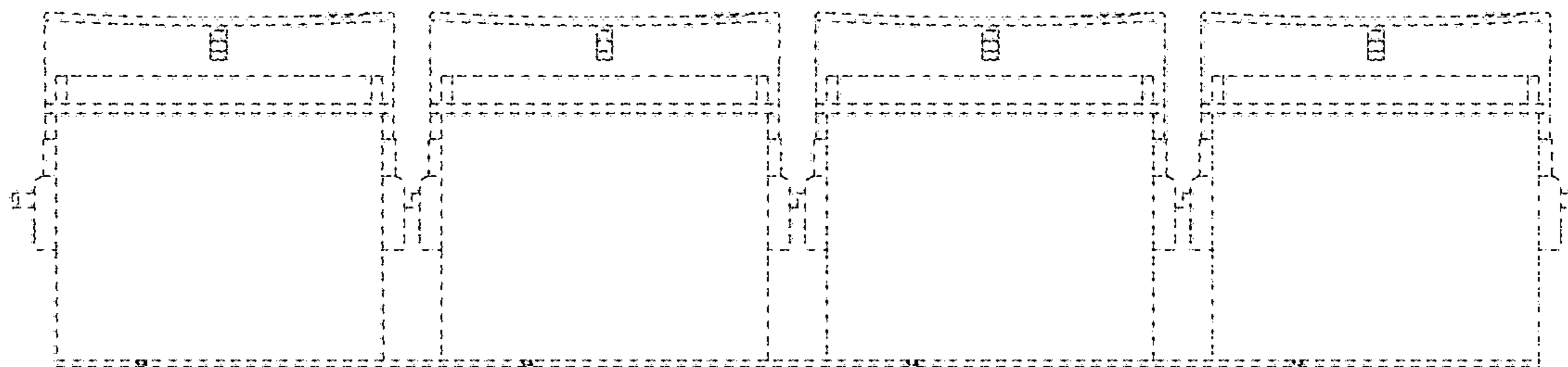

FIG. 7

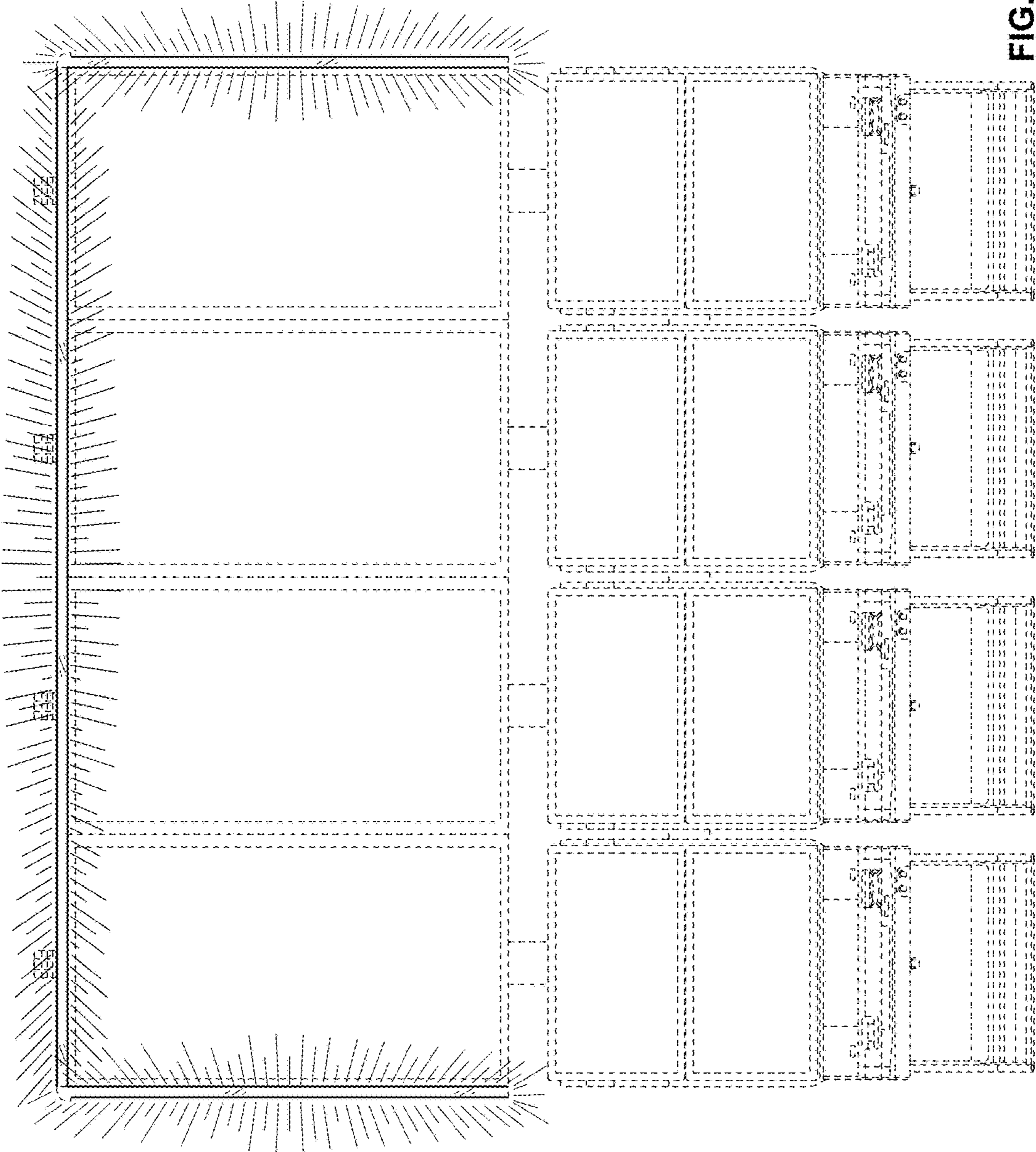

FIG. 8