



US00D846639S

(12) **United States Design Patent**  
**Fan**

(10) **Patent No.:** **US D846,639 S**

(45) **Date of Patent:** **\*\* Apr. 23, 2019**

- (54) **PEN**
- (71) Applicant: **Beifa Group Co., Ltd.**, Ningbo (CN)
- (72) Inventor: **Yumeng Fan**, Ningbo (CN)
- (73) Assignee: **Beifa Group Co., Ltd.**, Ningbo (CN)
- (\*\*) Term: **15 Years**
- (21) Appl. No.: **29/601,583**
- (22) Filed: **Apr. 24, 2017**

D572,759 S *	7/2008	Zhao .....	D19/167
D575,340 S *	8/2008	Ma .....	D19/167
D576,675 S *	9/2008	Kent .....	D19/174
D579,049 S *	10/2008	Martin .....	D19/164
D597,598 S *	8/2009	Ma .....	D19/163
D612,420 S *	3/2010	Suero, Jr. ....	D19/163
D612,421 S *	3/2010	Suero, Jr. ....	D19/163
D612,422 S *	3/2010	Suero, Jr. ....	D19/166
D616,935 S *	6/2010	Zhang .....	D19/166
D626,994 S *	11/2010	Gerules .....	D19/117
D648,786 S *	11/2011	Jianjie .....	D19/117
D678,944 S *	3/2013	Xie .....	D19/167
D685,846 S *	7/2013	Jiang .....	D19/163
D686,618 S *	7/2013	Wilson .....	D14/411
D695,826 S *	12/2013	Xie .....	D19/167

(30) **Foreign Application Priority Data**

Oct. 27, 2016 (CN) ..... 2016 3 0528843

(51) **LOC (11) Cl.** ..... **19-06**

(52) **U.S. Cl.**  
USPC ..... **D19/164; D19/913**

(58) **Field of Classification Search**  
USPC ..... D14/411; D19/115–204  
CPC . B43K 5/005; B43K 7/12; B43K 8/04; B43K  
8/06; B43K 19/00; B43K 19/02; B43K  
19/14; B43K 21/006; B43K 21/06  
See application file for complete search history.

(56) **References Cited**

**U.S. PATENT DOCUMENTS**

D223,307 S *	4/1972	Nockolds .....	D19/164
D259,792 S *	7/1981	Itoh .....	D19/169
D323,349 S *	1/1992	Gomez .....	D19/168
D404,426 S *	1/1999	Takanashi .....	D19/169
D460,485 S *	7/2002	Keda .....	D19/163
D472,924 S *	4/2003	Pan .....	D19/177
D544,034 S *	6/2007	Qiu .....	D19/166
D557,742 S *	12/2007	Vincent .....	D19/166
D567,289 S *	4/2008	Kitamura .....	D19/195
D572,754 S *	7/2008	Li .....	D19/163

\* cited by examiner

*Primary Examiner* — Elizabeth A. Albert

(74) *Attorney, Agent, or Firm* — Seed Intellectual  
Property Law Group LLP

(57) **CLAIM**

The ornamental design for a pen, as shown and described.

**DESCRIPTION**

FIG. 1 is a view of a pen rotated between a front and side elevation view showing my new design.

FIG. 2 is a front elevation view thereof.

FIG. 3 is a right side elevation view thereof, with the left side elevation view being a mirror image of the right side elevation view.

FIG. 4 is a rear elevation view thereof.

FIG. 5 is a top plan view thereof.

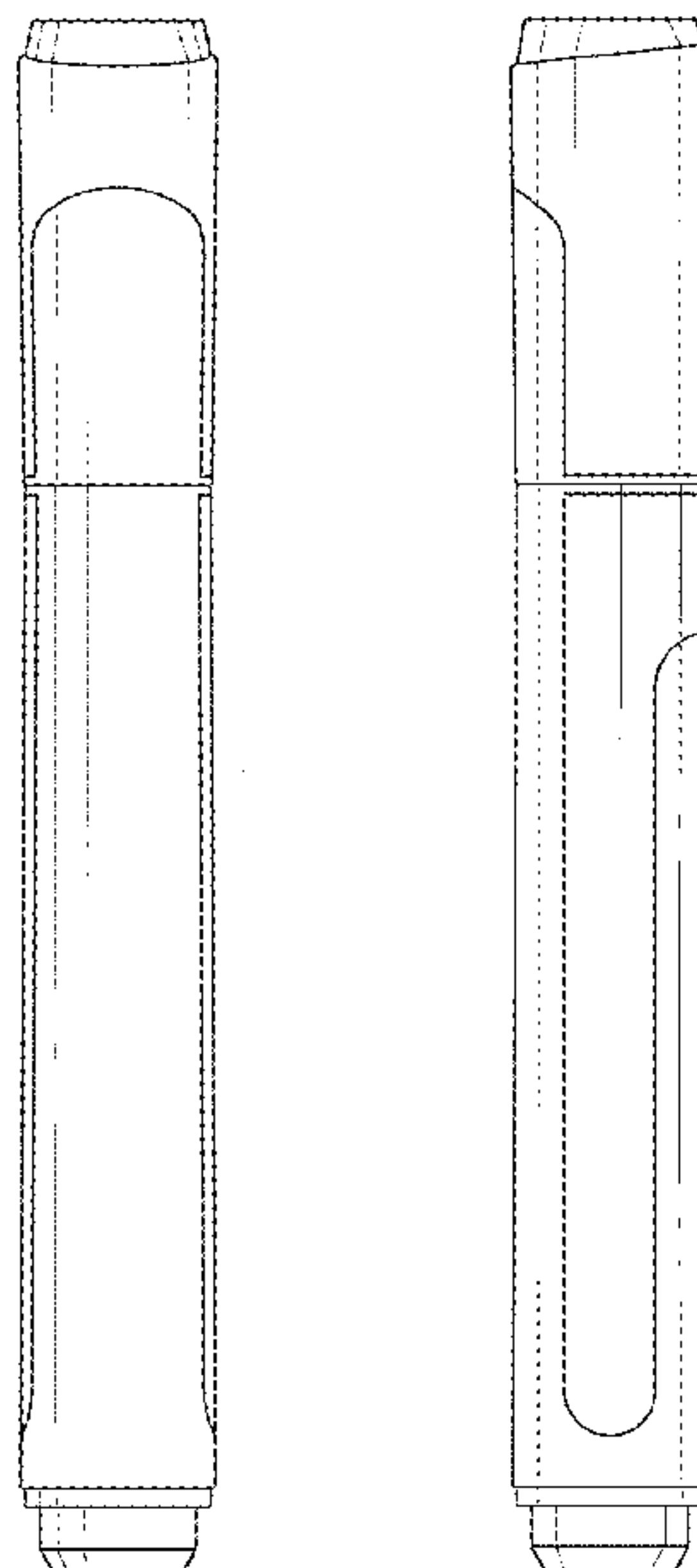
FIG. 6 is a bottom plan view thereof.

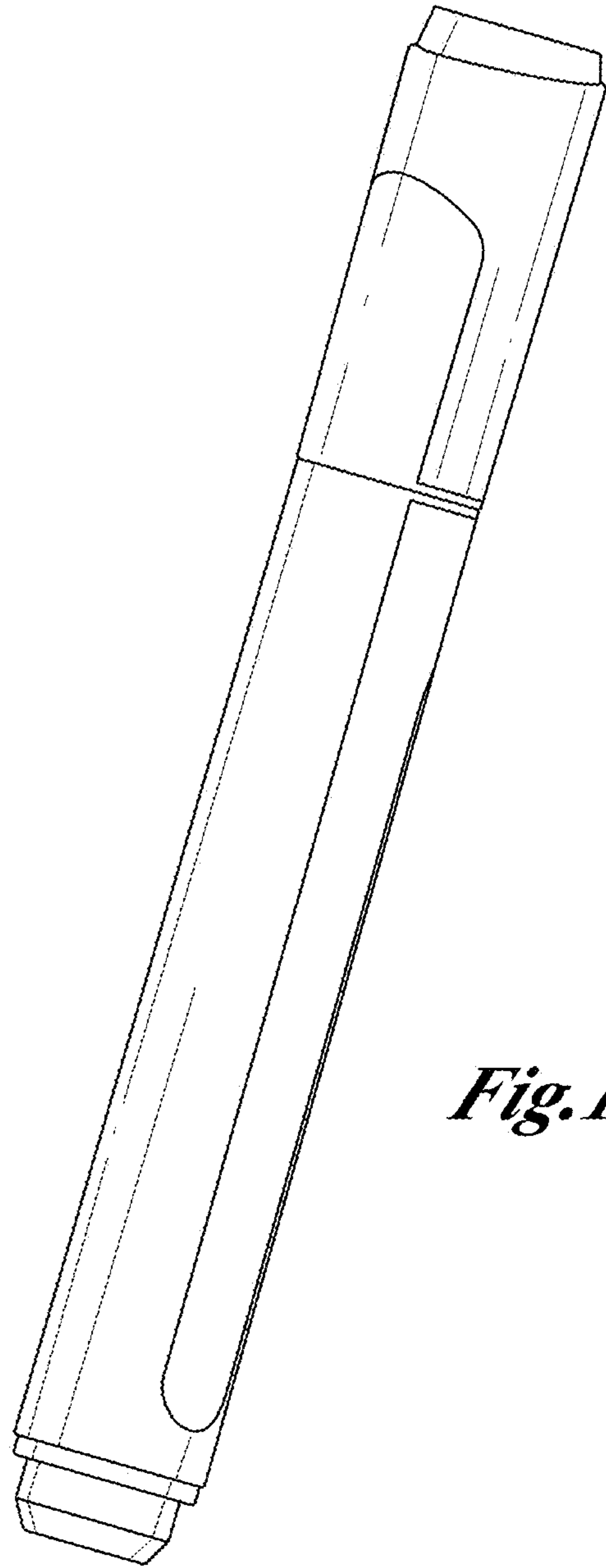
FIG. 7 is an enlarged top plan view thereof; and,

FIG. 8 is an enlarged bottom plan view thereof.

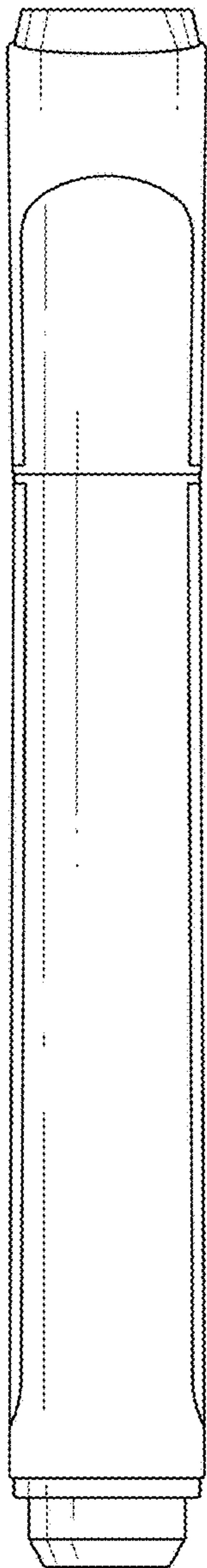
The broken lines in the figures illustrate environment only and form no part of the claimed design.

**1 Claim, 3 Drawing Sheets**

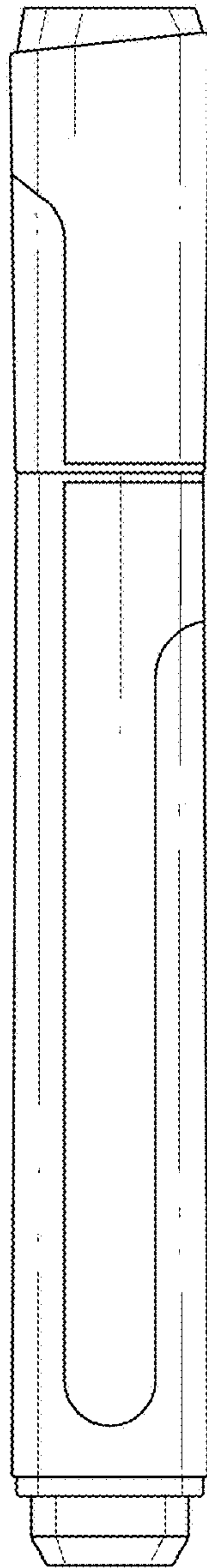




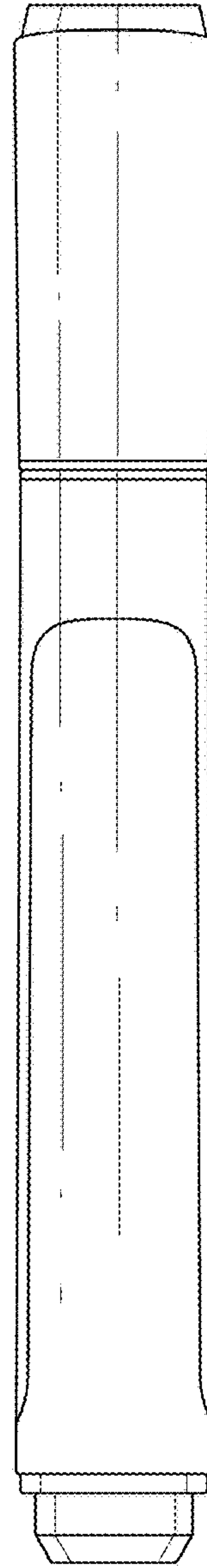
*Fig. 1.*



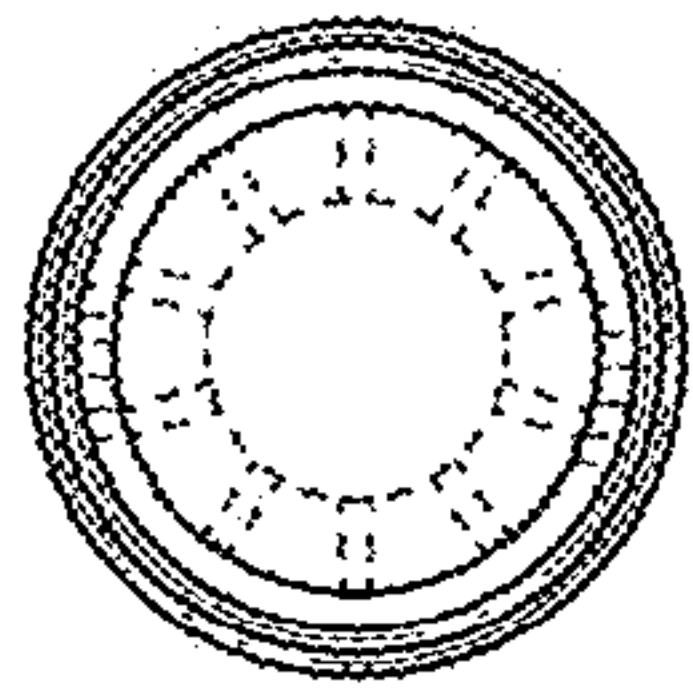
*Fig. 2.*



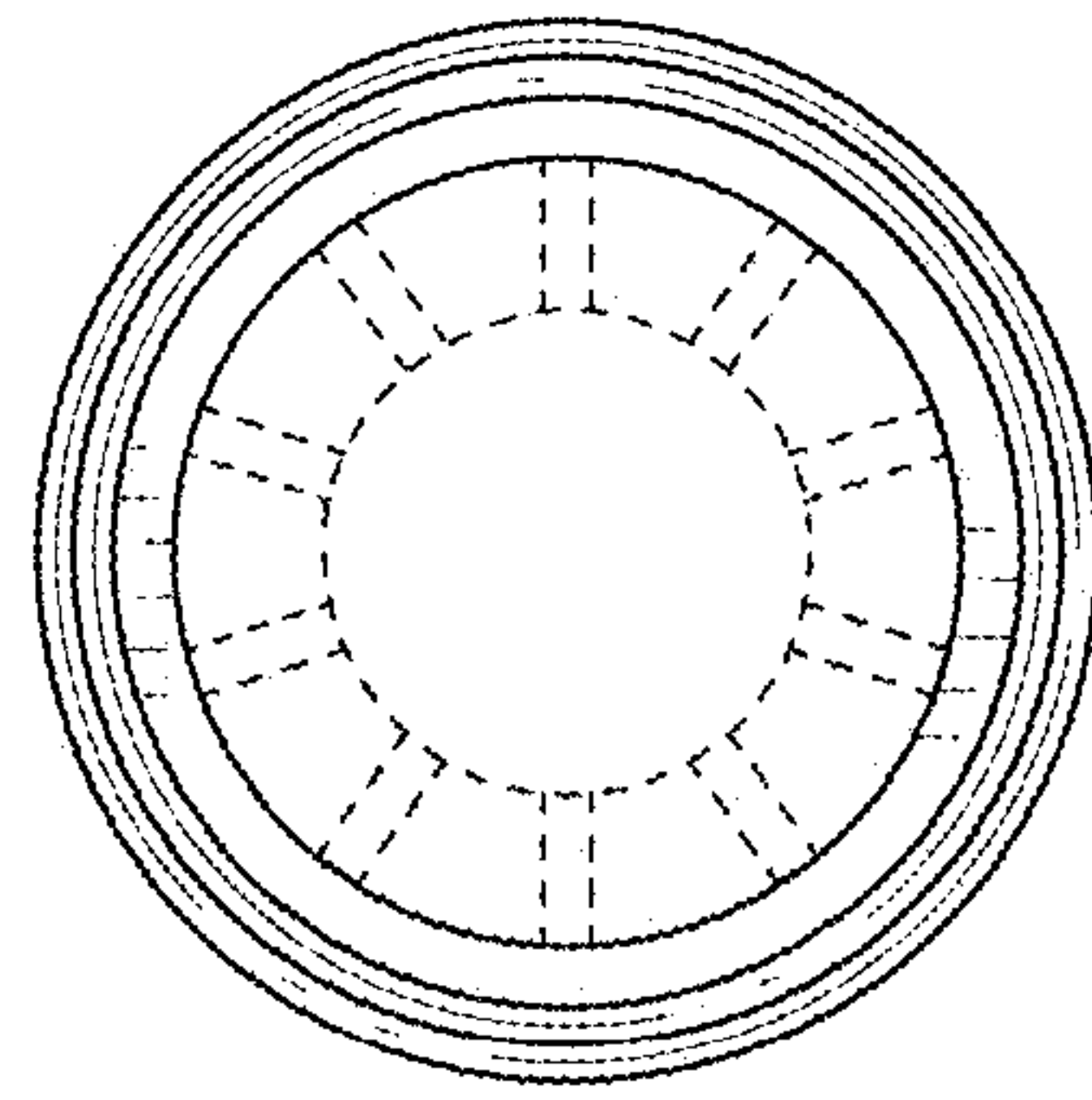
*Fig. 3.*



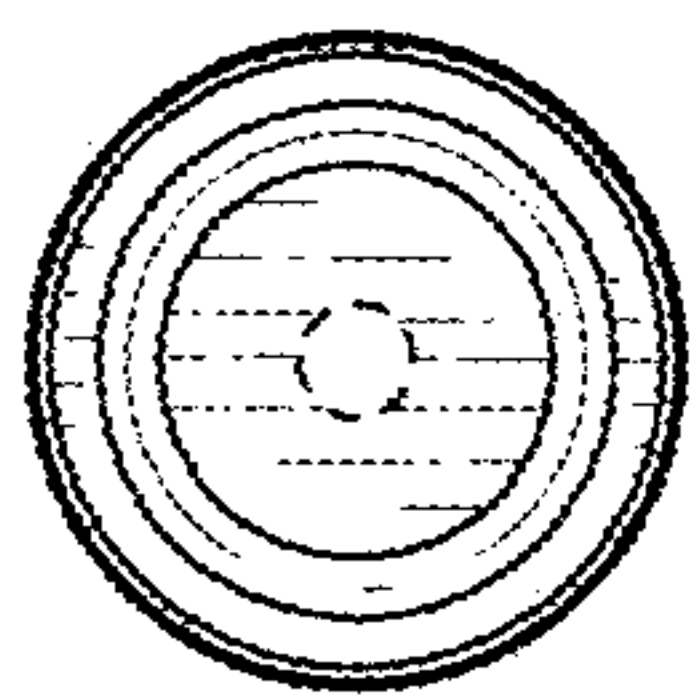
*Fig. 4.*



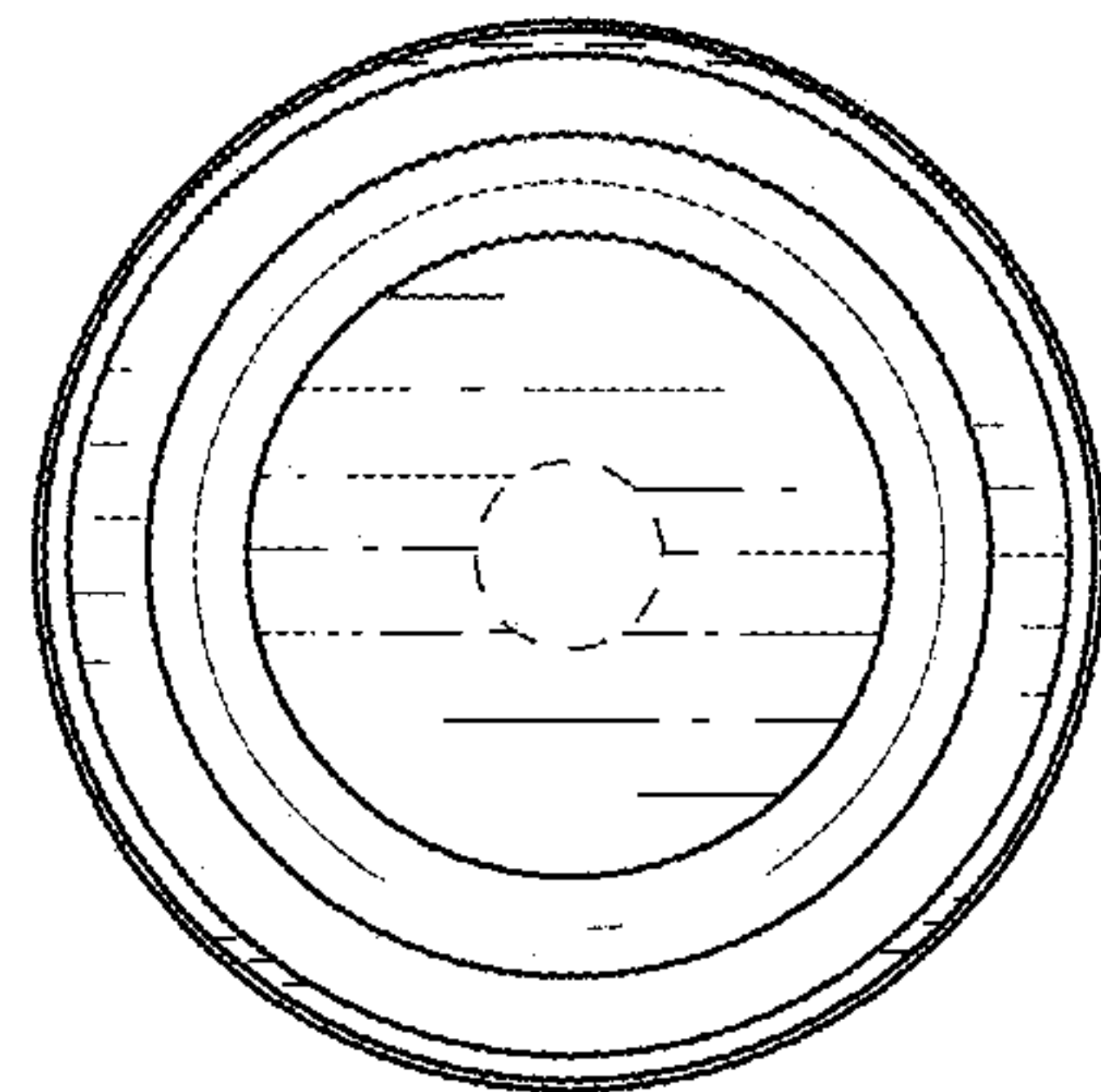
*Fig. 5.*



*Fig. 7.*



*Fig. 6.*



*Fig. 8.*