



US00D846518S

(12) **United States Design Patent** (10) **Patent No.:** **US D846,518 S**
McManigal et al. (45) **Date of Patent:** **** Apr. 23, 2019**

(54) **TELEVISION**

(71) Applicant: **Vizio Inc**, Irvine, CA (US)
 (72) Inventors: **Scott McManigal**, Irvine, CA (US);
Howard Cheng, Irvine, CA (US); **Glen Kim**, Irvine, CA (US)
 (73) Assignee: **Vizio Inc**, Irvine, CA (US)

(**) Term: **15 Years**

(21) Appl. No.: **29/630,974**

(22) Filed: **Dec. 26, 2017**

(51) **LOC (11) Cl.** **14-03**

(52) **U.S. Cl.**
USPC **D14/126**

(58) **Field of Classification Search**
 USPC D14/125-134, 239, 371, 136, 374-377,
 D14/440, 450, 448, 336, 342, 159;
 312/7.2; 348/836, 838, 180, 184, 325,
 348/739; 248/917-924, 465; 345/104,
 345/133, 156, 168, 87, 173; D21/329,
 D21/515, 577, 622, 333, 433, 448, 452,
 D21/450, 331, 505; D10/15, 26;
 446/484, 175, 356; D6/477, 479, 300;
 D24/185; D34/14
 CPC ... G06F 1/1601; G06F 1/1643; H05K 5/0004;
 H05K 5/0017; H05K 5/02; H05K 5/0217
 See application file for complete search history.

(56) **References Cited**

U.S. PATENT DOCUMENTS

D782,433	S	*	3/2017	Lee	D14/126
D782,991	S	*	4/2017	Kim	D14/126
D785,581	S	*	5/2017	McManigal	D14/126
D786,812	S	*	5/2017	McManigal	D14/126
D786,813	S	*	5/2017	McManigal	D14/126

* cited by examiner

Primary Examiner — Randall H Gholson

(74) *Attorney, Agent, or Firm* — Law Office of Scott C Harris, Inc

(57) **CLAIM**

The ornamental design for a television, as shown and described.

DESCRIPTION

FIG. 1 shows a first perspective view of the television;
 FIG. 2 shows a front view of the television;
 FIG. 3 shows a rear view of the television;
 FIG. 4 shows a first side view of the television;
 FIG. 5 shows a second side view of the television;
 FIG. 6 shows a top side view of the television;
 FIG. 7 shows a bottom side view of the television; and,
 FIG. 8 shows a rear perspective view of the television.
 The portions shown in broken lines form no part of the claimed design.

1 Claim, 6 Drawing Sheets

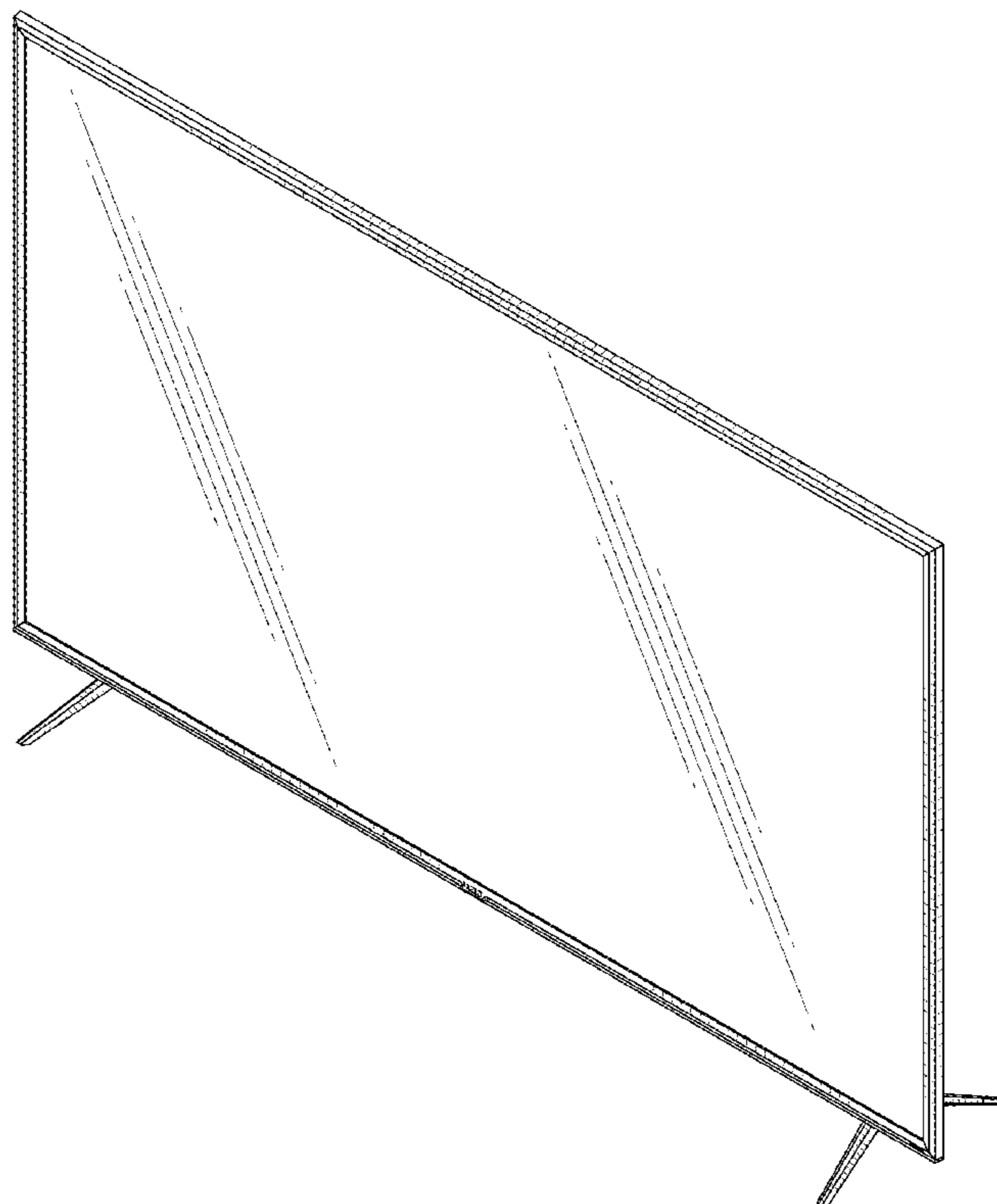

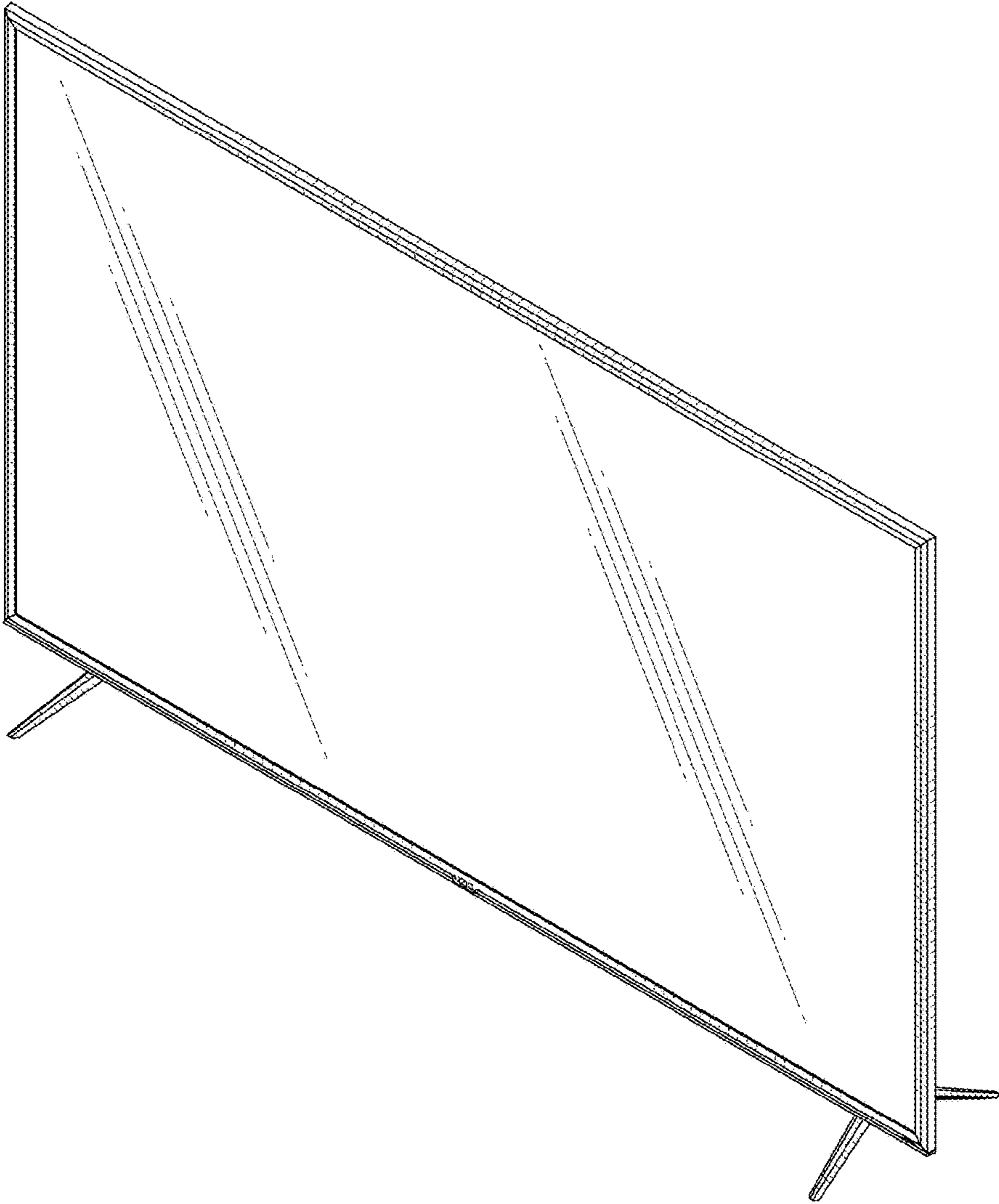

FIG. 1

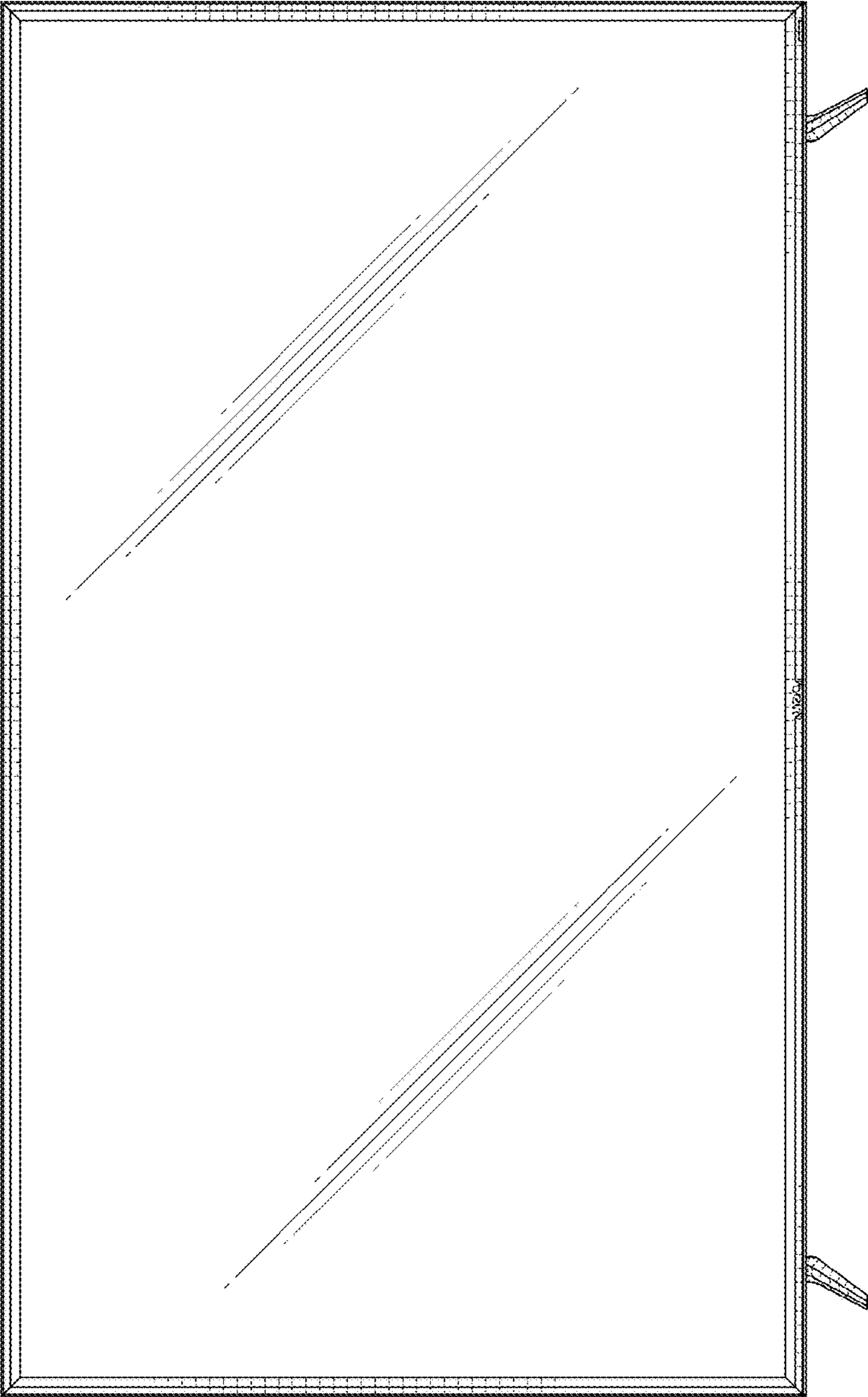

FIG. 2

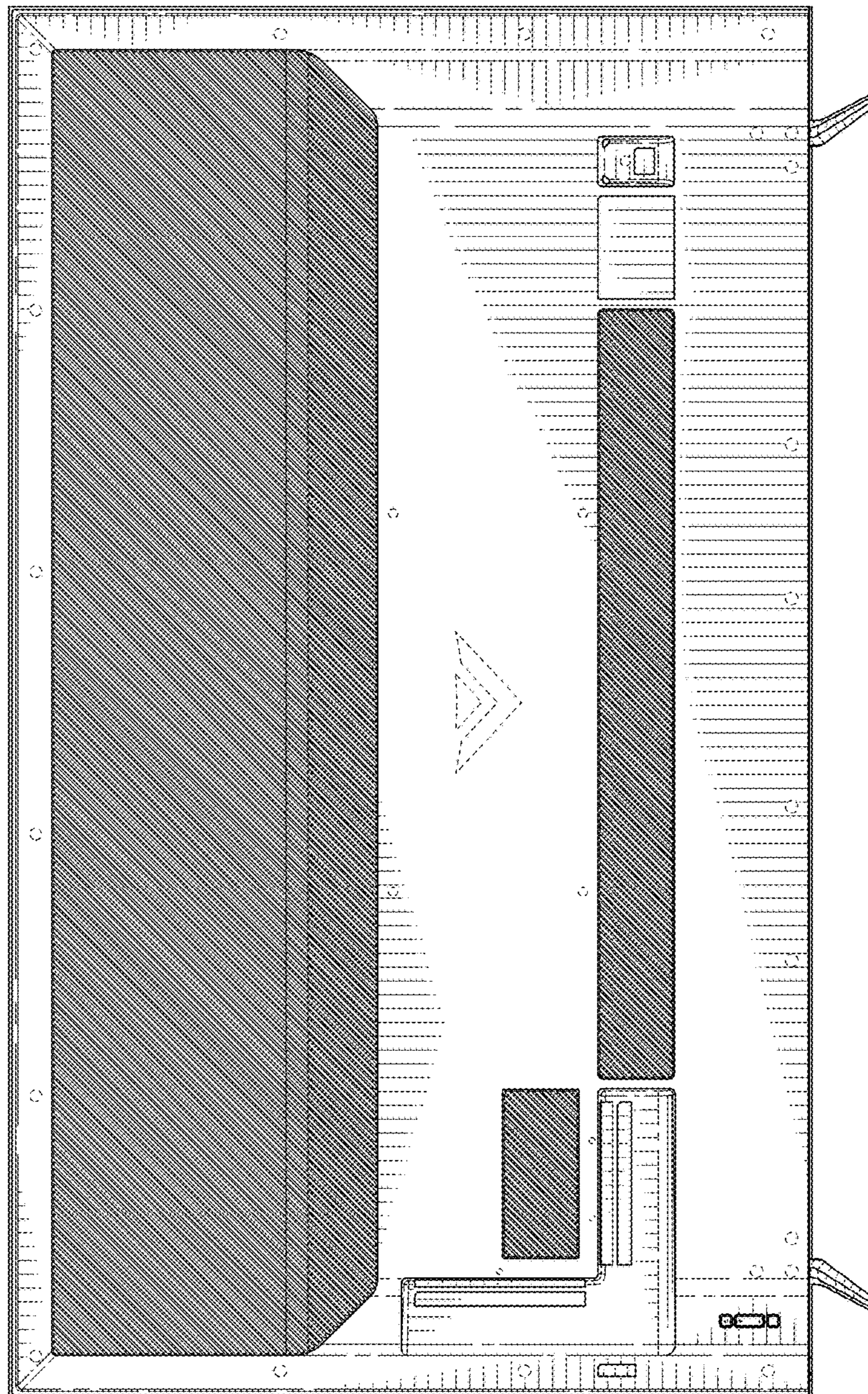

FIG. 3

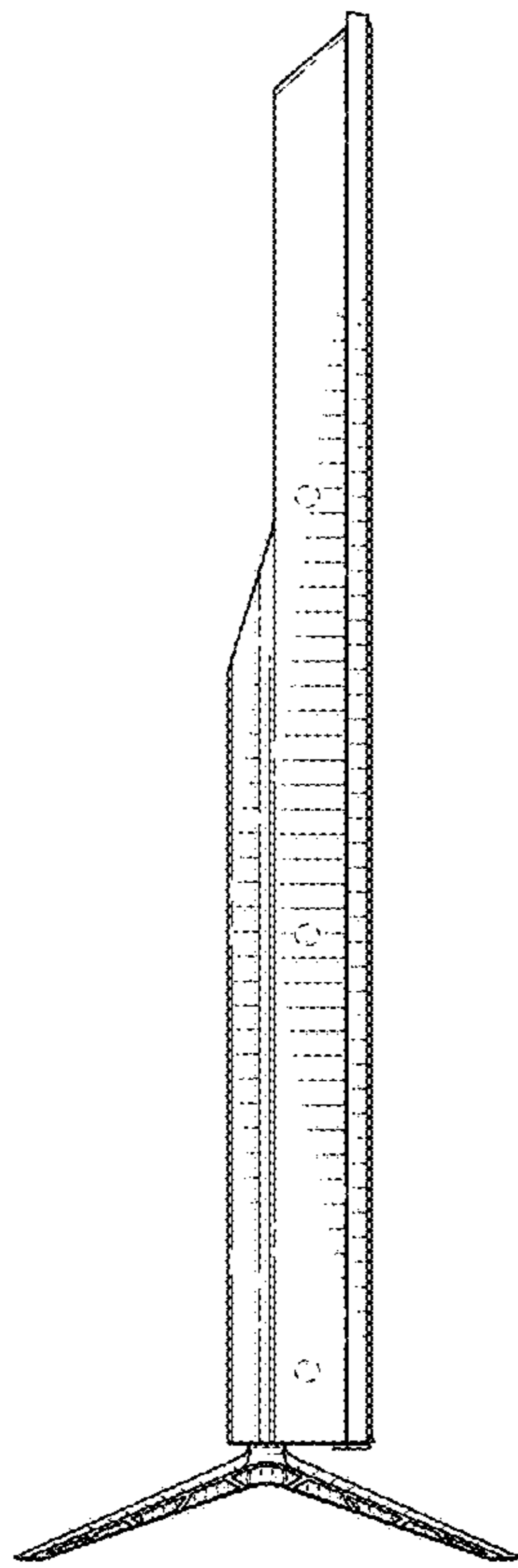

FIG. 4

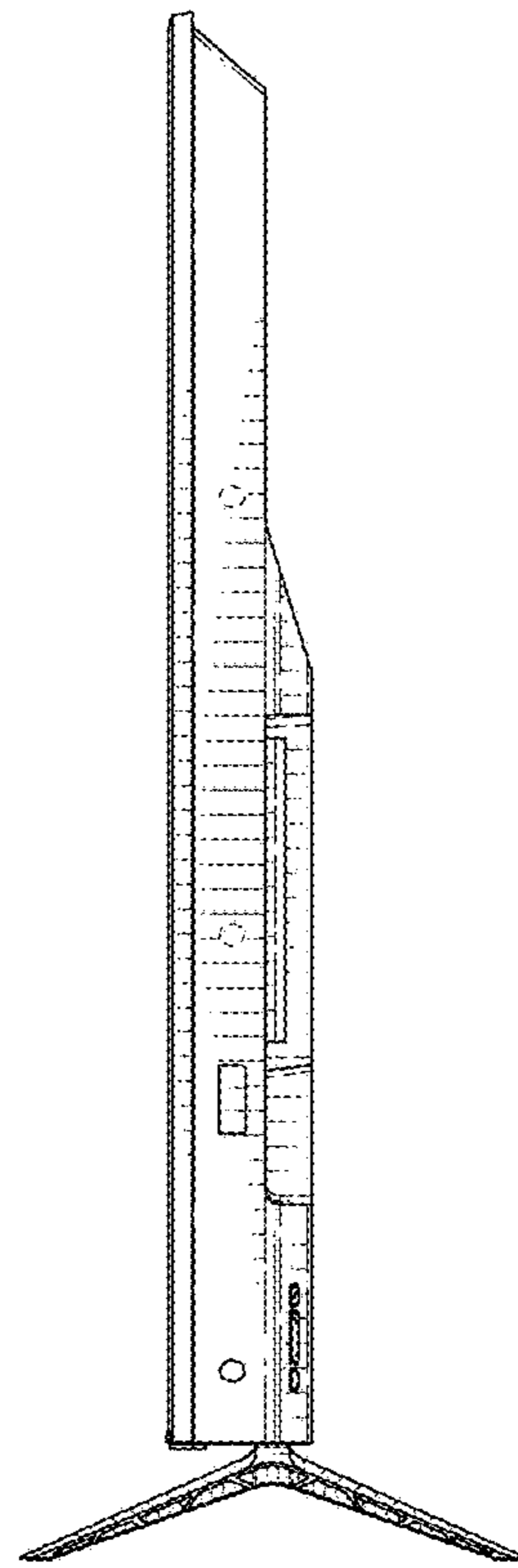

FIG. 5

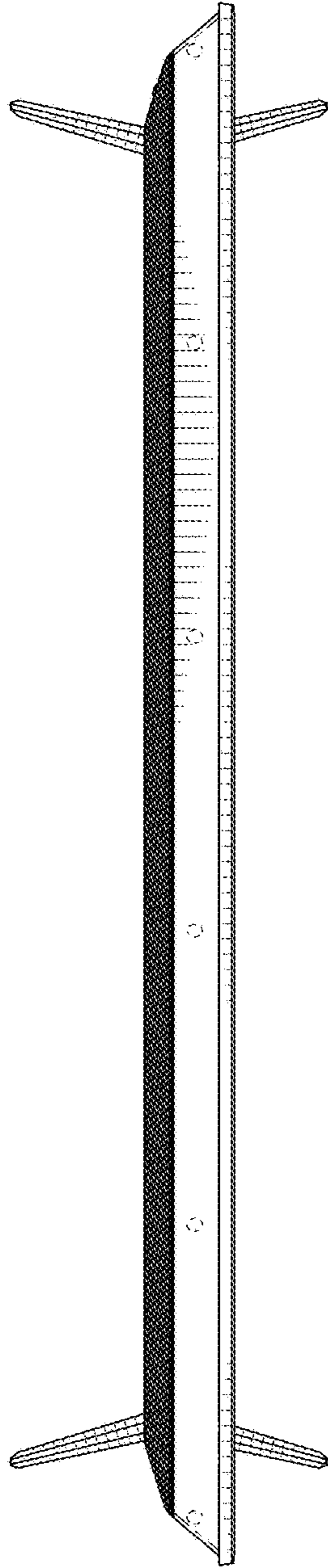

FIG. 6

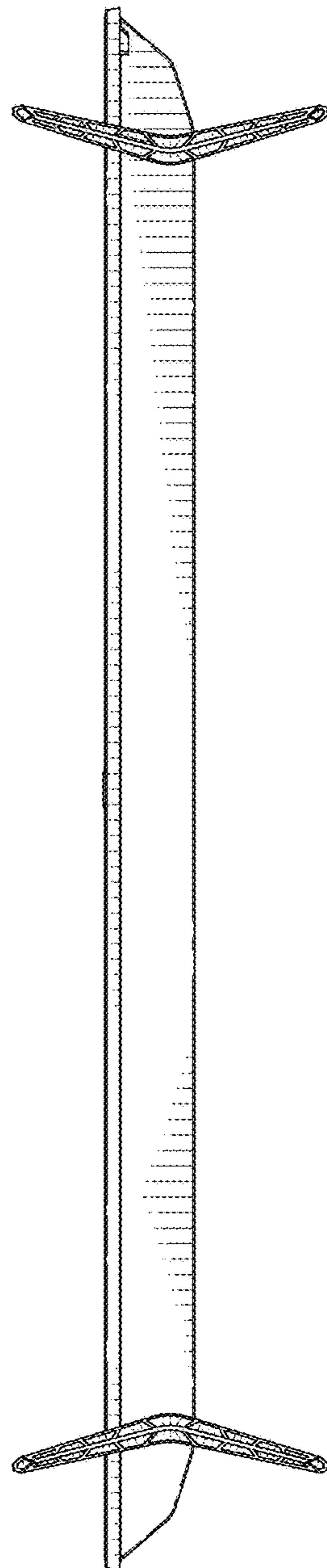

FIG. 7

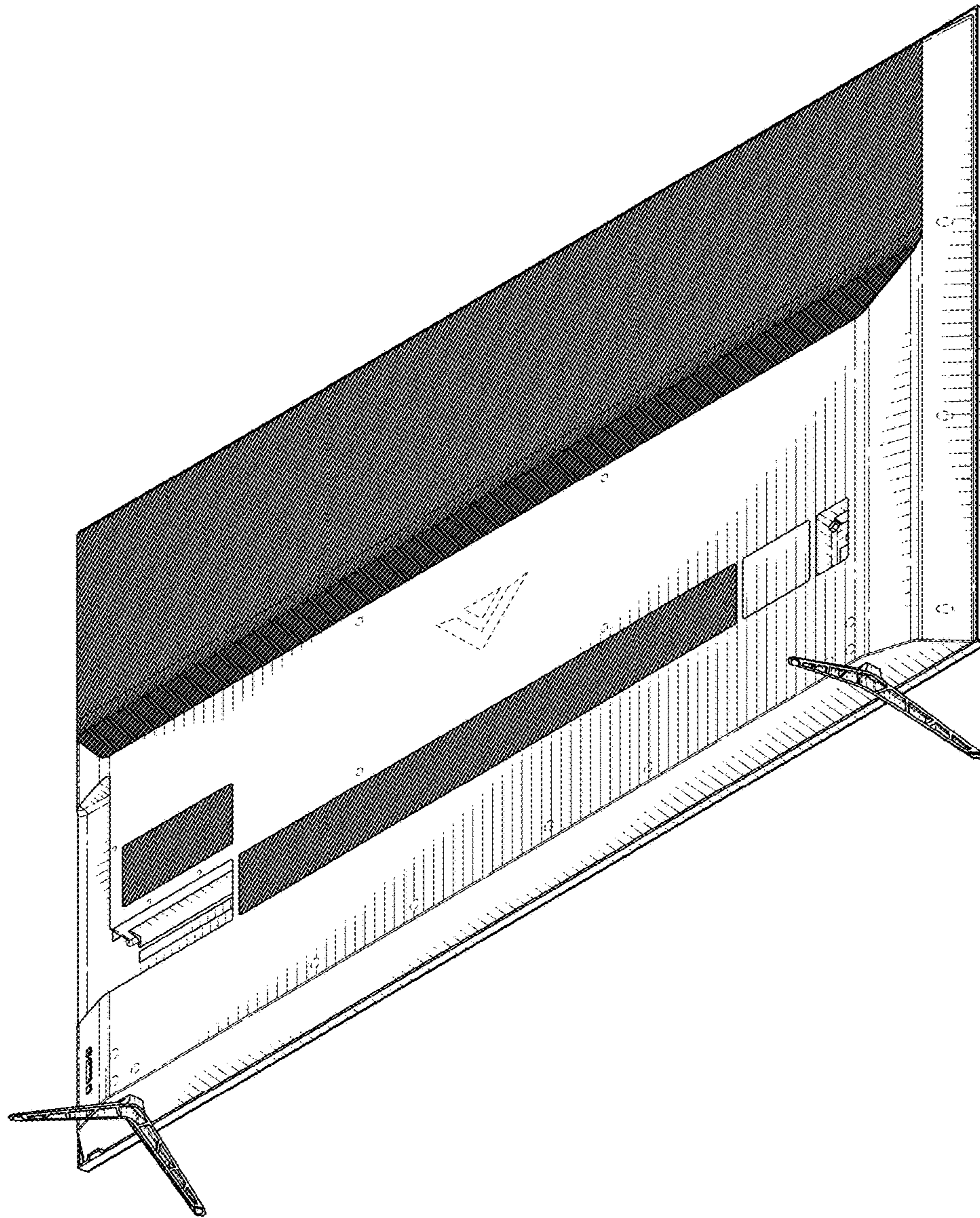

FIG. 8