



US00D846513S

(12) **United States Design Patent** (10) **Patent No.:** **US D846,513 S**  
**Takebayashi et al.** (45) **Date of Patent:** **\*\* Apr. 23, 2019**

(54) **SHEET HEATER FOR ELECTROSTATIC CHUCK**

(71) Applicant: **NGK Insulators, Ltd.**, Nagoya-Shi (JP)

(72) Inventors: **Hiroshi Takebayashi**, Nagoya (JP);  
**Rishun Kin**, Nagoya (JP)

(73) Assignee: **NGK Insulators, Ltd.**, Nagoya (JP)

(\*\*) Term: **15 Years**

(21) Appl. No.: **29/581,749**

(22) Filed: **Oct. 21, 2016**

(30) **Foreign Application Priority Data**

Apr. 27, 2016 (JP) ..... 2016-009254  
Apr. 27, 2016 (JP) ..... 2016-009255  
Apr. 27, 2016 (JP) ..... 2016-009258

(51) **LOC (11) Cl.** ..... **13-03**

(52) **U.S. Cl.**  
USPC ..... **D13/182**

(58) **Field of Classification Search**  
USPC ..... D13/182; 219/443.1, 444.1; 118/724,  
118/725

(Continued)

(56) **References Cited**

**U.S. PATENT DOCUMENTS**

D266,070 S \* 9/1982 Asanuma ..... D13/179  
D266,074 S \* 9/1982 Asanuma ..... D13/179

(Continued)

**OTHER PUBLICATIONS**

Rectangle, Webster's Dictionary, 1913, <http://www.webster-dictionary.org/definition/Rectangle>.\*

*Primary Examiner* — Elizabeth J Oswecki

(74) *Attorney, Agent, or Firm* — Burr & Brown, PLLC

(57) **CLAIM**

The ornamental design for a sheet heater for electrostatic chuck, as shown and described.

**DESCRIPTION**

FIG. 1 is a front view of a first embodiment of a sheet heater for electrostatic chuck illustrating our new design;

FIG. 2 is a rear view thereof;

FIG. 3 is a top view thereof, the bottom view thereof being a mirror image;

FIG. 4 is a right view thereof, the left view thereof being a mirror image;

FIG. 5 is an enlarged view taken along line 5-5 in FIG. 1;

FIG. 6 is an enlarged view taken along line 6-6 in FIG. 5;

FIG. 7 is an enlarged view taken along line 7-7 in FIG. 6;

FIG. 8 is an enlarged view taken along line 8-8 in FIG. 7;

FIG. 9 is a front view of a second embodiment of a sheet heater for electrostatic chuck illustrating our new design;

FIG. 10 is a rear view thereof;

FIG. 11 is a top view thereof, the bottom view thereof being a mirror image;

FIG. 12 is a right view thereof, the left view thereof being a mirror image;

FIG. 13 is an enlarged view taken along line 13-13 in FIG. 9;

FIG. 14 is an enlarged view taken along line 14-14 in FIG. 13;

FIG. 15 is an enlarged view taken along line 15-15 in FIG. 14;

FIG. 16 is an enlarged view taken along line 16-16 in FIG. 15;

FIG. 17 is a front view of a third embodiment of a sheet heater for electrostatic chuck illustrating our new design;

FIG. 18 is a rear view thereof;

FIG. 19 is a top view thereof, the bottom view thereof being a mirror image;

FIG. 20 is a right view thereof, the left view thereof being a mirror image;

FIG. 21 is an enlarged view taken along line 21-21 in FIG. 17;

(Continued)

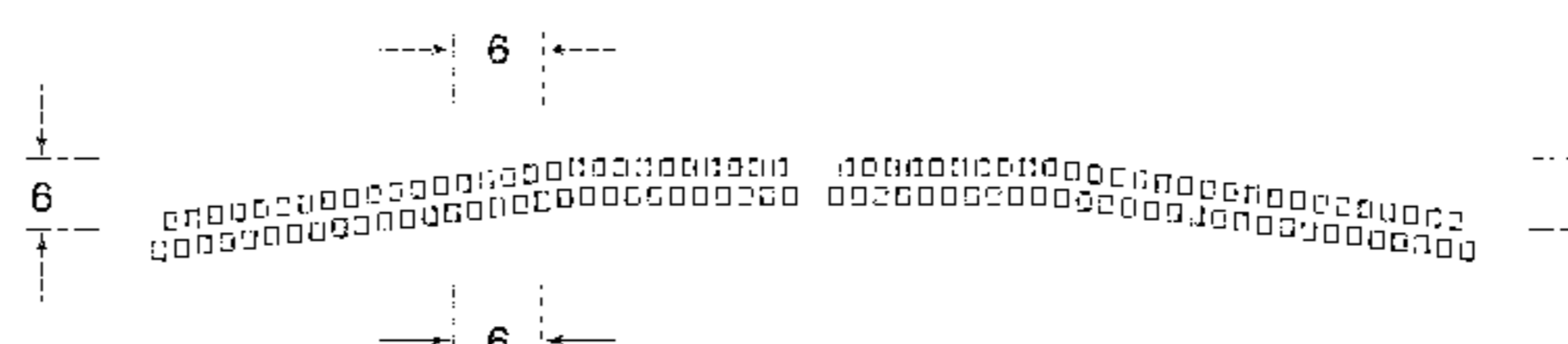
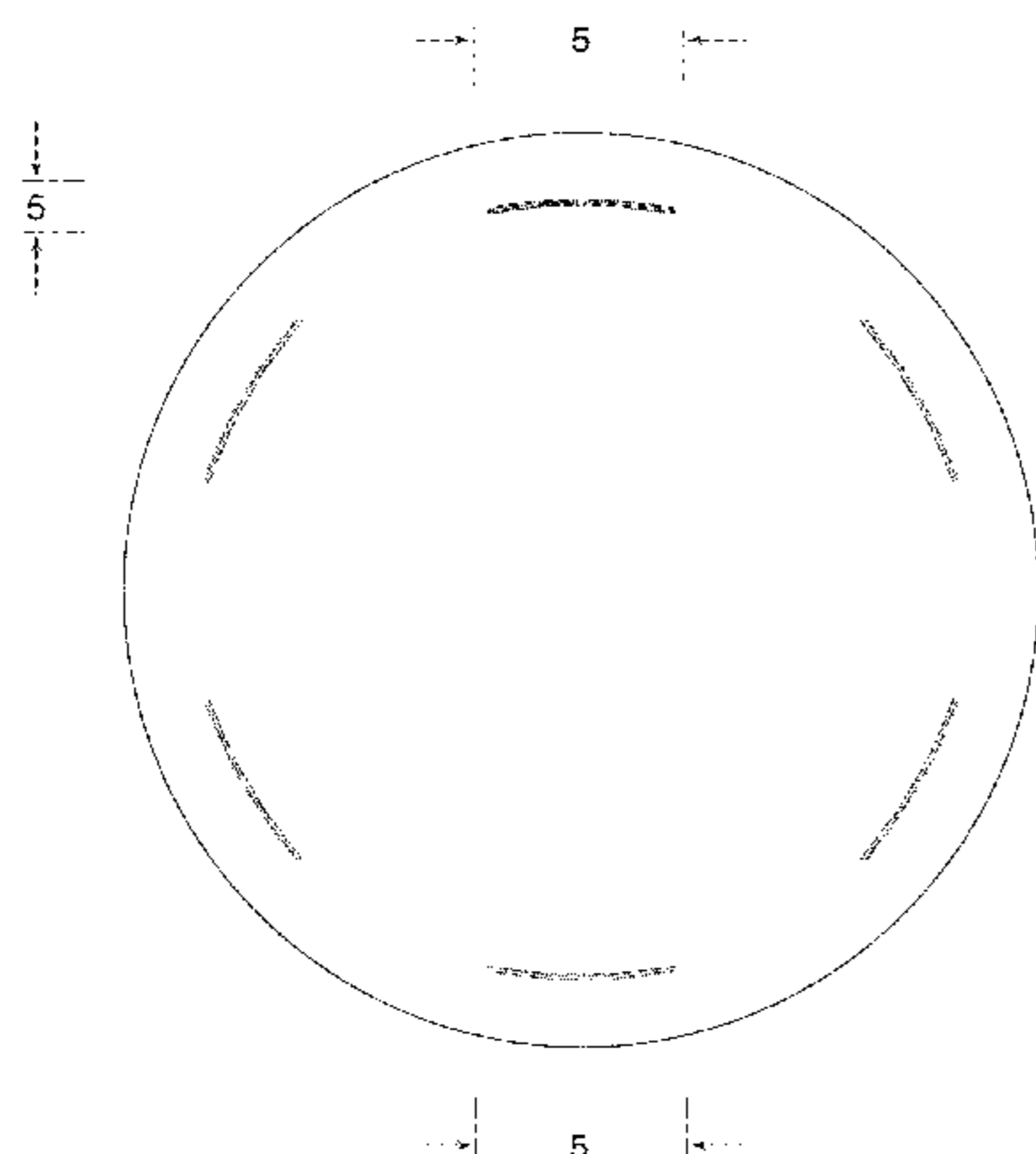

FIG. 22 is an enlarged view taken along line 22-22 in FIG. 21;  
 FIG. 23 is an enlarged view taken along line 23-23 in FIG. 22; and,  
 FIG. 24 is an enlarged view taken along line 24-24 in FIG. 23.

The broken lines in the drawings depict unclaimed subject matter only and form no part of the claimed design.

**1 Claim, 24 Drawing Sheets**

(58) **Field of Classification Search**

CPC ..... H01J 2237/332; H01J 2237/338; H01J 37/32642; H01L 21/67069; H01L 21/67103; H01L 21/67109; H01L 21/67248; H01L 21/683; H01L 21/6831; H01L 21/68714; H01L 21/68792

See application file for complete search history.

(56) **References Cited**

U.S. PATENT DOCUMENTS

D266,077 S \* 9/1982 Asanuma ..... D13/179  
 D273,582 S \* 4/1984 Bolt ..... D13/182

D273,860 S \* 5/1984 Bolt ..... D13/182  
 D327,883 S \* 7/1992 Gloton ..... D13/182  
 D328,599 S \* 8/1992 Gloton ..... D13/182  
 D370,464 S \* 6/1996 Tepper ..... D13/147  
 D405,427 S \* 2/1999 Ishii ..... D13/182  
 6,133,557 A \* 10/2000 Kawanabe ..... H01L 21/67103  
 219/544  
 D466,093 S \* 11/2002 Ebihara ..... D13/182  
 D471,167 S \* 3/2003 Ebihara ..... D13/182  
 D529,031 S \* 9/2006 Huang ..... D13/182  
 D540,272 S \* 4/2007 Higashibata ..... D13/182  
 D589,471 S \* 3/2009 Komatsu ..... D13/182  
 D598,380 S \* 8/2009 Kuriki ..... D13/133  
 D601,521 S \* 10/2009 Komatsu ..... D13/182  
 D613,690 S \* 4/2010 Kuriki ..... D13/133  
 D615,927 S \* 5/2010 Kuriki ..... D13/133  
 D651,991 S \* 1/2012 Nishiguchi ..... D13/182  
 D651,992 S \* 1/2012 Nishiguchi ..... D13/182  
 D655,256 S \* 3/2012 Nishiguchi ..... D13/182  
 D690,672 S \* 10/2013 Yoshida ..... D13/182  
 D699,201 S \* 2/2014 Petsch ..... D13/182  
 8,981,263 B2 \* 3/2015 Sasaki ..... H01L 21/6831  
 118/725  
 D775,092 S \* 12/2016 Vinciarelli ..... D13/182  
 D797,690 S \* 9/2017 Furutani ..... D13/182  
 D798,250 S \* 9/2017 Furutani ..... D13/182

\* cited by examiner

Fig. 1

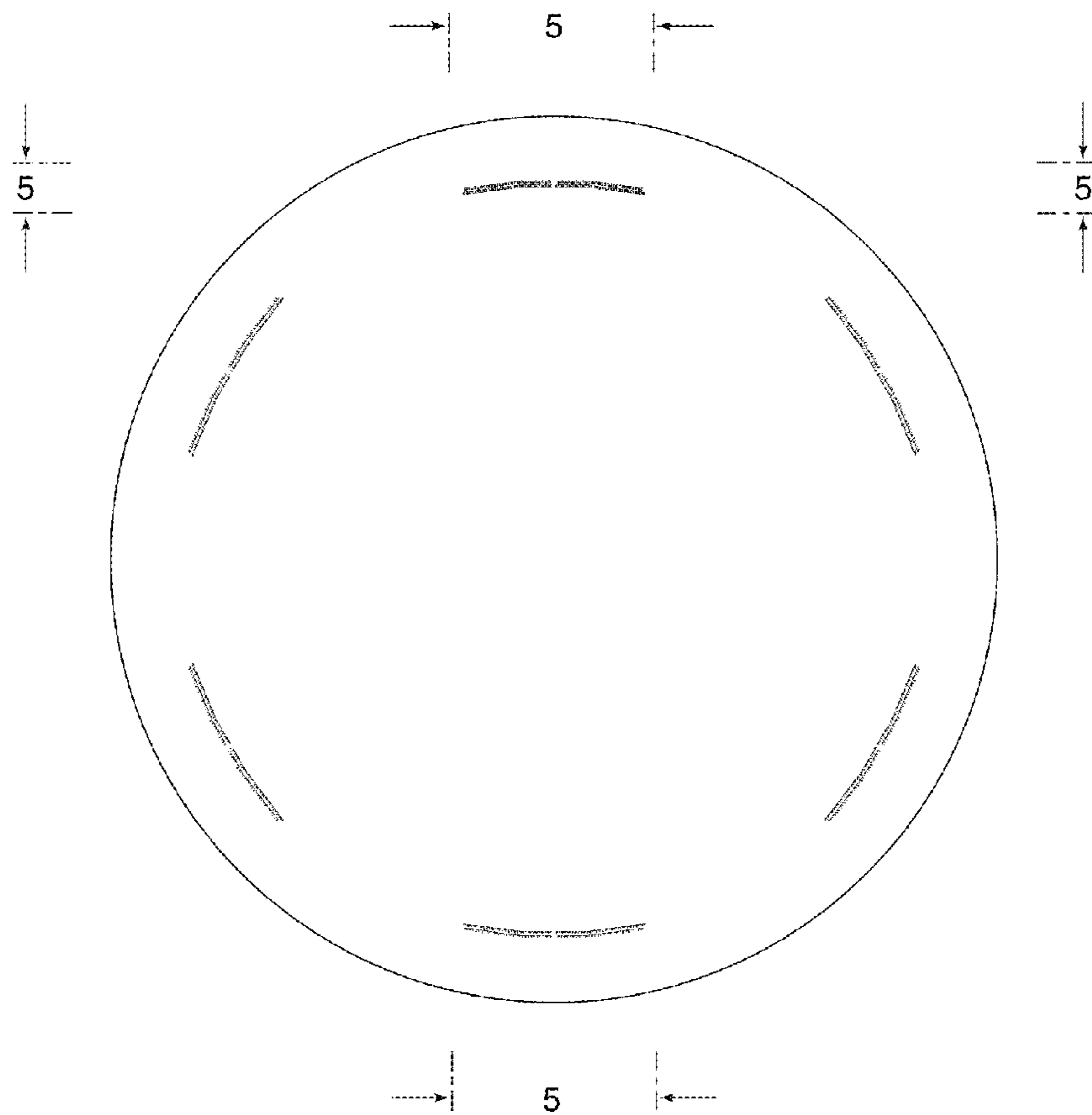

Fig.2

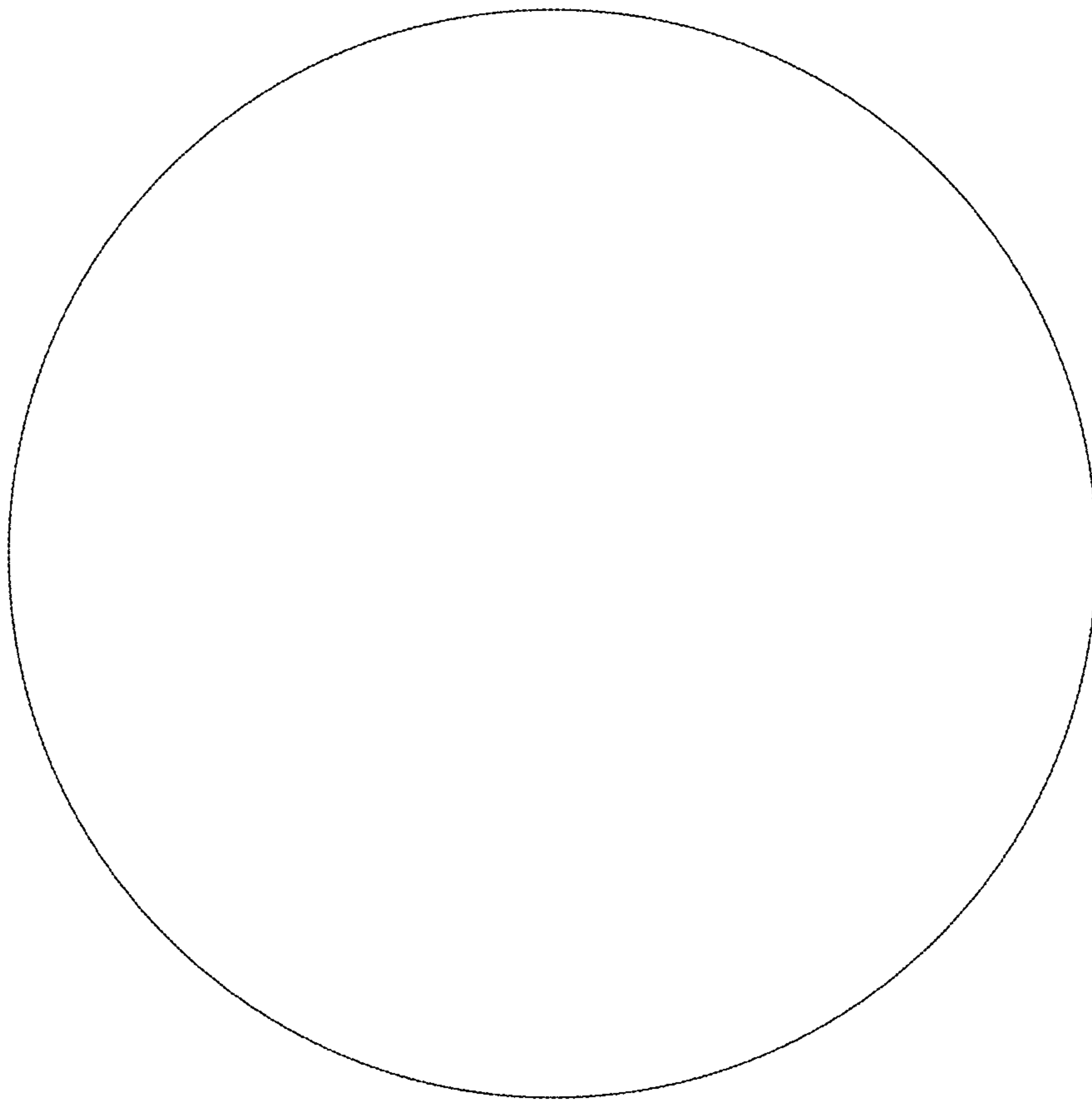

Fig. 3



Fig. 4

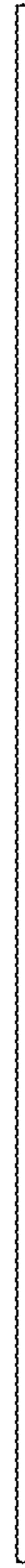

Fig.5

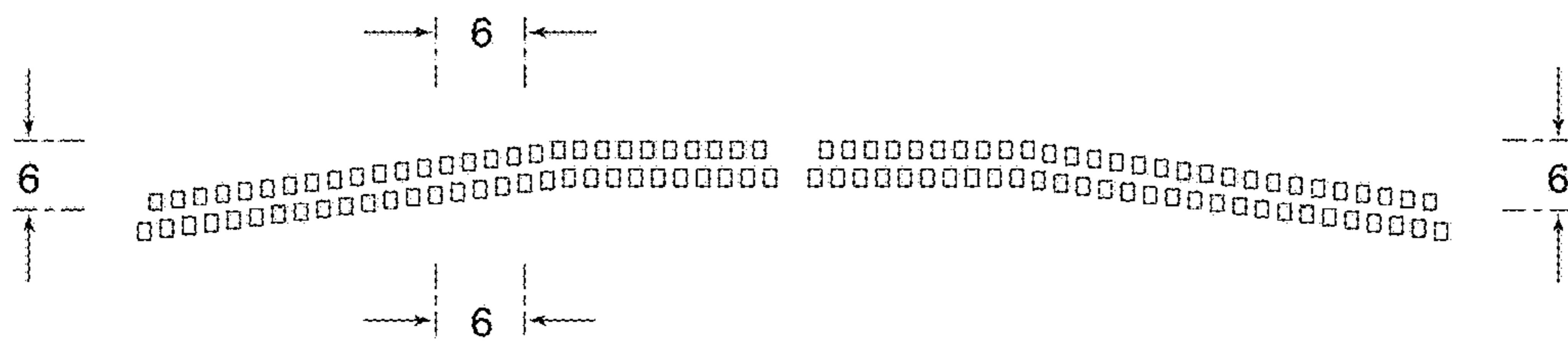

Fig.6

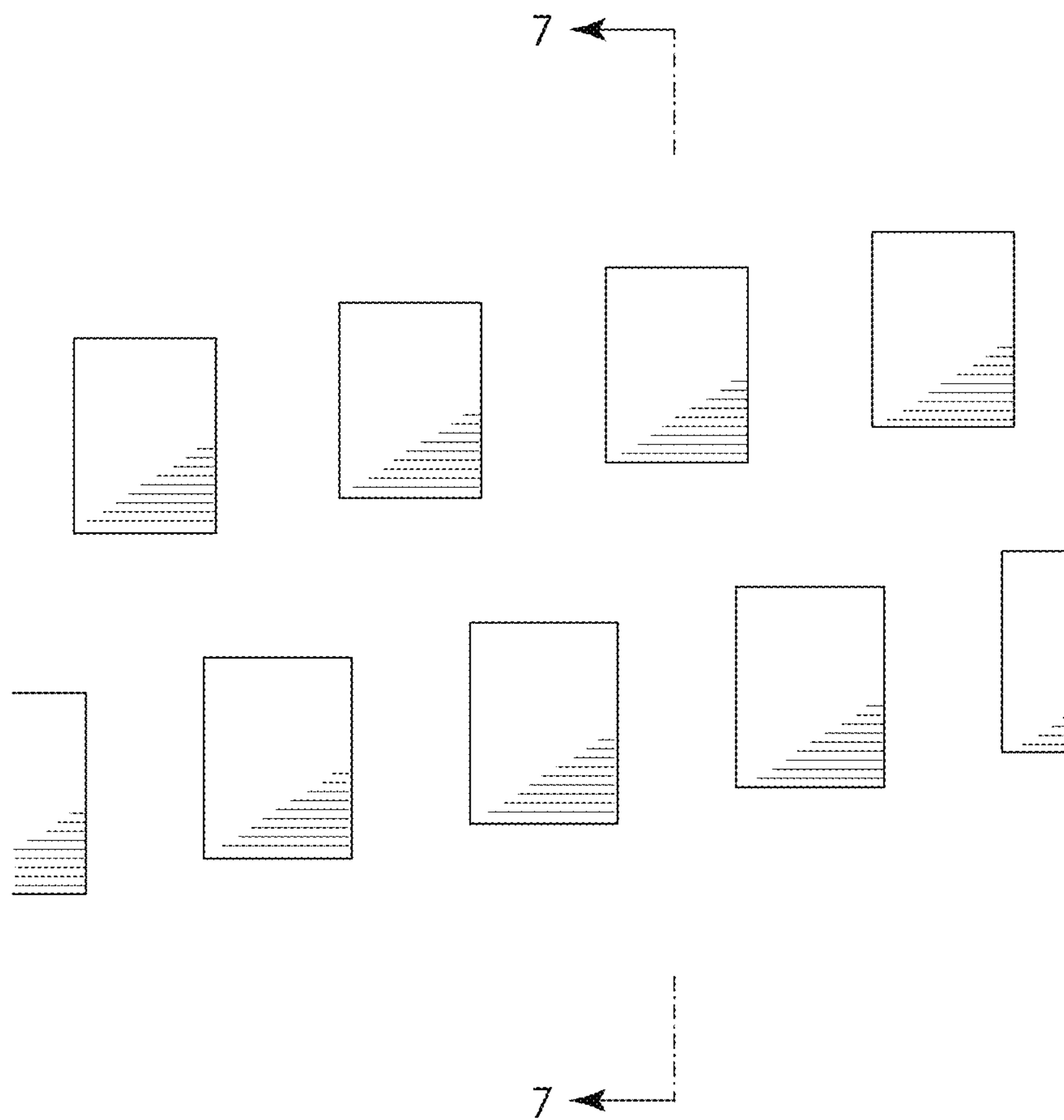



Fig. 7

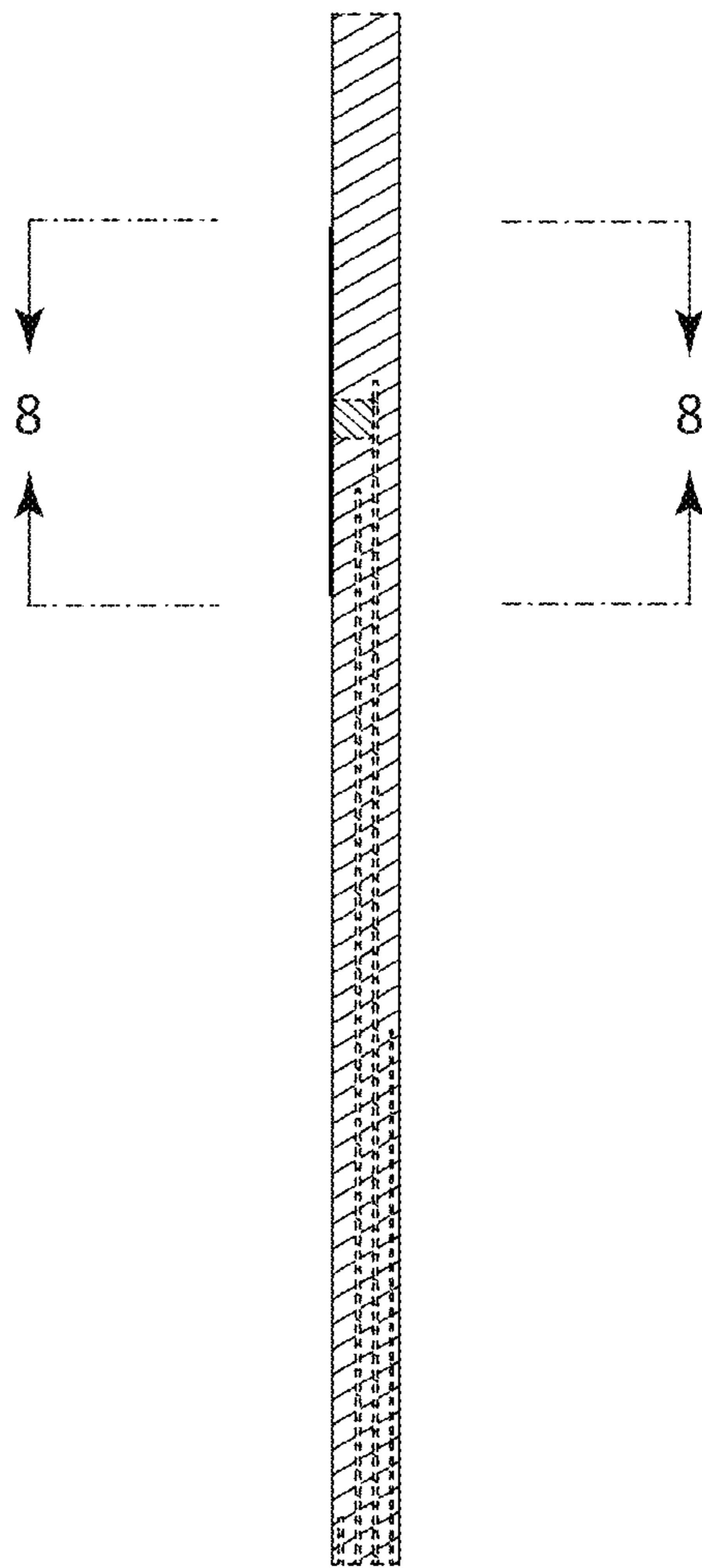

Fig. 8

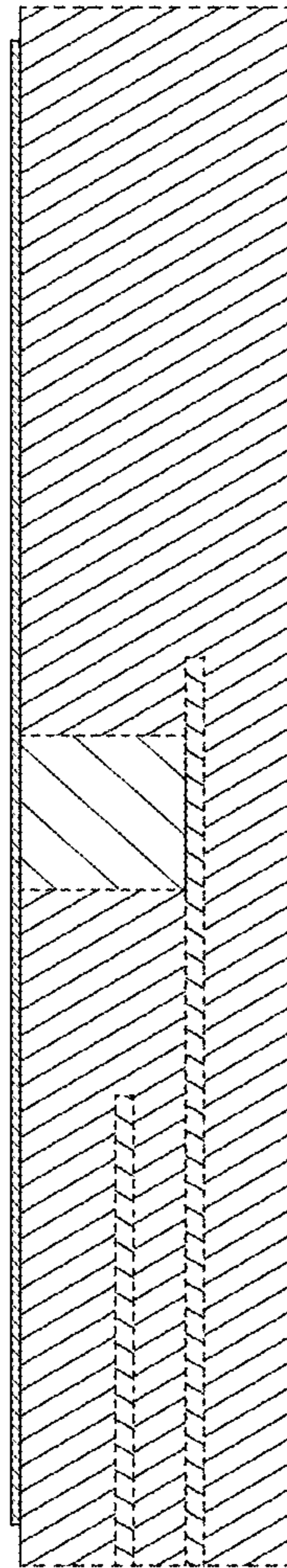

Fig.9

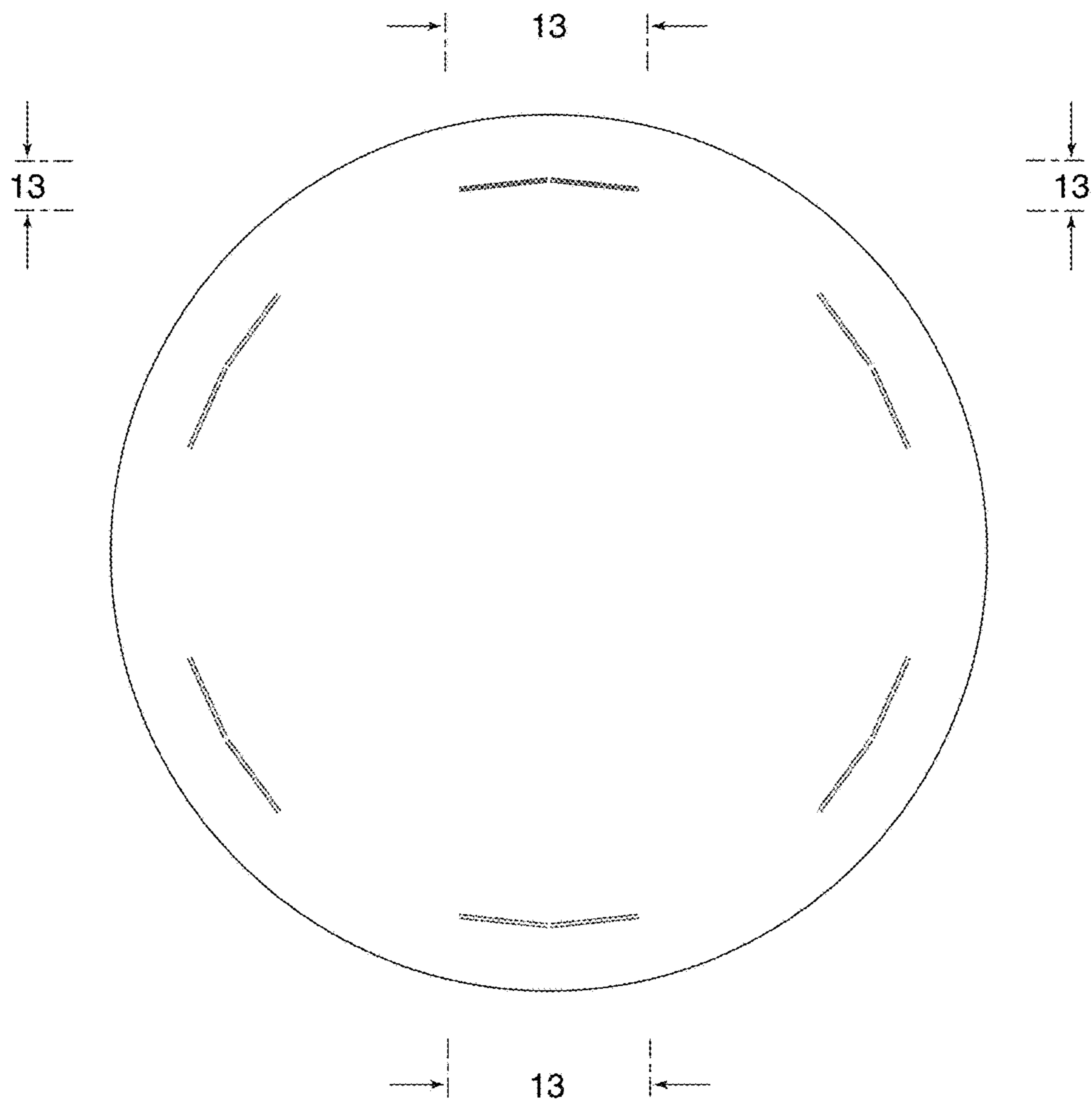

Fig. 10

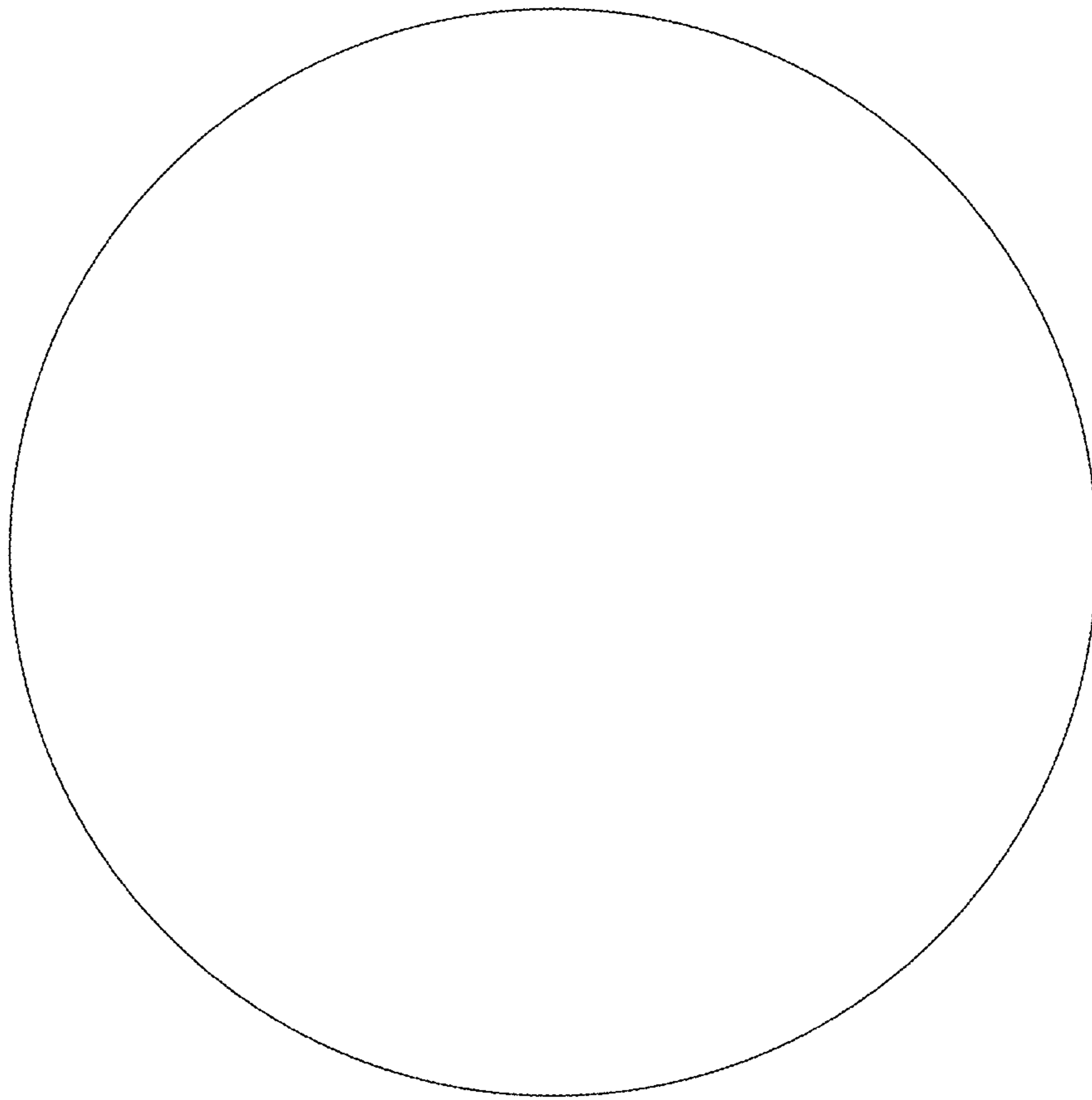

Fig. 11

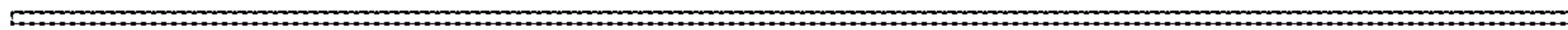

Fig. 12



Fig.13

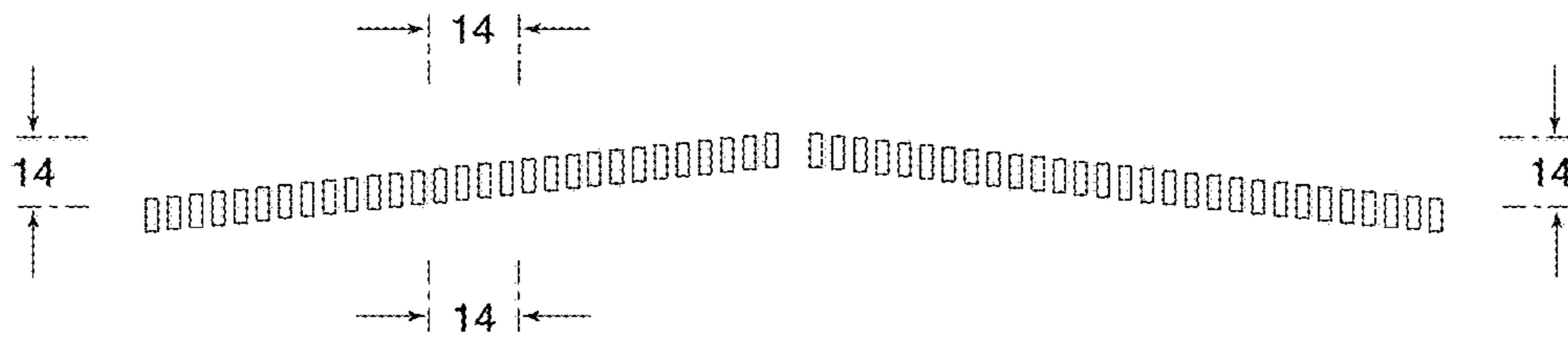

Fig. 14

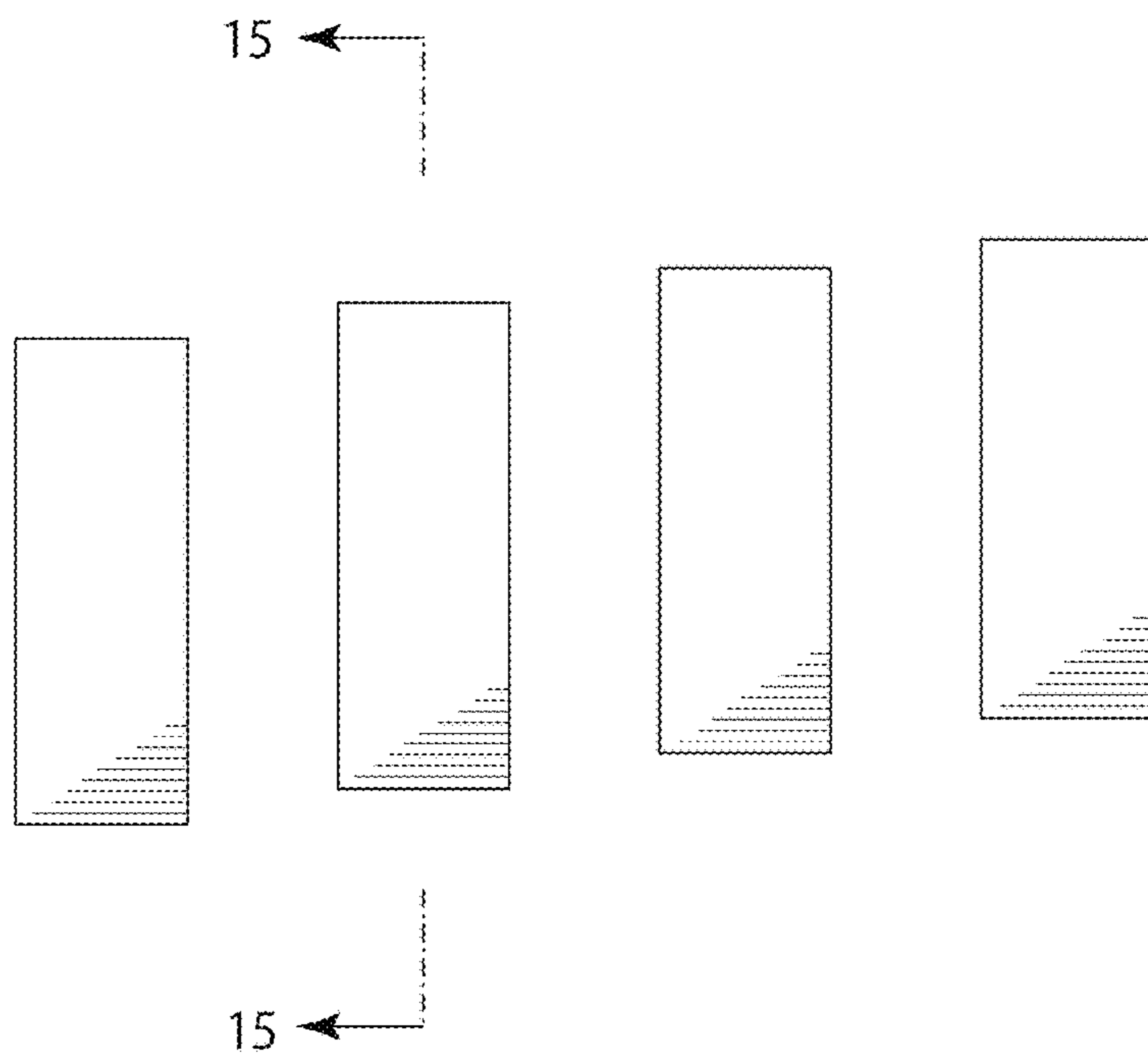



Fig. 15

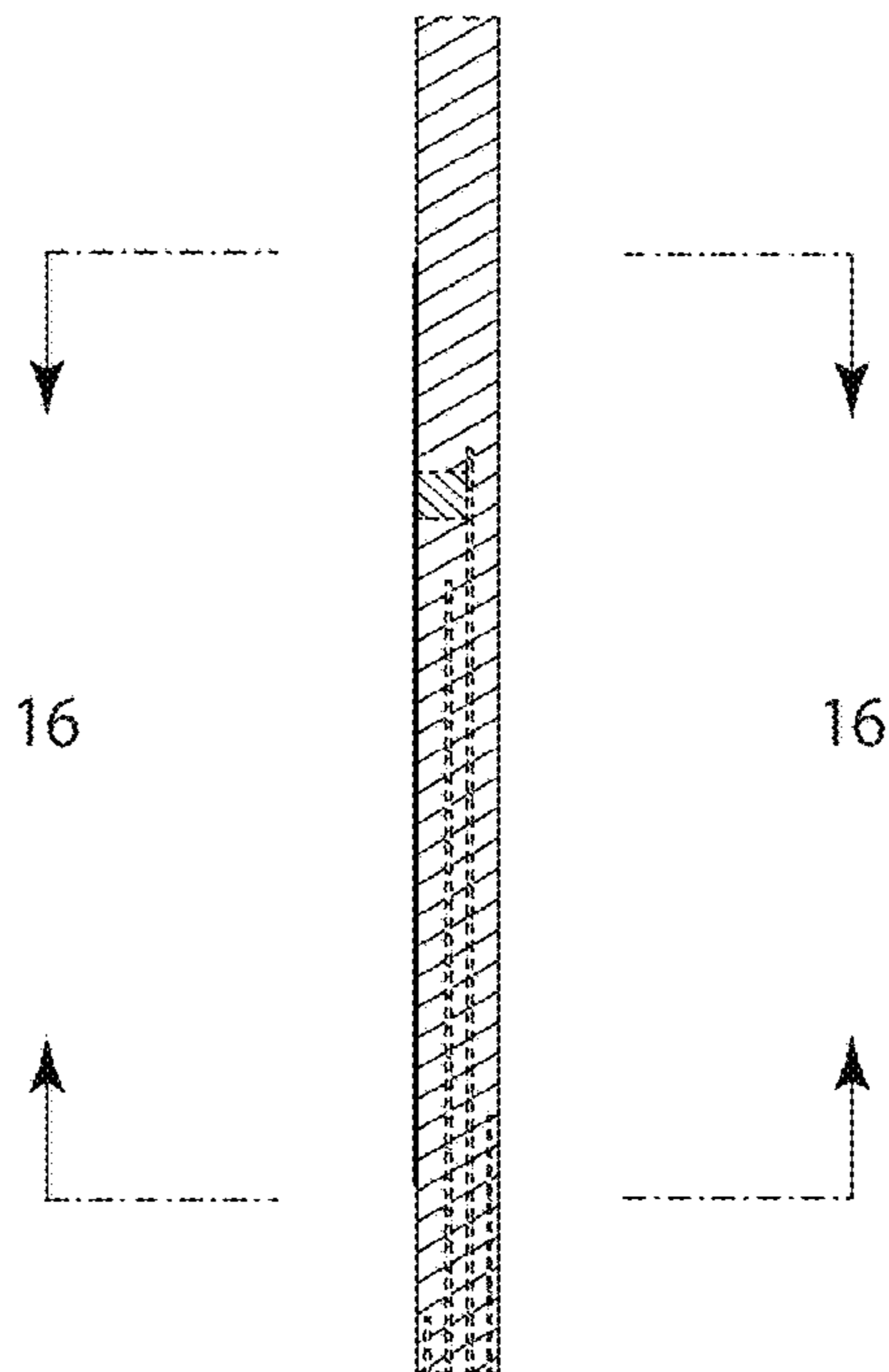

Fig. 16

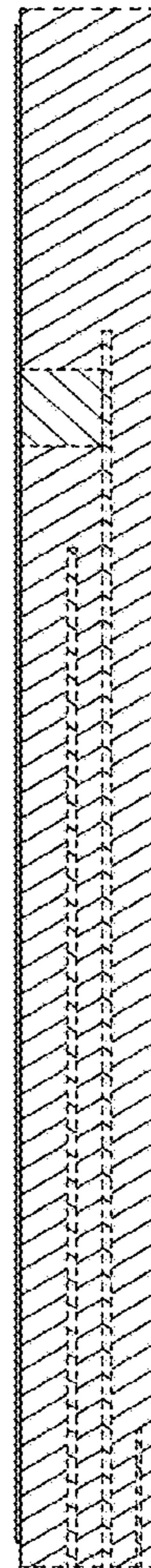

Fig. 17

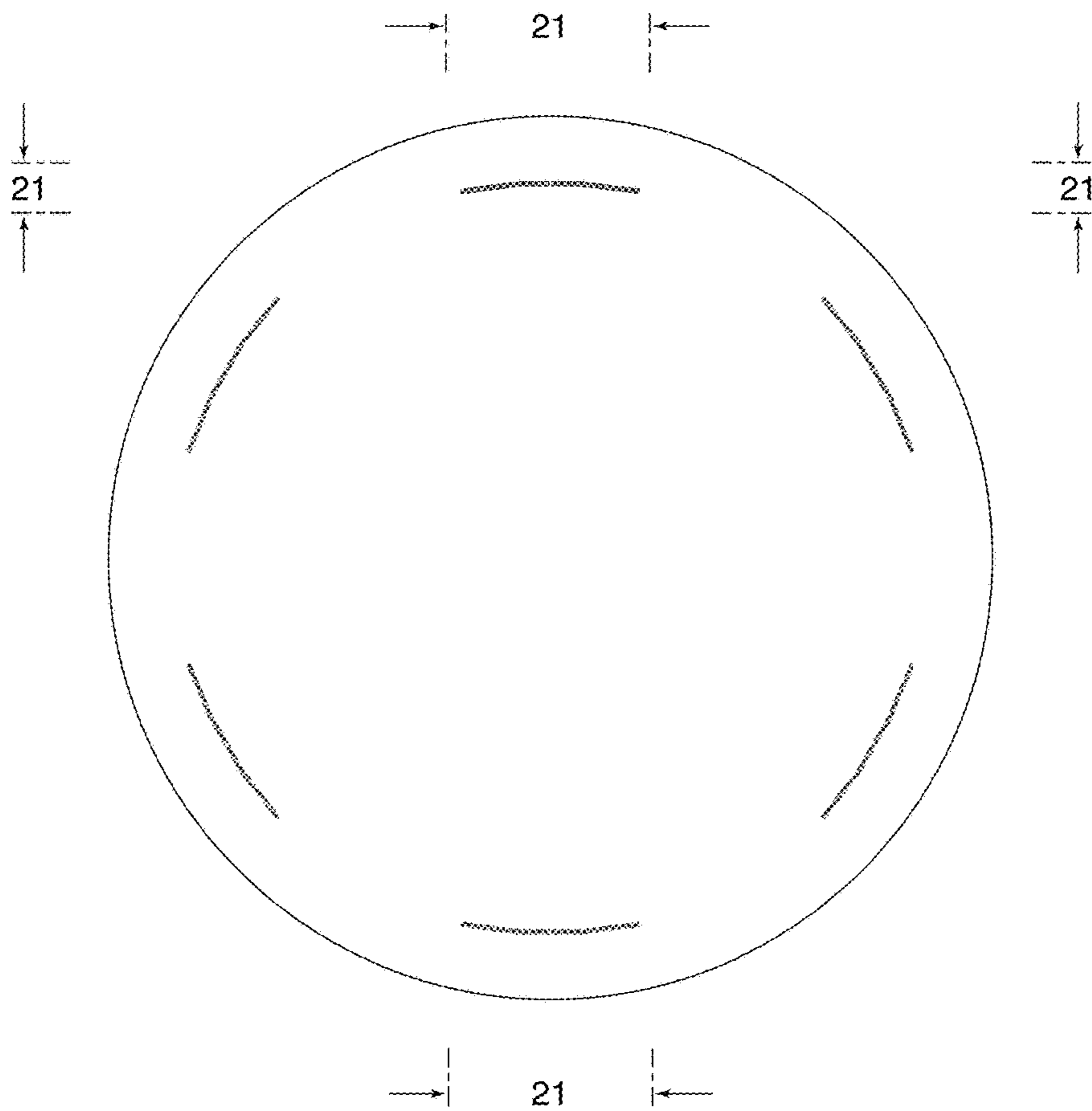

Fig. 18

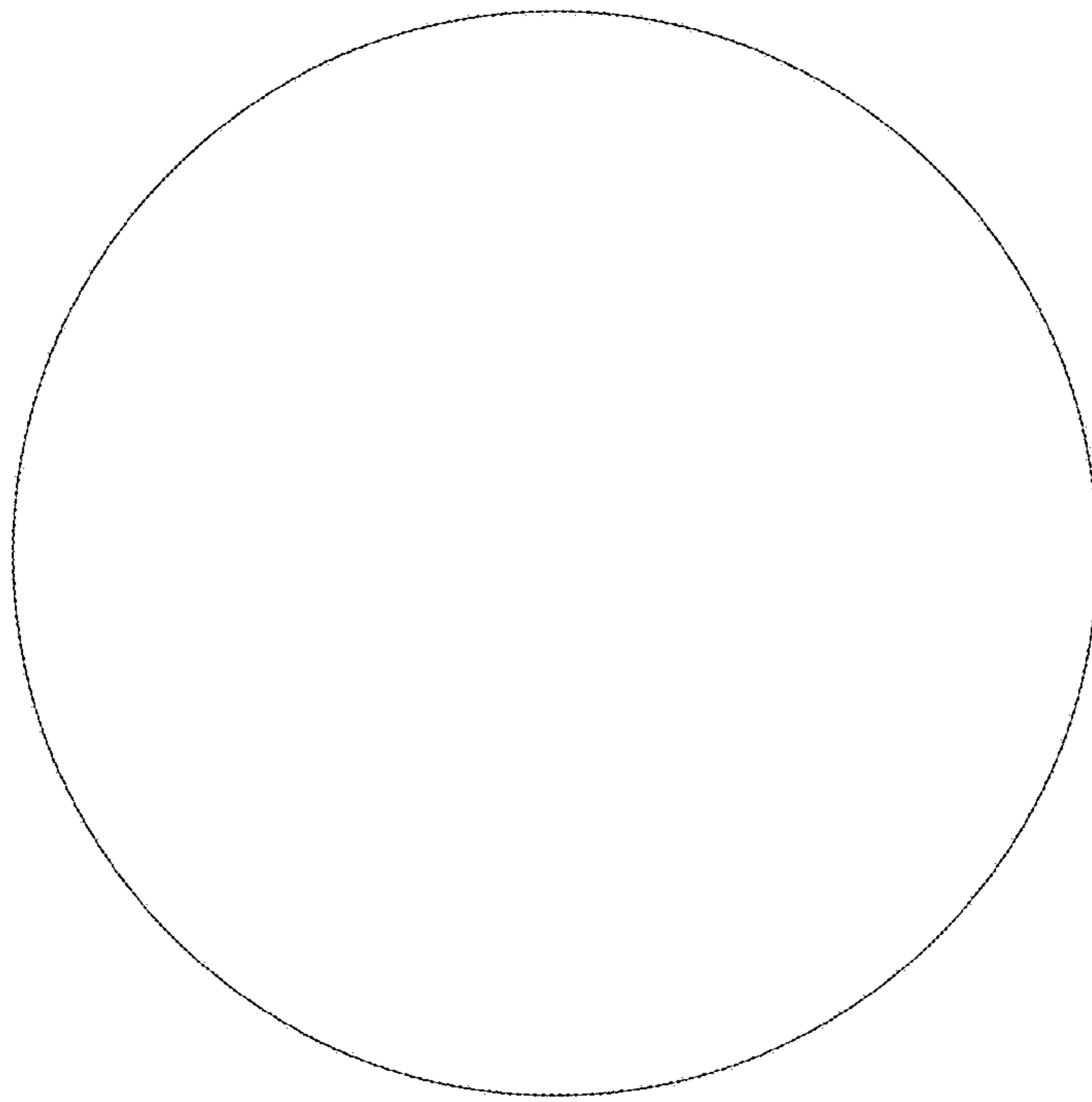

Fig. 19

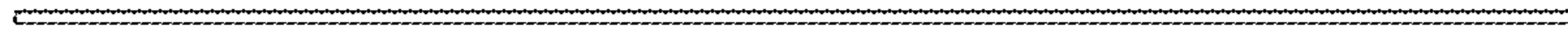

Fig. 20

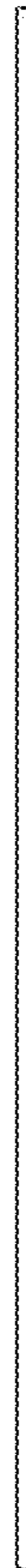

Fig.21

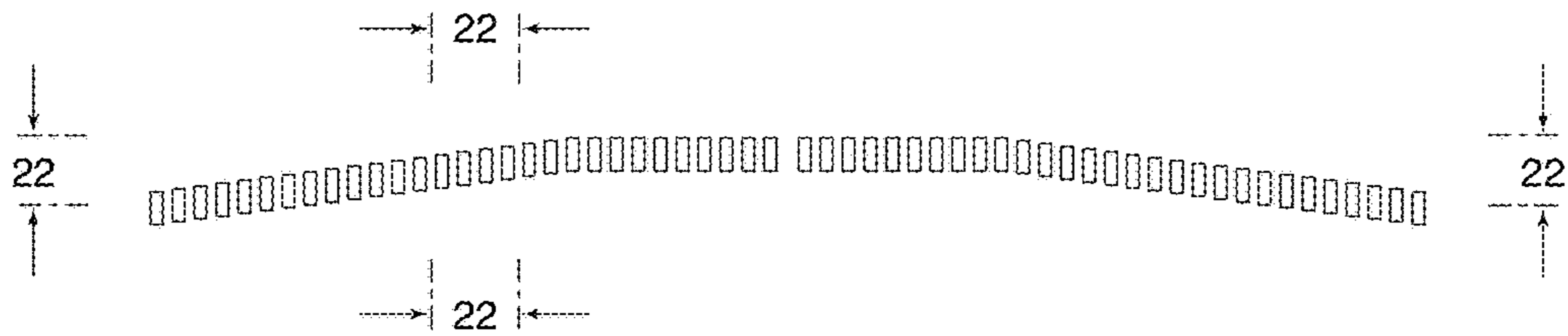

Fig.22

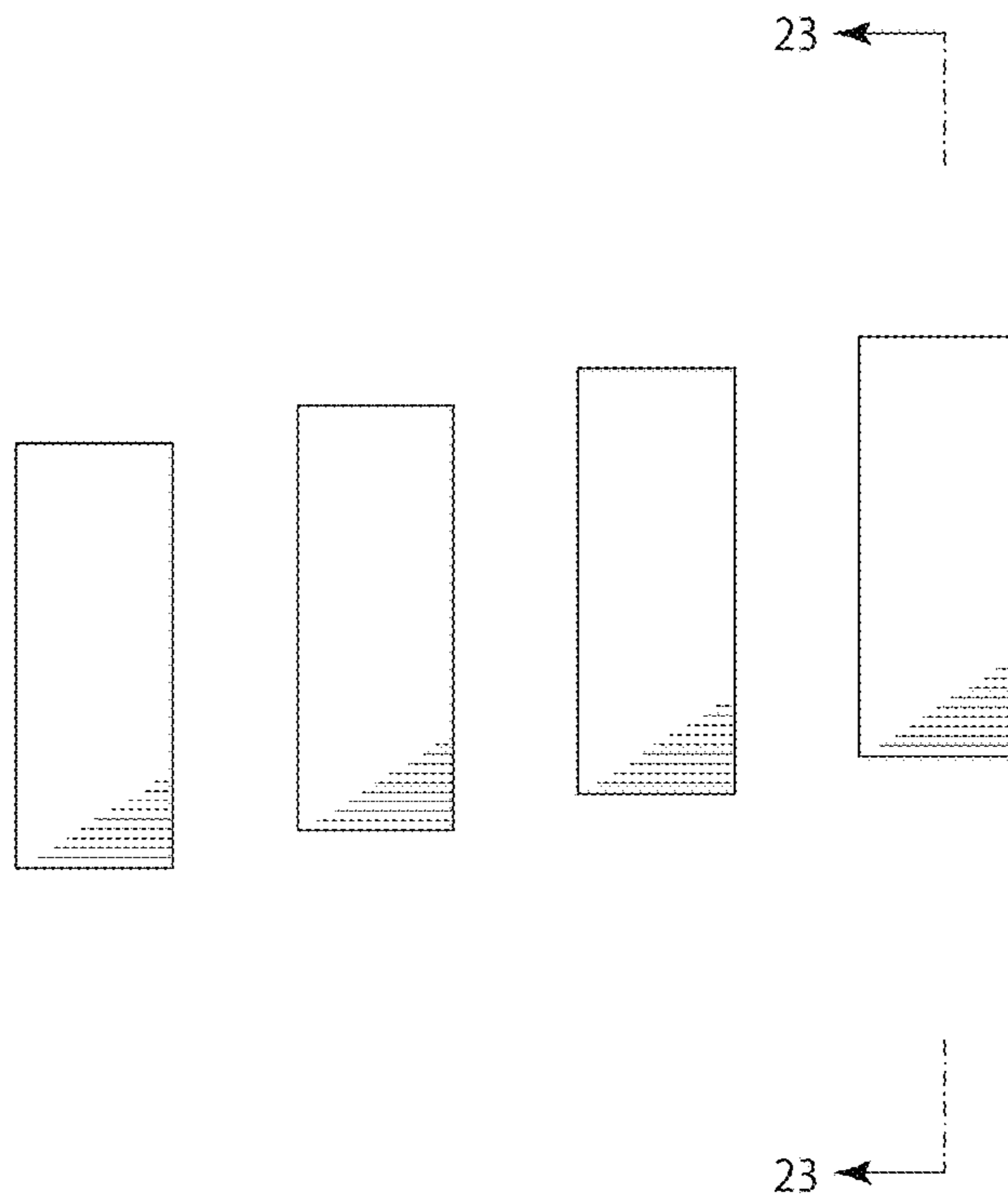



Fig.23

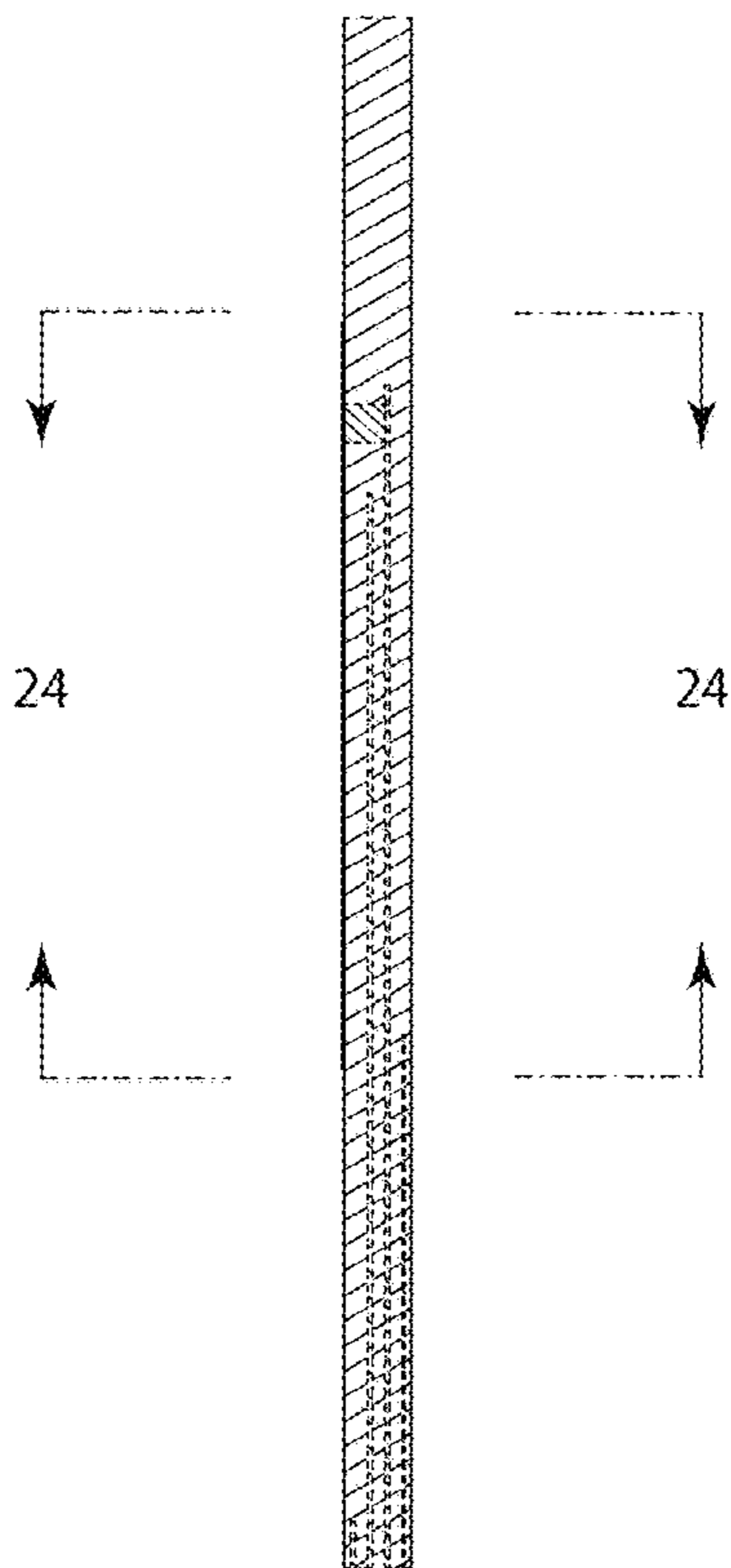

Fig.24

