



US00D846479S

(12) **United States Design Patent**
Hunter et al.

(10) **Patent No.:** **US D846,479 S**
(45) **Date of Patent:** **** Apr. 23, 2019**

- (54) **WATER RIDE VEHICLE**
- (71) Applicant: **ProSlide Technology Inc.**, Ottawa, Ontario (CA)
- (72) Inventors: **Richard D. Hunter**, Ottawa (CA);
Raymond T. Smegal, Ottawa (CA)
- (73) Assignee: **ProSlide Technology Inc.**, Ottawa (CA)
- (**) Term: **15 Years**
- (21) Appl. No.: **29/571,252**
- (22) Filed: **Jul. 15, 2016**
- (51) **LOC (11) Cl.** **12-06**
- (52) **U.S. Cl.**
USPC **D12/316**
- (58) **Field of Classification Search**
USPC D21/542, 544, 547, 646, 760, 761, 762,
D21/764, 769, 770, 771, 778, 792, 801,
(Continued)

(56) **References Cited**

U.S. PATENT DOCUMENTS

- 1,672,473 A * 6/1928 Scheibert B63B 7/08
114/345
- 2,370,069 A * 2/1945 Patten B63B 7/08
114/345

(Continued)

FOREIGN PATENT DOCUMENTS

- CA 2654714 A1 3/2002
- CA 2674329 A1 1/2011

(Continued)

OTHER PUBLICATIONS

“Raft Materials and Manufacturers” [online]. Zachary Collier. [Published Mar. 22, 2013]. Retrieved from the Internet: <<https://www.nwrafting.com/river-equipnment/types-of-rafts>>.*

(Continued)

Primary Examiner — Khawaja Anwar
Assistant Examiner — Mojtaba Tehrani
(74) *Attorney, Agent, or Firm* — Finnegan, Henderson, Farabow, Garrett & Dunner, L.L.P.

(57) **CLAIM**

The ornamental design of a water ride vehicle, as shown and described.

DESCRIPTION

FIG. 1 is a perspective view of the first embodiment of a water ride vehicle, showing our new design;
 FIG. 2 is a top view thereof;
 FIG. 3 is a bottom view thereof;
 FIG. 4 is a left side view thereof;
 FIG. 5 is a right side view thereof;
 FIG. 6 is front view thereof;
 FIG. 7 is a rear view thereof;
 FIG. 8 is a perspective view of the second embodiment of a water ride vehicle, showing our new design;
 FIG. 9 is a top view thereof;
 FIG. 10 is a bottom view thereof;
 FIG. 11 is a left side view thereof;
 FIG. 12 is a right side view thereof;
 FIG. 13 is a front view thereof; and
 FIG. 14 is a rear view thereof.
 FIG. 15 is a perspective view of the third embodiment of a water ride vehicle, showing our new design;
 FIG. 16 a top view thereof;
 FIG. 17 a bottom view thereof;
 FIG. 18 a left side view thereof;
 FIG. 19 a right side view thereof;
 FIG. 20 is a front view thereof;
 FIG. 21 is a rear view thereof;
 FIG. 22 is a perspective view of the fourth embodiment of a water ride vehicle, showing our new design;
 FIG. 23 is a top view thereof;
 FIG. 24 is a bottom view thereof;
 FIG. 25 is a left side view thereof;
 FIG. 26 is a right side view thereof;
 FIG. 27 is a front view thereof; and,
 FIG. 28 is a rear view thereof.

(Continued)

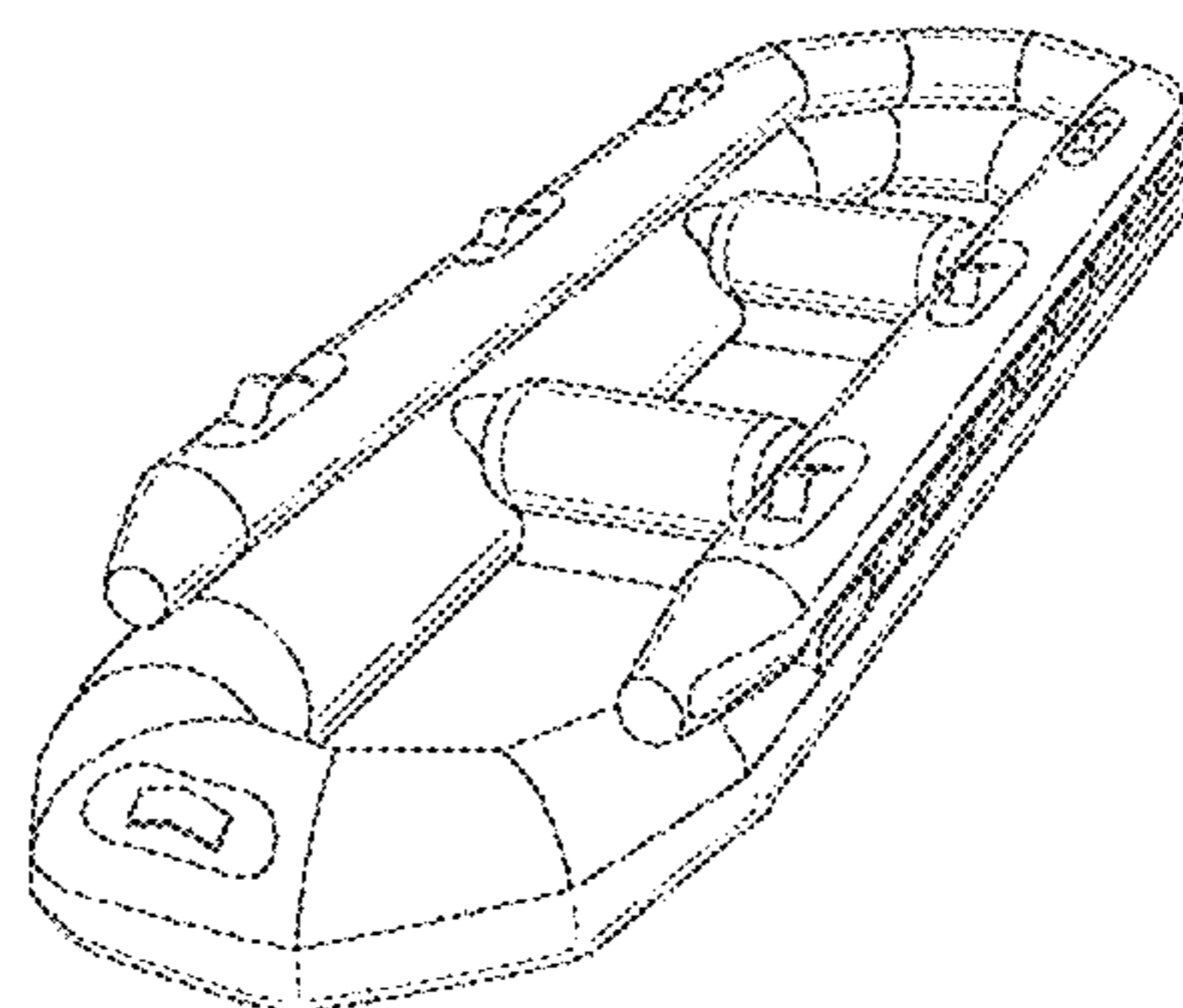
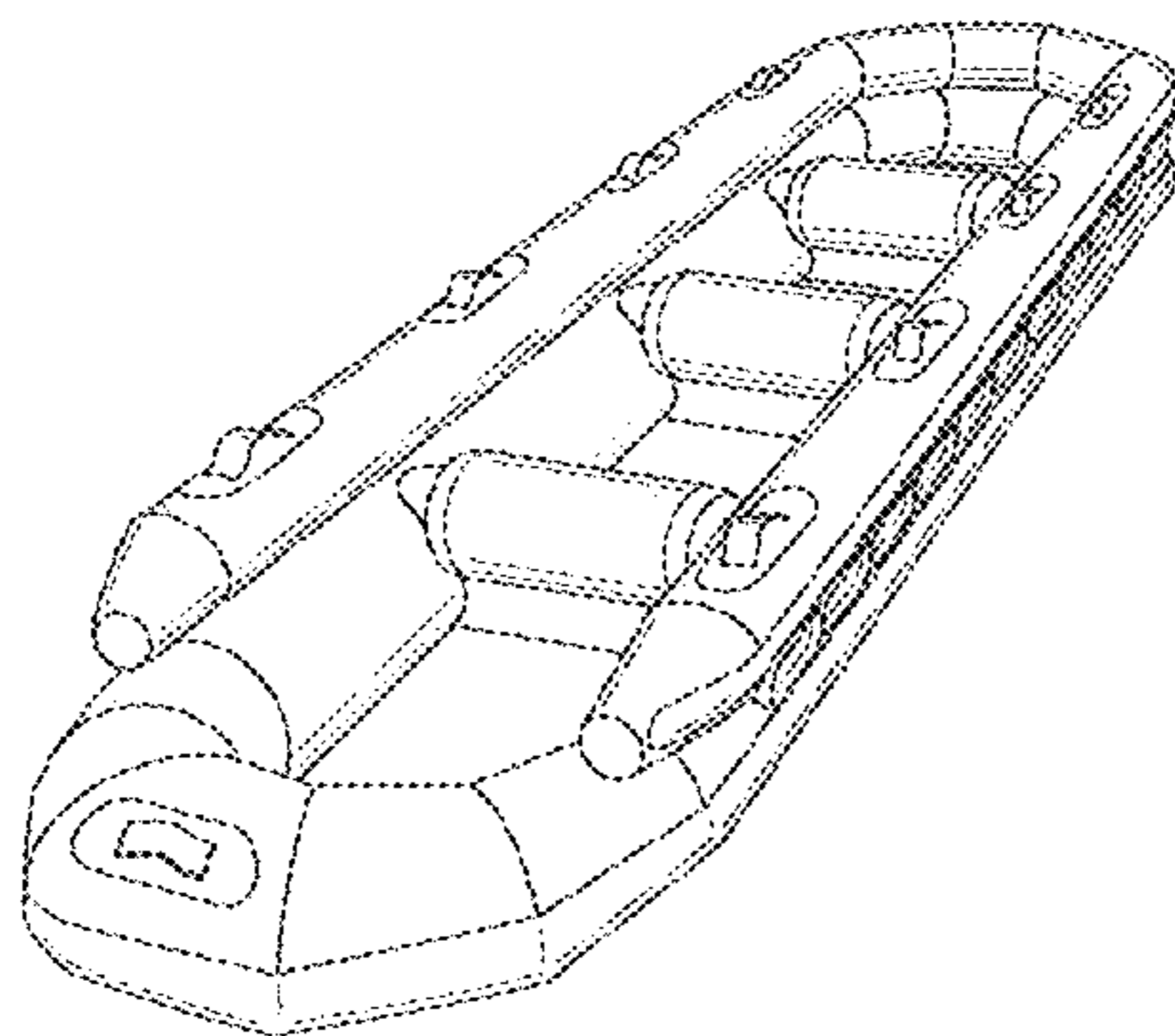

The broken line in the drawings depicts unclaimed portion of the water ride vehicle only and forms no part of the claimed design.

1 Claim, 12 Drawing Sheets

(58) **Field of Classification Search**

USPC D21/803, 804, 805, 806, 807, 808, 810;
D12/301, 302, 303, 306, 310, 311, 312,
D12/313, 314, 316
CPC A41D 13/0518; A63B 2208/03; A63B
2225/605; A63B 31/00; A63B 31/10;
A63B 69/14; A63B 31/11; B63B 21/66;
B63C 11/02

See application file for complete search history.

(56) **References Cited**

U.S. PATENT DOCUMENTS

D151,467 S * 10/1948 Potts et al. 114/345
2,604,055 A 7/1949 Snowden
D154,774 S * 8/1949 Harris et al. 114/345
3,000,022 A 9/1951 Cathey et al.
3,261,038 A * 7/1966 Klepper B63B 7/082
114/345
3,438,074 A 4/1969 Goyen
3,935,607 A * 2/1976 Cantwell B63B 7/08
114/345
4,251,893 A * 2/1981 McCrory B63B 7/08
114/345
4,603,651 A * 8/1986 Harding B63B 7/082
114/345
D300,051 S * 2/1989 Minurri D12/11
4,807,555 A * 2/1989 Hart B63B 7/082
114/345
D301,322 S * 5/1989 Lee D12/11
4,894,033 A * 1/1990 Chang B63B 7/085
440/21
4,942,838 A * 7/1990 Boyer B63B 7/087
114/345
4,945,851 A * 8/1990 Buckle B63B 7/08
114/333
5,031,556 A 6/1991 Blee
D318,454 S * 7/1991 Wannop D12/310
5,131,348 A * 7/1992 Roy B63B 7/082
114/345
5,154,134 A * 10/1992 Goldsmith B63B 7/085
114/345
D334,912 S * 4/1993 Harman D12/316
5,213,547 A 5/1993 Lochtefeld
5,219,315 A 6/1993 Fuller et al.
5,228,407 A * 7/1993 Cummer B63B 7/082
114/345
5,290,196 A * 3/1994 Steel B63B 35/74
441/130
5,421,757 A * 6/1995 Basiliere B63C 9/04
441/128
D362,475 S * 9/1995 Berres D12/316
D366,303 S * 1/1996 Polley D12/316
5,503,597 A 4/1996 Lochtefeld
5,527,646 A 6/1996 Ogino et al.
5,564,357 A * 10/1996 Peterson B63B 7/085
114/345
5,651,328 A * 7/1997 Elkington B63B 7/082
114/345
5,716,282 A 2/1998 Ring
5,738,590 A 4/1998 Lochtefeld
5,960,734 A * 10/1999 Monlezun F16B 3/005
114/345
6,006,672 A 12/1999 Newfarmer et al.
6,435,927 B1 8/2002 Fireman

6,520,107 B1 * 2/2003 Hickok B63B 1/04
114/355
6,527,646 B1 3/2003 Briggs
6,561,914 B2 5/2003 Henry
6,702,687 B1 3/2004 Henry
6,743,108 B2 6/2004 Hunter
6,758,231 B1 7/2004 Lochtefeld et al.
D505,653 S * 5/2005 Watling D12/316
D505,907 S * 6/2005 Bryham D12/300
7,229,359 B2 6/2007 Henry
7,285,053 B2 10/2007 Henry et al.
7,497,784 B2 3/2009 Henry
7,727,077 B2 6/2010 Henry et al.
7,731,595 B2 6/2010 Hlynka
7,740,542 B2 6/2010 Henry et al.
7,758,435 B2 7/2010 Henry et al.
7,758,535 B2 7/2010 Levine et al.
7,762,900 B2 7/2010 Henry et al.
7,766,753 B2 8/2010 Henry et al.
7,775,172 B2 * 8/2010 Hansen B63B 1/16
114/123
7,785,207 B2 8/2010 Henry et al.
D633,851 S * 3/2011 Scadden D12/304
7,942,752 B2 5/2011 Henry
7,967,692 B2 6/2011 Werner
8,070,616 B2 12/2011 Dubois et al.
8,075,413 B2 12/2011 Henry et al.
8,079,916 B2 12/2011 Henry
8,197,353 B2 6/2012 Brassard
8,210,954 B2 7/2012 Henry et al.
8,282,497 B2 10/2012 Henry et al.
8,286,573 B2 * 10/2012 Hoge, Jr. B63B 7/08
114/140
8,360,895 B2 1/2013 Brown
8,453,579 B2 6/2013 Nemeth
8,579,715 B2 11/2013 Olive et al.
D718,211 S * 11/2014 Kristinsson D12/317
D718,400 S * 11/2014 Swift D12/316
2004/0137808 A1 * 7/2004 Franchetti B63B 7/085
441/40
2006/0096517 A1 * 5/2006 Durand B63B 7/082
114/345
2010/0160054 A1 6/2010 Henry
2012/0201605 A1 8/2012 Hill
2012/0258812 A1 10/2012 Osterman et al.
2013/0184087 A1 7/2013 Degirmenci
2016/0136527 A1 5/2016 Hunter
2017/0043264 A1 2/2017 Hunter et al.
2017/0106295 A1 4/2017 Hunter

FOREIGN PATENT DOCUMENTS

CA 2778601 A1 5/2011
CA 2690687 A1 6/2011
CN 2905159 5/2007
CN 101417179 A 4/2009
JP H-03258280 11/1991
WO WO 88/05745 A1 8/1988
WO WO 2012/048016 A2 4/2012
WO WO 2013/000090 A1 1/2013
WO WO 2014/059551 A1 4/2014
WO WO 2015/161382 A1 10/2015
WO WO 2015/188265 12/2015

OTHER PUBLICATIONS

“4 foot whitewater raft comparison shootout” [online]. Luke Baugh. [Published Jan. 16, 2018]. Retrieved from the Internet: <<https://triadrivertours.com/river-research/2018/1/16/14-foot-whitewater-raft-comparison-shootout>>.*
“ProSlide Hybrid: FlyingSAUCER/ RocketBLAST” [online]. ProSlide Technology. [Published Jul. 30, 2015]. Retrieved from the Internet: <<https://www.youtube.com/watch?v=4lou4Grp938>>.*

* cited by examiner

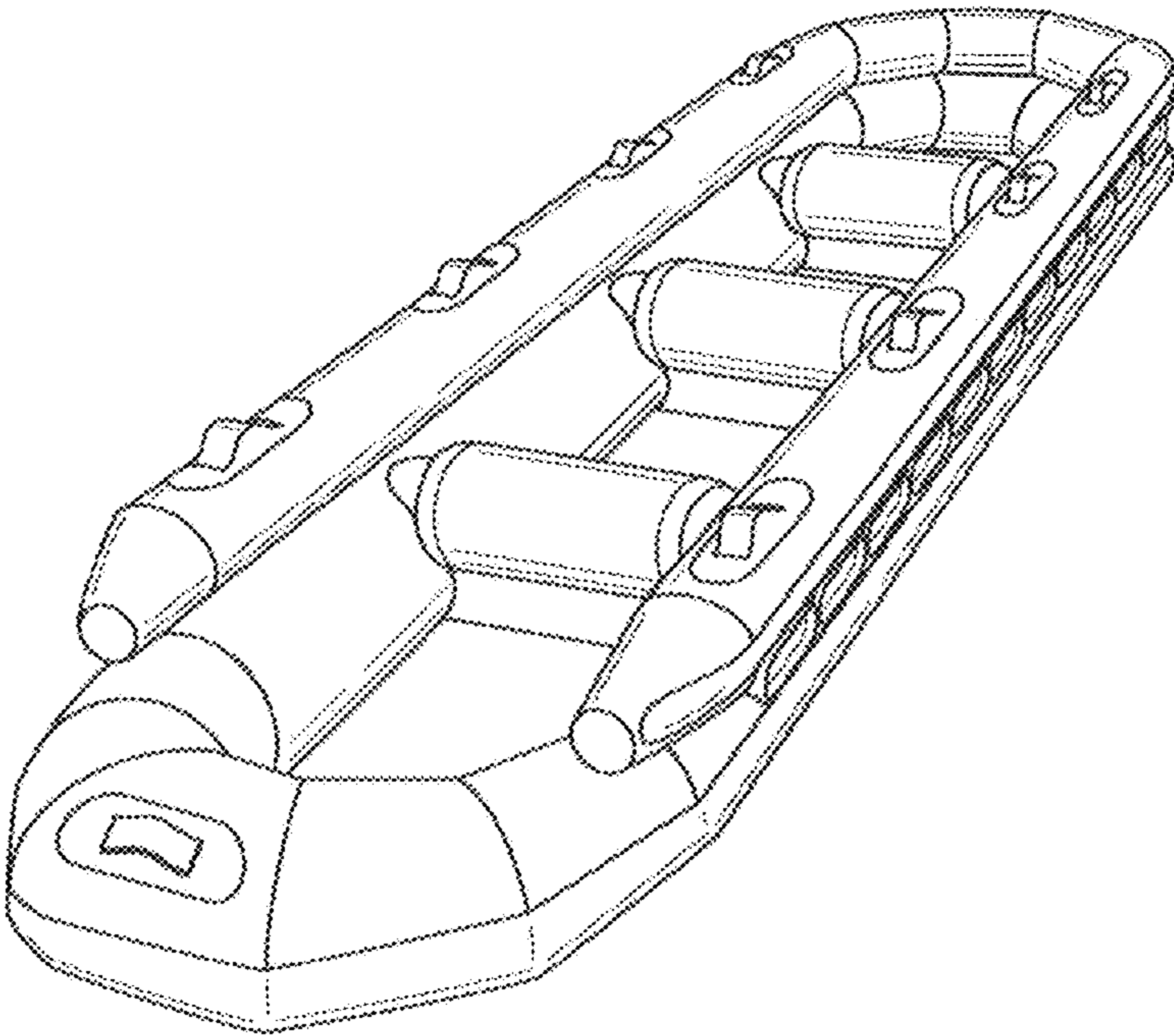

FIG. 1

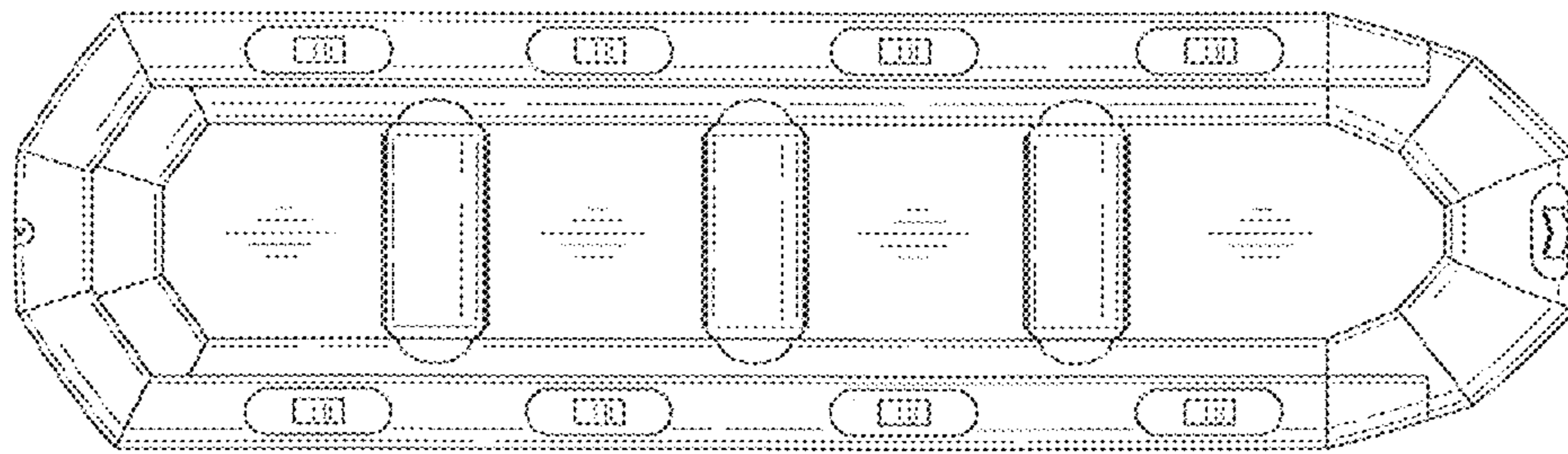

FIG. 2

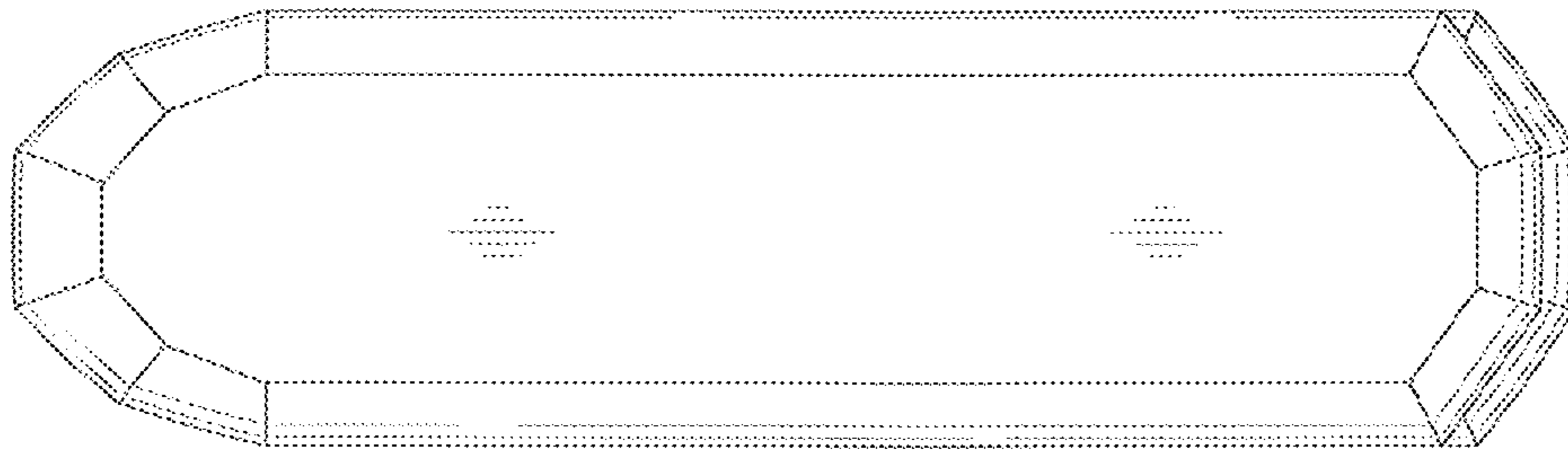

FIG. 3

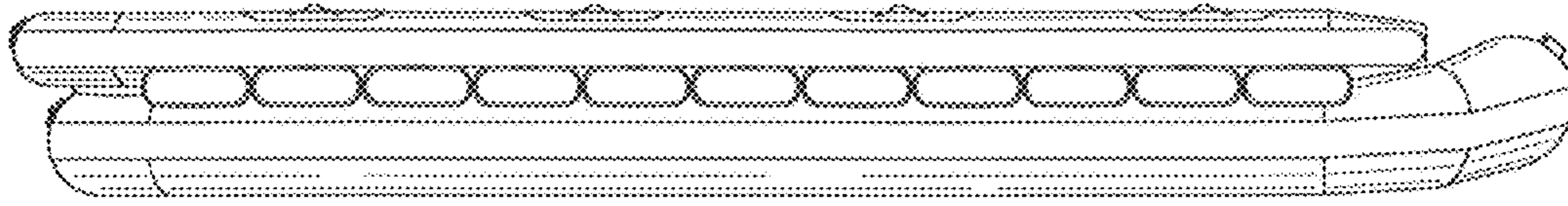

FIG. 4

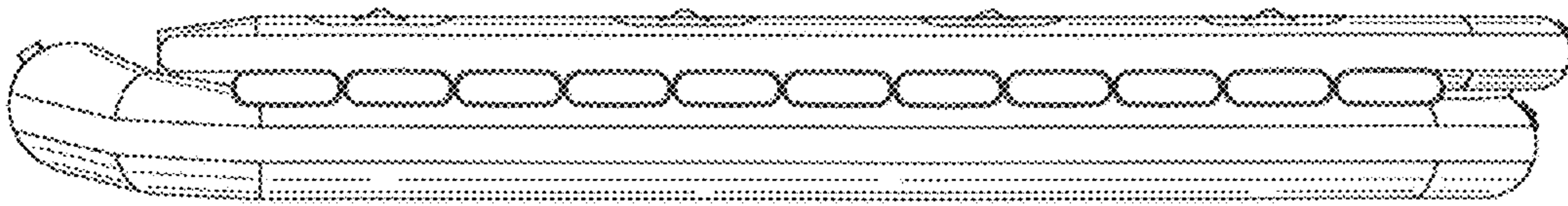

FIG. 5

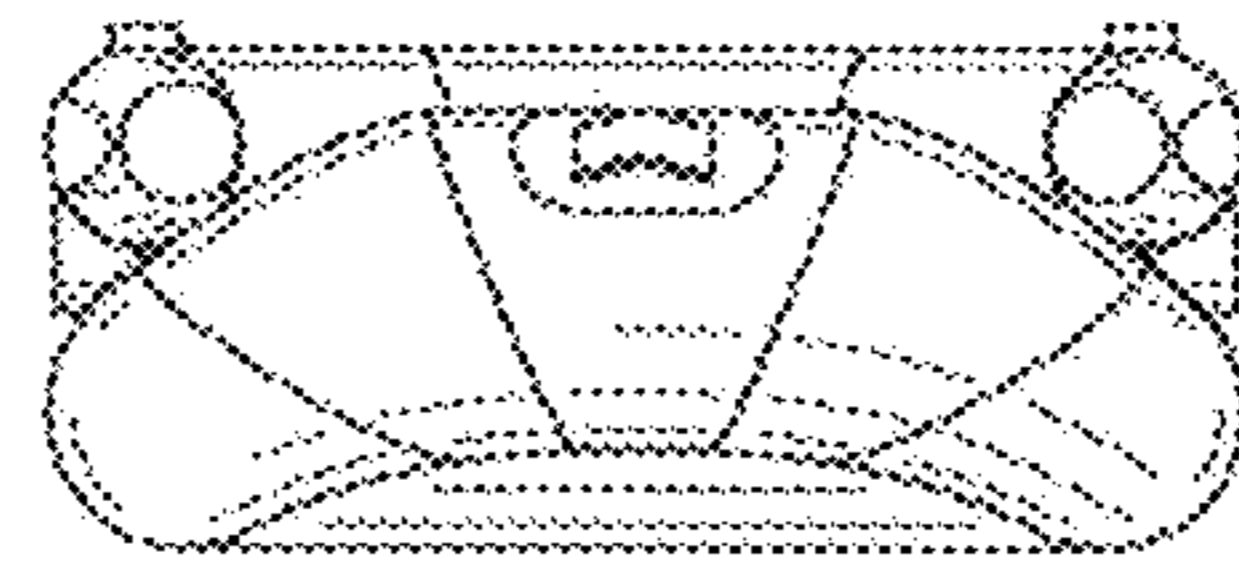

FIG. 6

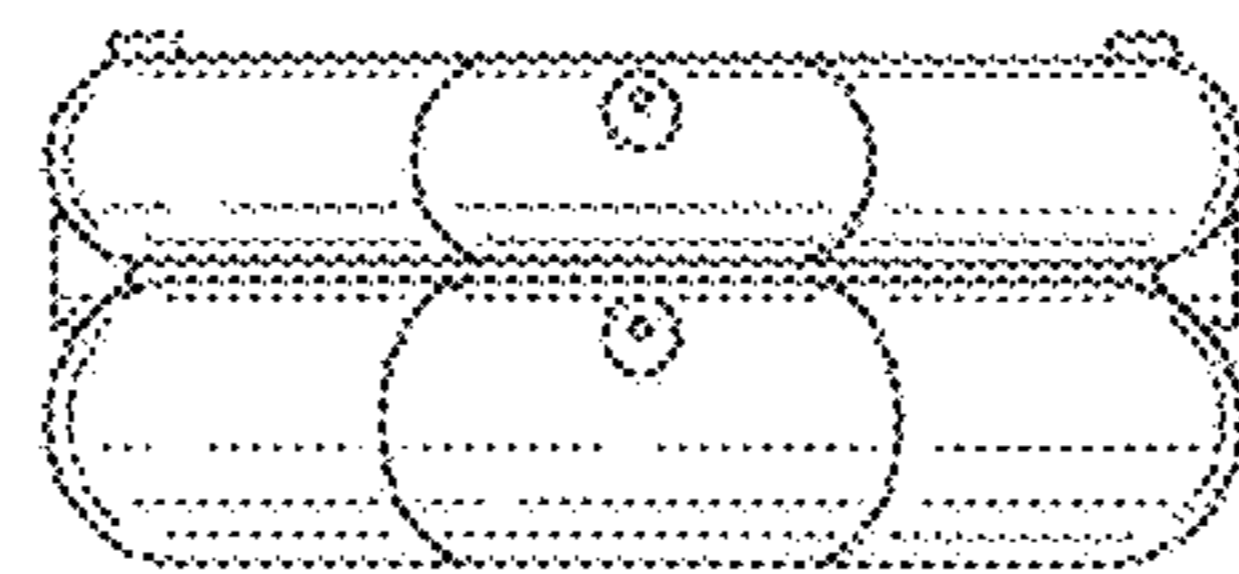

FIG. 7

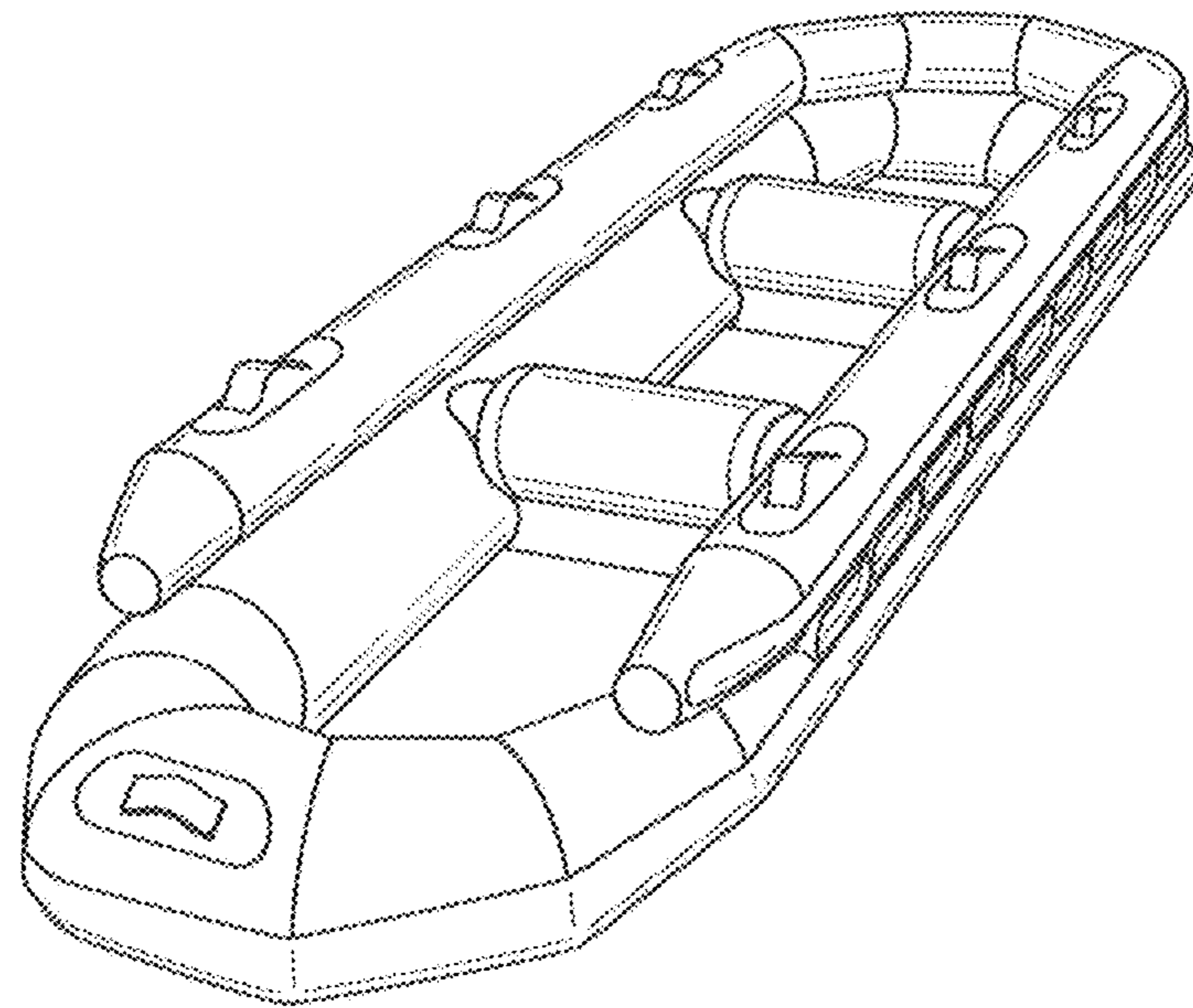

FIG. 8

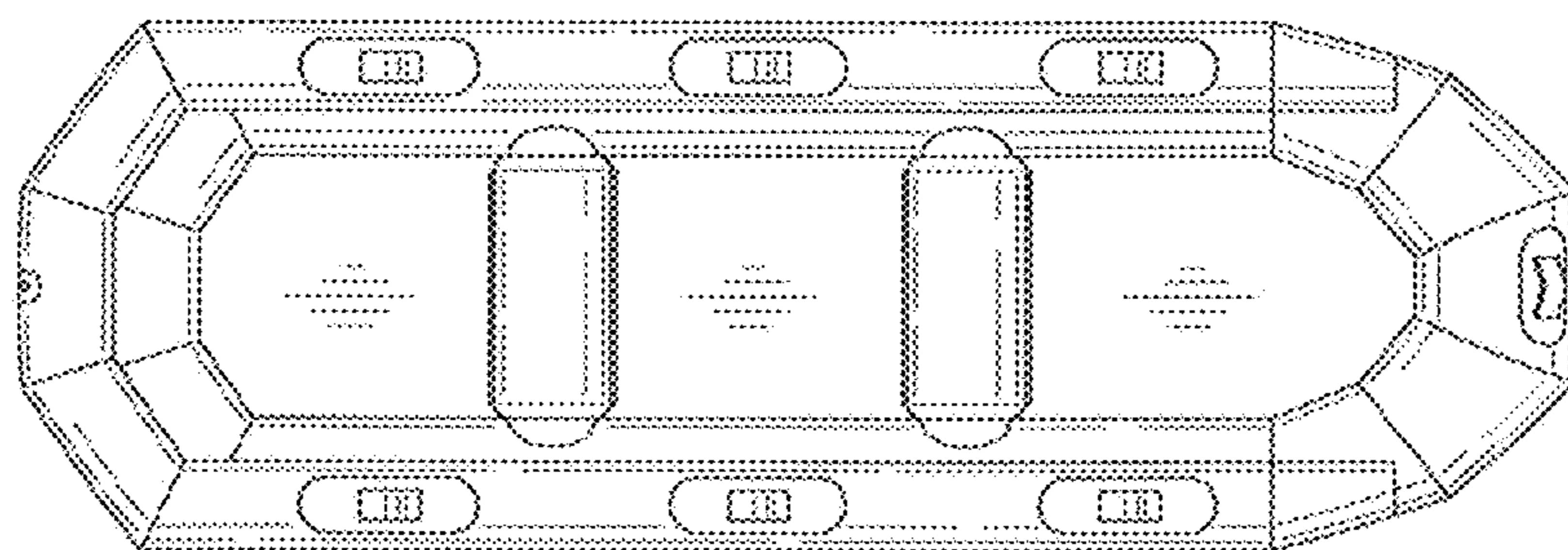

FIG. 9

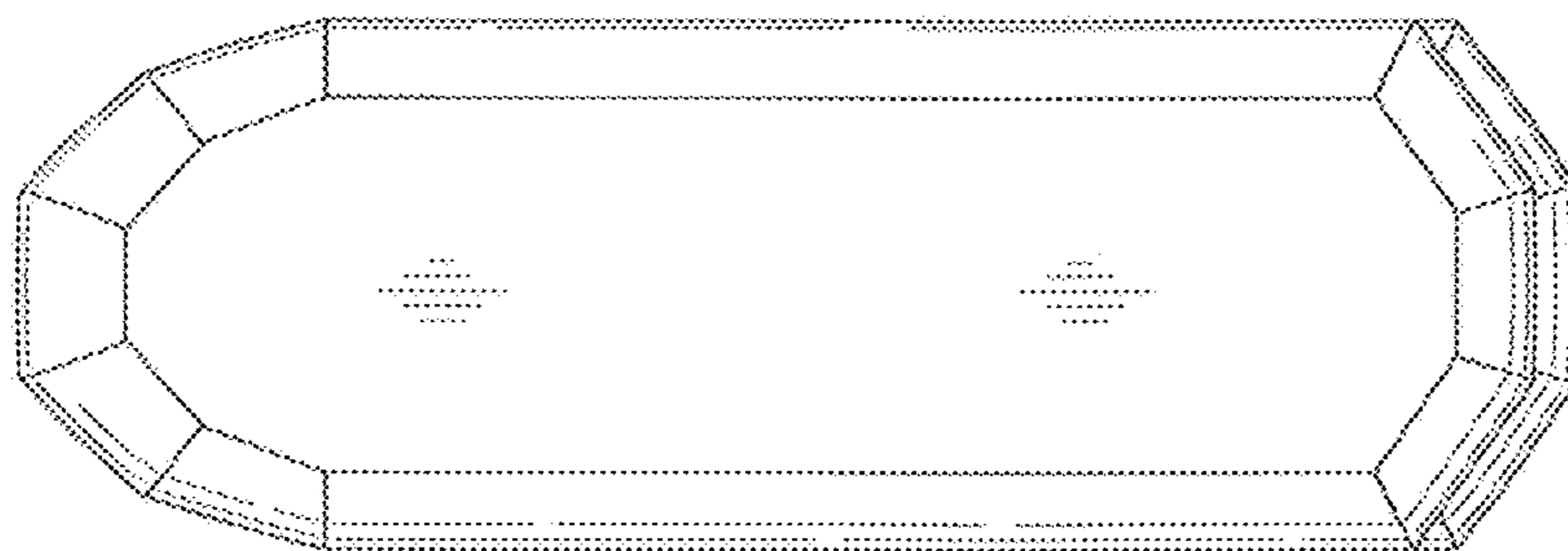

FIG. 10

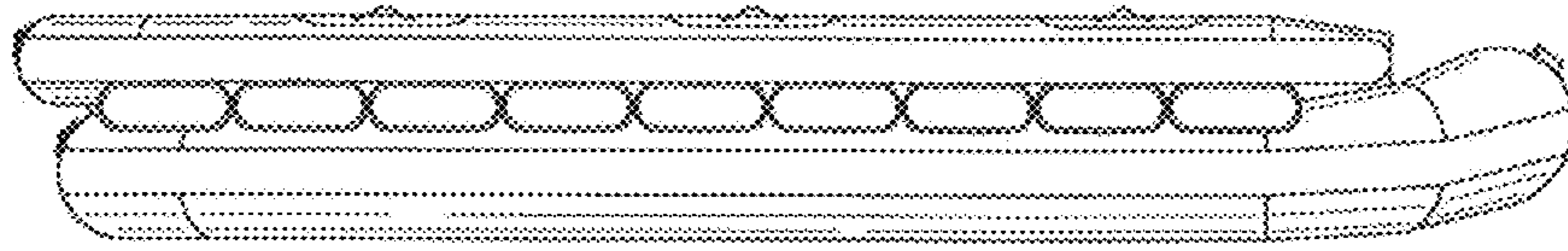

FIG. 11

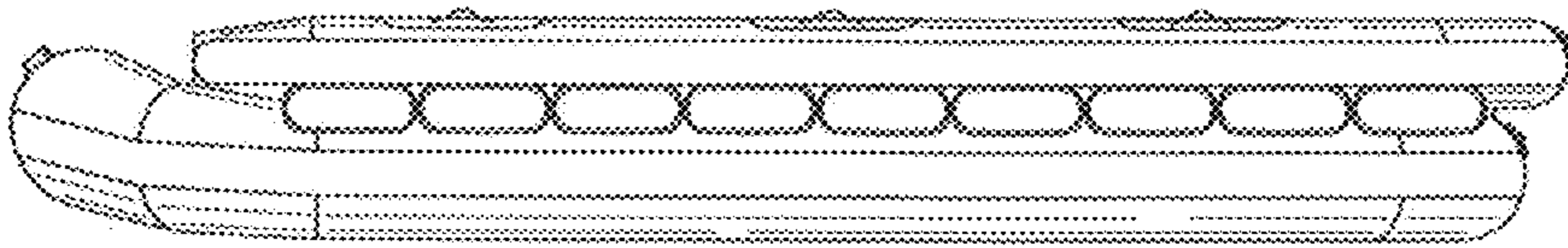

FIG. 12

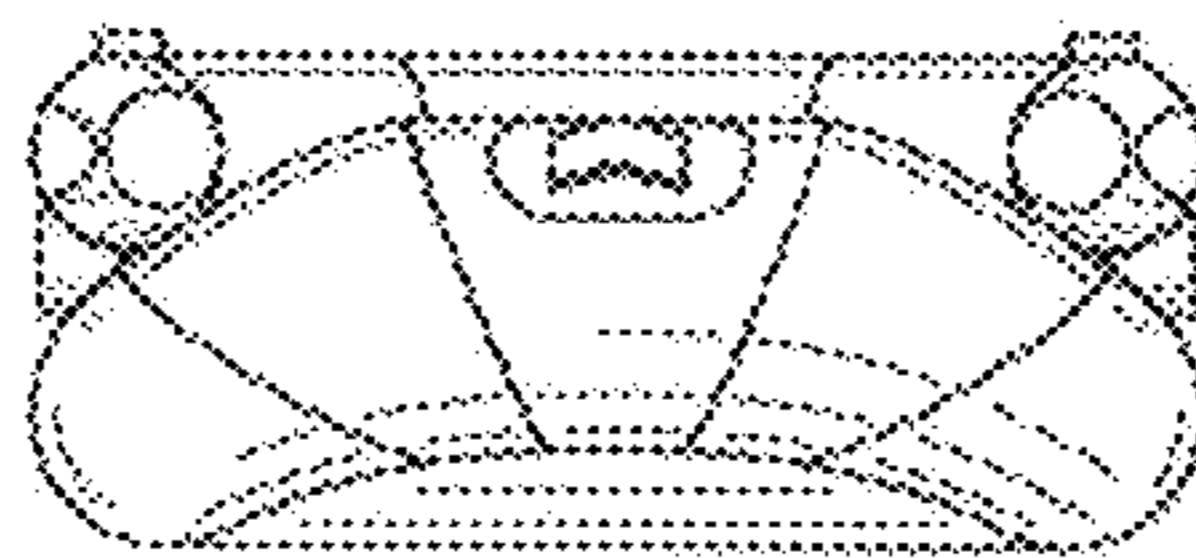

FIG. 13

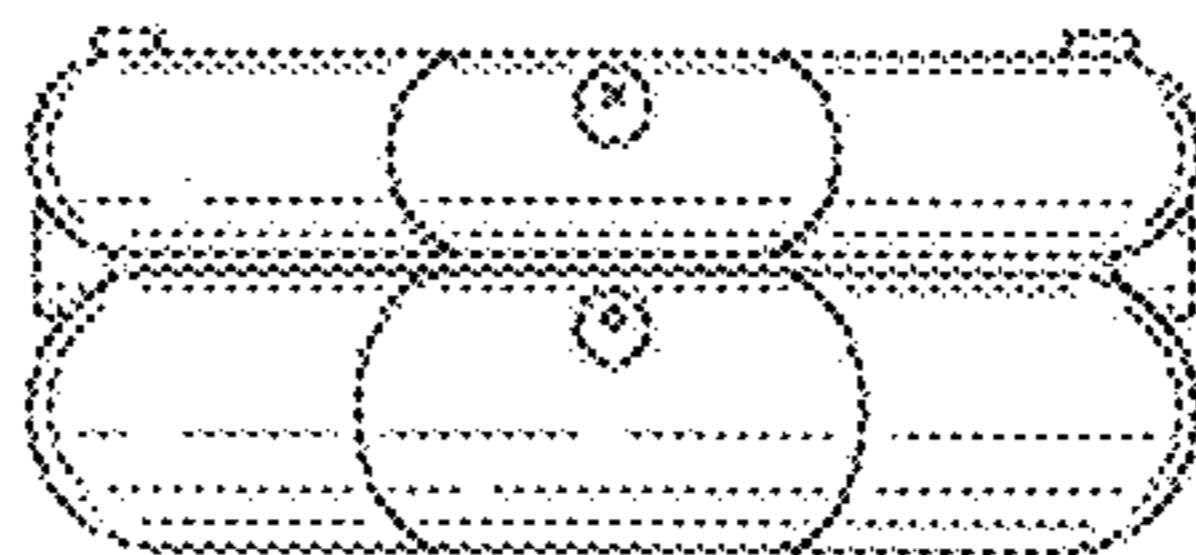

FIG. 14

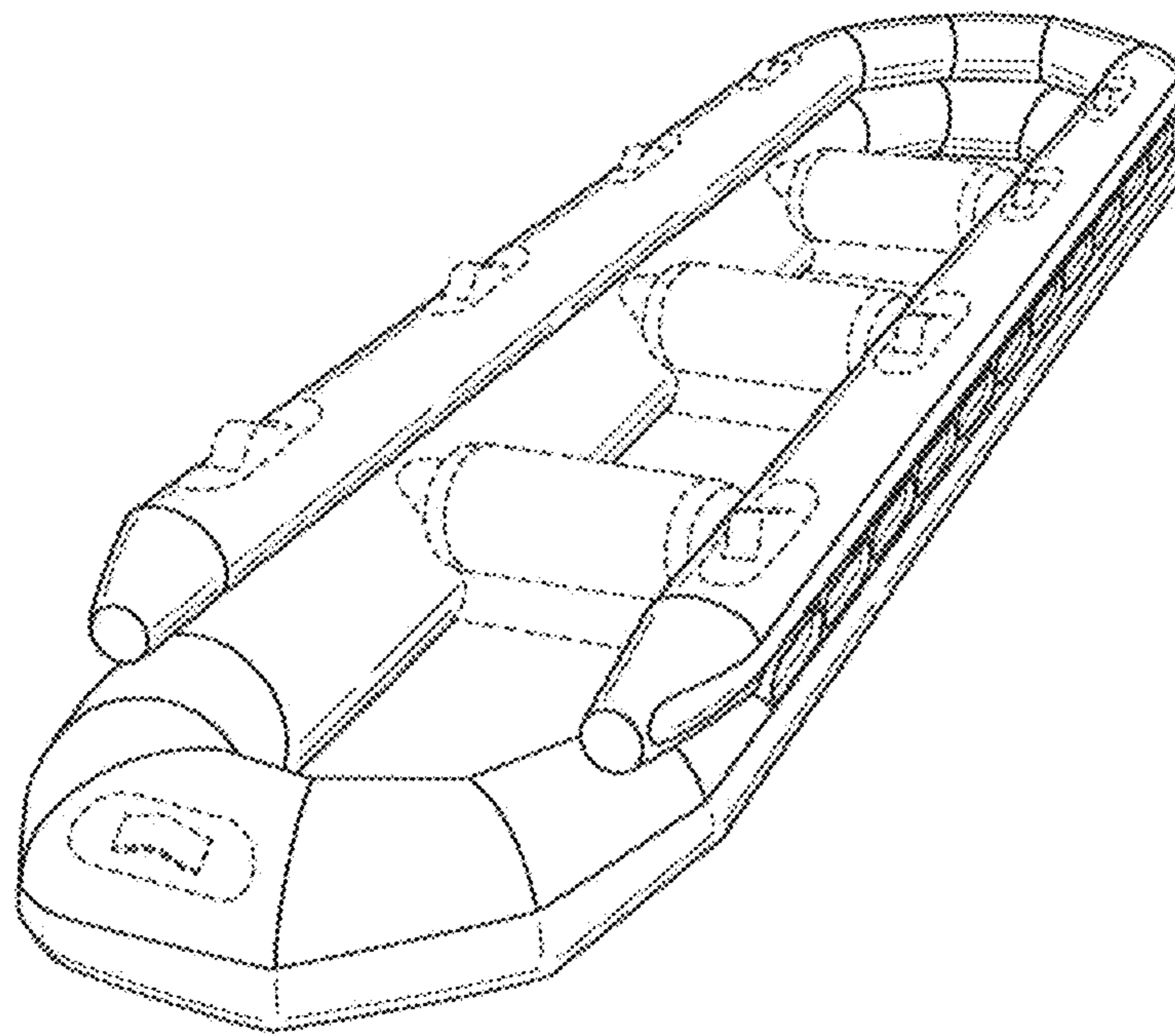

FIG. 15

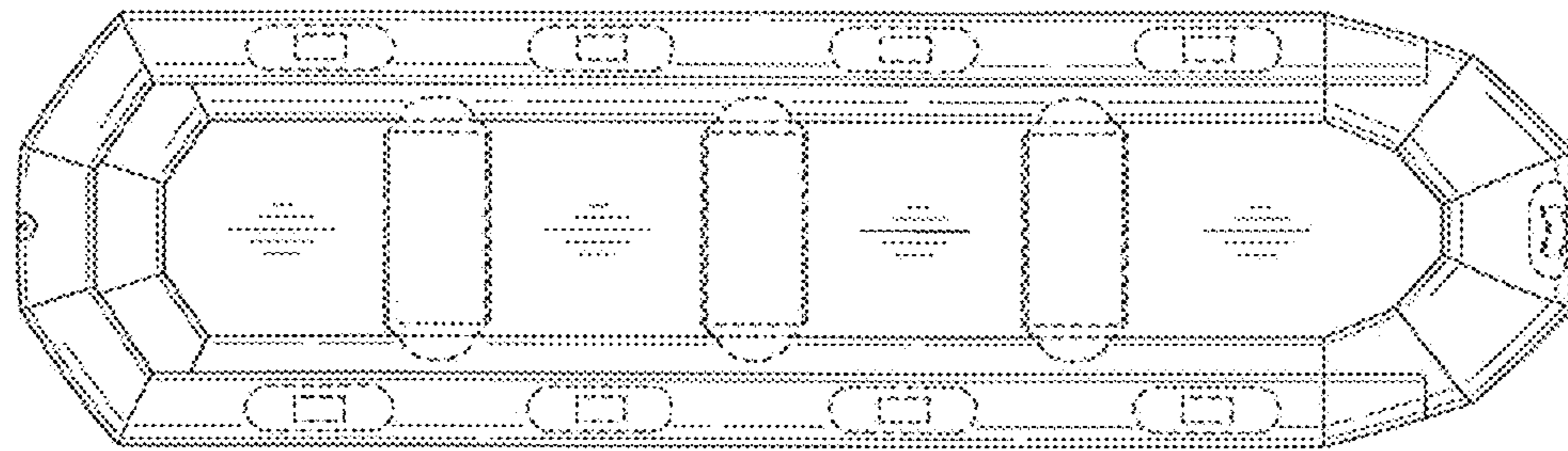

FIG. 16

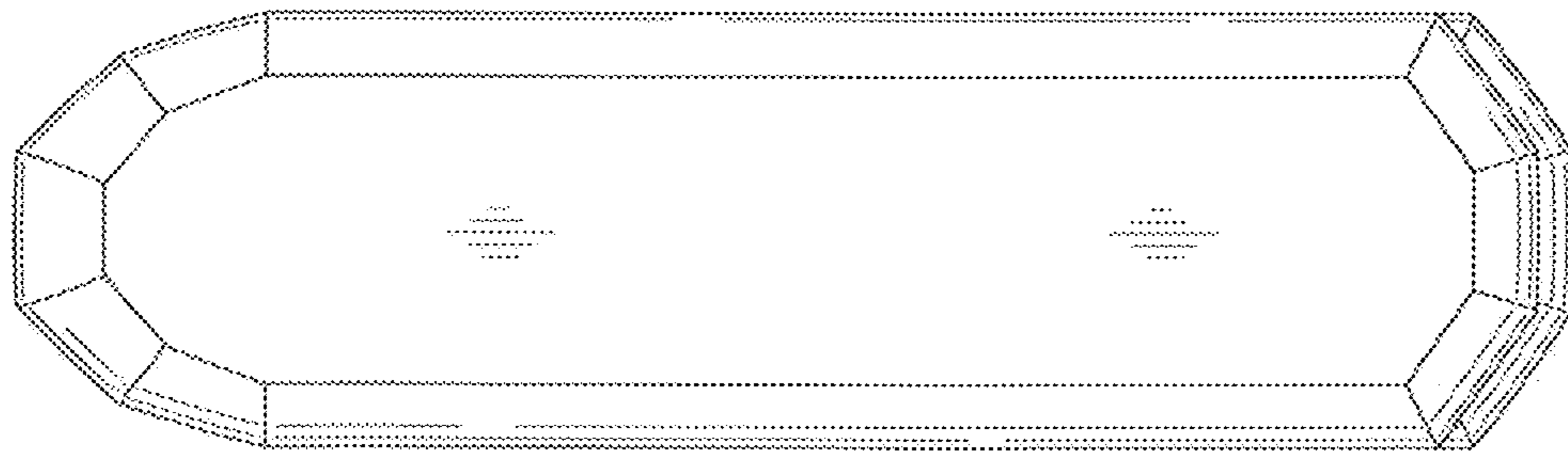

FIG. 17

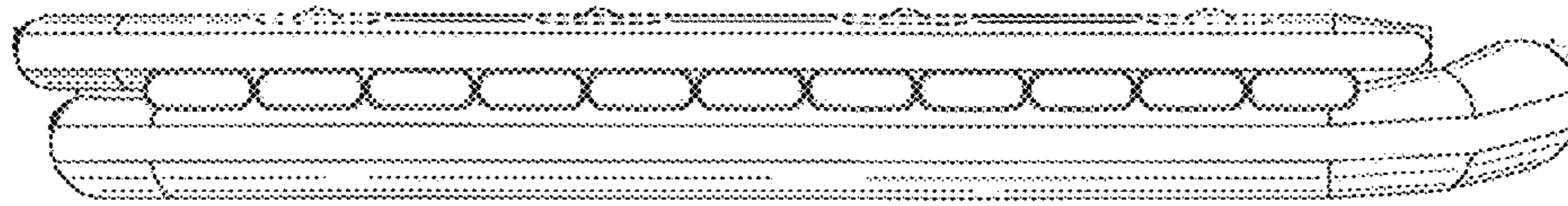

FIG. 18

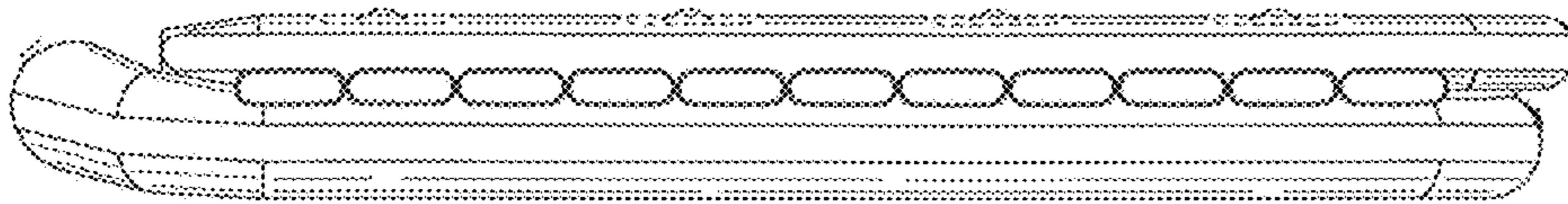

FIG. 19



FIG. 20

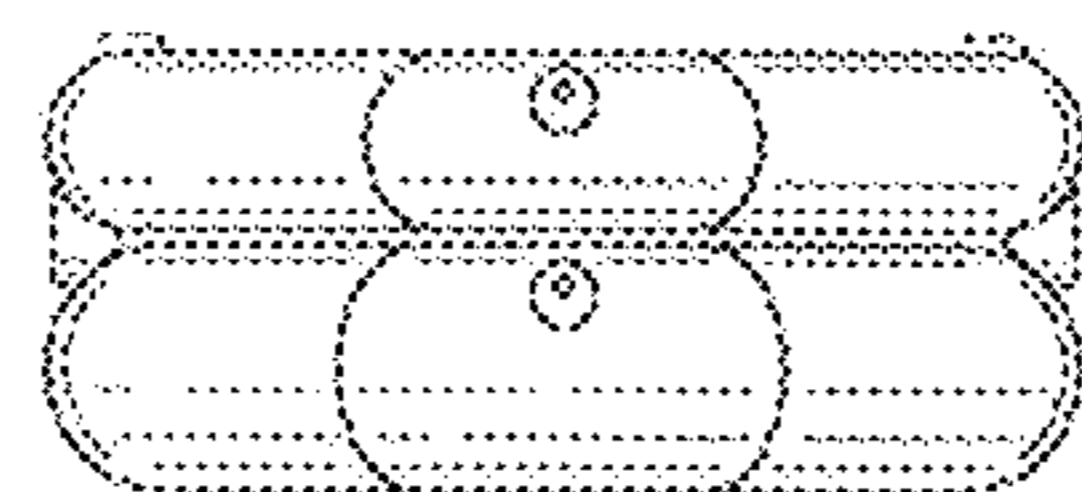

FIG. 21

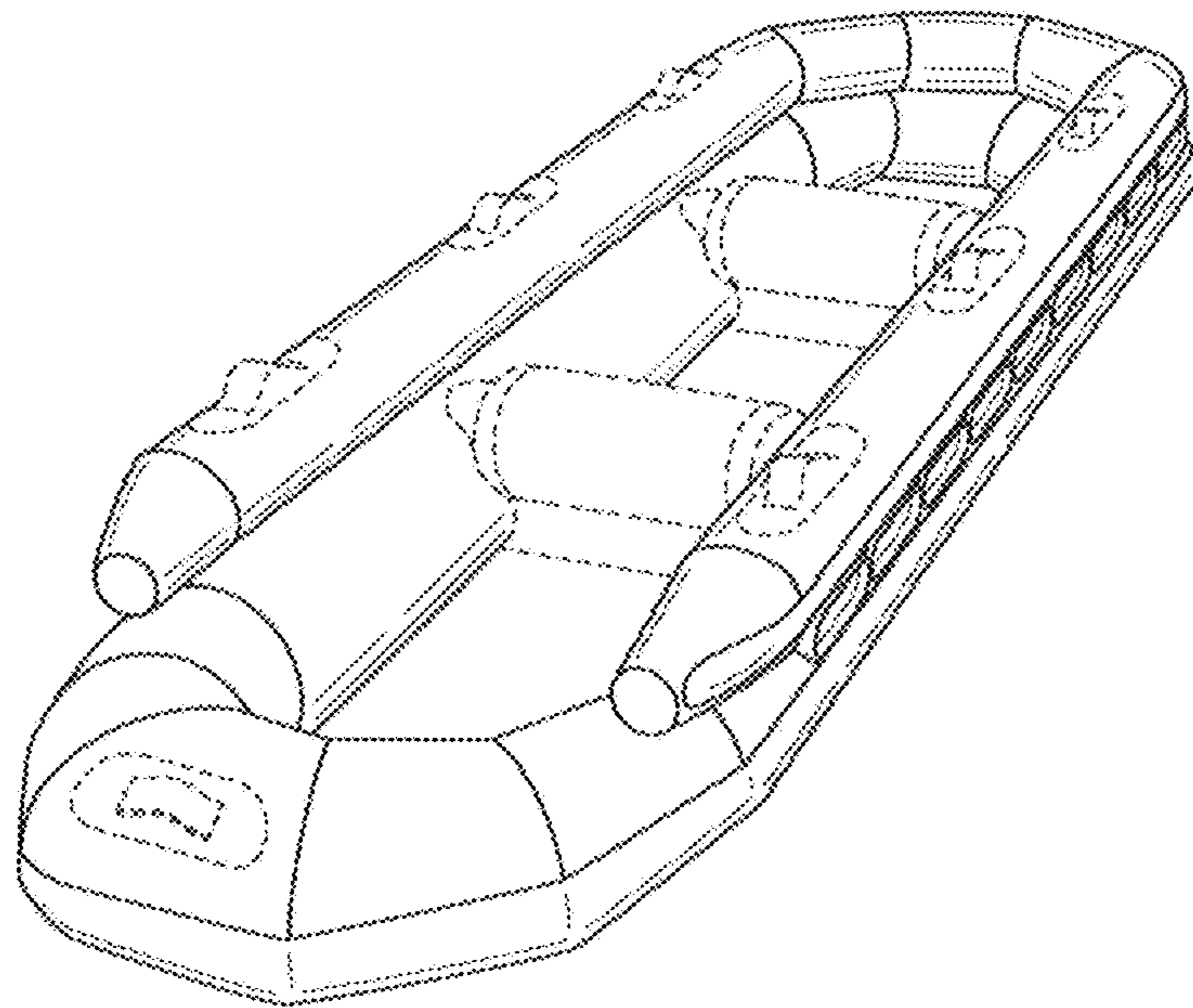

FIG. 22

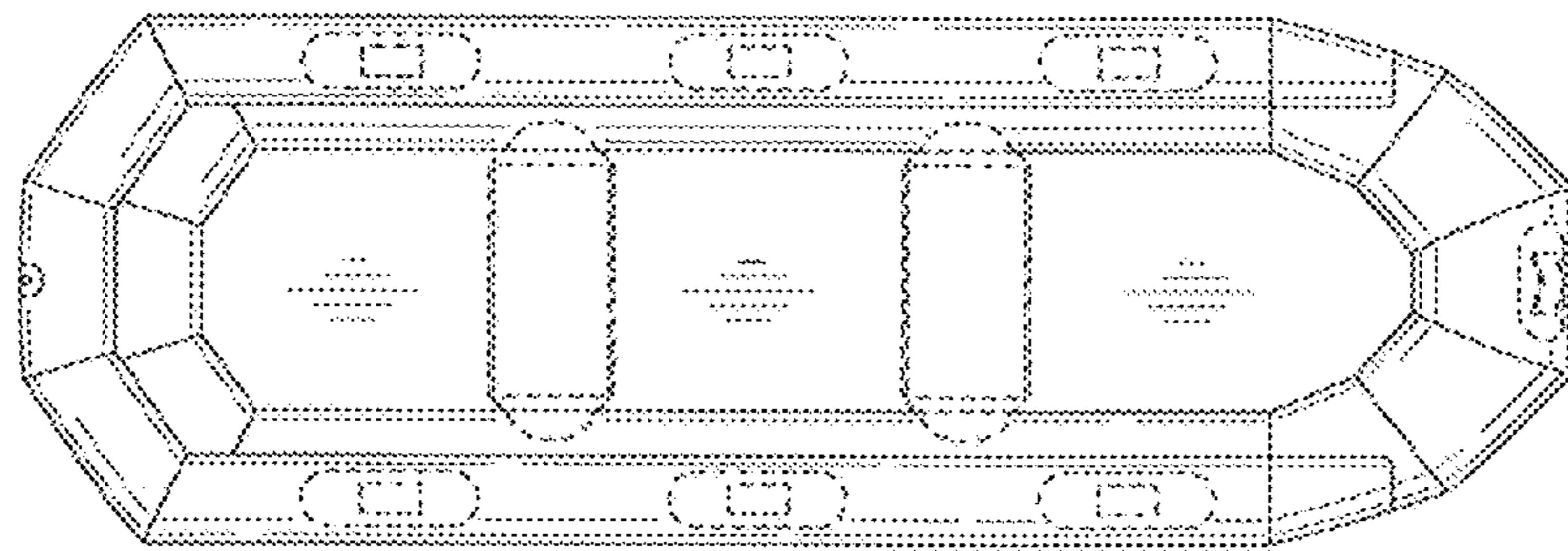

FIG. 23

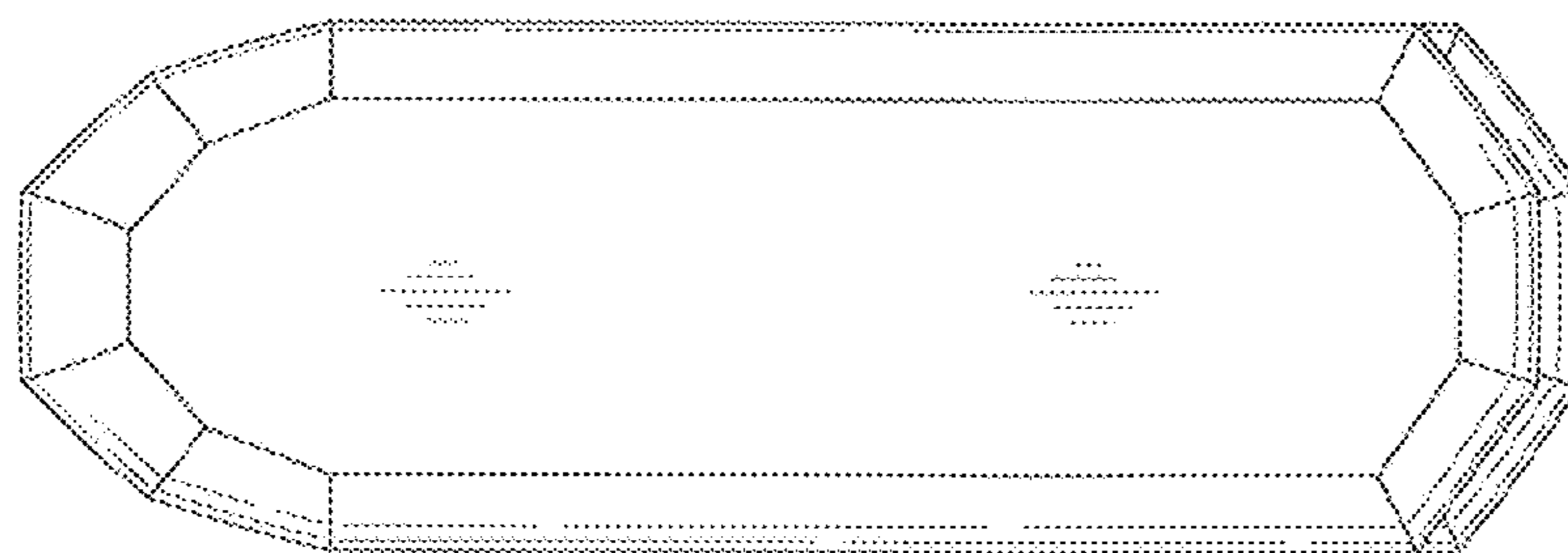

FIG. 24

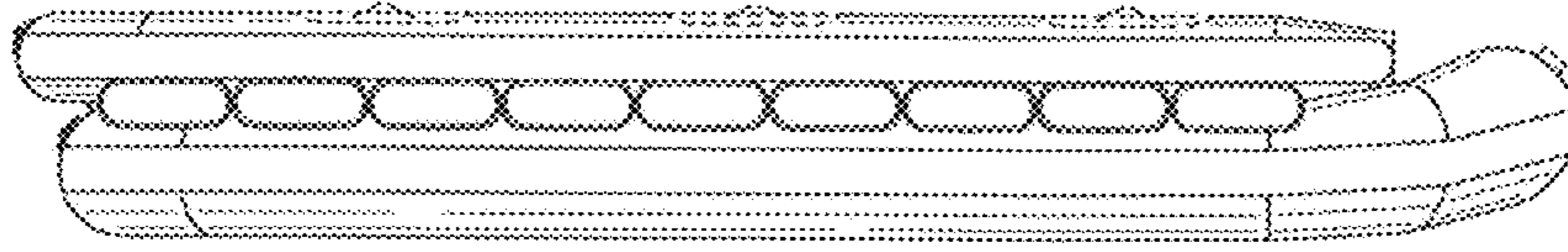

FIG. 25

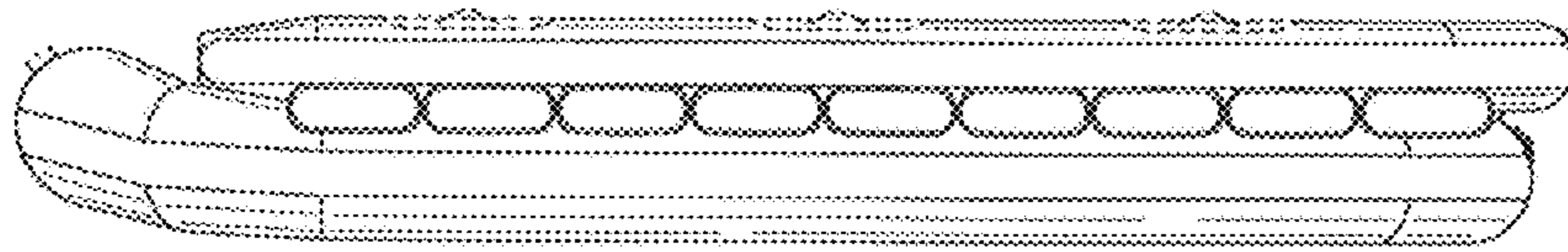

FIG. 26

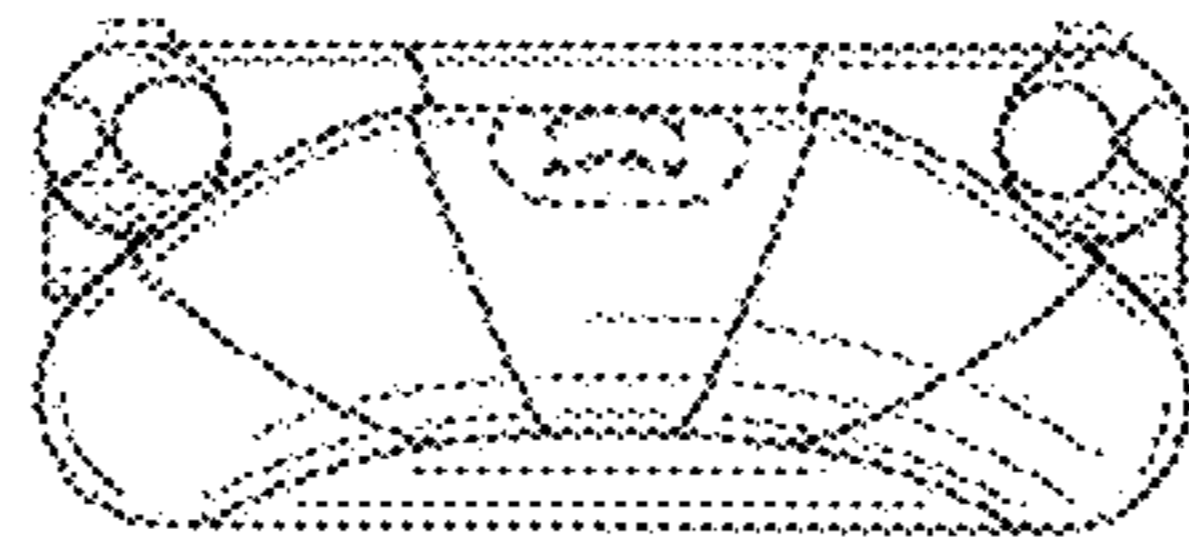

FIG. 27

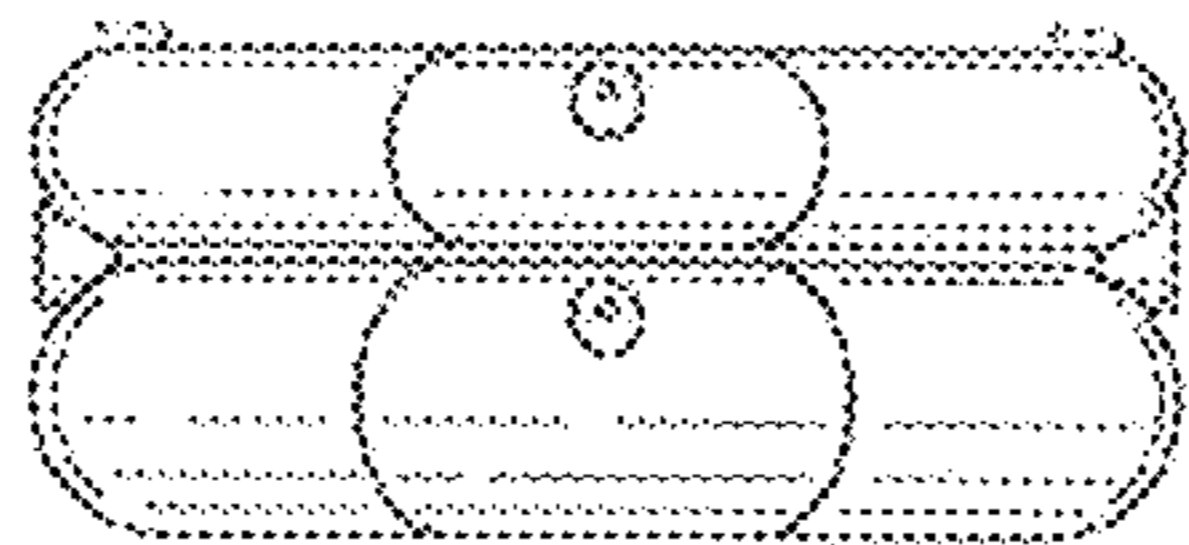

FIG. 28