



US00D846453S

(12) **United States Design Patent**
Koby et al.

(10) **Patent No.:** **US D846,453 S**

(45) **Date of Patent:** **** Apr. 23, 2019**

(54) **WHEEL FOR A MOBILITY ASSISTANCE APPARATUS**

(71) Applicant: **Koby Keyes Product Design, LLC**,
Carlsbad, CA (US)

(72) Inventors: **Jack Koby**, Carlsbad, CA (US); **Carly Keyes**, Encinitas, CA (US)

(73) Assignee: **Koby Keyes Product Design, LLC**,
Carlsbad, CA (US)

(**) Term: **15 Years**

(21) Appl. No.: **29/617,908**

(22) Filed: **Sep. 16, 2017**

(51) **LOC (11) Cl.** **12-12**

(52) **U.S. Cl.**
USPC **D12/133**

(58) **Field of Classification Search**
USPC D12/204–213, 128–133
CPC B60B 7/00; B60B 7/02; B60B 7/04; B60B 7/01;
B60B 7/06; B60B 3/02; B60B 3/04; B60B 3/06;
B60B 3/10; B60B 1/00; B60B 1/08; B60B 1/10; B60B 1/12
See application file for complete search history.

(56) **References Cited**

U.S. PATENT DOCUMENTS

D339,320	S	*	9/1993	Harr	D12/209
D421,941	S	*	3/2000	Cheng	D12/209
8,176,957	B2		5/2012	Manesh et al.		
8,944,125	B2		2/2015	Manesh et al.		
D739,794	S	*	9/2015	Juskowich	D12/133

D739,795	S	*	9/2015	Juskowich	D12/133
D785,511	S	*	5/2017	Barenbrug	D12/133
D823,734	S	*	7/2018	Myrene	D12/133
D826,129	S	*	8/2018	Fukuta	D12/209

* cited by examiner

Primary Examiner — Stacia A Cadmus

(74) *Attorney, Agent, or Firm* — Clause Eight IPS;
Michael Catania

(57) **CLAIM**

The ornamental design for a wheel for a mobility assistance apparatus, as shown and described.

DESCRIPTION

FIG. 1 is a front elevation view of a first embodiment of a wheel for a mobility assistance apparatus, showing our new design;

FIG. 2 is a rear elevation view thereof;

FIG. 3 is a side elevation view thereof;

FIG. 4 is a side elevation view thereof;

FIG. 5 is a top plan view thereof;

FIG. 6 is a bottom plan view thereof;

FIG. 7 is a top plan perspective view thereof;

FIG. 8 is a front elevation view of a second embodiment of a wheel for a mobility assistance apparatus, showing our new design;

FIG. 9 is a rear elevation view thereof;

FIG. 10 is a side elevation view thereof;

FIG. 11 is a side elevation view thereof;

FIG. 12 is a top plan view thereof;

FIG. 13 is a bottom plan view thereof; and,

FIG. 14 is a top plan perspective view thereof.

1 Claim, 8 Drawing Sheets

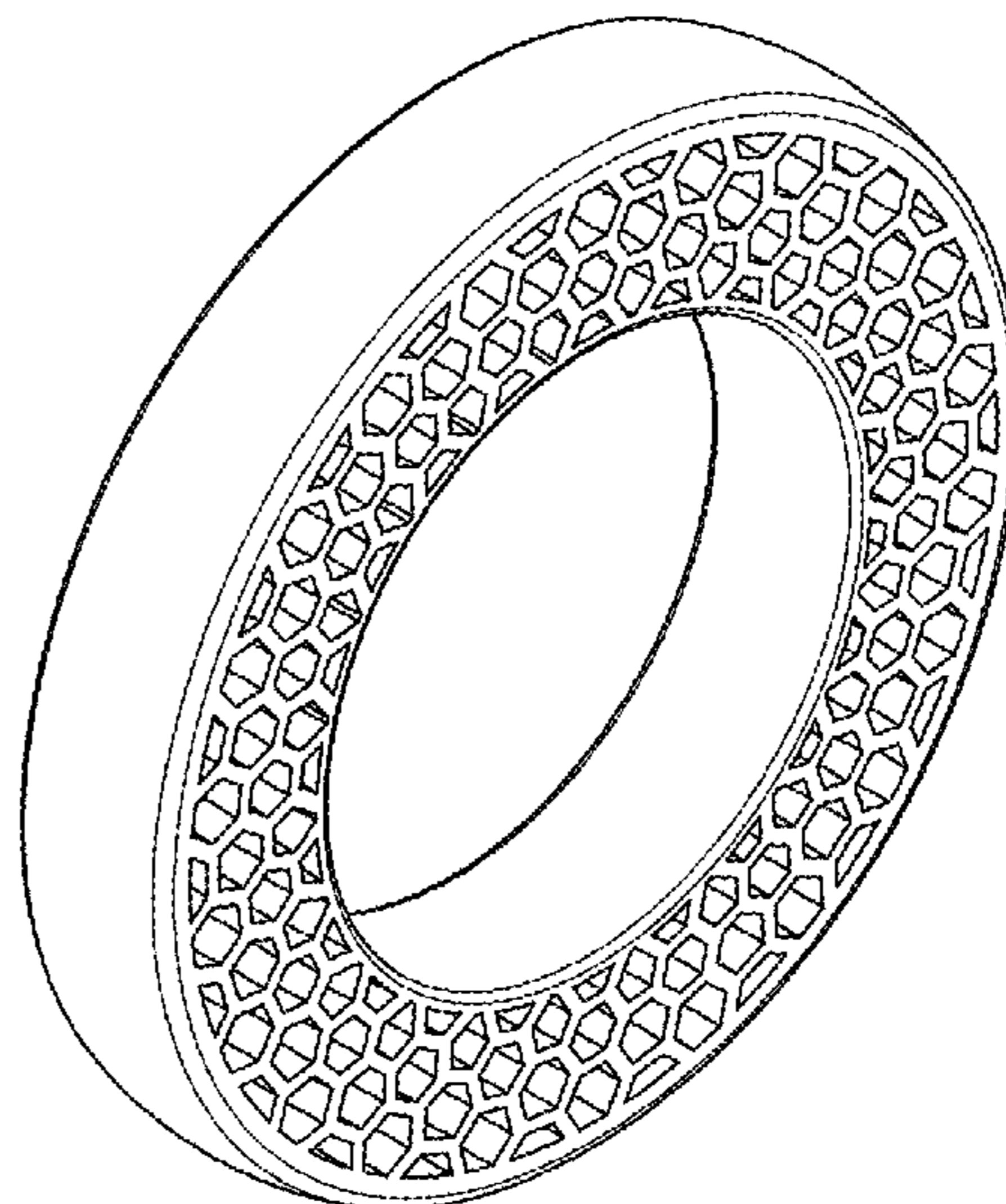
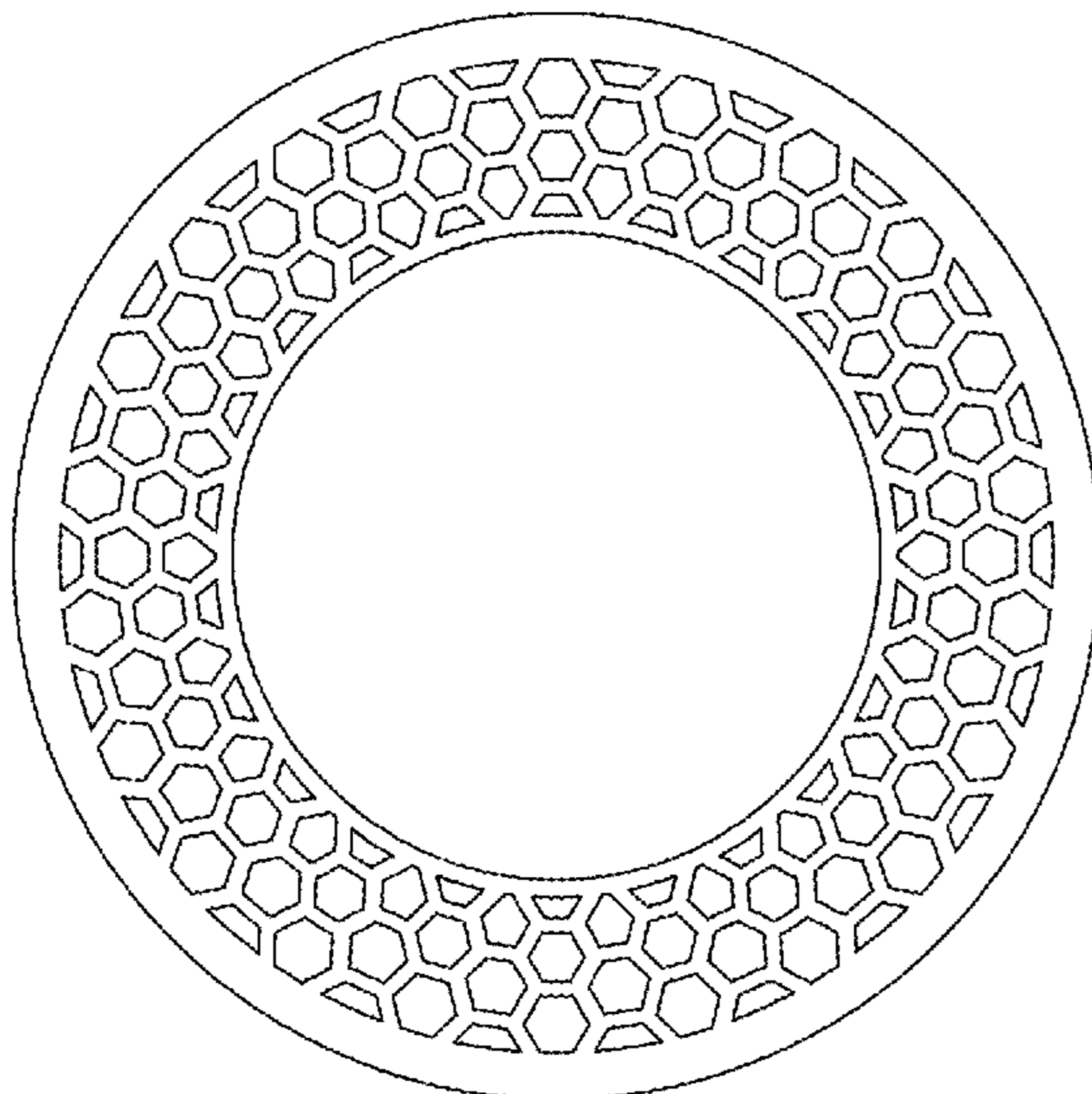

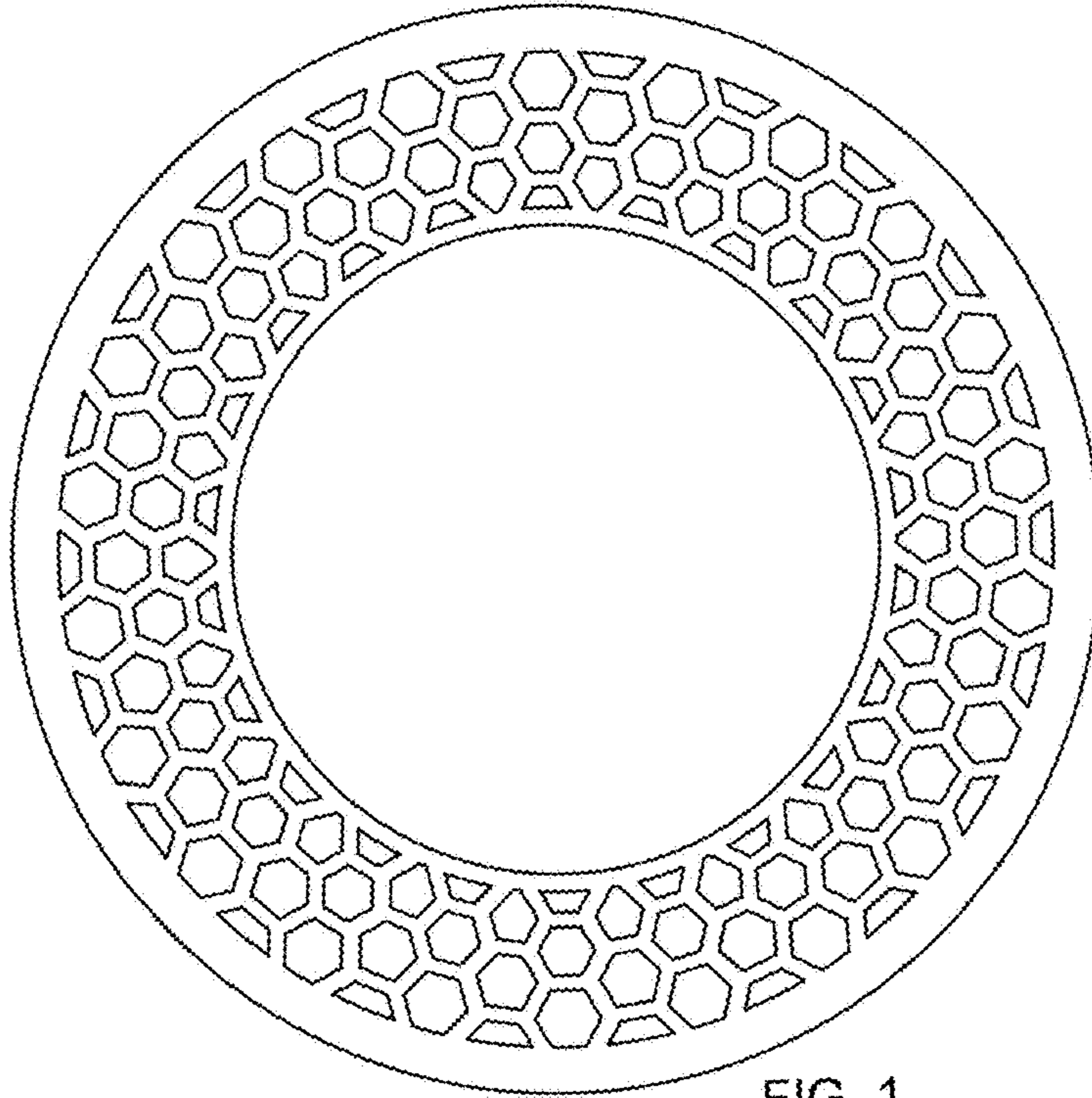

FIG. 1

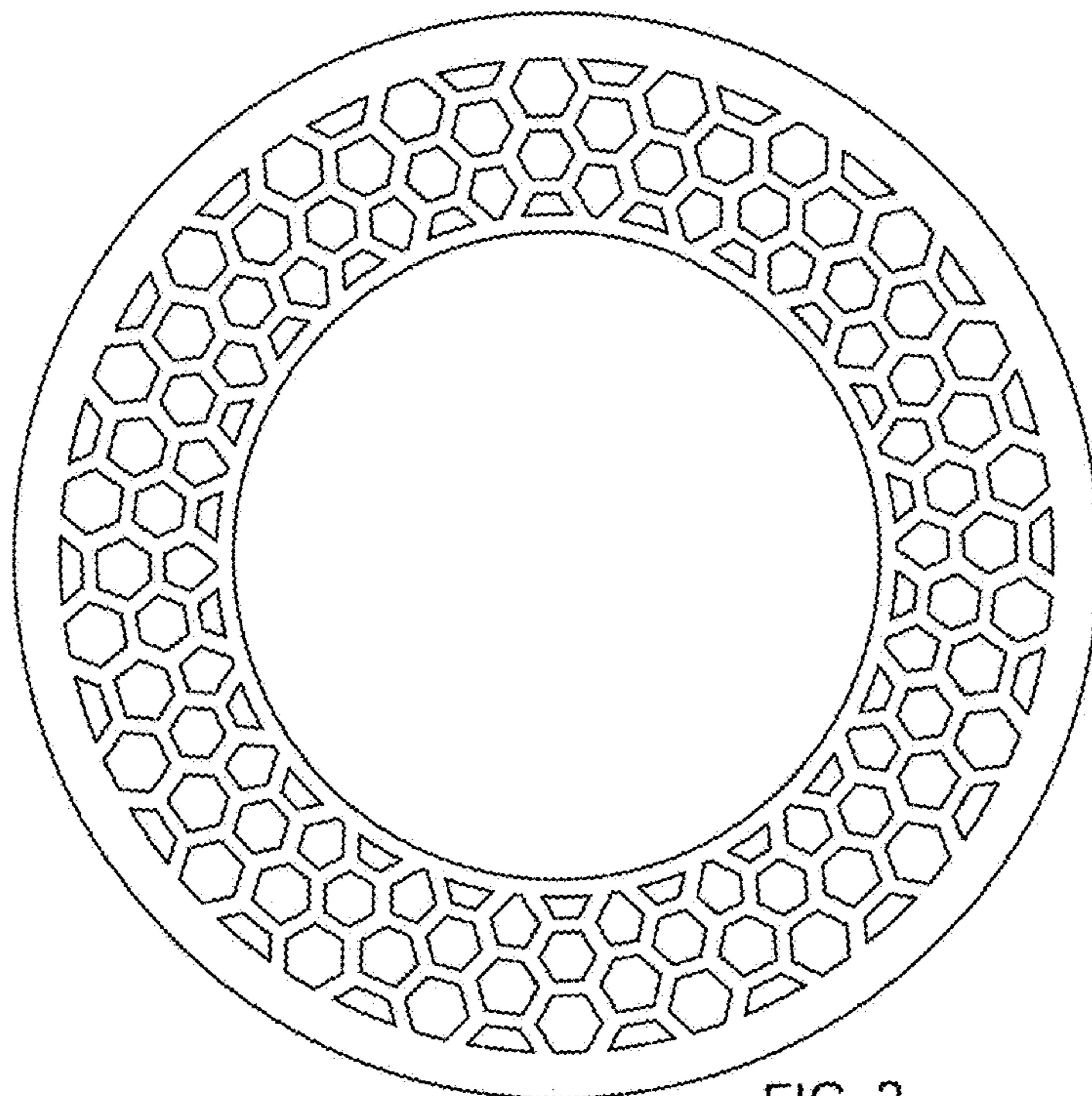

FIG. 2

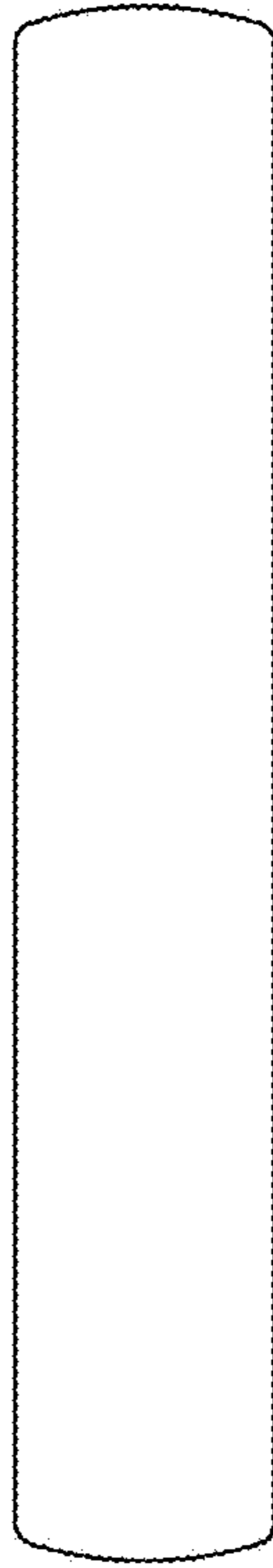

FIG. 3

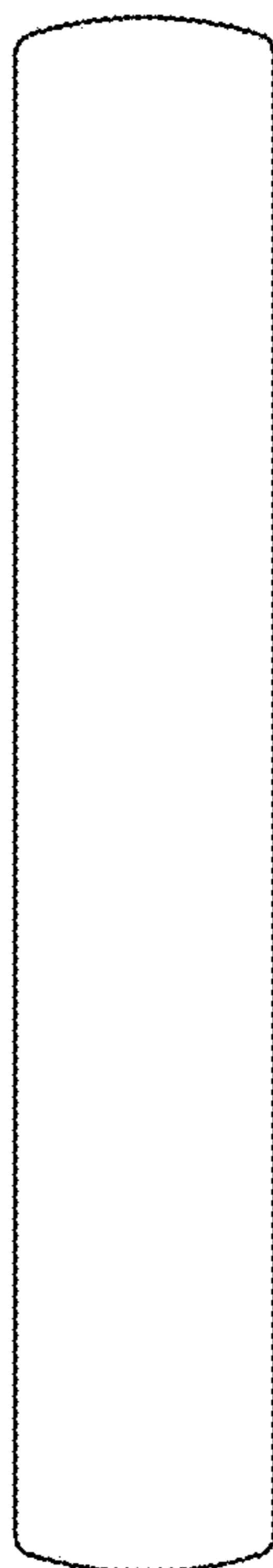

FIG. 4



FIG. 5



FIG. 6

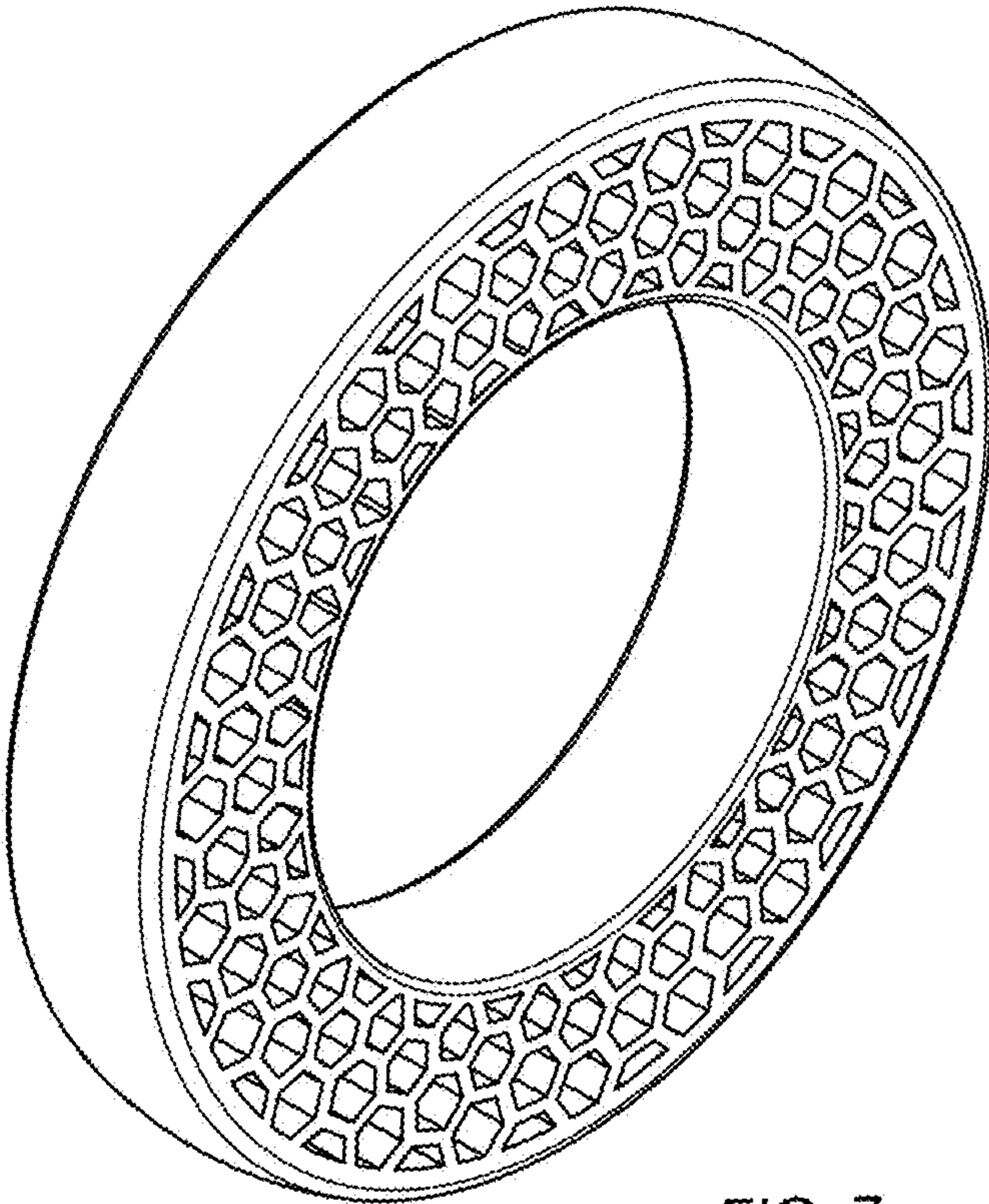

FIG. 7

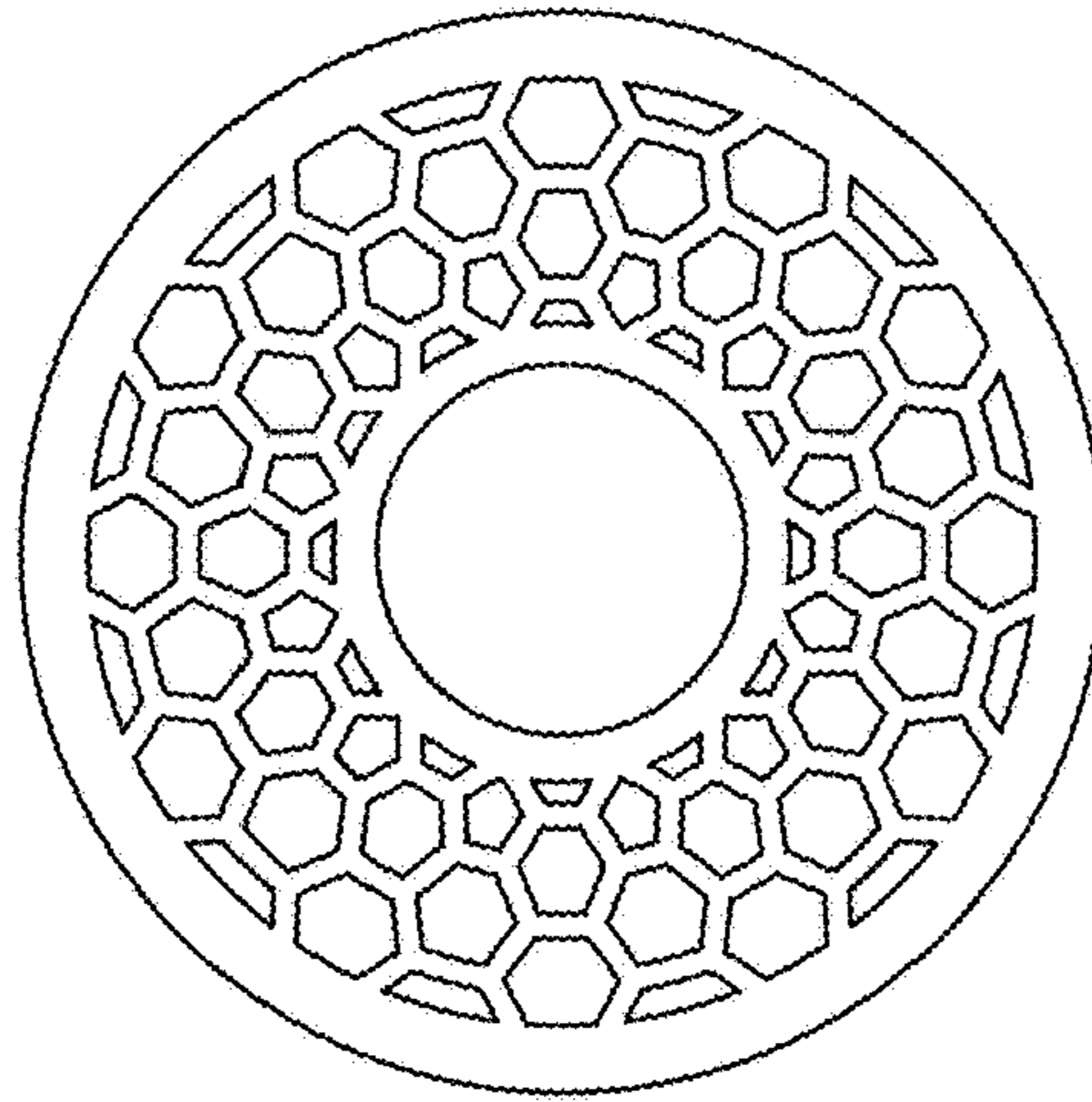

FIG. 8

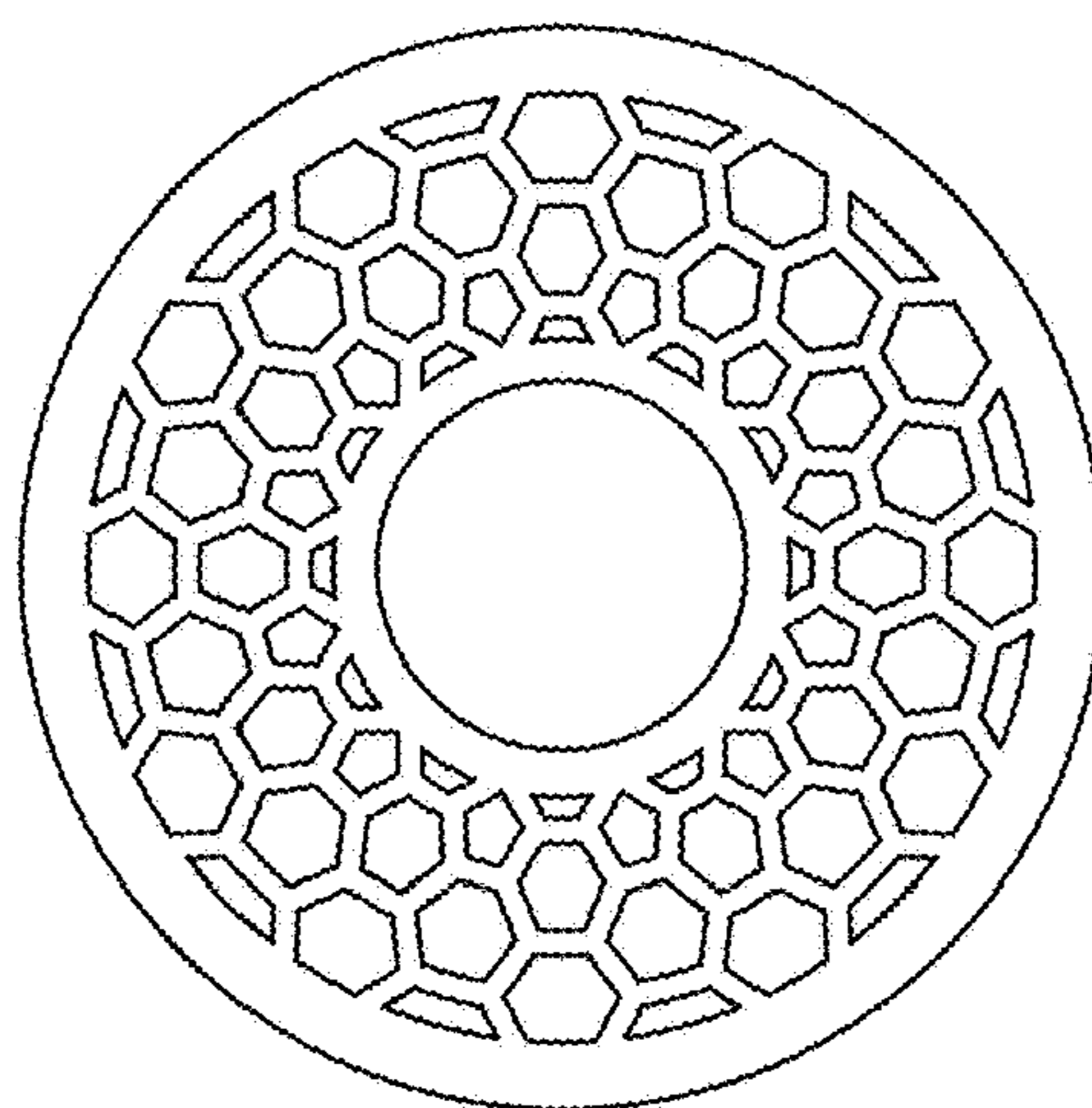

FIG. 9

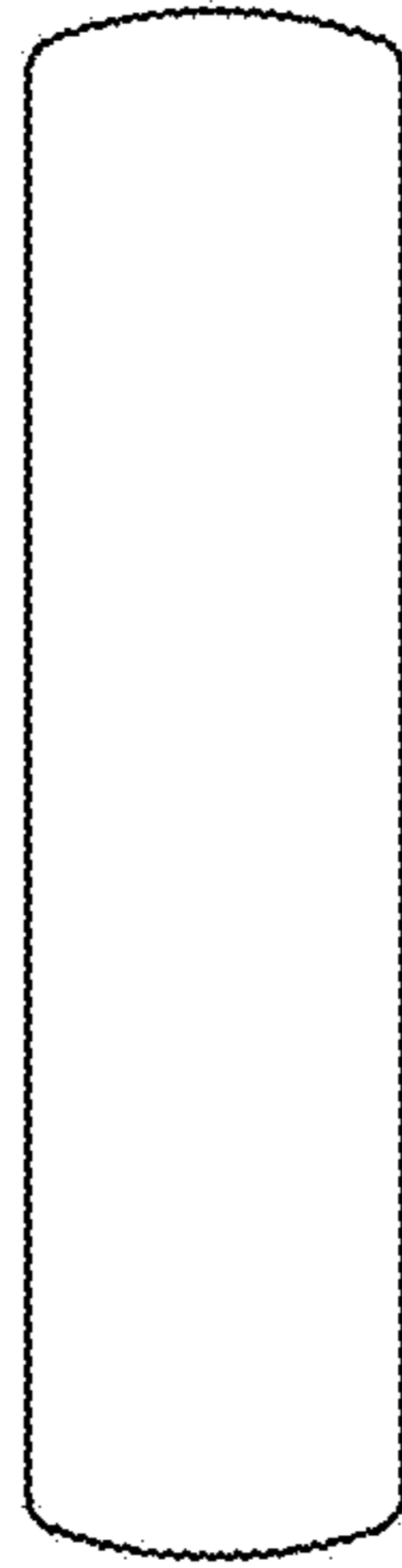

FIG. 10

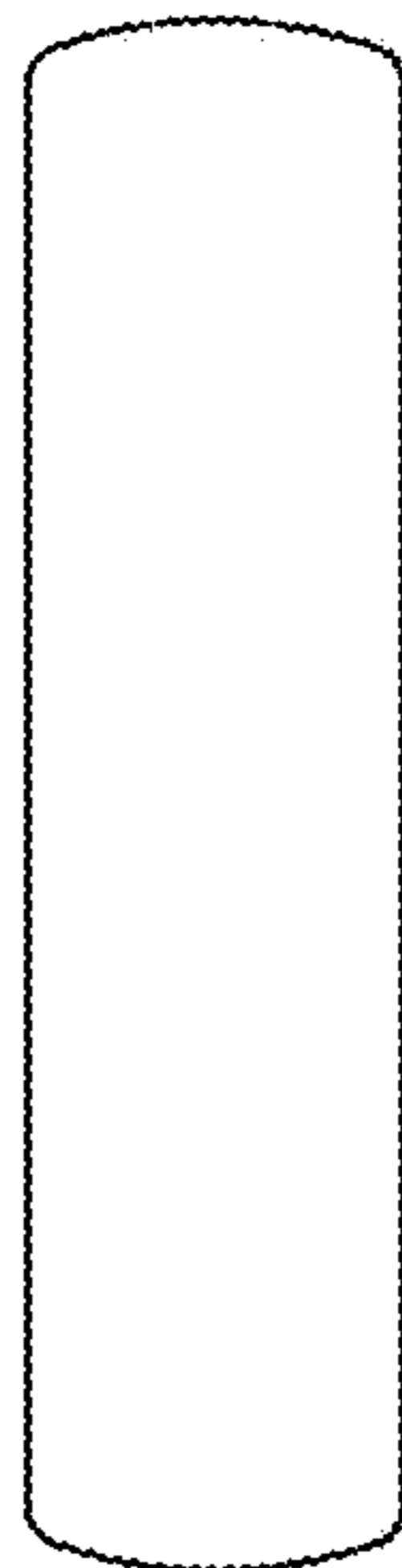

FIG. 11

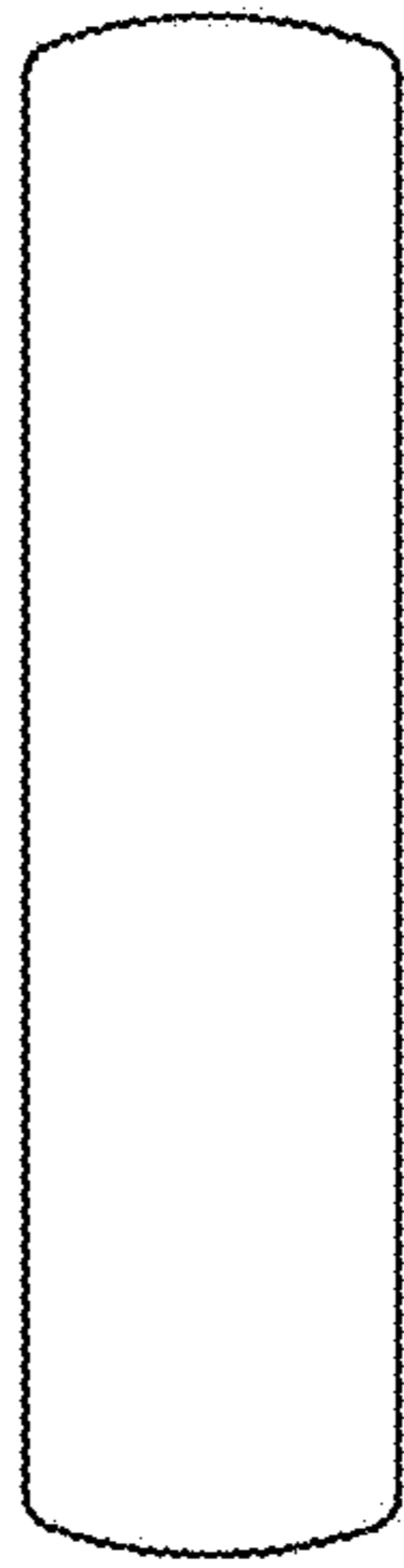

FIG. 12

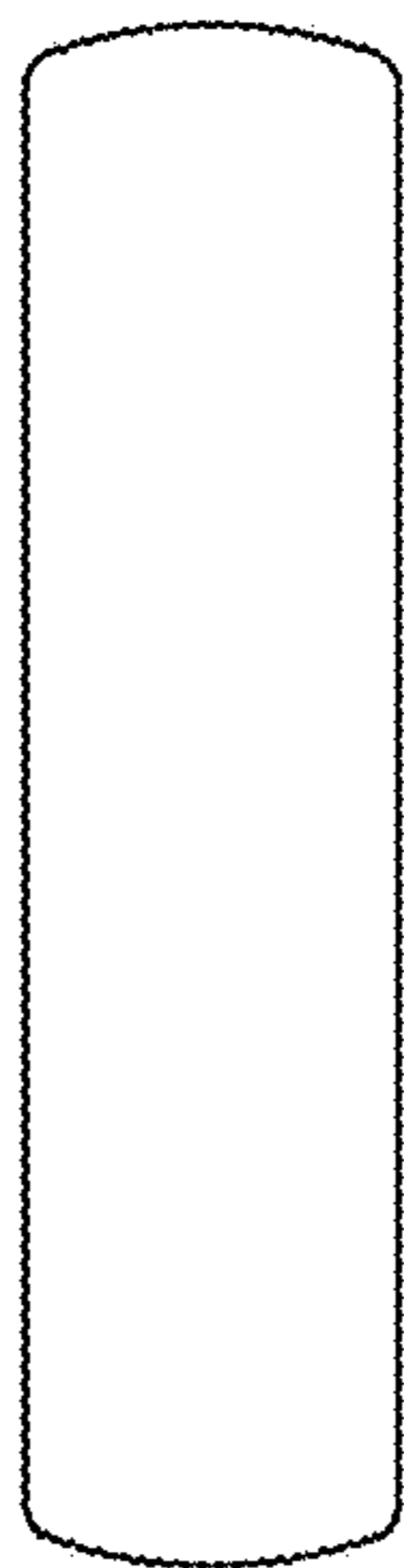

FIG. 13

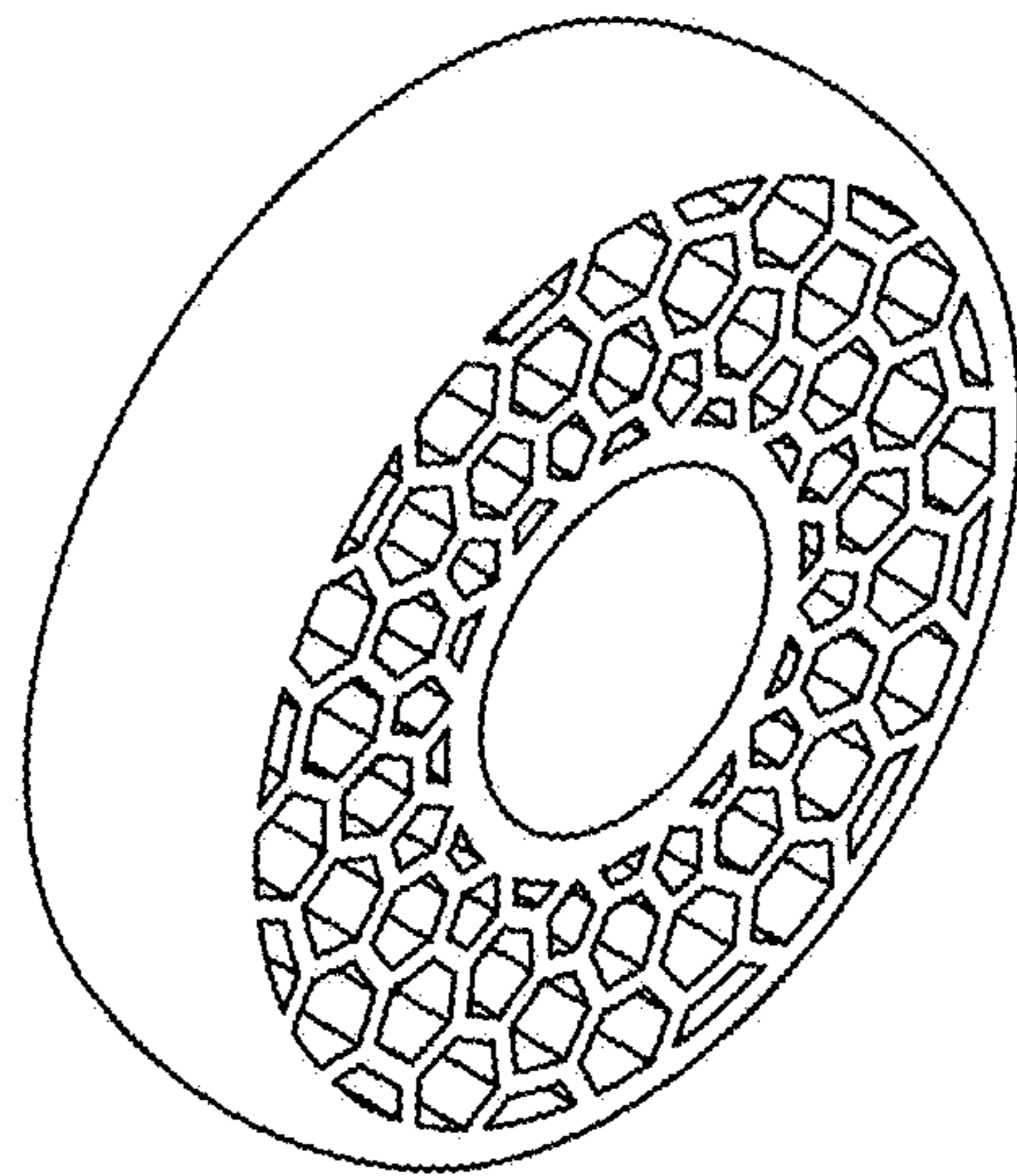

FIG. 14