



US00D846385S

(12) **United States Design Patent** (10) **Patent No.:** **US D846,385 S**
Borkovetz et al. (45) **Date of Patent:** **** *Apr. 23, 2019**

(54) **PACKAGE**

(71) Applicants: **Kimberly-Clark Worldwide, Inc.**,
Neenah, WI (US); **Graphic Packaging**
International, Inc., Atlanta, GA (US)

(72) Inventors: **Thomas F. Borkovetz**, Hortonville, WI
(US); **Keith R. Haen**, Neenah, WI
(US); **Dana Marie Exner**, Park Ridge,
IL (US); **Ronald Edward Hajek**, Joliet,
IL (US)

(73) Assignee: **Kimberly-Clark Worldwide, Inc.**,
Neenah, WI (US)

(*) Notice: This patent is subject to a terminal dis-
claimer.

(**) Term: **15 Years**

(21) Appl. No.: **29/634,937**

(22) Filed: **Jan. 25, 2018**

Related U.S. Application Data

(62) Division of application No. 29/589,142, filed on Dec.
28, 2016, now Pat. No. Des. 813,029.

(51) **LOC (11) Cl.** **09-07**

(52) **U.S. Cl.**
USPC **D9/434; D9/432**

(58) **Field of Classification Search**
USPC D9/414-423, 430-432, 433, 434, 456,
D9/457, 711, 713, 721-722
CPC ... B65D 5/00; B65D 5/02; B65D 5/18; B65D
5/20
See application file for complete search history.

(56) **References Cited**

U.S. PATENT DOCUMENTS

2,967,610 A 1/1961 Ebert et al.
3,090,483 A 5/1963 Atree et al.
3,158,312 A 11/1964 Daniel

3,215,332 A 11/1965 Bess
3,860,304 A 1/1975 Bolton
4,252,236 A 2/1981 Roccaforte
4,778,057 A 10/1988 Allen et al.
4,793,487 A 12/1988 Bentsen et al.
4,883,675 A 11/1989 Wernz

(Continued)

FOREIGN PATENT DOCUMENTS

WO WO 2006/061839 A2 6/2006
WO WO 2007/070998 A2 6/2007

OTHER PUBLICATIONS

Co-pending U.S. Appl. No. 29/634,930, filed Jan. 25, 2018, by Haen
et al. for "Package."

(Continued)

Primary Examiner — Vy N Koenig

(74) *Attorney, Agent, or Firm* — Kimberly-Clark
Worldwide, Inc.

(57) **CLAIM**

The ornamental design for a package, as shown and
described.

DESCRIPTION

FIG. 1 is a perspective view of a package showing our new
design;
FIG. 2 is a front view of the package of FIG. 1;
FIG. 3 is a back view of the package of FIG. 1;
FIG. 4 is a first side view of the package of FIG. 1;
FIG. 5 is a second side view of the package of FIG. 1;
FIG. 6 is a top view of the package of FIG. 1; and,
FIG. 7 is a bottom view of the package of FIG. 1.
In the drawings, the evenly spaced broken lines represent
environmental structure and form no part of the claimed
design; the dash-dot-dot-dash broken lines represent bound-
aries of the claimed design and form no part of the claimed
design.

1 Claim, 6 Drawing Sheets

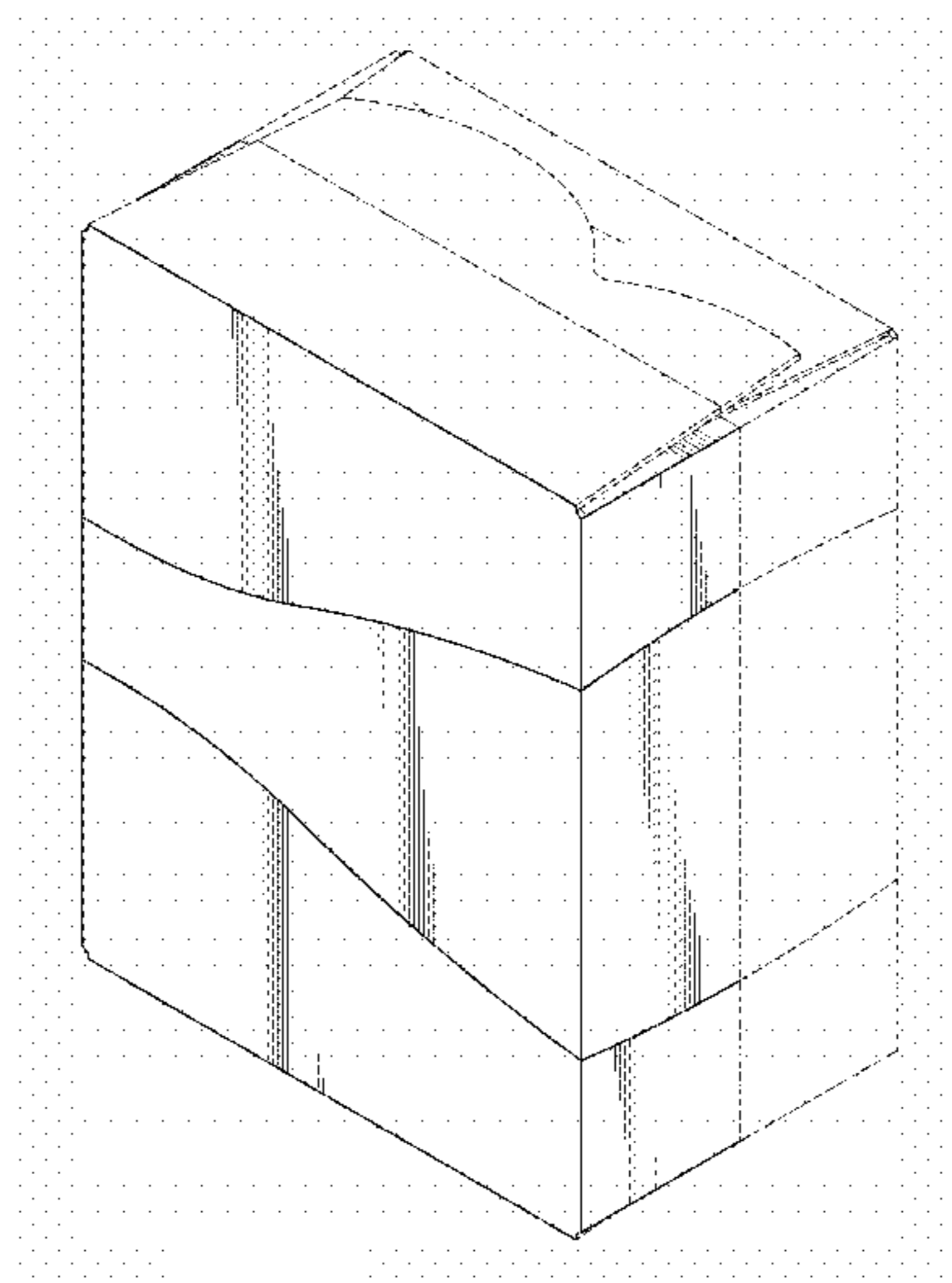

(56)

References Cited

U.S. PATENT DOCUMENTS

4,905,837 A * 3/1990 Schuster B65D 5/5475
229/120.011

4,964,526 A 10/1990 Stephens

5,318,223 A 6/1994 Gale

5,361,905 A 11/1994 McQueeney et al.

5,533,667 A 7/1996 Gale

D495,253 S * 8/2004 Hamuro D9/432

D496,275 S 9/2004 Hamuro et al.

D496,859 S * 10/2004 Hamuro D9/432

6,799,695 B1 10/2004 Borrero

D524,654 S * 7/2006 Harada D9/457

D526,194 S * 8/2006 Hamuro D9/432

D527,253 S 8/2006 Hamuro et al.

D543,110 S * 5/2007 Harada D9/457

7,373,765 B2 5/2008 Welchel et al.

D586,210 S 2/2009 Noschang et al.

D587,111 S 2/2009 Seol et al.

D590,250 S 4/2009 Seol

D590,251 S 4/2009 Seol et al.

D590,252 S 4/2009 Seol et al.

7,913,845 B2 3/2011 Velazquez et al.

D636,667 S 4/2011 Barclay et al.

7,958,994 B2 6/2011 Weinmann

D649,874 S 12/2011 Barclay et al.

D655,156 S 3/2012 Schrimpf et al.

D677,580 S * 3/2013 Powers D9/434

D689,769 S 9/2013 Oates et al.

D692,771 S 11/2013 Sakai et al.

D693,680 S 11/2013 Klopp et al.

D701,760 S 4/2014 Fraser et al.

D703,041 S 4/2014 Abel et al.

D703,533 S 4/2014 Merchant et al.

D705,056 S 5/2014 Gagliardo et al.

D706,629 S 6/2014 Bartels et al.

D706,630 S 6/2014 Merchant et al.

D732,952 S 6/2015 Ghini et al.

D752,439 S 3/2016 Abel et al.

D764,913 S 8/2016 Hood et al.

D768,481 S 10/2016 Gagliardo et al.

D774,400 S * 12/2016 Miyazaki D9/434

D775,964 S * 1/2017 Mochizuki D9/432

D778,167 S * 2/2017 Mochizuki D9/432

D785,452 S 5/2017 Lee et al.

D800,573 S * 10/2017 Mochizuki D9/624

D811,875 S * 3/2018 Haen D9/432

D813,029 S * 3/2018 Borkovetz D9/432

D829,546 S * 10/2018 Gagliardo D9/434

2003/0130632 A1 7/2003 Costea et al.

2009/0108010 A1 4/2009 Ludden-Biegel

2011/0095021 A1 4/2011 Clough

2015/0060537 A1 3/2015 Hajek et al.

2017/0225822 A1 8/2017 Cooper et al.

OTHER PUBLICATIONS

Co-pending U.S. Appl. No. 29/634,933, filed Jan. 25, 2018, by Haen et al. for "Package."

Co-pending U.S. Appl. No. 29/634,935, filed Jan. 25, 2018, by Borkovetz et al. for "Package."

Co-pending U.S. Appl. No. 29/634,928, filed Jan. 25, 2018, by Haen et al. for "Package."

Co-pending U.S. Appl. No. 29/634,938, filed Jan. 25, 2018, by Borkovetz et al. for "Package."

Image of box of Kimberly Clark Kimtech C3 Cleaning Wipes. [online] Published on Oct. 1, 2016. Retrieved Sep. 25, 2017 from URL: "http://static.rshughes.com/wm/p/wm-230-230-ww/261a54acb7a1dcdcf7b6f0a515efefaafd081b6.jpg?uf=Picture-Of-Kimberly-Clark-44851-Kimtech-C3-White-Cleaning-Wipe".

Kimberly Clark Kimtech C3 Cleaning Wipes, Internet web page "www.rshughes.com/p/Kimberly-Clark-Kimtech-C3-White-Cleaning-Wipe-Bx-200-Sheets-Per-Package-12-In-Overall-Length-6-In-Width-44851/036000_44851/", retrieved Sep. 25, 2017, 2 pages.

* cited by examiner

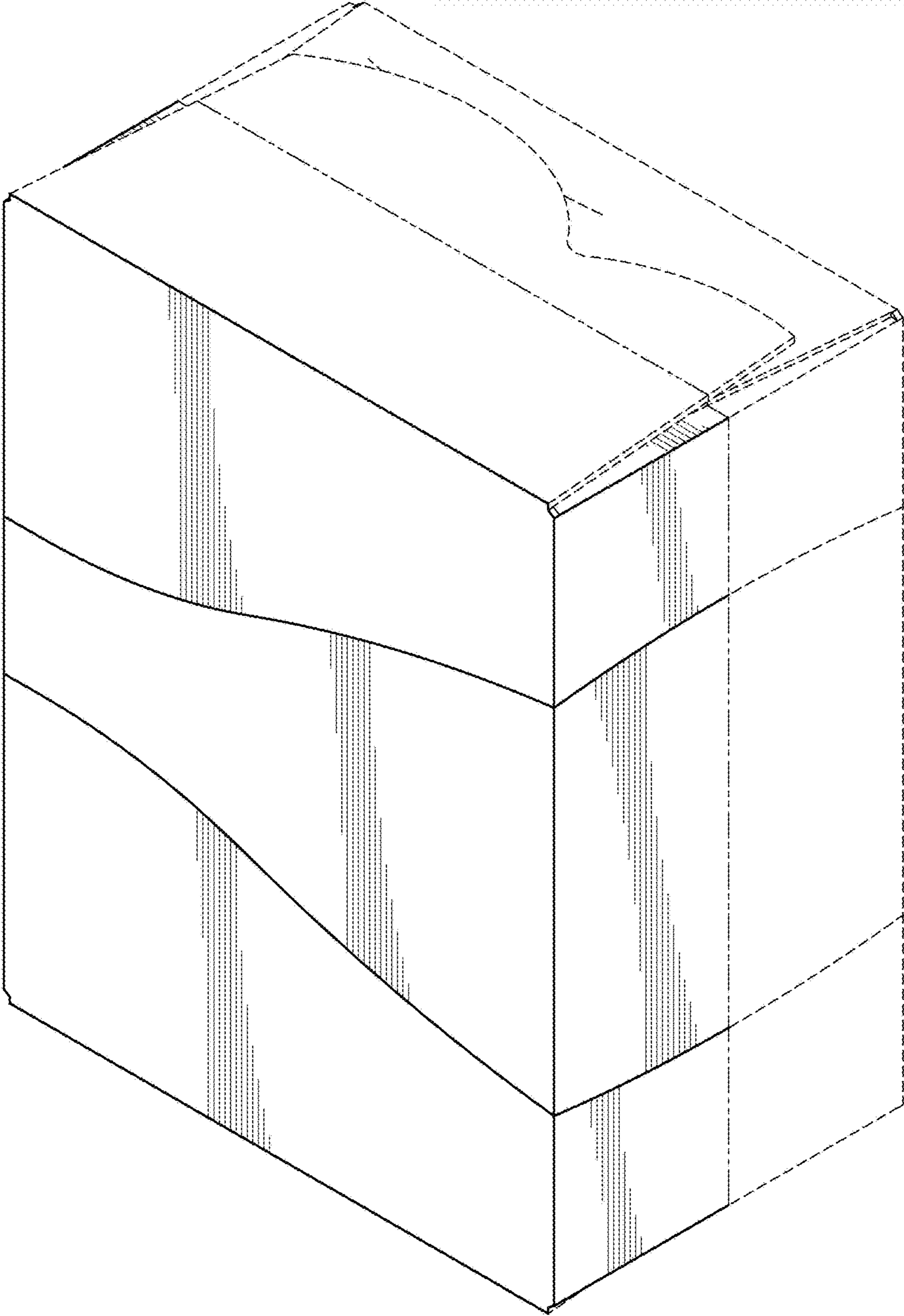

FIG. 1

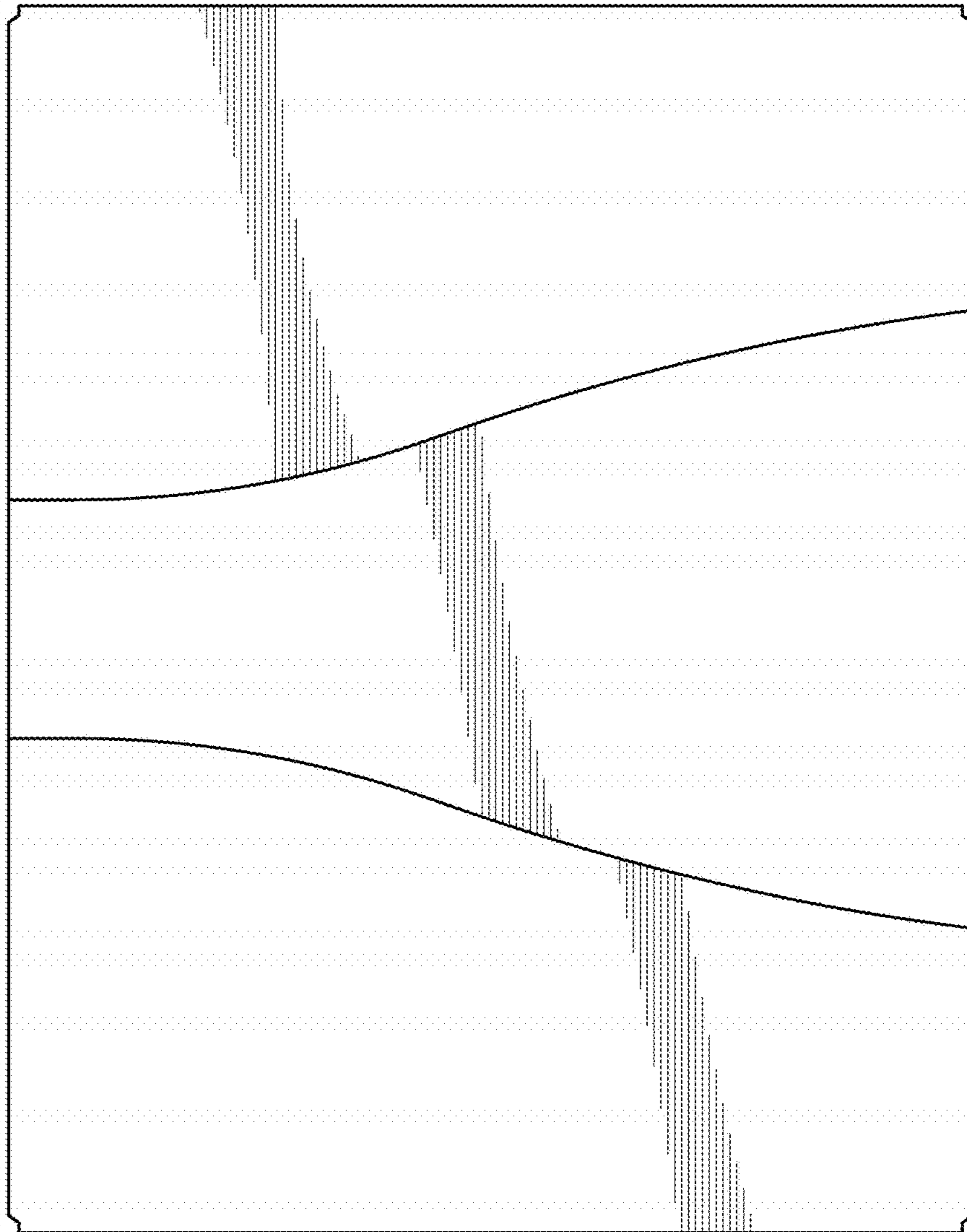

FIG. 2

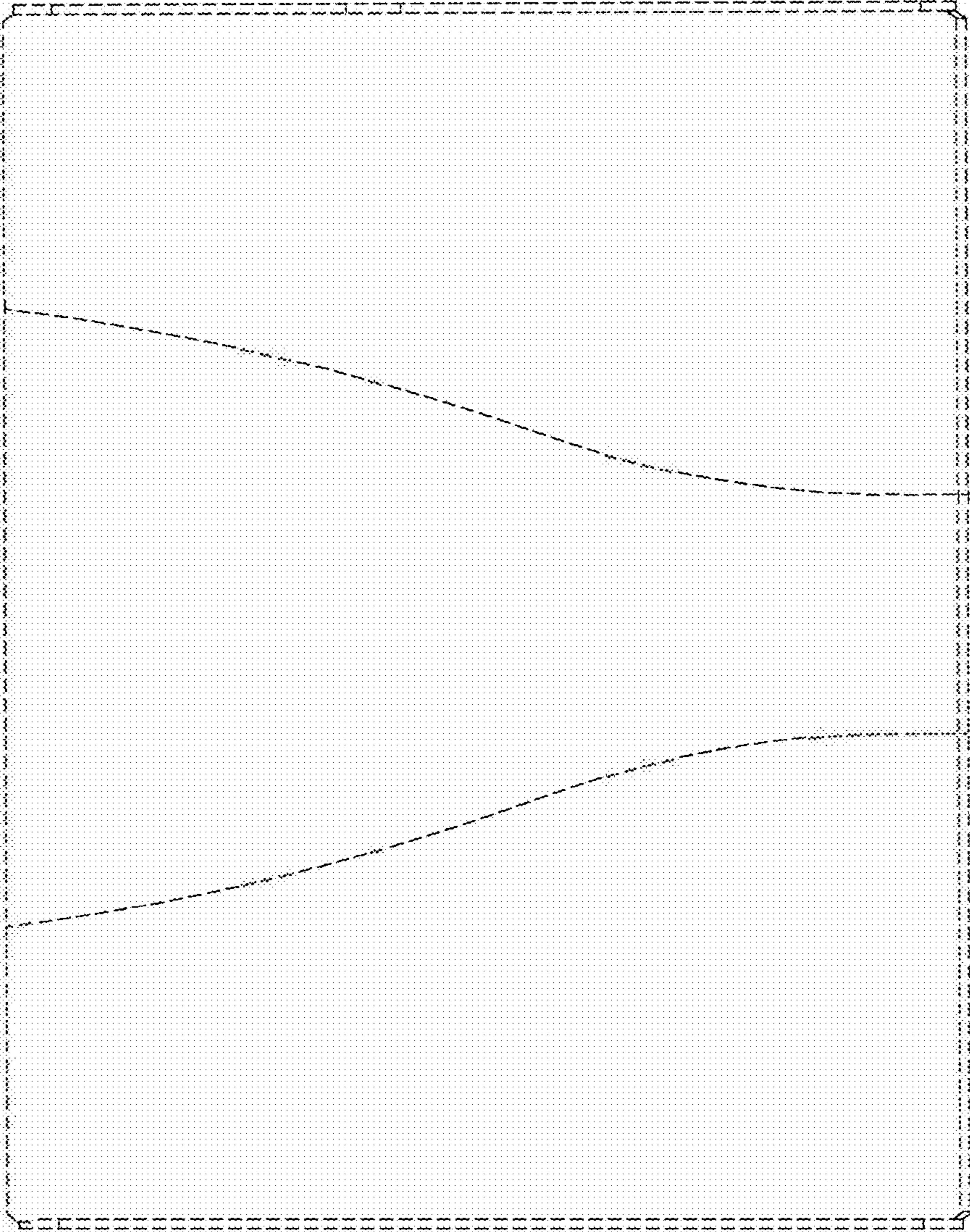

FIG. 3

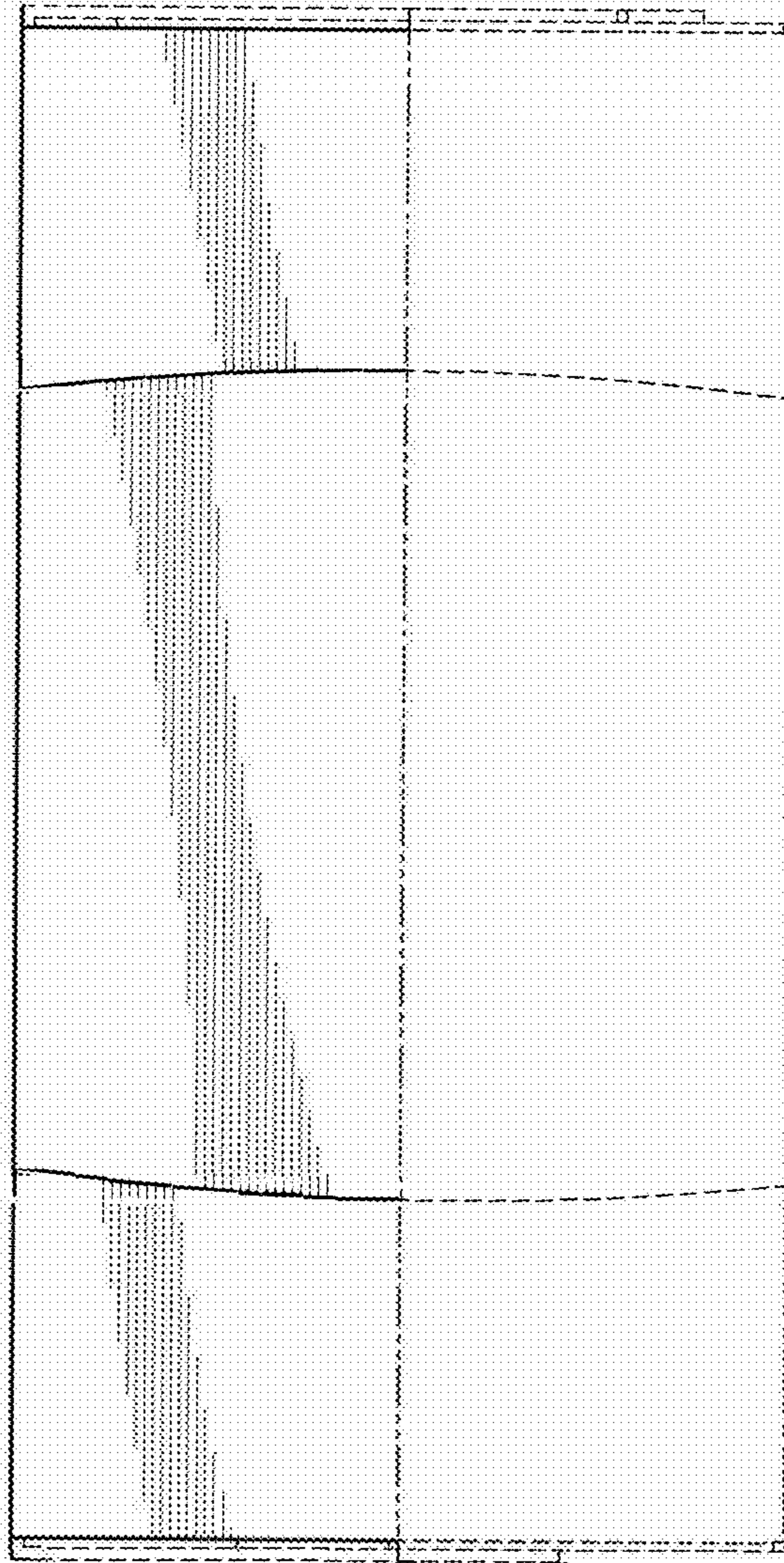

FIG. 4

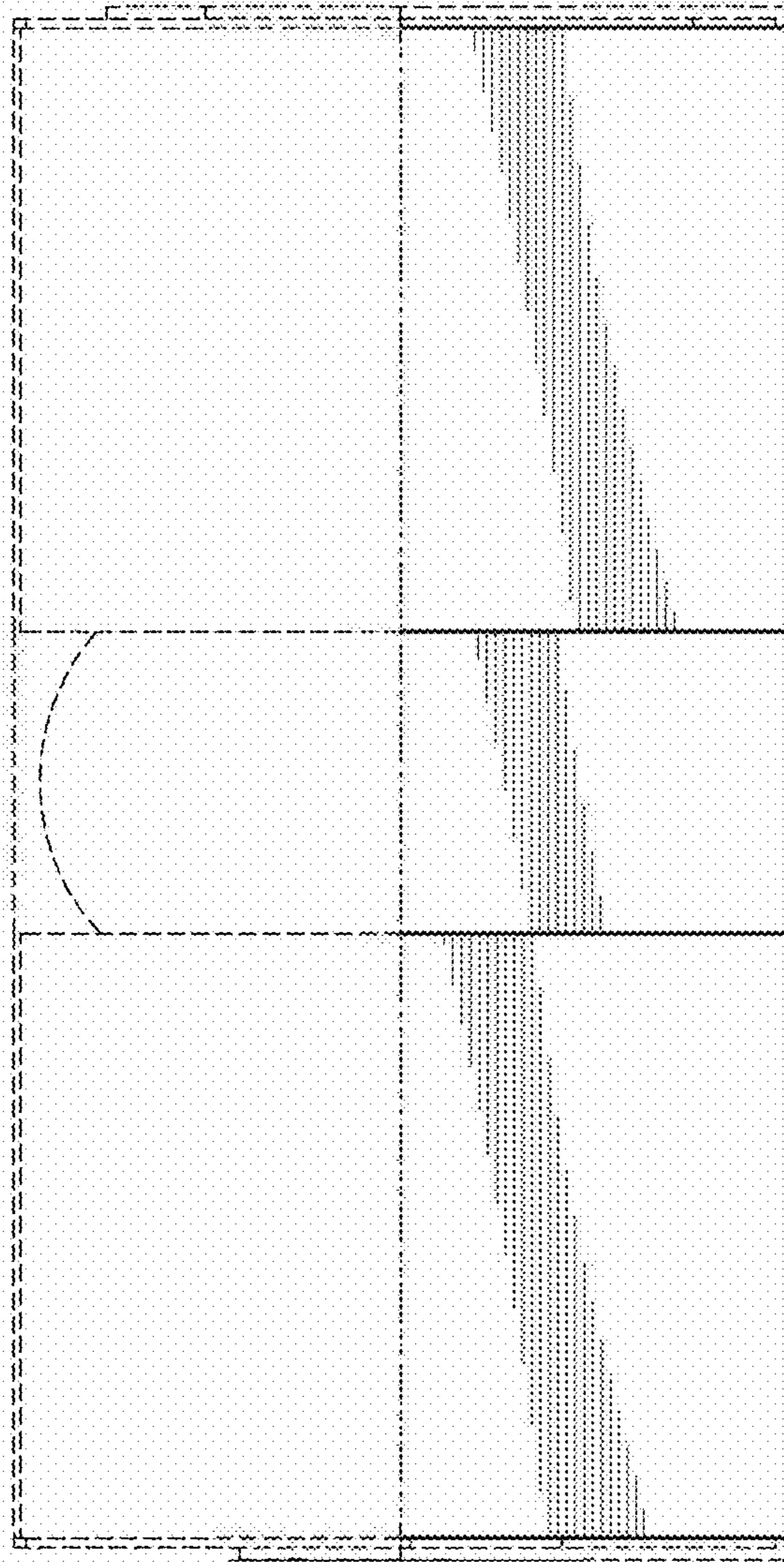

FIG. 5

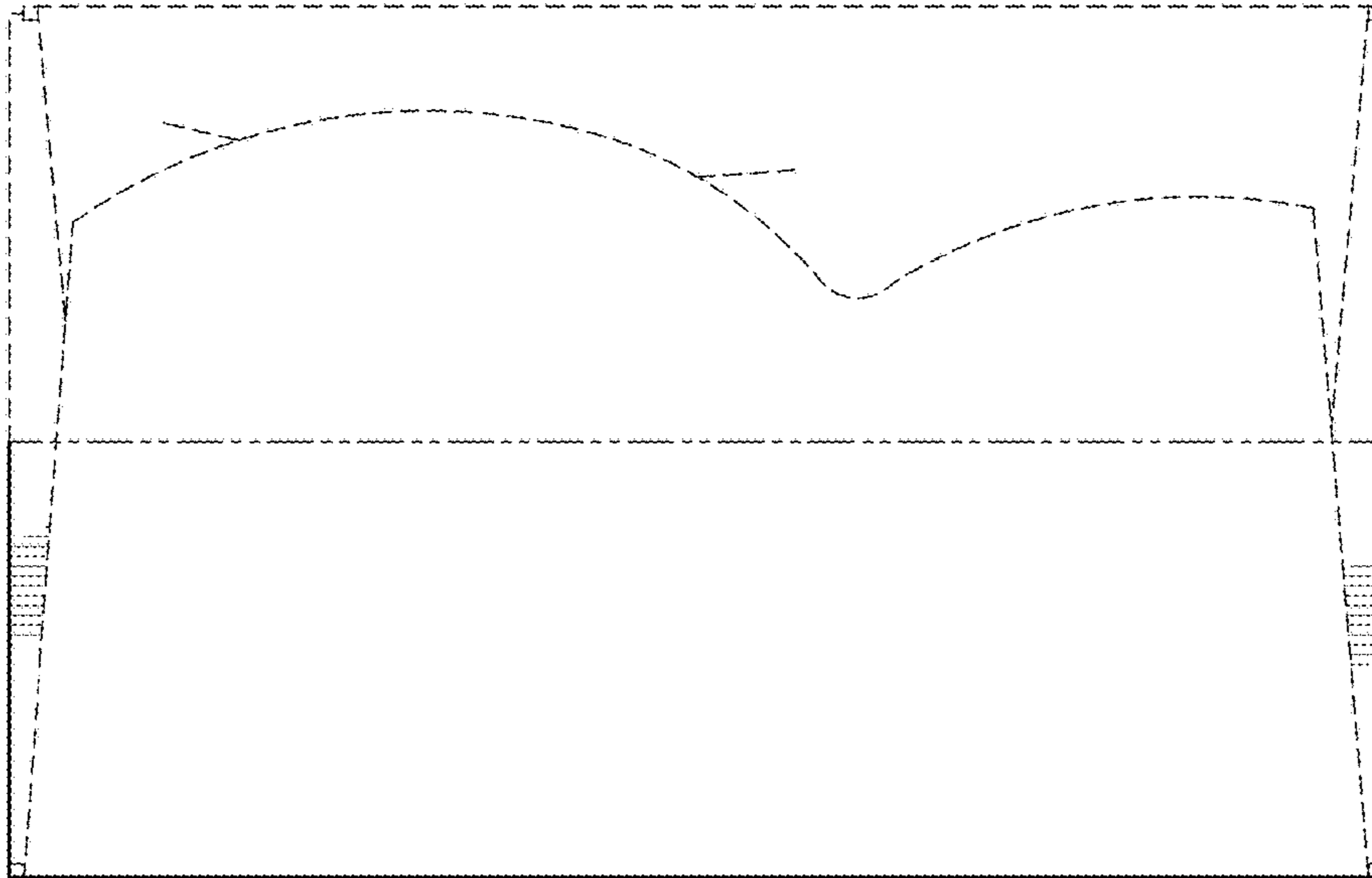

FIG. 6

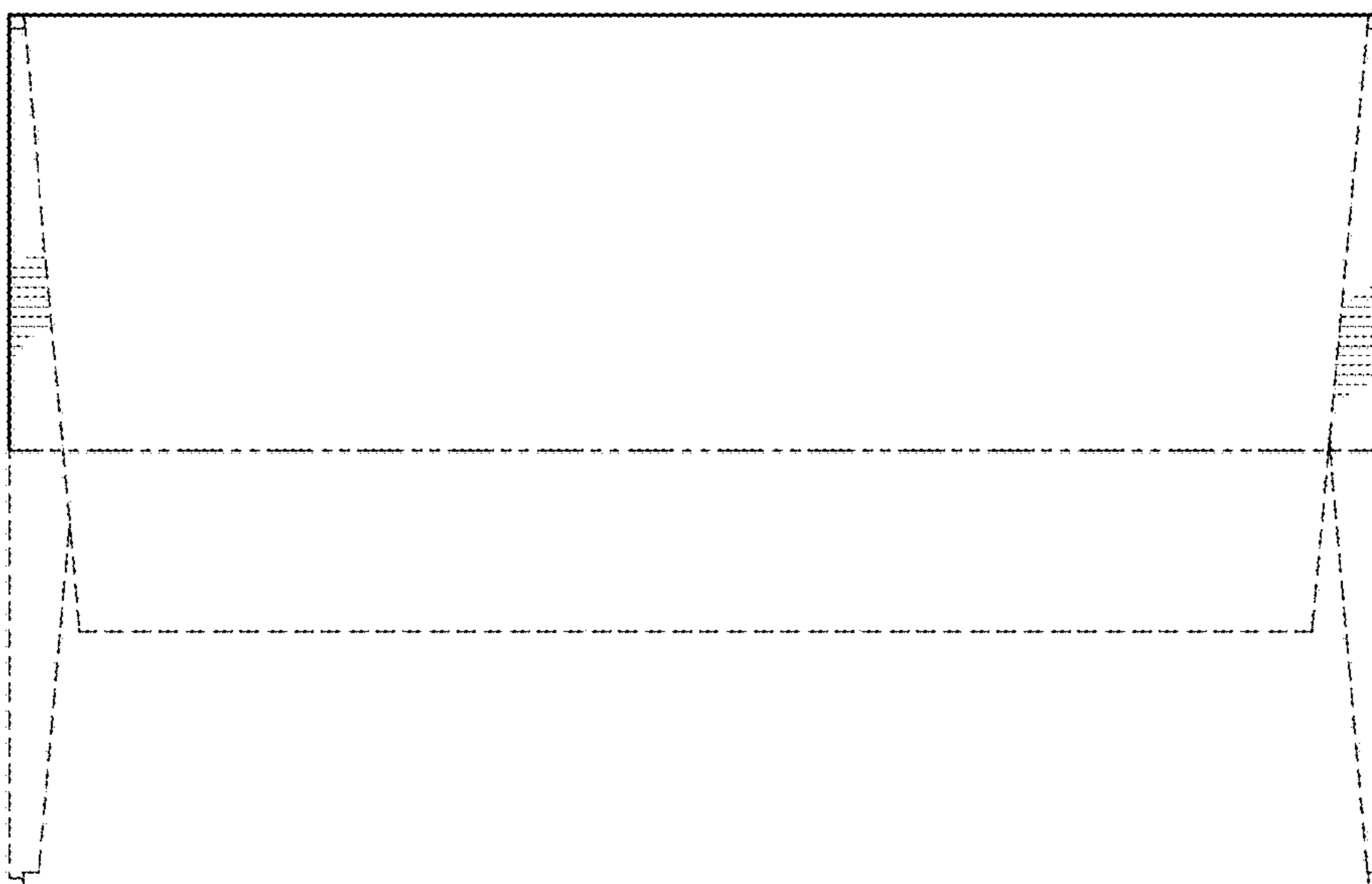

FIG. 7