

US00D846322S

(12) **United States Design Patent** (10) **Patent No.:** **US D846,322 S**
Velez (45) **Date of Patent:** **** Apr. 23, 2019**

- (54) **TABLE**
- (71) Applicant: **Holly Hunt Enterprises, Inc.**, Chicago, IL (US)
- (72) Inventor: **Alberto Velez**, Chicago, IL (US)
- (73) Assignee: **HOLLY HUNT ENTERPRISES, INC.**
- (**) Term: **15 Years**
- (21) Appl. No.: **29/574,066**
- (22) Filed: **Aug. 11, 2016**
- (51) **LOC (11) Cl.** **06-03**
- (52) **U.S. Cl.**
USPC **D6/697**
- (58) **Field of Classification Search**
USPC D6/349, 352, 685, 696, 690, 695,
D6/695.1-695.8, 697, 697.1, 697.2
CPC .. A47B 5/00; A47B 7/00; A47B 13/00; A47B
13/003; A47B 13/02; A47B 13/08; A47B
13/081; A47B 13/088; A47B 13/10; A47B
13/12; A47B 21/00; A47B 87/002; A47B
2200/0001; A47B 2200/0006; A47B
2200/0011
See application file for complete search history.

- D313,708 S * 1/1991 Frank D6/690
- D528,808 S * 9/2006 Gehry D6/349
- D529,303 S * 10/2006 Gehry D6/349
- D705,555 S * 5/2014 Adjaye D6/349
- D734,629 S * 7/2015 Sorel D6/690
- D737,612 S * 9/2015 Nishikawa D6/695

* cited by examiner

Primary Examiner — Mary Ann Calabrese

(74) *Attorney, Agent, or Firm* — The Belles Group, P.C.

(56) **References Cited**

U.S. PATENT DOCUMENTS

- D215,428 S * 9/1969 Tapert 52/DIG. 10
- D228,430 S * 9/1973 Hecker D6/697

(57) **CLAIM**

The ornamental design for a table, as shown and described.

DESCRIPTION

FIG. 1 is a front perspective view of a table in accordance with the present design;
 FIG. 2 is a rear perspective view of the table illustrated in FIG. 1;
 FIG. 3 is a front view of the table illustrated in FIG. 1;
 FIG. 4 is a rear view of the table illustrated in FIG. 1;
 FIG. 5 is a right side view of the table illustrated in FIG. 1;
 FIG. 6 is a left side view of the table illustrated in FIG. 1;
 FIG. 7 is a plan view of the table illustrated in FIG. 1; and,
 FIG. 8 is a bottom view of the table illustrated in FIG. 1.

1 Claim, 4 Drawing Sheets

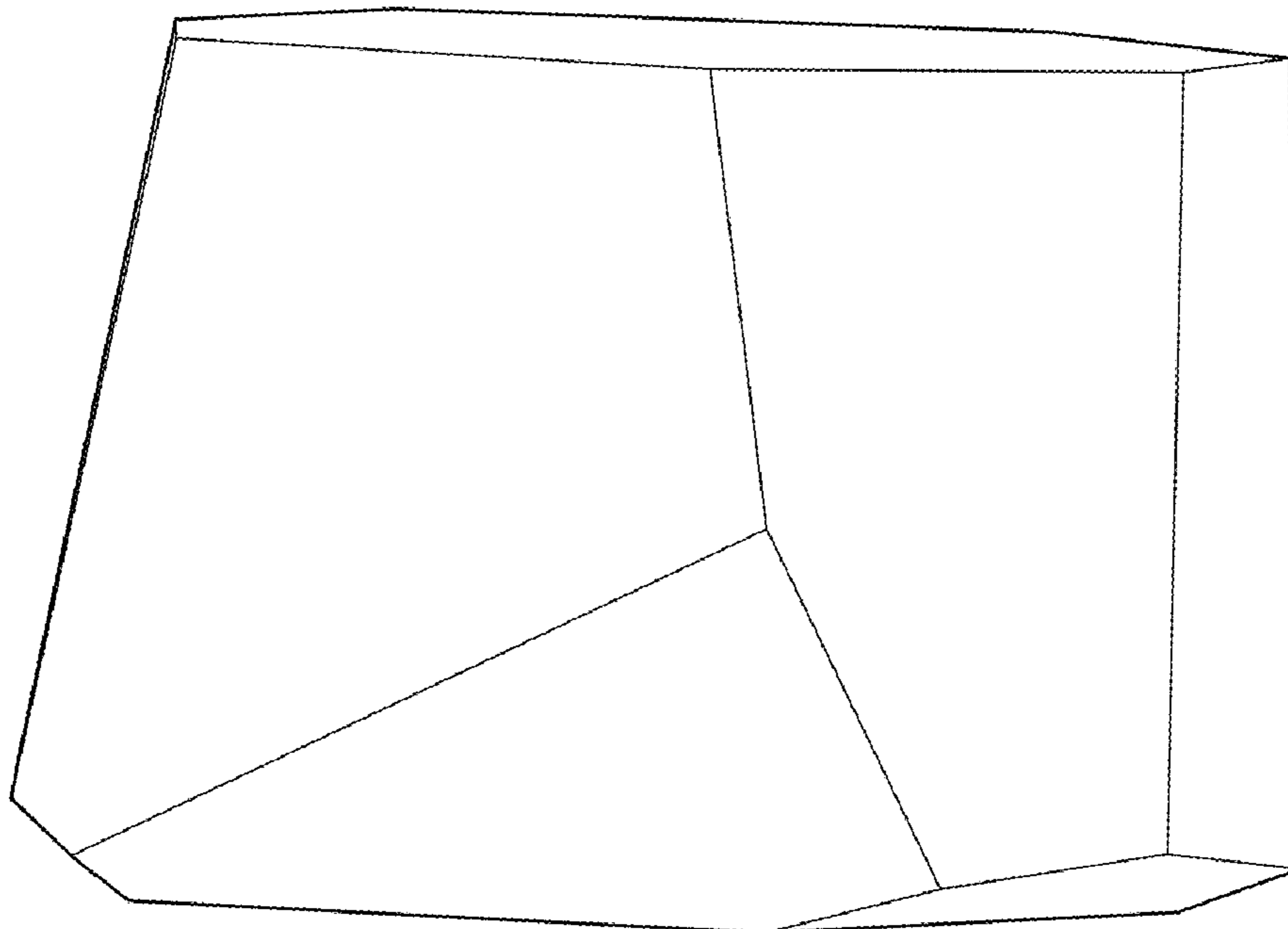

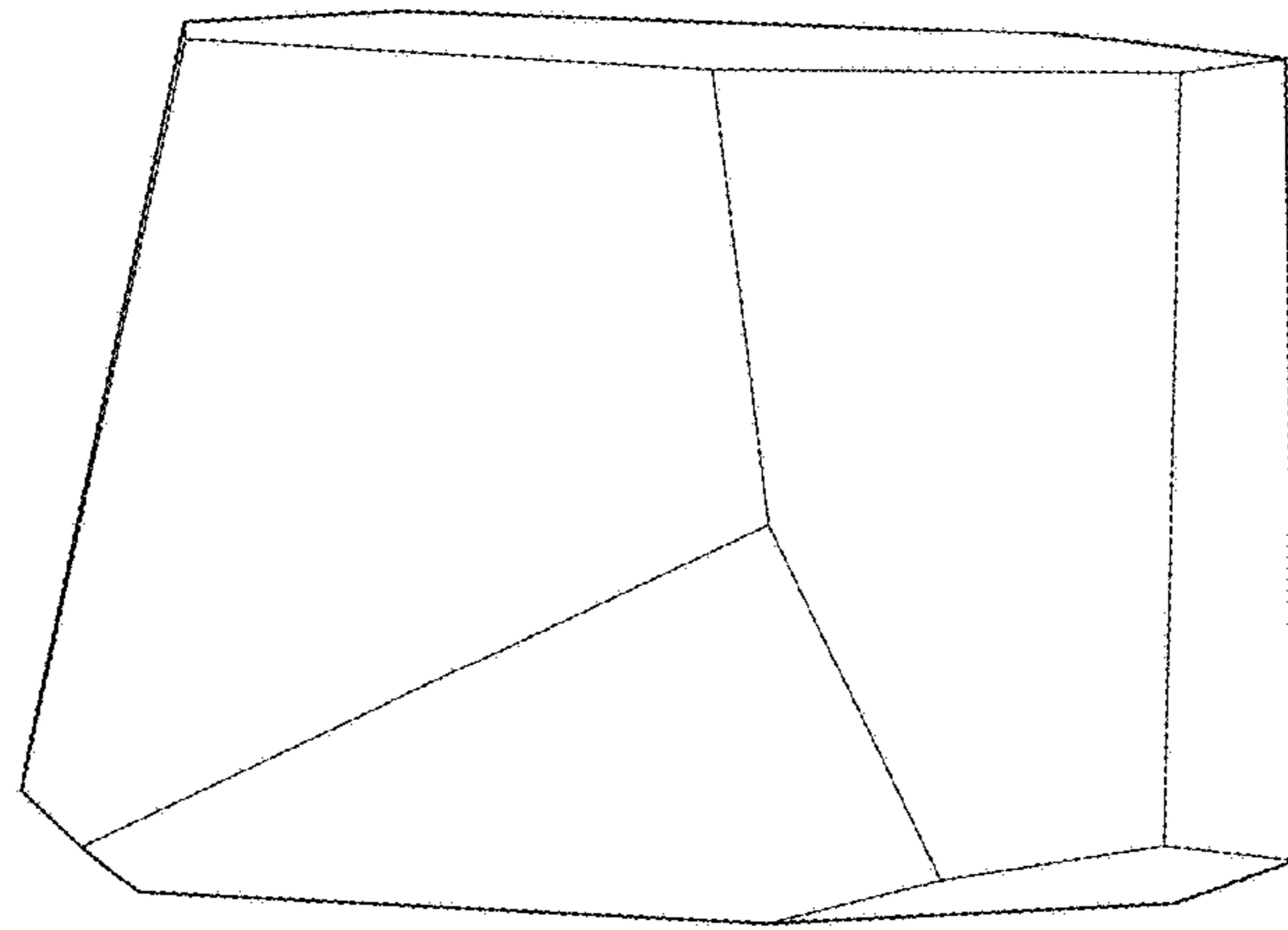

FIG. 1

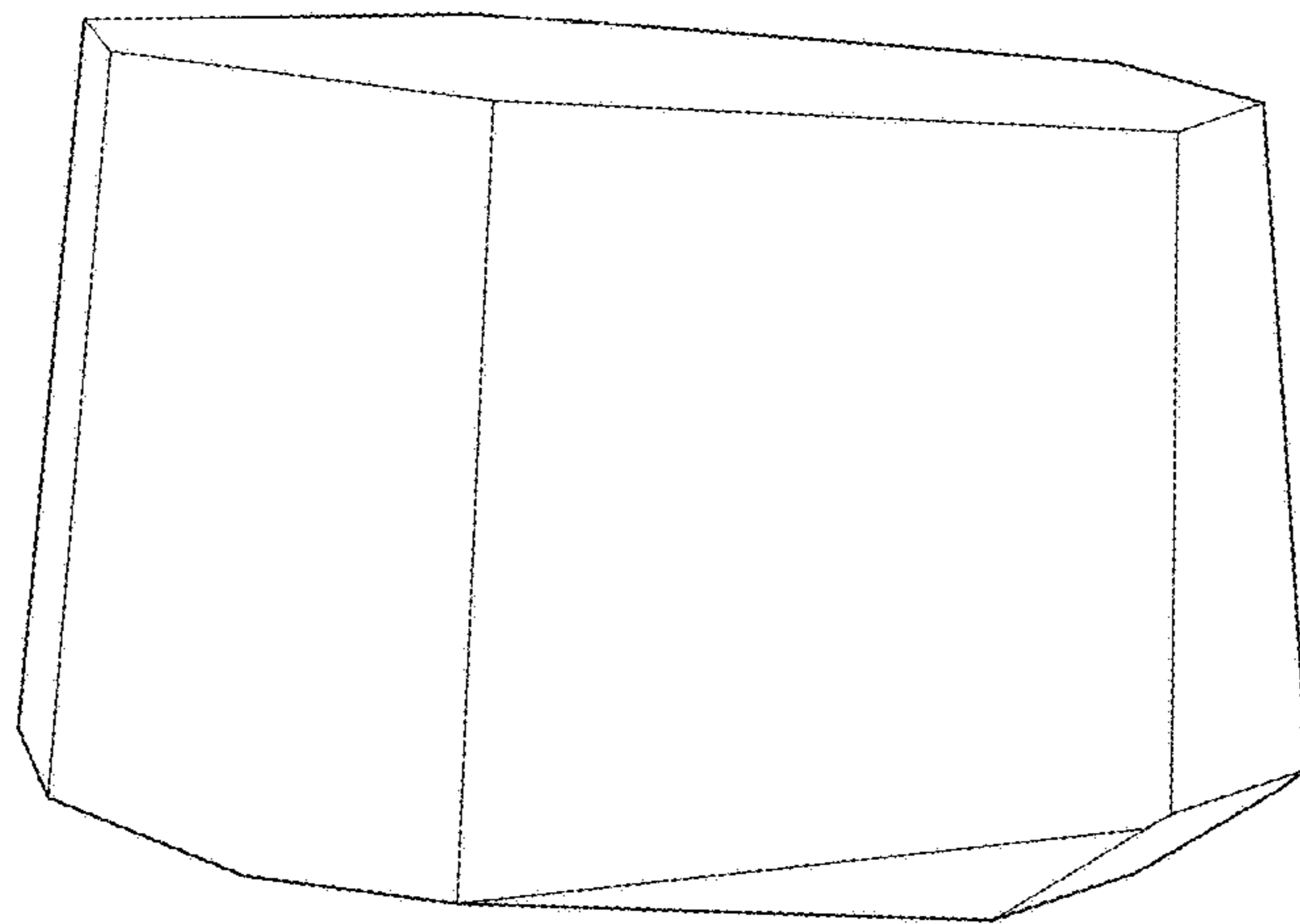

FIG. 2

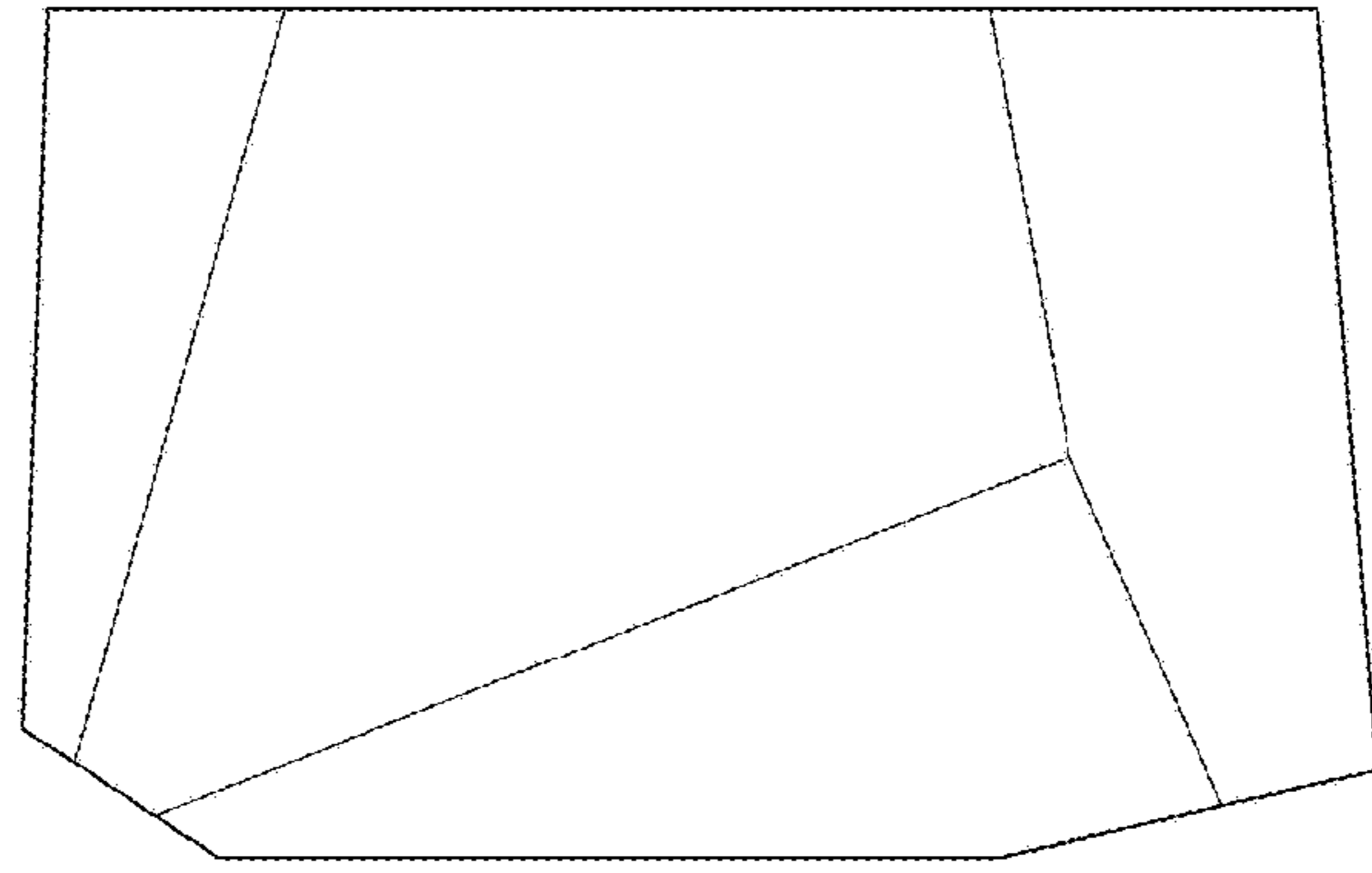

FIG. 3

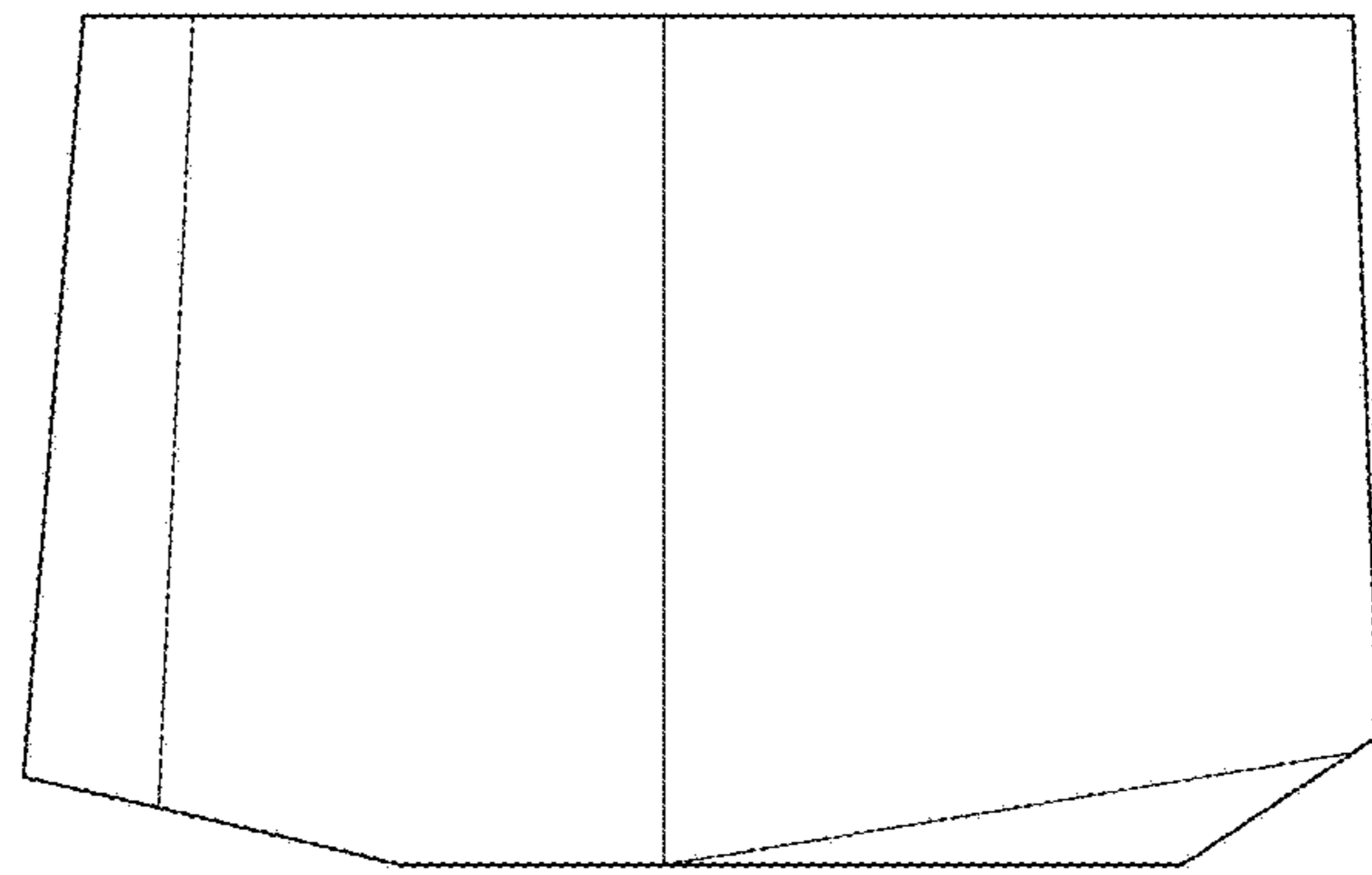

FIG. 4

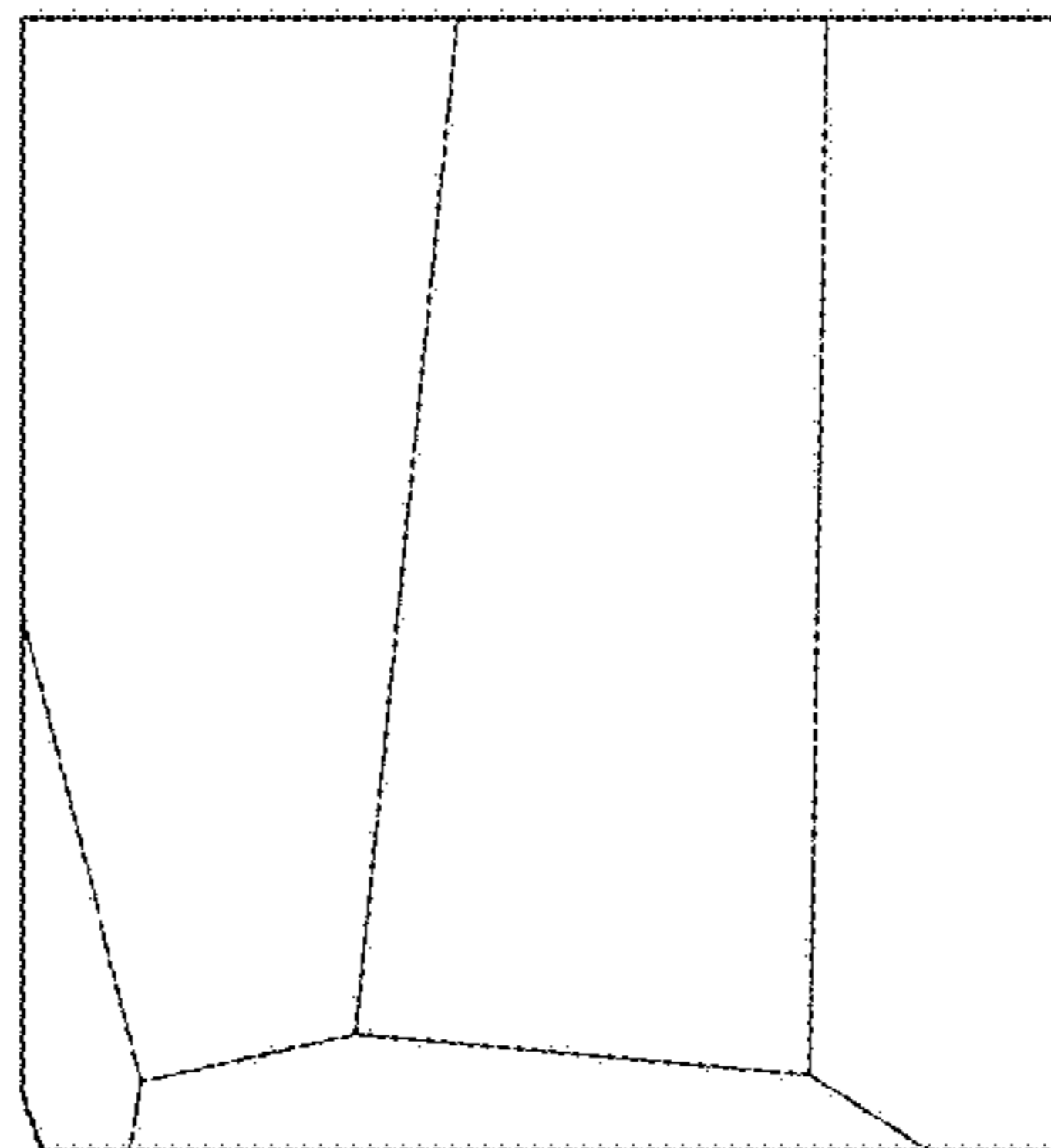

FIG. 5

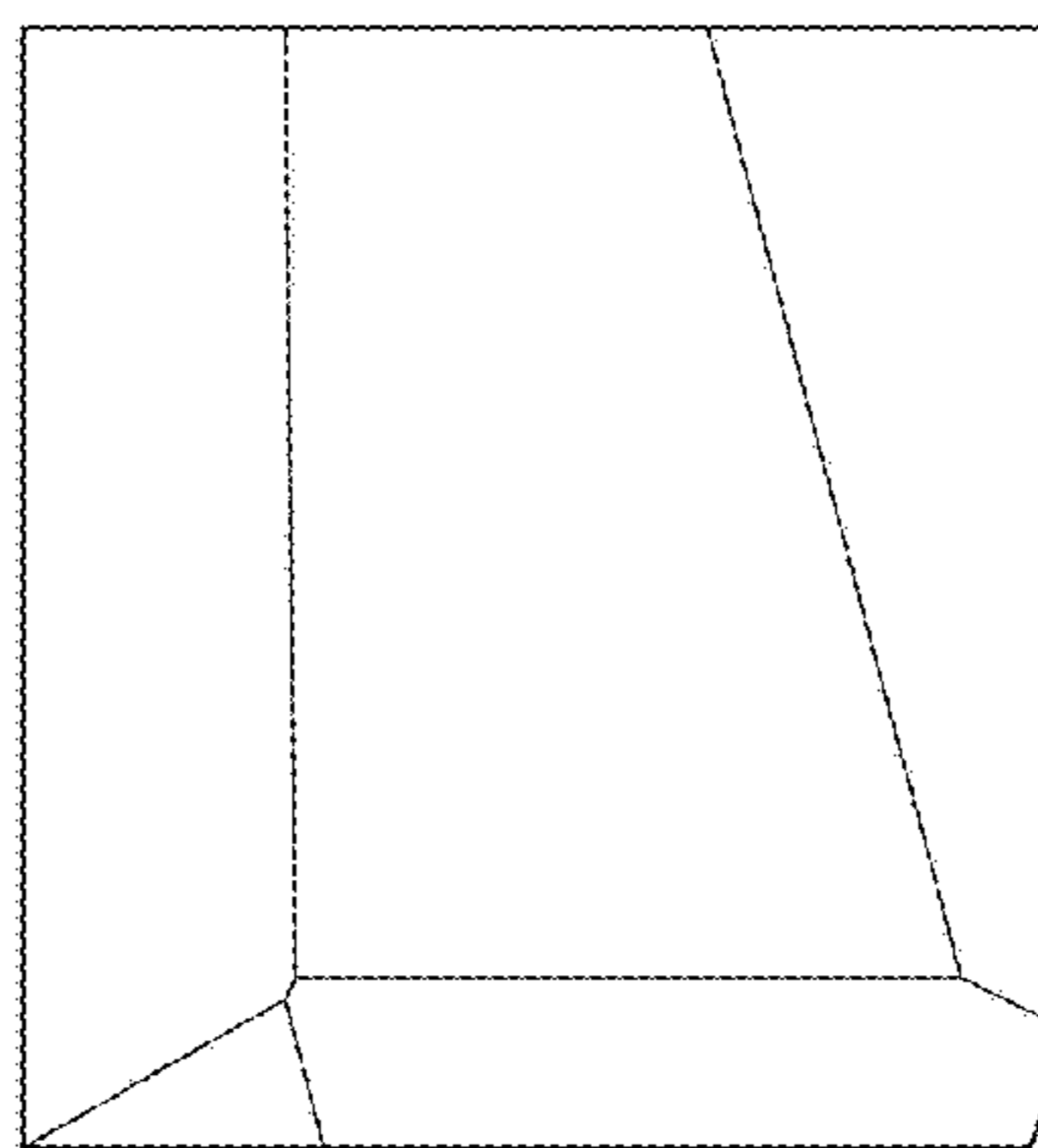

FIG. 6

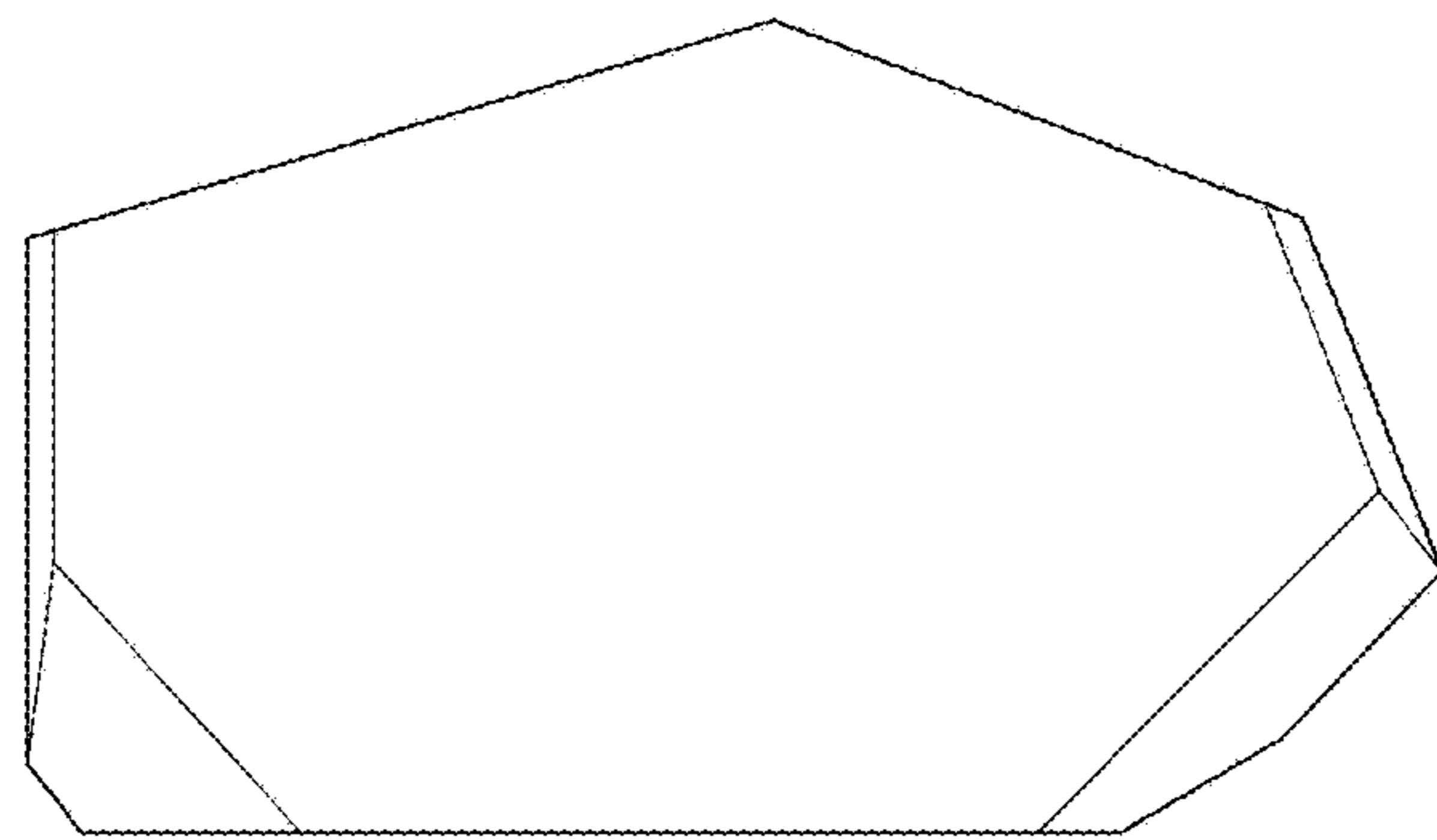

FIG. 7

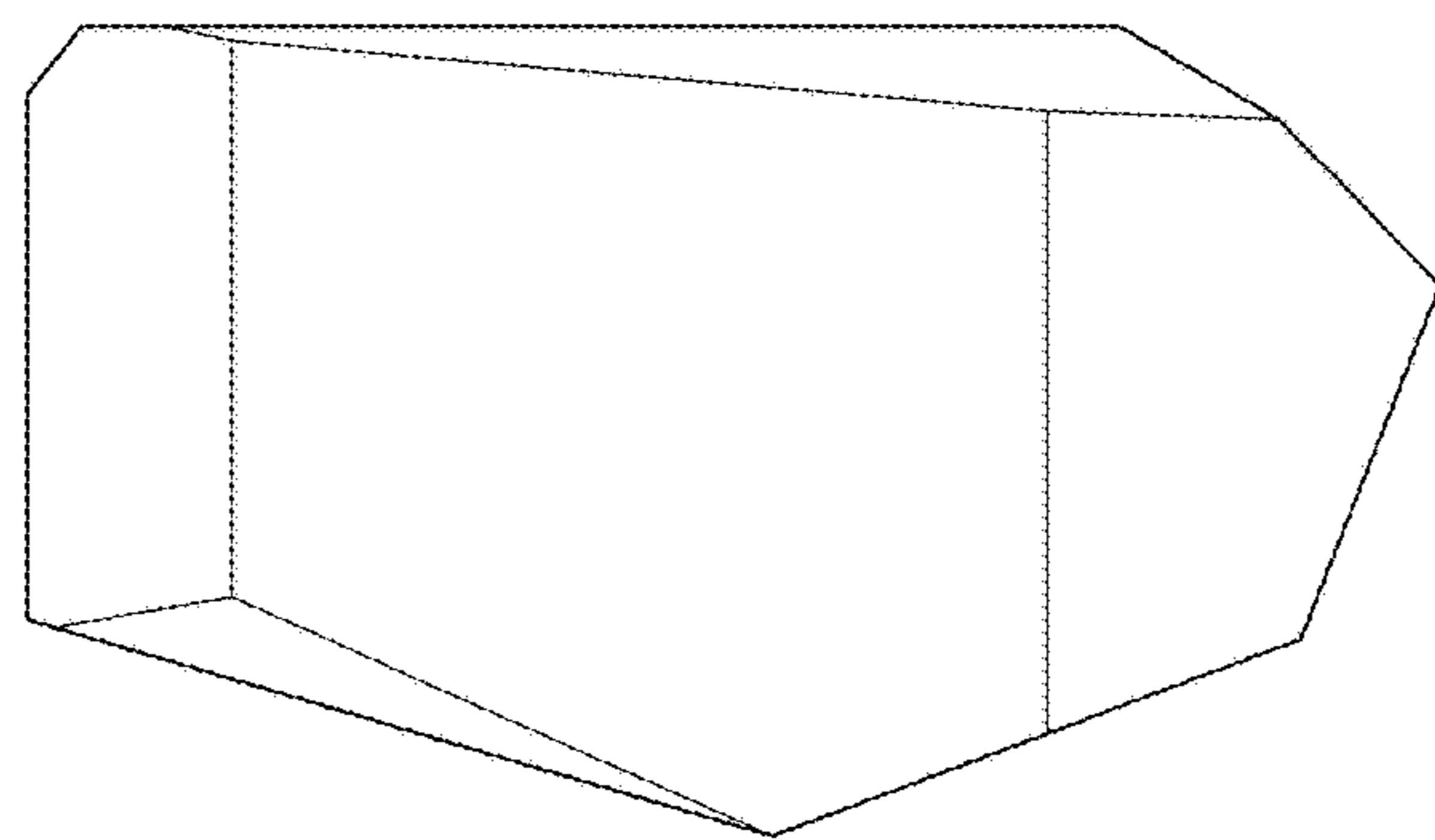

FIG. 8