



US00D846226S

(12) **United States Design Patent**  
**van Doorn**

(10) **Patent No.:** **US D846,226 S**  
(45) **Date of Patent:** **\*\* Apr. 16, 2019**

(54) **STAND FOR PALLETS**  
(71) Applicant: **AP STACKING B.V.**, AH Eindhoven  
(NL)  
(72) Inventor: **Glenn Hasan van Doorn**, Ar Winterle  
(NL)  
(73) Assignee: **AP STACKING B.V.**, Ah Eindhoven  
(NL)  
(\*\*) Term: **15 Years**

7,918,165 B2 \* 4/2011 Owen ..... B65D 19/385  
108/55.1  
D703,909 S \* 4/2014 Freeman ..... D34/38  
D713,114 S \* 9/2014 Etchegary ..... D34/38  
D748,887 S \* 2/2016 Macklin ..... D34/38  
D812,839 S \* 3/2018 Redding ..... D34/38  
2004/0129699 A1 \* 7/2004 Williams ..... B65D 11/1873  
220/4.31  
2009/0139942 A1 \* 6/2009 Andueza ..... A47B 81/007  
211/85.22  
2014/0299706 A1 \* 10/2014 DiSabantonio, III .. B65D 19/12  
242/598  
2018/0208358 A1 \* 7/2018 Ziemer ..... B65D 19/40

\* cited by examiner

(21) Appl. No.: **29/610,535**  
(22) Filed: **Jul. 13, 2017**

*Primary Examiner* — Cynthia Ramirez  
(74) *Attorney, Agent, or Firm* — Donald J. Ranft; Collen

(30) **Foreign Application Priority Data**  
Jan. 20, 2017 (WO) ..... DM/094 589  
(51) **LOC (11) Cl.** ..... **09-08**  
(52) **U.S. Cl.**  
USPC ..... **D34/38**  
(58) **Field of Classification Search**  
USPC ..... D34/38; 248/323, 126, 300  
CPC ..... B65D 19/002; B65D 19/12; B65D 19/40;  
B65D 19/385; B65D 2519/00333; B65D  
2519/00273; A47B 81/007  
See application file for complete search history.

(57) **CLAIM**  
The ornamental design for a stand for pallets, as shown and described.

(56) **References Cited**  
U.S. PATENT DOCUMENTS  
3,251,322 A \* 5/1966 Downs ..... B65D 19/002  
108/57.12  
D574,222 S \* 8/2008 Golias, Jr. .... D34/38  
D609,425 S \* 2/2010 Svedberg ..... D34/38

**DESCRIPTION**  
FIG. 1 is a front right perspective view of a stand for pallets showing my new design;  
FIG. 2 is a rear left perspective view thereof;  
FIG. 3 is a front view thereof;  
FIG. 4 is a rear view thereof;  
FIG. 5 is a left side view thereof;  
FIG. 6 is a right side view thereof;  
FIG. 7 is a top view thereof;  
FIG. 8 is a bottom view thereof; and,  
FIG. 9 is a perspective view of 2 connected stands for pallets thereof.  
The broken lines shown in FIG. 9 are for the purpose to show environment and form no part of the claimed design.

**1 Claim, 7 Drawing Sheets**

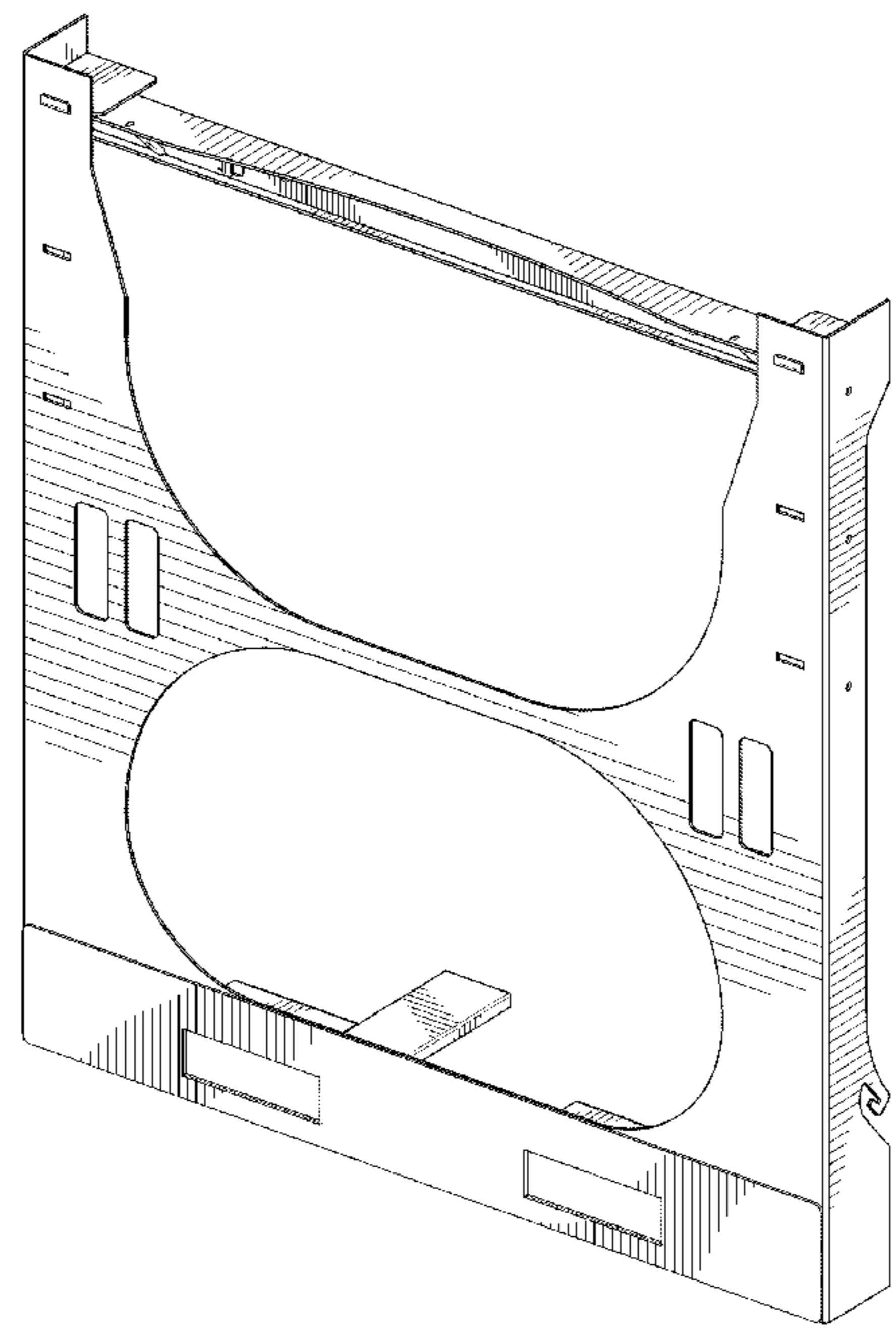

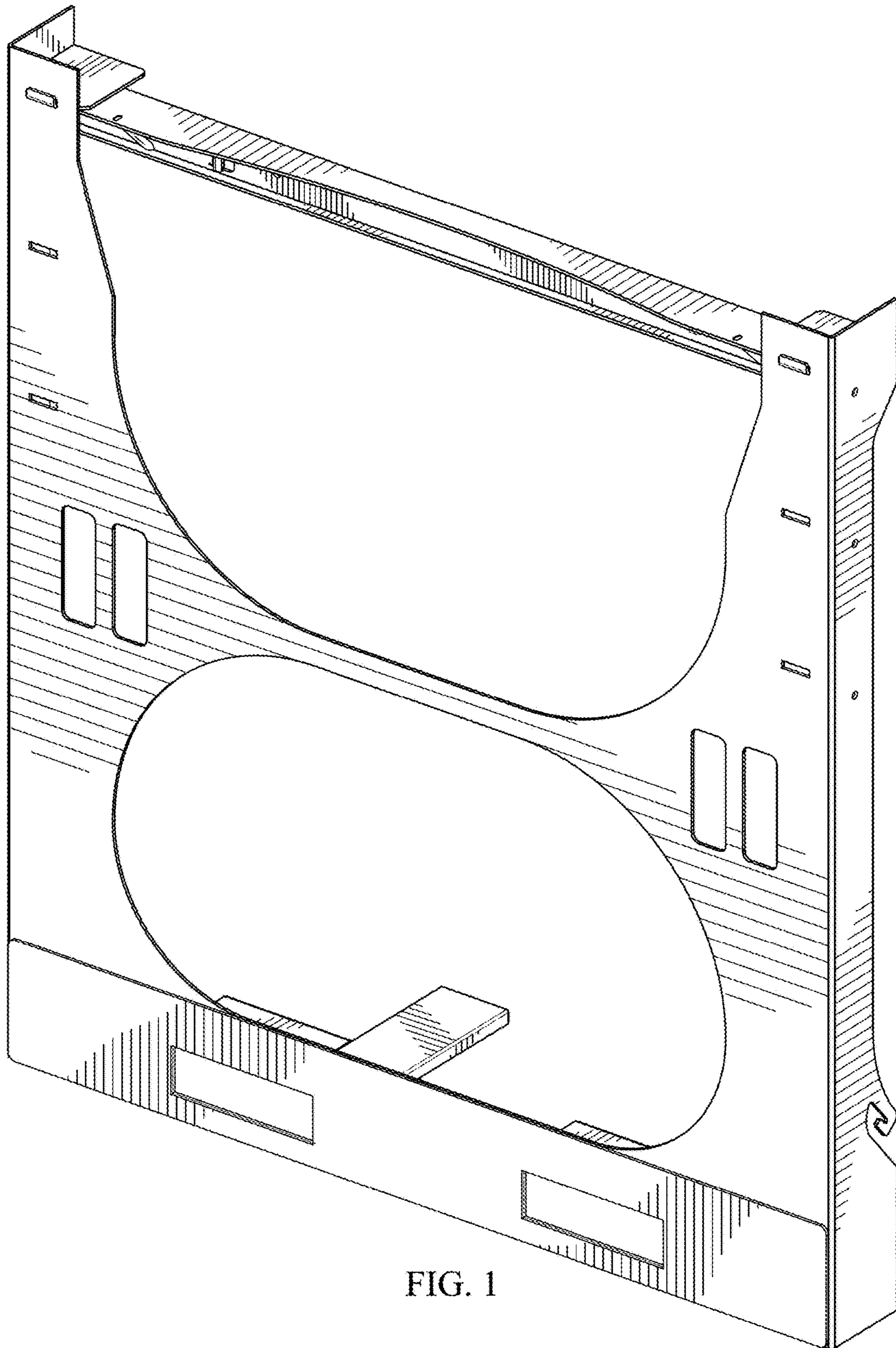

FIG. 1

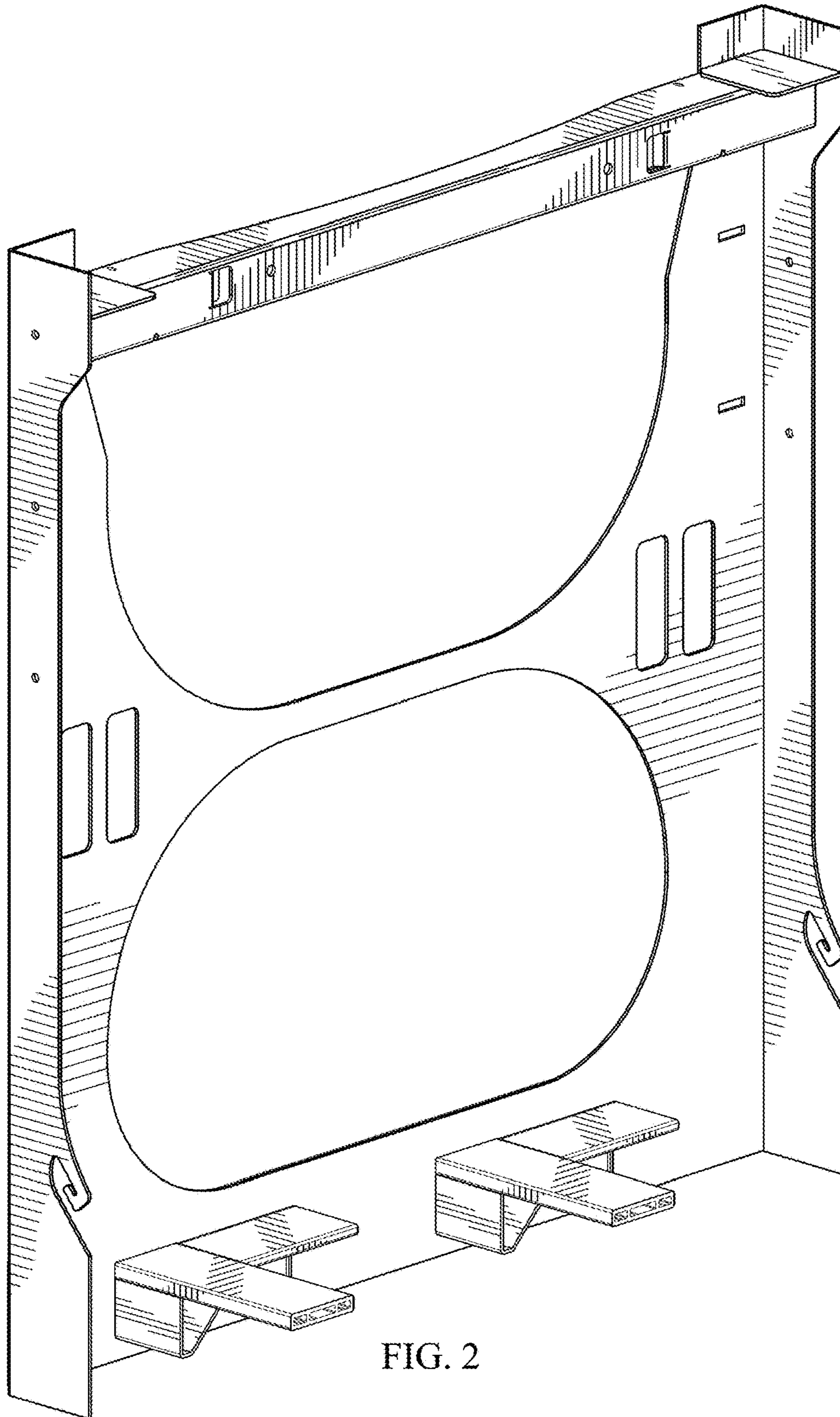

FIG. 2

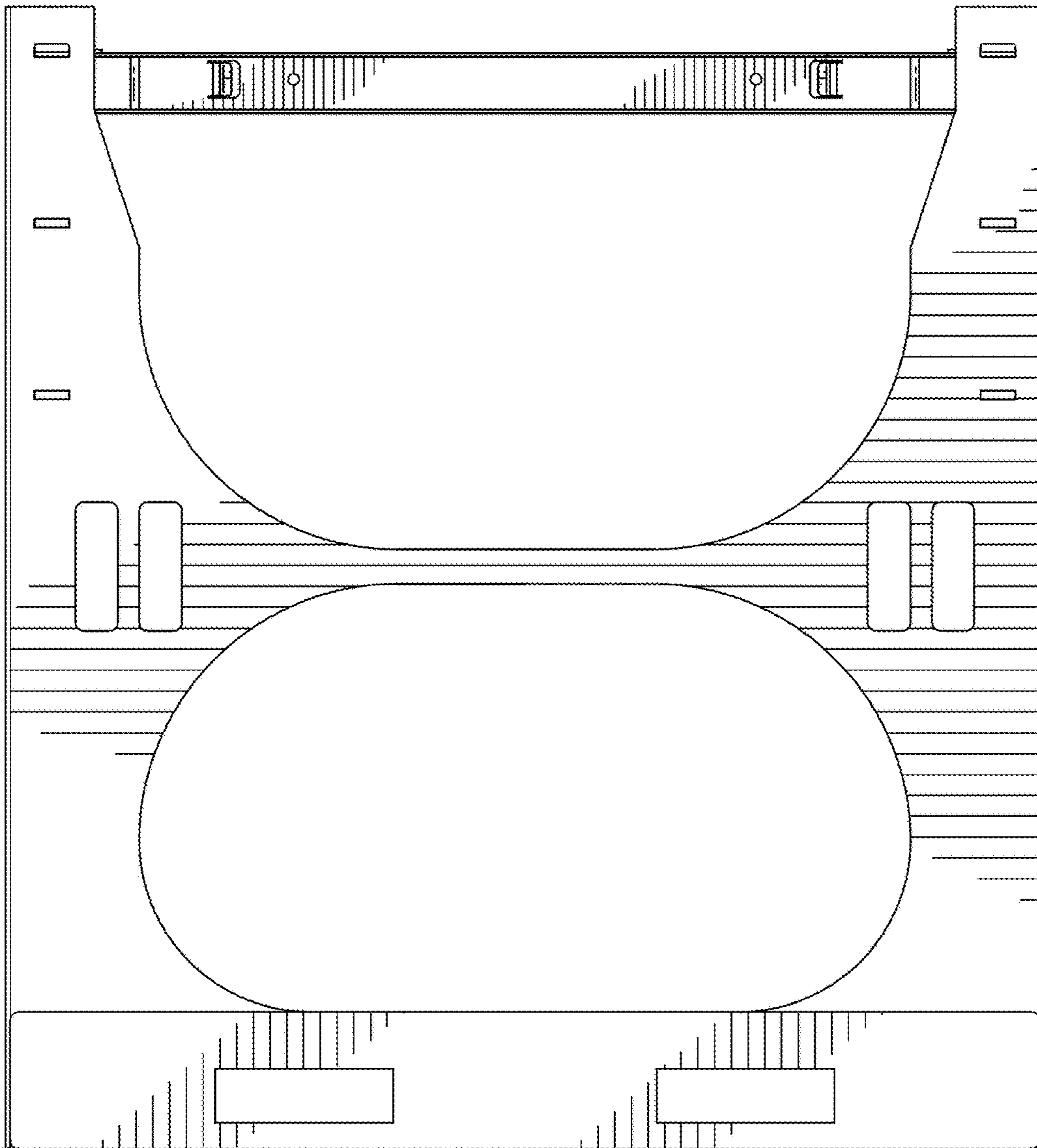

FIG. 3

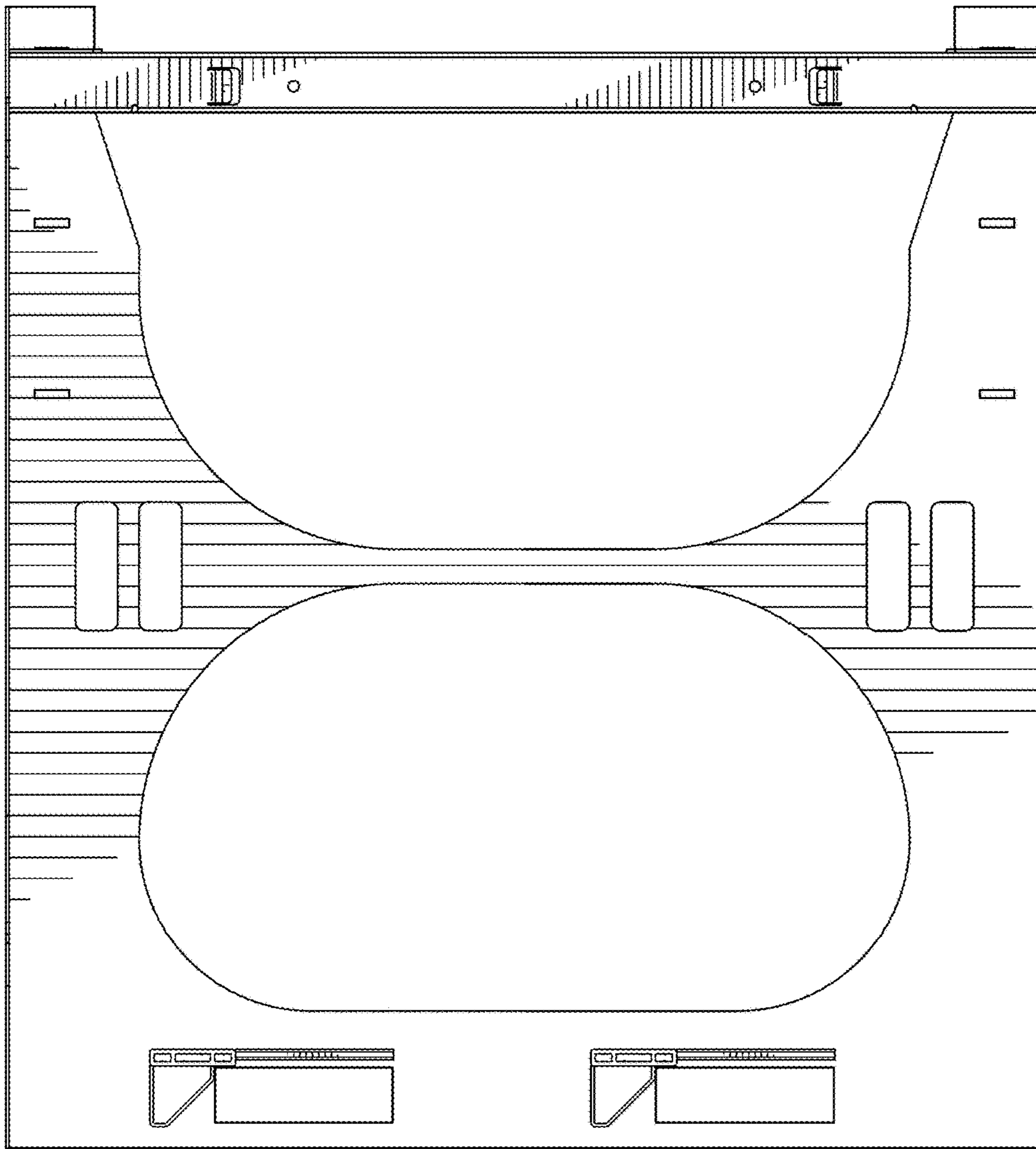

FIG. 4

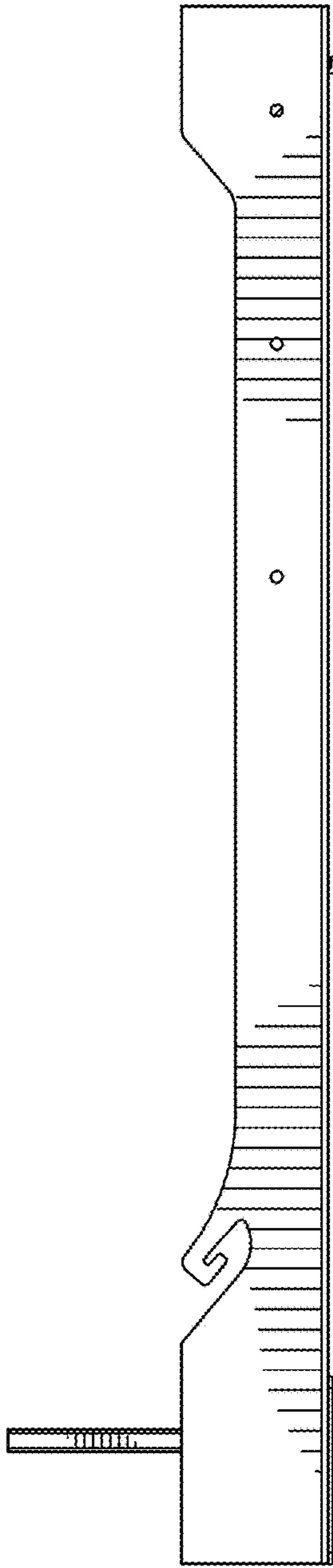

FIG. 5

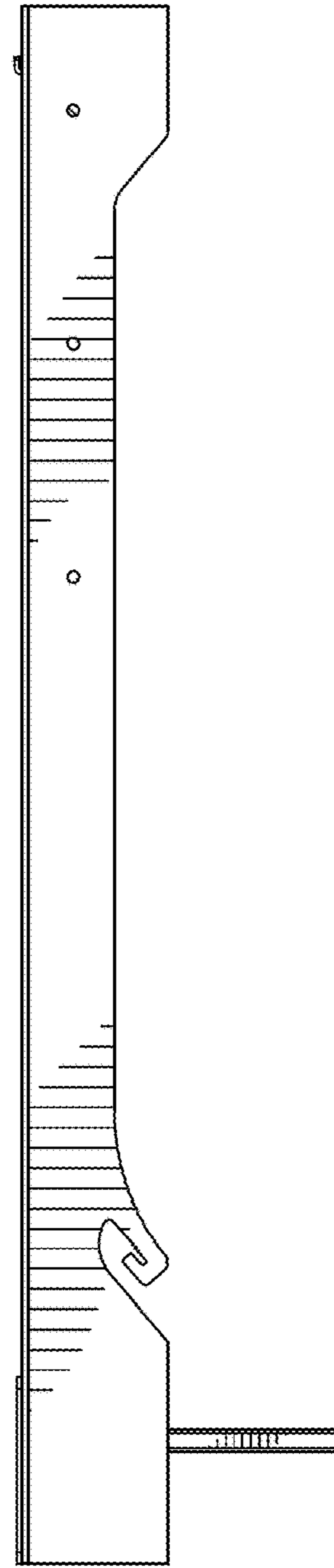

FIG. 6

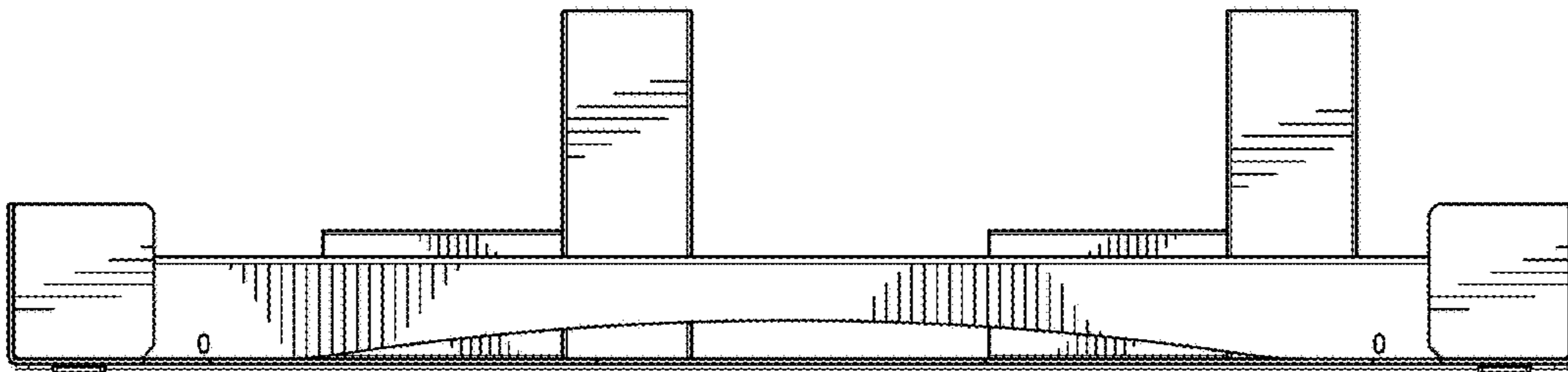

FIG. 7

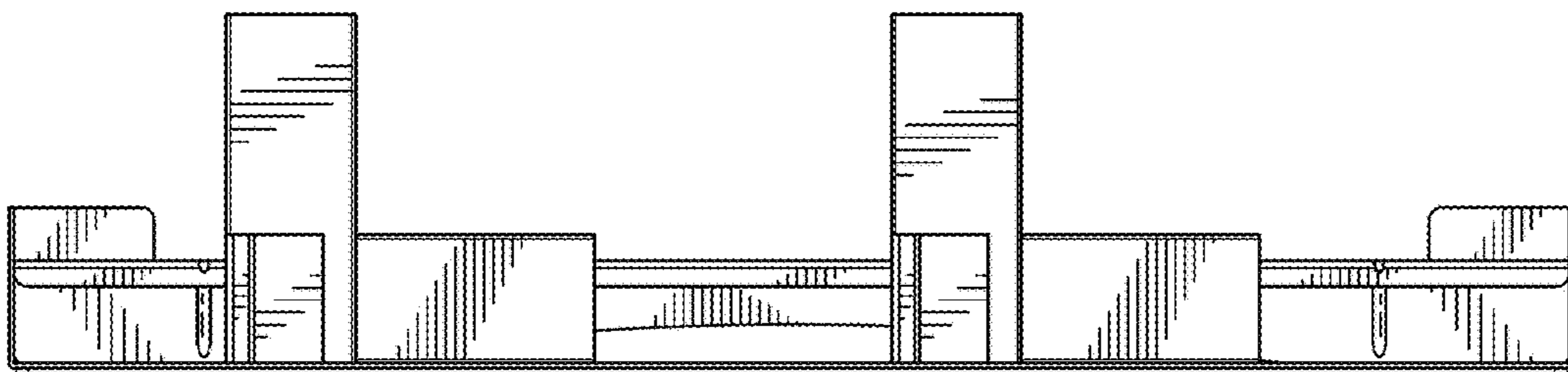

FIG. 8

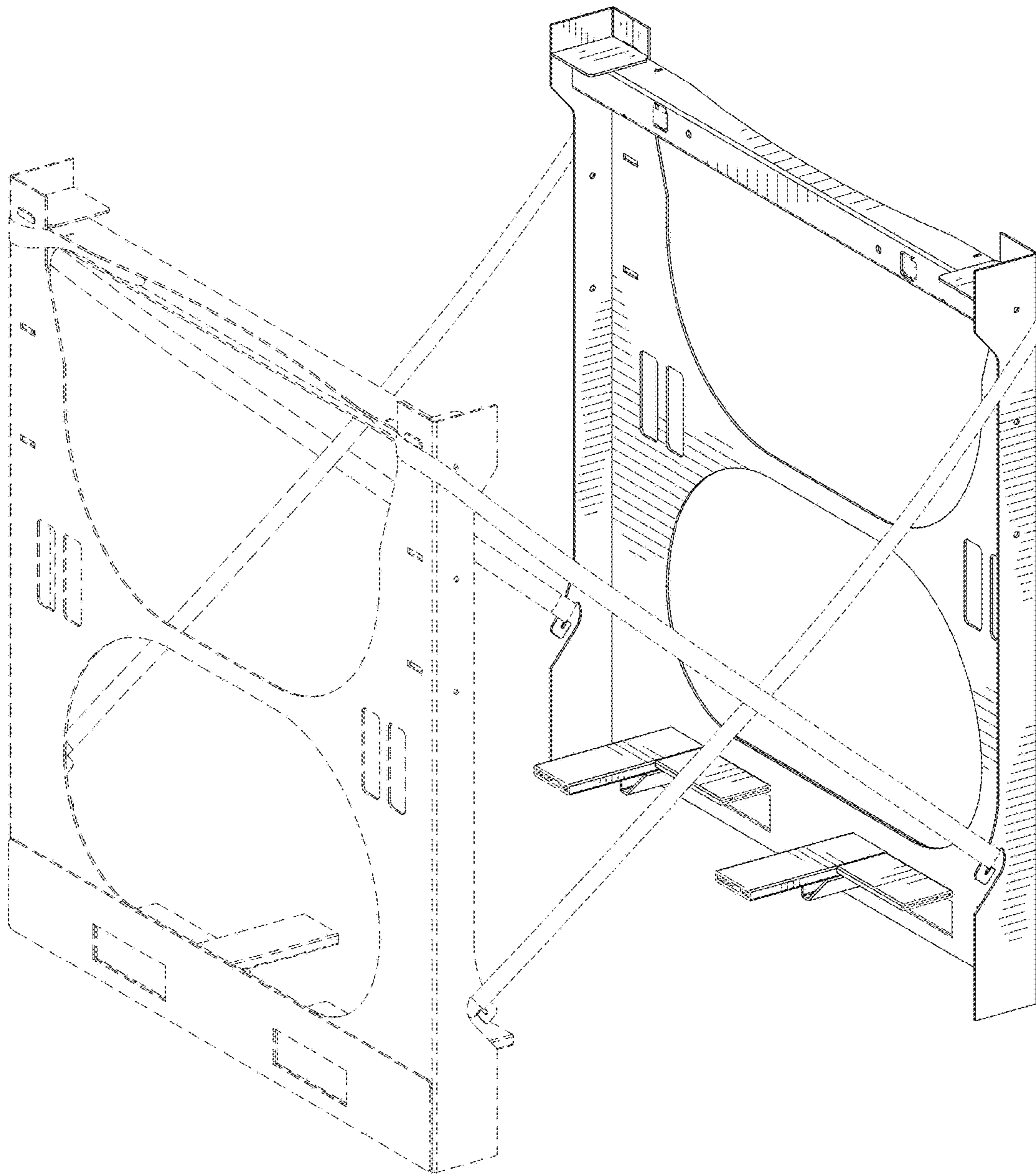

FIG. 9