



US00D846224S

(12) **United States Design Patent** (10) **Patent No.:** **US D846,224 S**  
**Yepifantsev** (45) **Date of Patent:** **\*\* Apr. 16, 2019**

(54) **RAMP SKID PLATE** 7,350,255 B2 \* 4/2008 Zhang ..... B65G 69/30  
14/69.5  
(71) Applicant: **Konstantin Yepifantsev**, Cookeville, 7,380,376 B2 6/2008 Ohno et al.  
TN (US) D588,716 S \* 3/2009 Meyer ..... D25/142  
D594,564 S 6/2009 Disch et al.  
(72) Inventor: **Konstantin Yepifantsev**, Cookeville, 8,333,042 B2 12/2012 Frederiksen  
TN (US) D793,024 S \* 7/2017 Bernart ..... D34/32  
D820,549 S \* 6/2018 Giannatti ..... D34/32  
2007/0196201 A1 \* 8/2007 Kennedy ..... B60P 1/43  
414/537

(\*\*) Term: **15 Years**

(21) Appl. No.: **29/592,557**

(22) Filed: **Jan. 31, 2017**

(51) **LOC (11) Cl.** ..... **12-05**

(52) **U.S. Cl.**  
USPC ..... **D34/35**

(58) **Field of Classification Search**  
USPC .... D34/32, 28, 33; D25/100, 114, 142, 143,  
D25/138, 62, 163, 153, 156; D5/1  
CPC .. B60P 1/435; B60P 1/43; B66F 7/243; B65G  
69/28

See application file for complete search history.

(56) **References Cited**

**U.S. PATENT DOCUMENTS**

2,281,822 A \* 5/1942 Bills ..... E04C 2/427  
52/180  
D246,388 S \* 11/1977 Shivvers ..... D25/142  
D253,968 S \* 1/1980 Bogan ..... D25/155  
D264,199 S \* 5/1982 Wood ..... D34/32  
D266,610 S \* 10/1982 Bartscher ..... D25/155  
D343,260 S \* 1/1994 Kovatch ..... D25/156  
5,645,394 A \* 7/1997 Hays ..... B60P 1/435  
414/537  
D401,731 S \* 11/1998 Jeruss ..... D34/32  
5,904,011 A 5/1999 Biro  
6,050,040 A 4/2000 Jones  
7,162,839 B2 1/2007 Ohno et al.  
D554,820 S \* 11/2007 Dretzka ..... D32/57

\* cited by examiner

*Primary Examiner* — Cynthia Ramirez

(74) *Attorney, Agent, or Firm* — Ridgeline Venture Law;  
Kevin Christopher

(57) **CLAIM**

The ornamental design for a ramp skid plate, as shown and described.

**DESCRIPTION**

FIG. 1 is a perspective view of a ramp skid plate showing my new design;  
FIG. 2 is a magnified sectional view of the area marked in FIG. 1;  
FIG. 3 is a top plan view thereof;  
FIG. 4 is a rear top plan view thereof;  
FIG. 5 is a right side elevation view thereof;  
FIG. 6 is a left side elevation view thereof;  
FIG. 7 is an end view thereof;  
FIG. 8 is the other end view thereof;  
FIG. 9 is a rear perspective view thereof; and,  
FIG. 10 is a magnified sectional view of the area marked in FIG. 9.

The broken lines in the figures define the bounds of the claimed design and form no part of the claimed design.

**1 Claim, 4 Drawing Sheets**

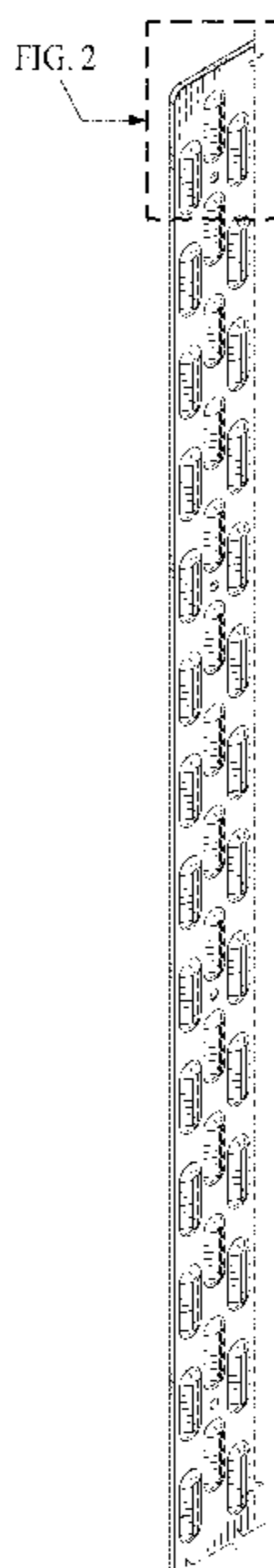

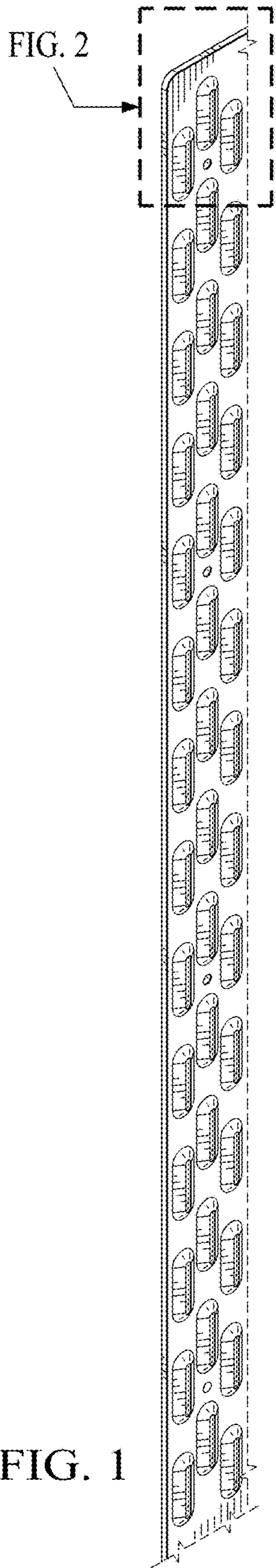

FIG. 1

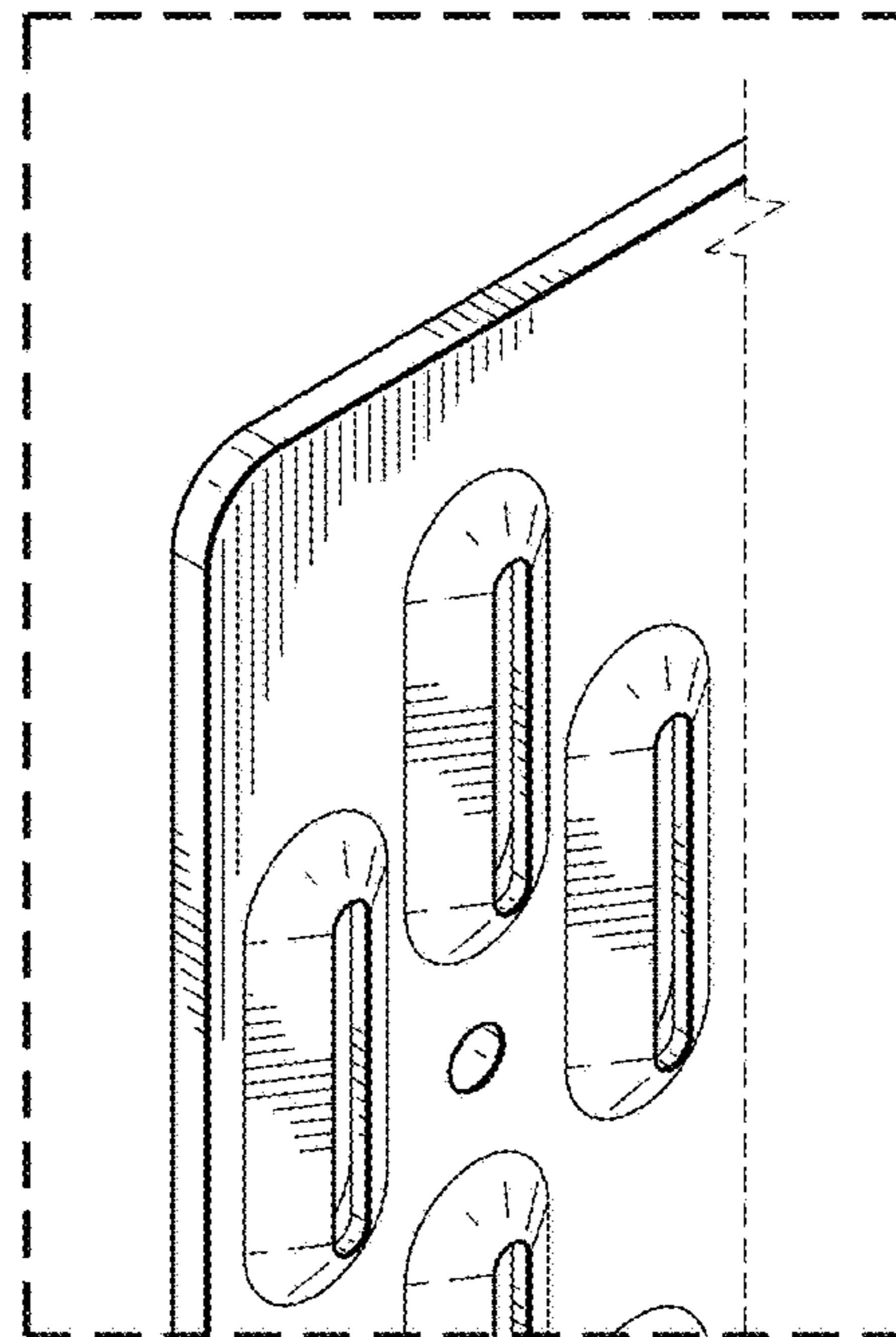

FIG. 2

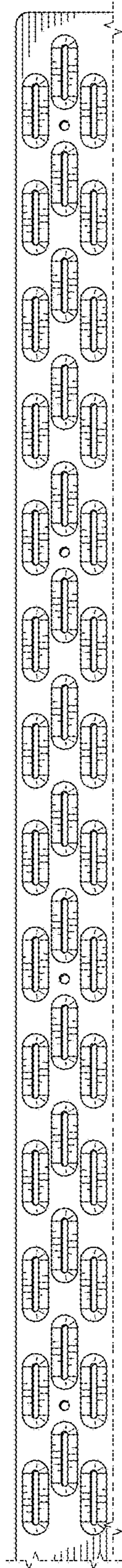

FIG. 3

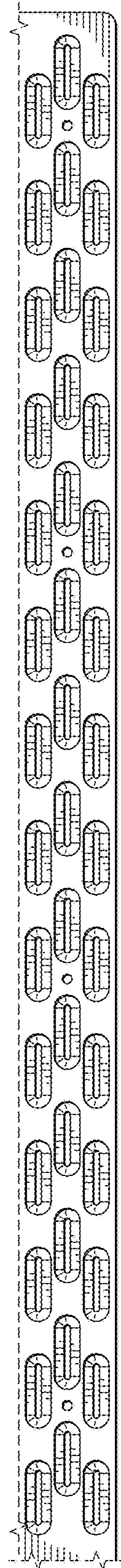

FIG. 4

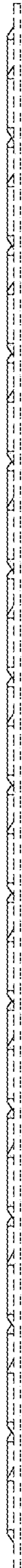

FIG. 5



FIG. 6

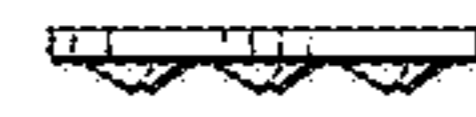

FIG. 7



FIG. 8

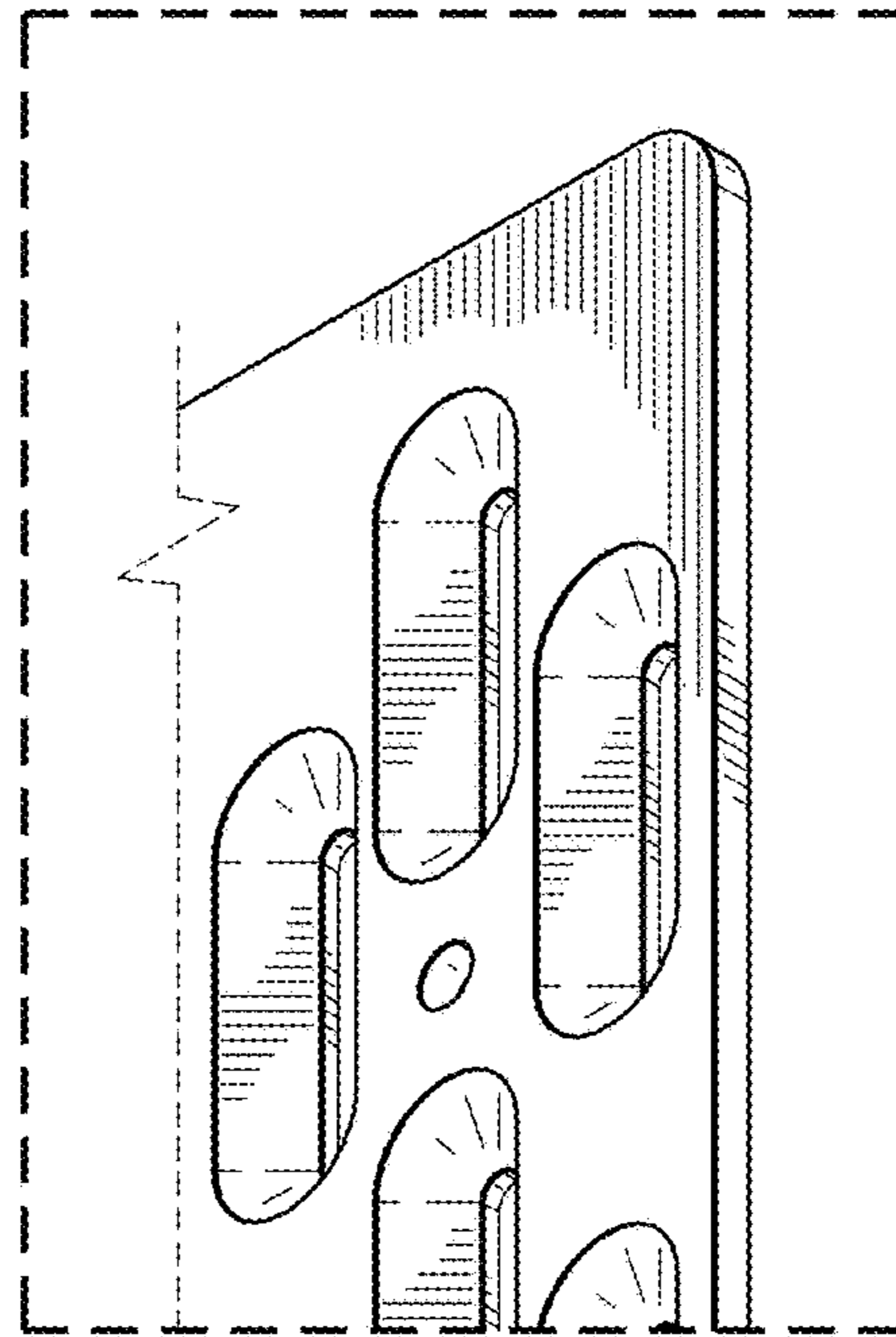
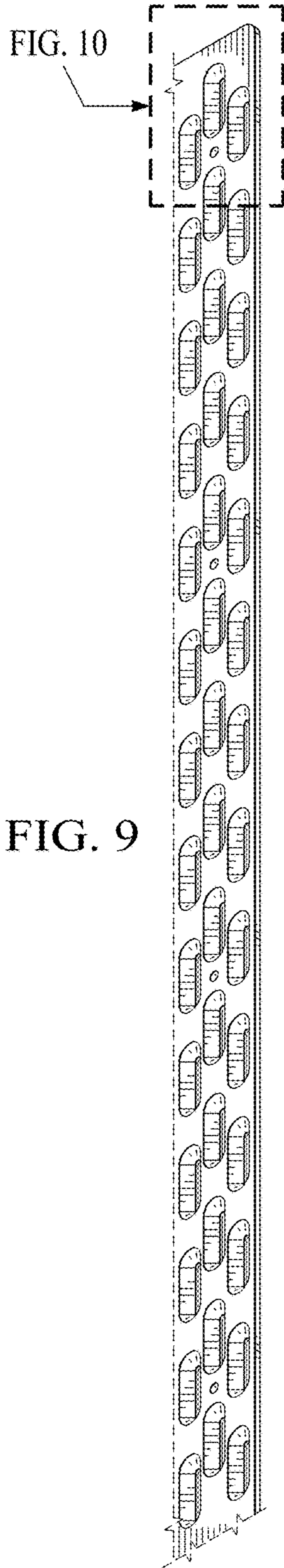

FIG. 10