



US00D846150S

(12) **United States Design Patent**
Li et al.

(10) **Patent No.:** **US D846,150 S**
(45) **Date of Patent:** **** Apr. 16, 2019**

(54) **ELEVATOR CAR**

- (71) Applicant: **OTIS ELEVATOR COMPANY**,
Farmington, CT (US)
- (72) Inventors: **Wei Li**, Hangzhou (CN); **Sisi Zheng**,
Hangzhou (CN); **Zhe Li**, Hangzhou
(CN)
- (73) Assignee: **OTIS ELEVATOR COMPANY**,
Farmington, CT (US)
- (**) Term: **15 Years**

(21) Appl. No.: **29/595,477**

(22) Filed: **Feb. 28, 2017**

(30) **Foreign Application Priority Data**

Aug. 29, 2016 (CN) 2016 3 0438517
 Aug. 29, 2016 (CN) 2016 3 0439106
 (Continued)

(51) **LOC (11) Cl.** **25-02**

(52) **U.S. Cl.**
USPC **D25/37**

(58) **Field of Classification Search**
USPC D25/37, 138, 149, 150, 157; D34/28, 33,
D34/35, 37

(Continued)

(56) **References Cited**

U.S. PATENT DOCUMENTS

1,616,096 A * 2/1927 Van Doorn B66B 11/0253
52/282.4
D84,604 S * 7/1931 Stegeman D25/37
(Continued)

FOREIGN PATENT DOCUMENTS

CN 301061463 * 11/2009
 CN 301161315 * 3/2010
 CN 302901364 * 8/2014

OTHER PUBLICATIONS

<http://otiselevatorbd.com/otis-passenger-lift/> Uploaded Dec. 2017
(Year: 2017).*

(Continued)

Primary Examiner — Leanne Was-Englehart
(74) *Attorney, Agent, or Firm* — Cantor Colburn LLP

(57) **CLAIM**

The ornamental design for an elevator car, as shown and described.

DESCRIPTION

The patent or application file contains at least one drawing executed in color. Copies of this patent or patent application publication with color drawing(s) will be provided by the Office upon request and payment of the necessary fee.

FIG. 1 is a perspective view of an elevator car showing our new design in an exemplary embodiment;

FIG. 2 is a rear view of the embodiment shown in FIG. 1;

FIG. 3 is a front view of the embodiment shown in FIG. 1;

FIG. 4 is a side view of the embodiment shown in FIG. 1;

FIG. 5 is another side view of the embodiment shown in FIG. 1;

FIG. 6 is a top view of the embodiment shown in FIG. 1;

FIG. 7 is a bottom view of the embodiment shown in FIG. 1;

FIG. 8 is a perspective view of an elevator car showing our new design in an exemplary embodiment;

FIG. 9 is a rear view of the embodiment shown in FIG. 8;

FIG. 10 is a front view of the embodiment shown in FIG. 8;

FIG. 11 is a side view of the embodiment shown in FIG. 8;

FIG. 12 is another side view of the embodiment shown in FIG. 8;

FIG. 13 is a top view of the embodiment shown in FIG. 8;

and,

FIG. 14 is a bottom view of the embodiment shown in FIG. 8.

The broken lines in the figures are for environmental purposes only and form no part of the claimed design.

1 Claim, 12 Drawing Sheets
(10 of 12 Drawing Sheet(s) Filed in Color)

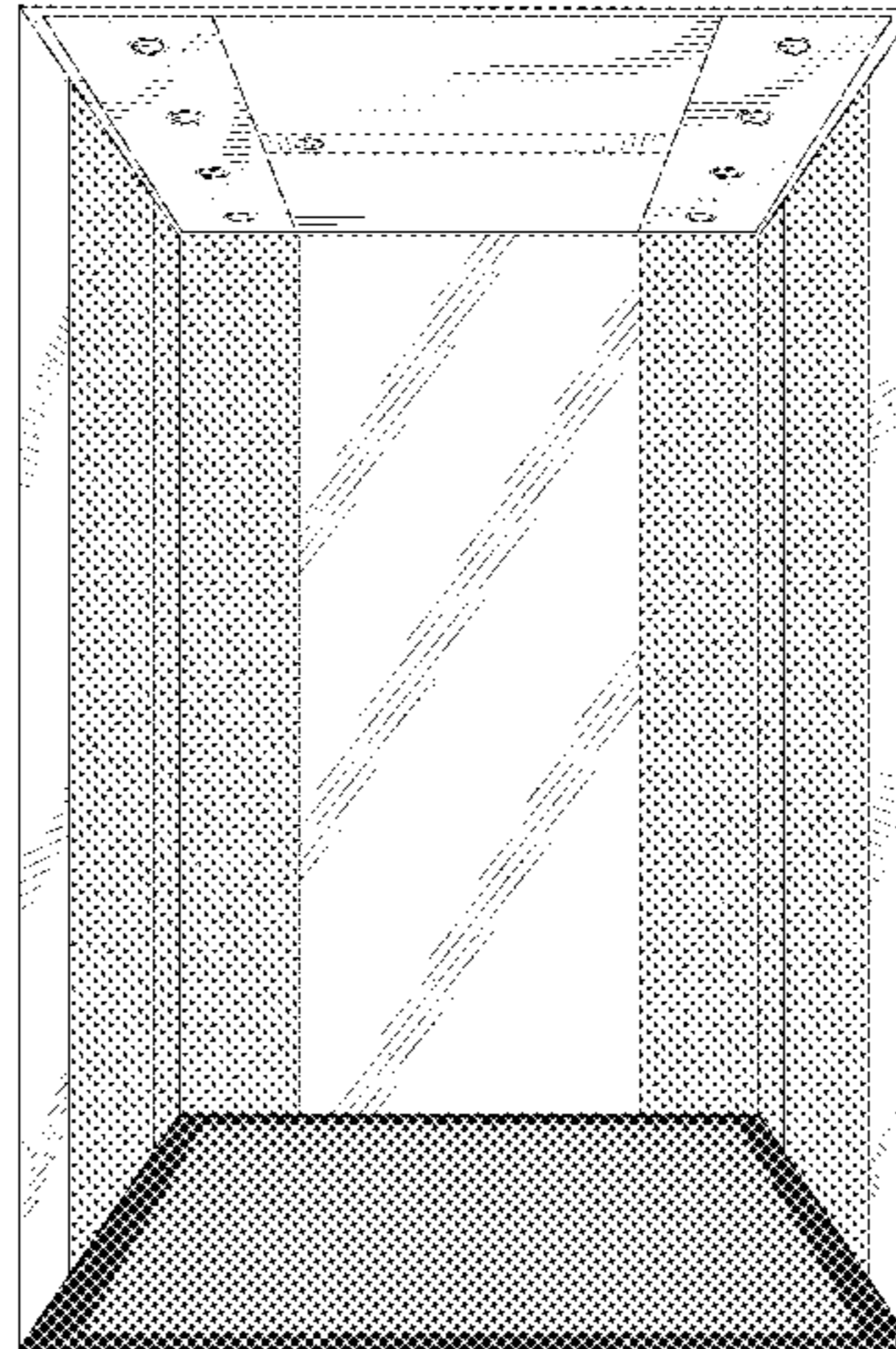
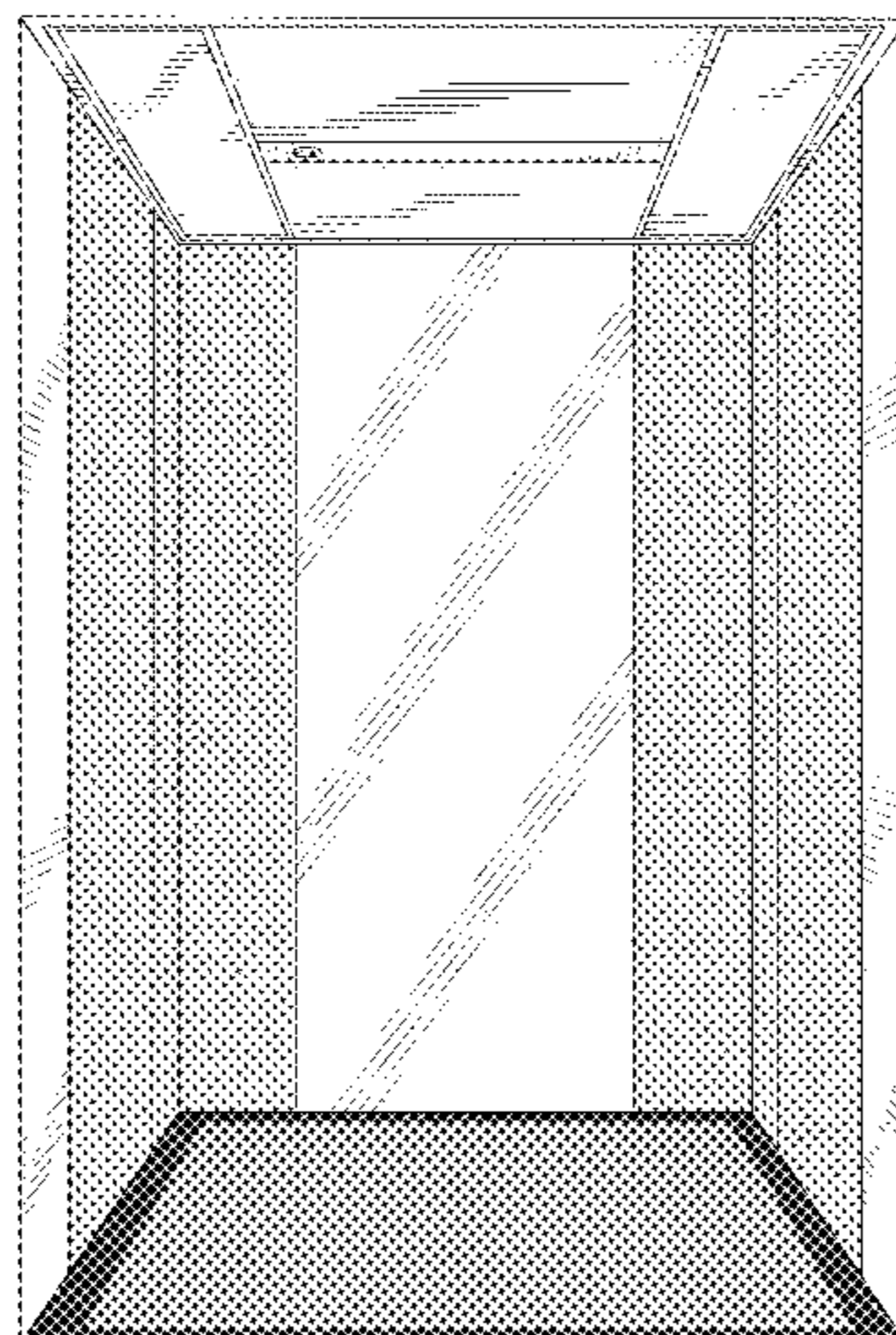

(30) **Foreign Application Priority Data**

Aug. 29, 2016 (CN) 2016 3 0439140
 Aug. 29, 2016 (CN) 2016 3 0439157

(58) **Field of Classification Search**

CPC B66B 11/0226; B66B 11/0233; B66B
 11/0253; B66B 1/461; B66B 1/466; B66B
 3/00; B66B 3/008; E04B 9/04; E04F
 13/081; E04F 13/0846; E04C 2/384
 See application file for complete search history.

(56) **References Cited**

U.S. PATENT DOCUMENTS

2,206,075 A * 7/1940 Campbell B66B 11/0253
 52/261
 D195,117 S * 4/1963 Brounn D25/37
 3,103,708 A * 9/1963 Pomeroy B66B 11/0253
 410/107
 3,282,004 A * 11/1966 Brounn B66B 11/0226
 52/269
 3,383,820 A * 5/1968 Kates E04C 2/384
 52/475.1
 D223,340 S * 4/1972 Brounn D25/37
 D250,278 S * 11/1978 Hesford D25/157
 4,704,662 A * 11/1987 Makino B66B 11/0233
 362/147
 4,709,308 A * 11/1987 Makino B66B 11/0233
 362/148
 4,711,322 A * 12/1987 Orndorff E04B 9/18
 187/401
 4,712,651 A * 12/1987 Sherwood B66B 11/0233
 187/401
 4,749,061 A * 6/1988 Orndorff B66B 11/0233
 187/401
 4,875,552 A * 10/1989 Smith B66B 11/0226
 160/135
 5,412,542 A * 5/1995 Mandy B66B 11/0233
 187/390
 5,862,889 A * 1/1999 Sevilleja B66B 1/466
 187/395
 6,161,654 A * 12/2000 Sirigu B66B 3/00
 187/391
 D461,563 S * 8/2002 Fayol D25/37
 D465,285 S * 11/2002 Fayol D25/37
 2003/0006102 A1 * 1/2003 Bloch B66B 11/0233
 187/414
 2004/0052070 A1 * 3/2004 Mandy B66B 11/0233
 362/147
 2008/0296100 A1 * 12/2008 Lee B66B 11/0226
 187/401

2012/0106138 A1 * 5/2012 Mandy B66B 11/0233
 362/147
 2012/0181116 A1 * 7/2012 Chasteen B66B 1/34
 187/392
 2012/0181117 A1 * 7/2012 Chasteen B66B 11/0233
 187/392

OTHER PUBLICATIONS

<http://www.safelevator.net/project/car-cabin/> Uploaded Sep. 2015
 (Year: 2015).
 Examination Report; European Union Application Nos. 003773688-
 0001/003773688-0008; dated Mar. 9, 2017; 6 Pages.
 Notification to Grant Patent Right for Design and the Notification to
 Go Through Formalities of Registration; Chinese Application No.
 201630438517.9; dated Apr. 26, 2017; 6 Pages.
 Notification to Grant Patent Right for Design and the Notification to
 Go Through Formalities of Registration; Chinese Application No.
 201630439106.1; dated May 4, 2017; 6 Pages.
 Notification to Grant Patent Right for Design and the Notification to
 Go Through Formalities of Registration; Chinese Application No.
 201630439140.9; dated May 8, 2017; 6 Pages.
 Notification to Grant Patent Right for Design and the Notification to
 Go Through Formalities of Registration; Chinese Application No.
 201630439157.4; dated Jul. 27, 2017; 6 Pages.
 Notification to Make Rectification (2nd); Chinese Application No.
 201630439157.4; dated Jan. 18, 2017; 2 Pages.
 Notification to Make Rectification (2nd); Chinese Application No.
 201630438517.9; dated Jan. 18, 2017; 2 Pages.
 Notification to Make Rectification (2nd); Chinese Application No.
 201630439106.1; dated Jan. 18, 2017; 3 Pages.
 Notification to Make Rectification (2nd); Chinese Application No.
 201630439140.9; dated Jan. 18, 2017; 4 Pages.
 Notification to Make Rectification; Chinese Application No.
 201630438517.9; dated Nov. 18, 2016; 4 Pages.
 Notification to Make Rectification; Chinese Application No.
 201630439106.1; dated Nov. 14, 2016; 4 Pages.
 Notification to Make Rectification; Chinese Application No.
 201630439140.9; dated Nov. 14, 2016; 4 Pages.
 Notification to Make Rectification; Chinese Application No.
 201630439157.4; dated Nov. 14, 2016; 2 Pages.
 Daemyung Elevator Co., Ltd.; "GLiftValley"; URL Accessed: [http://
 gliftvalley.com/en/directory/daemyung-elevator-co-ltd/#pret-
 tyPhoto](http://gliftvalley.com/en/directory/daemyung-elevator-co-ltd/#prettyPhoto); Available Oct. 2, 2016 (Year: 2016); 5 Pages.
 Non-Final Office Action; U.S. Appl. No. 29/595,480, filed Feb. 28,
 2017; Elevator Car Decoration; dated Apr. 3, 2018; 17 Pages.
 Restriction Requirement; U.S. Appl. No. 29/595,465, filed Feb. 28,
 2017; Elevator Car Decoration; dated Apr. 2, 2018; 18 Pages.
 Restriction Requirement; U.S. Appl. No. 29/595,471, filed Feb. 28,
 2017; Elevator Car Decoration; dated Apr. 3, 2018; 18 Pages.

* cited by examiner

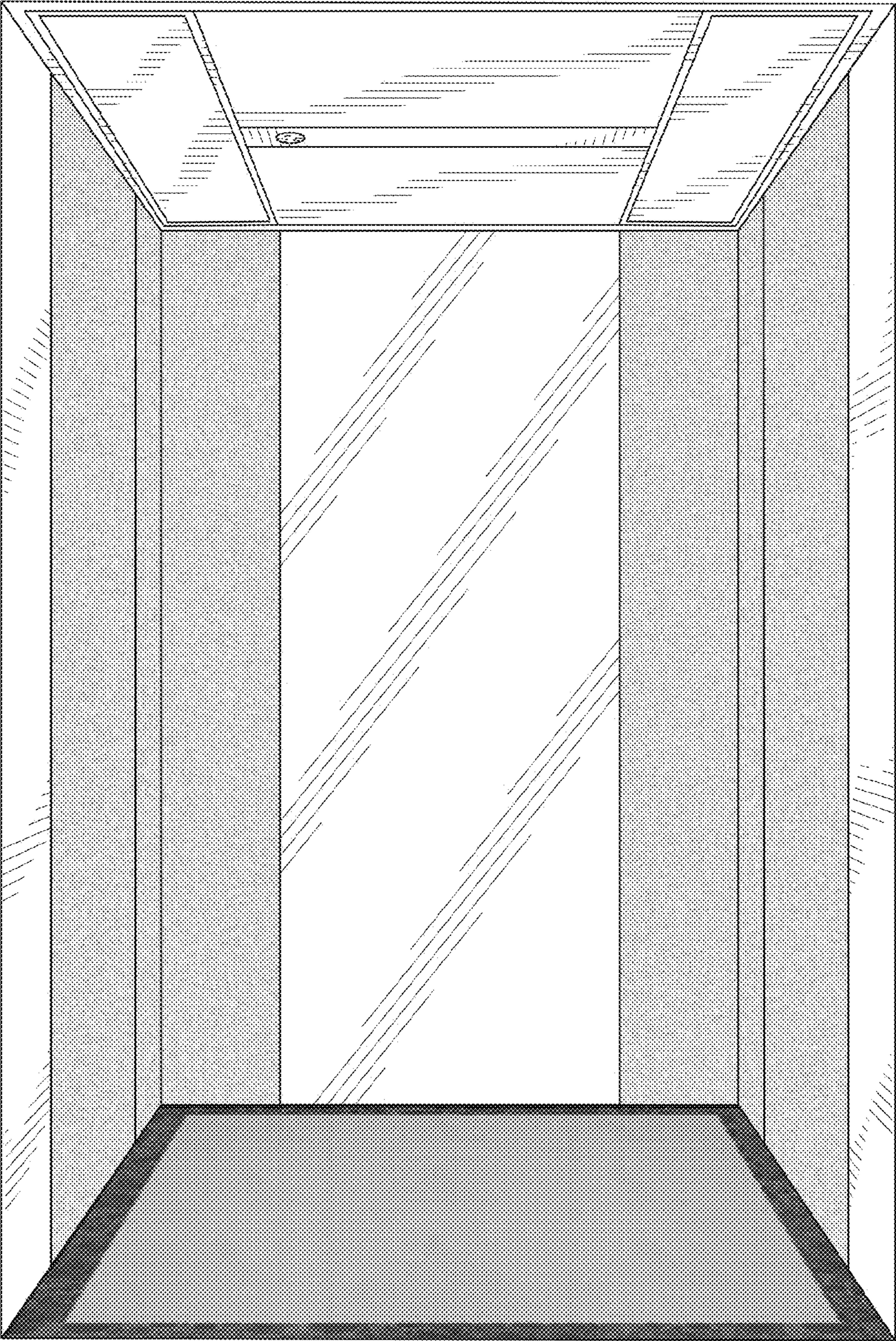

FIG. 1

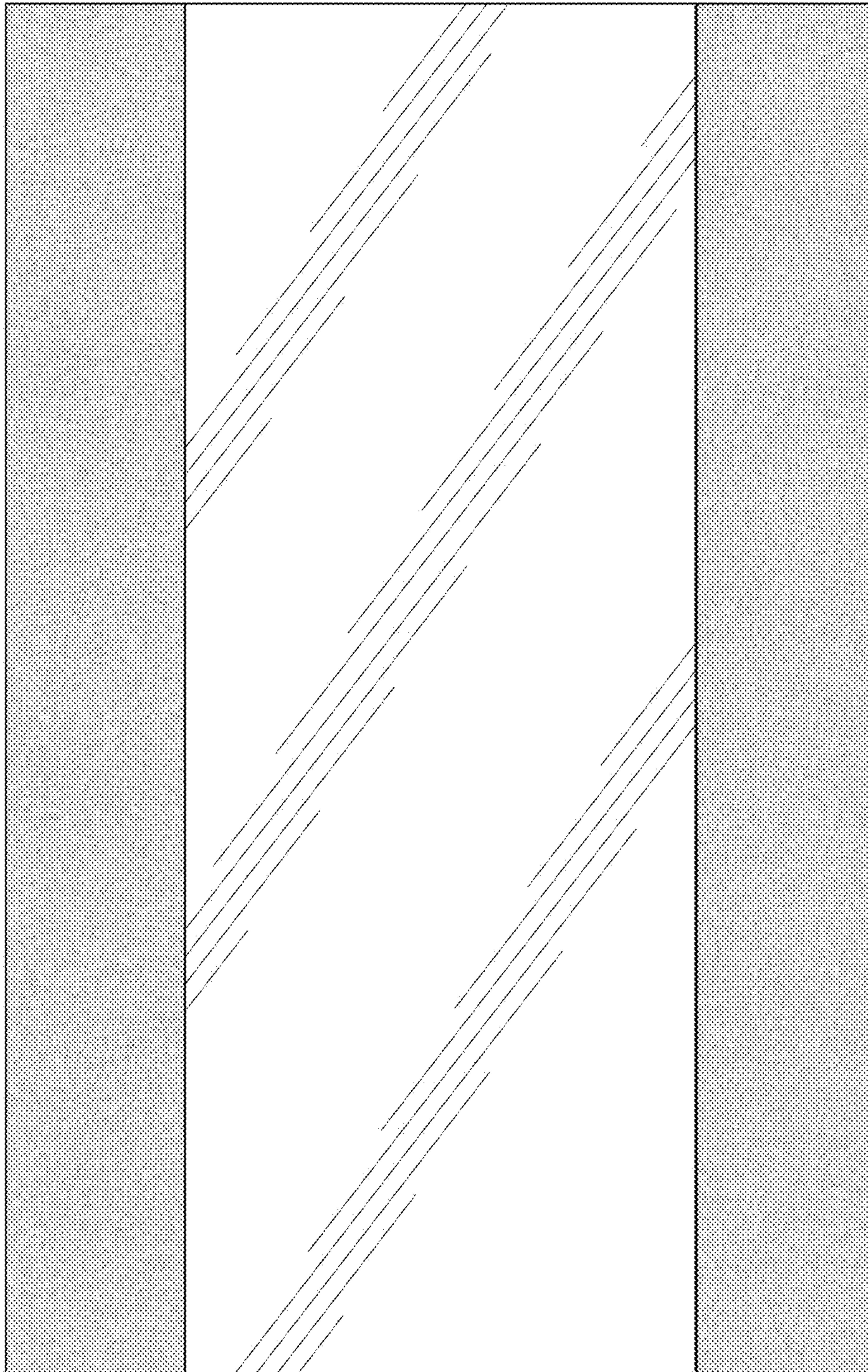

FIG. 2

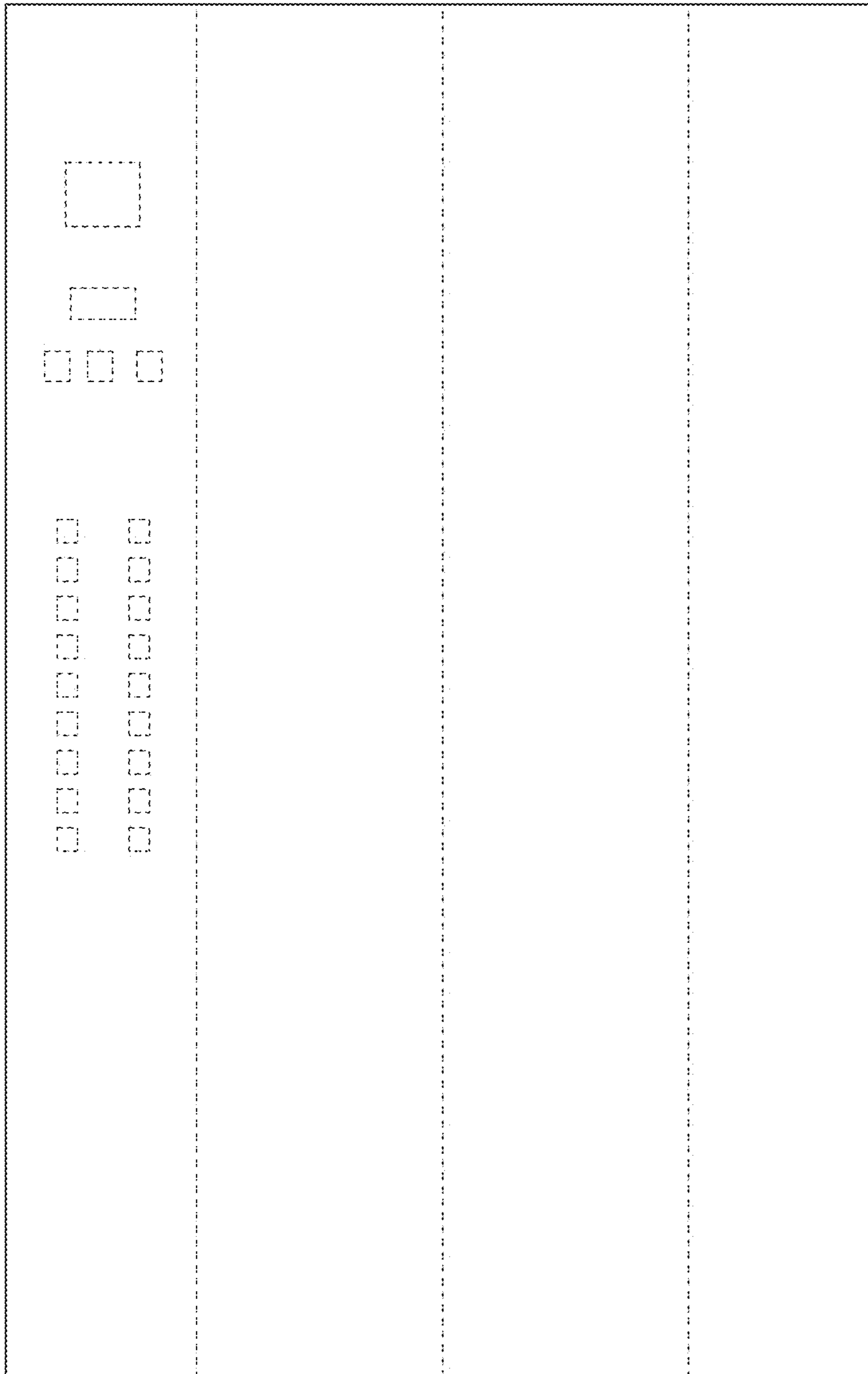

FIG. 3

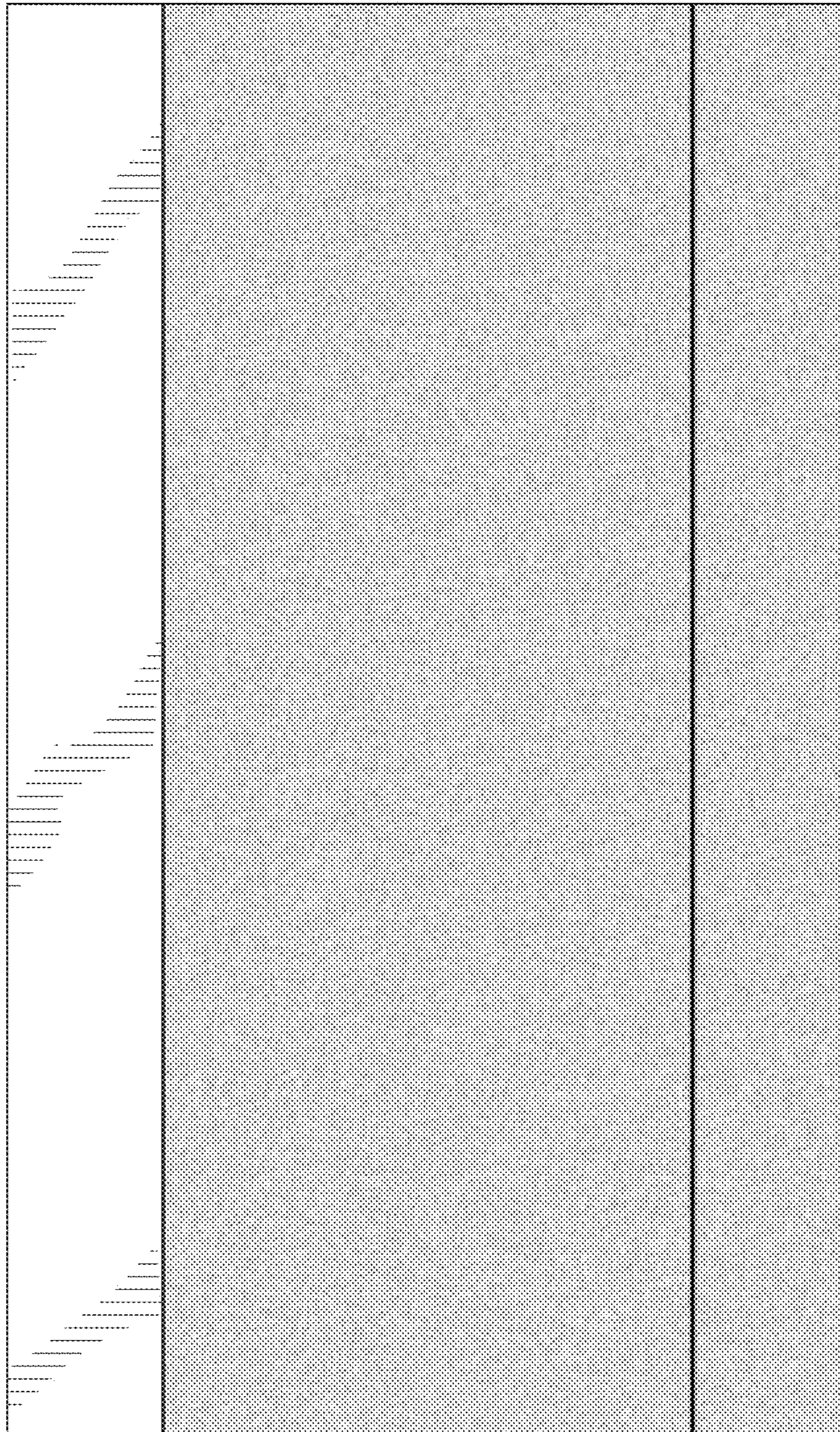

FIG. 4

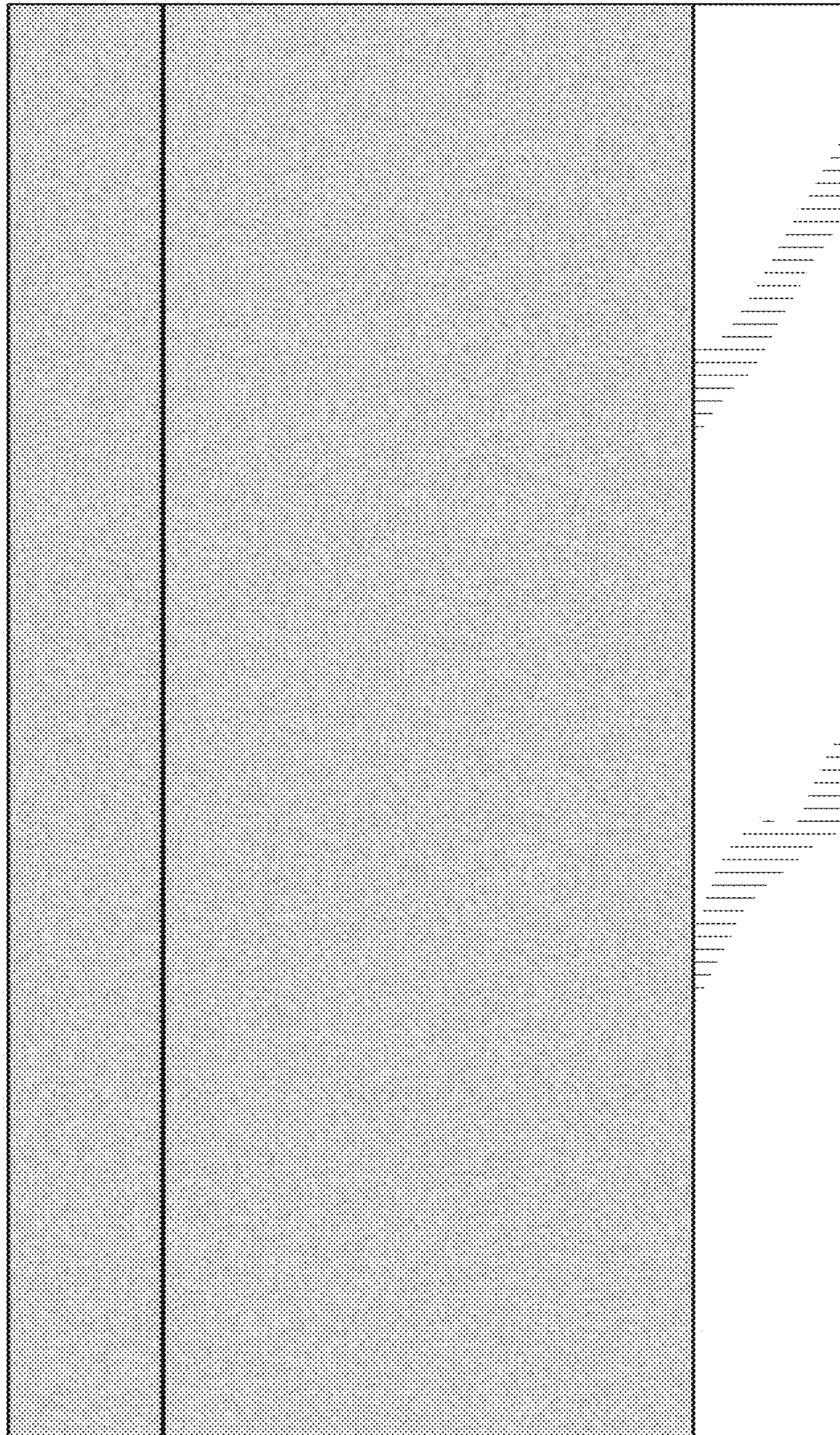

FIG. 5

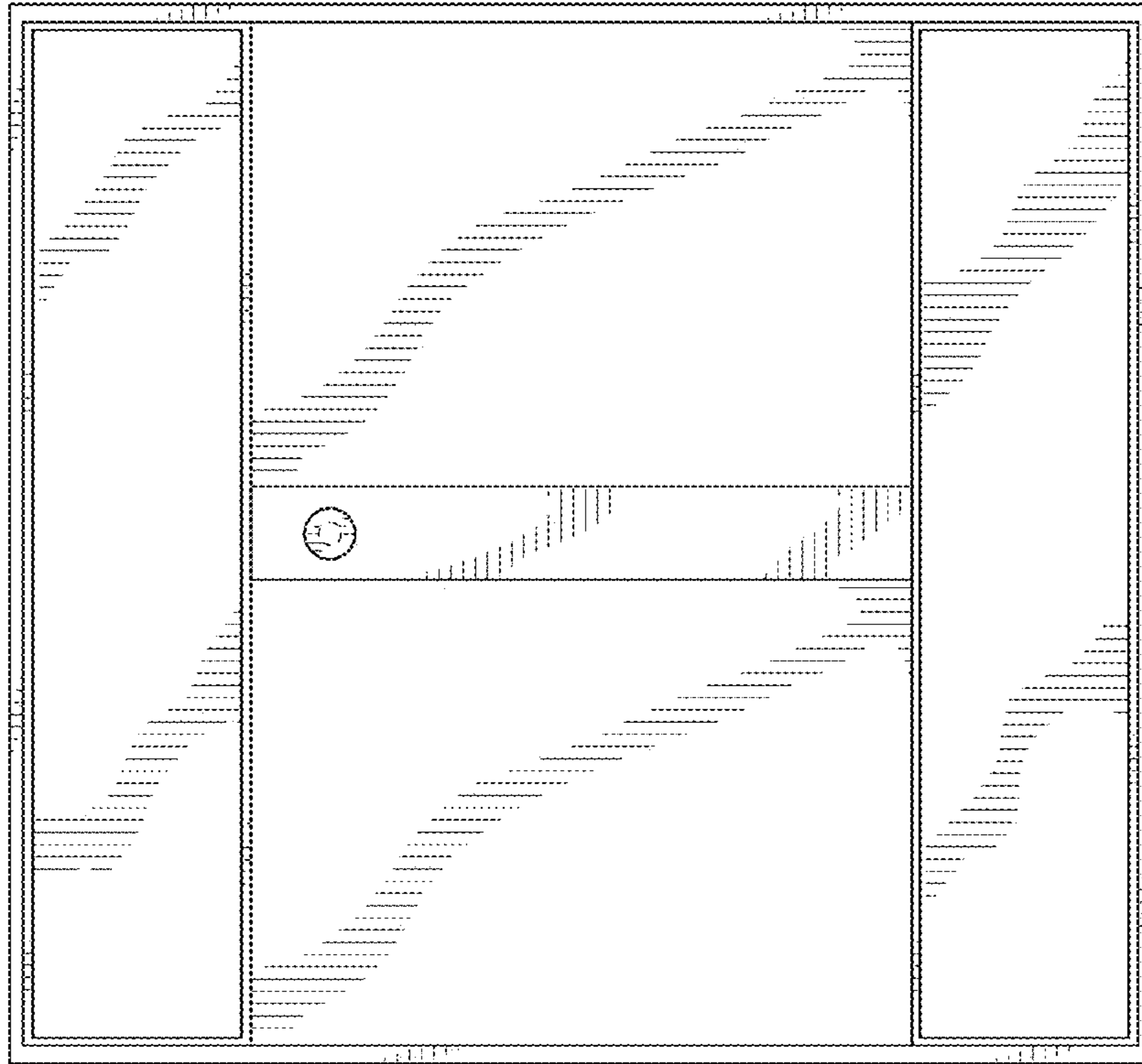

FIG. 6

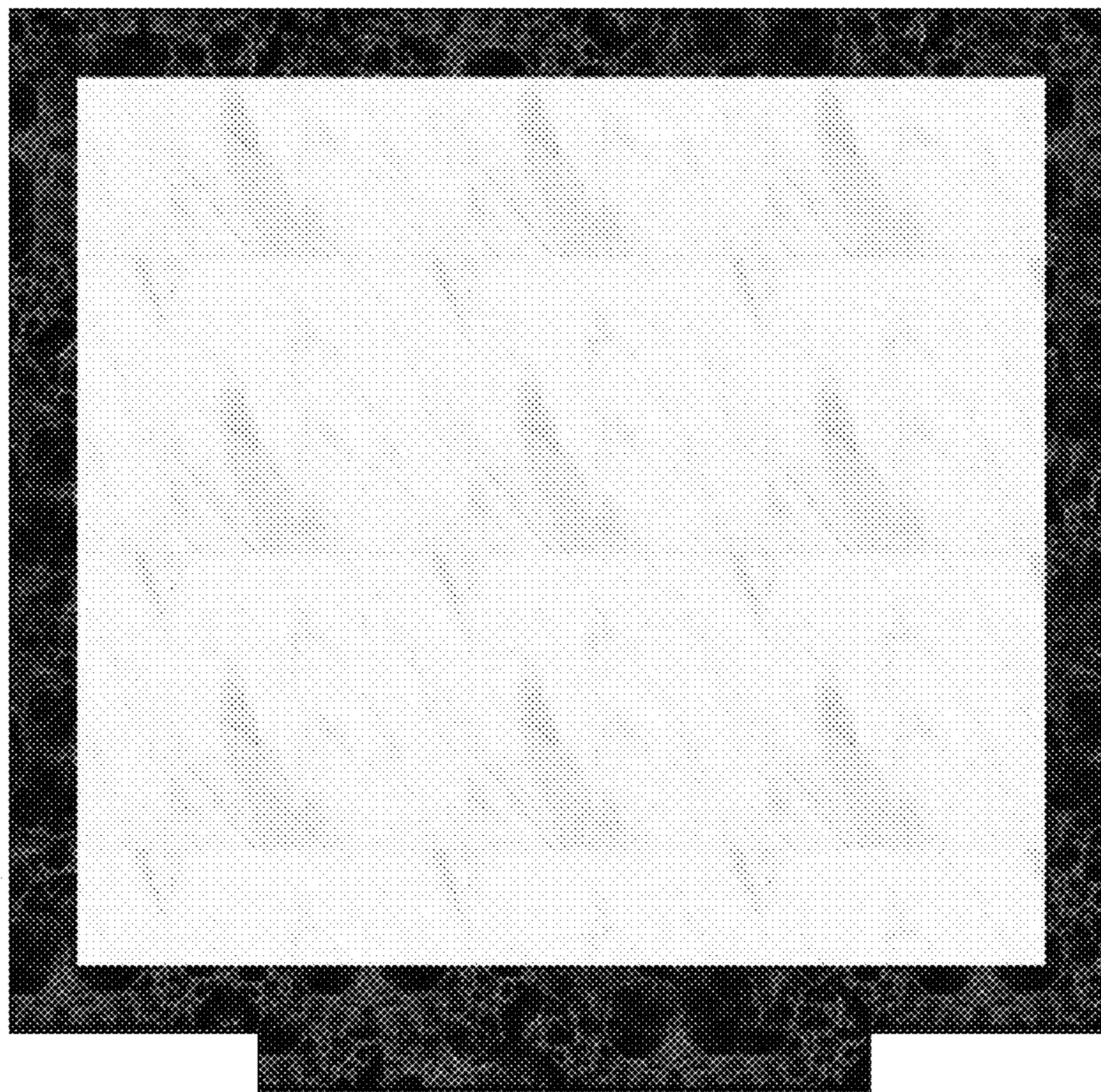

FIG. 7

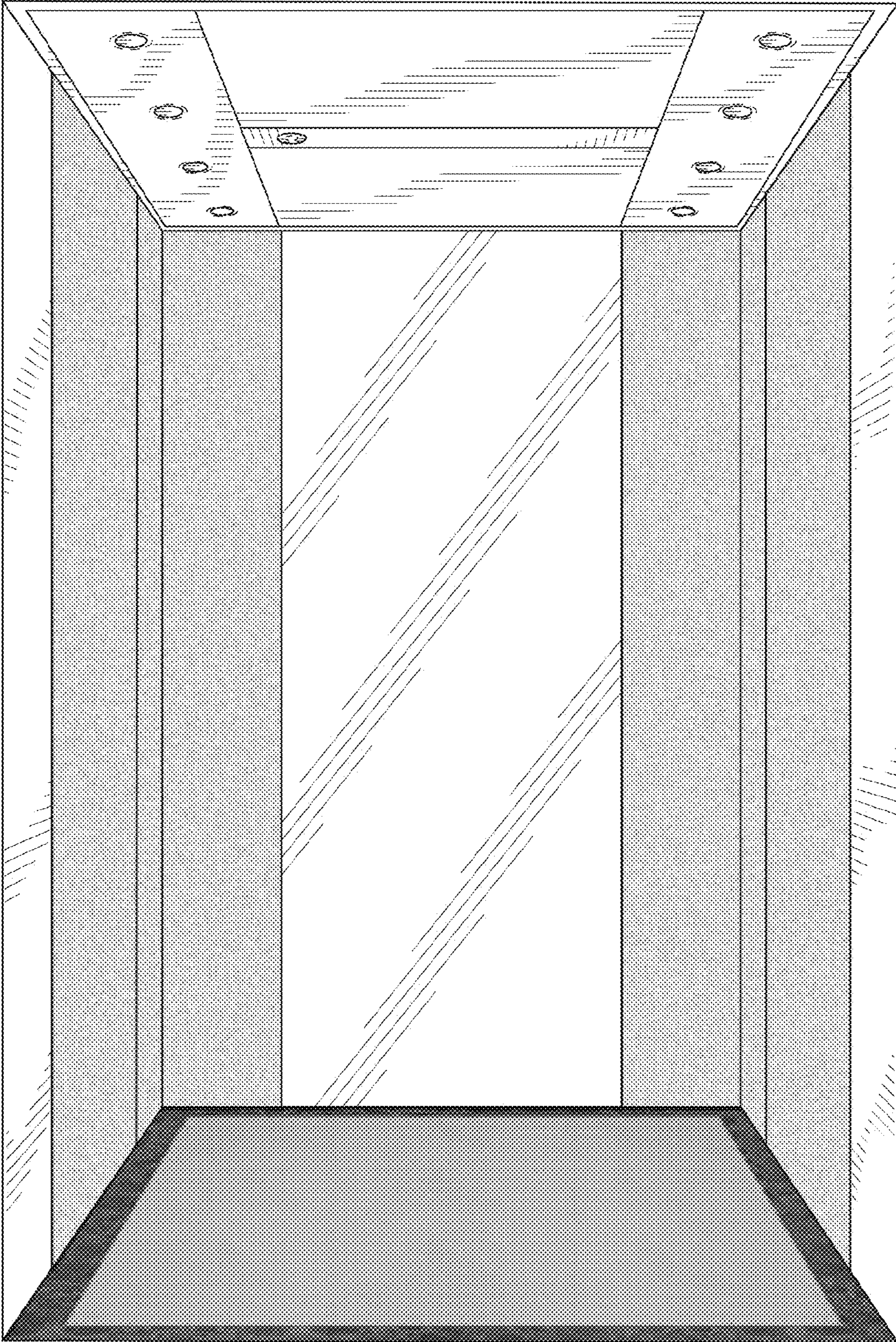

FIG. 8

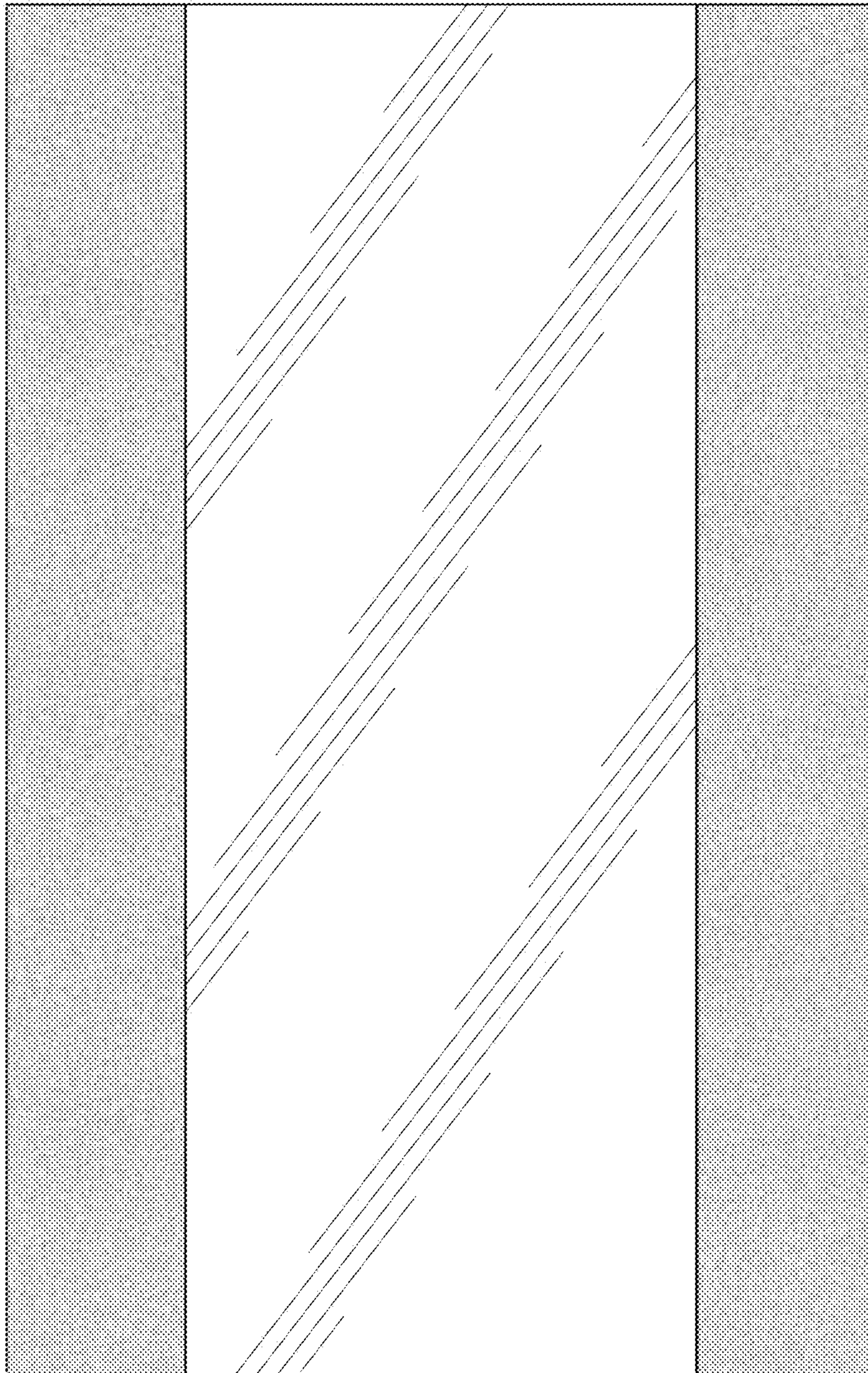

FIG. 9

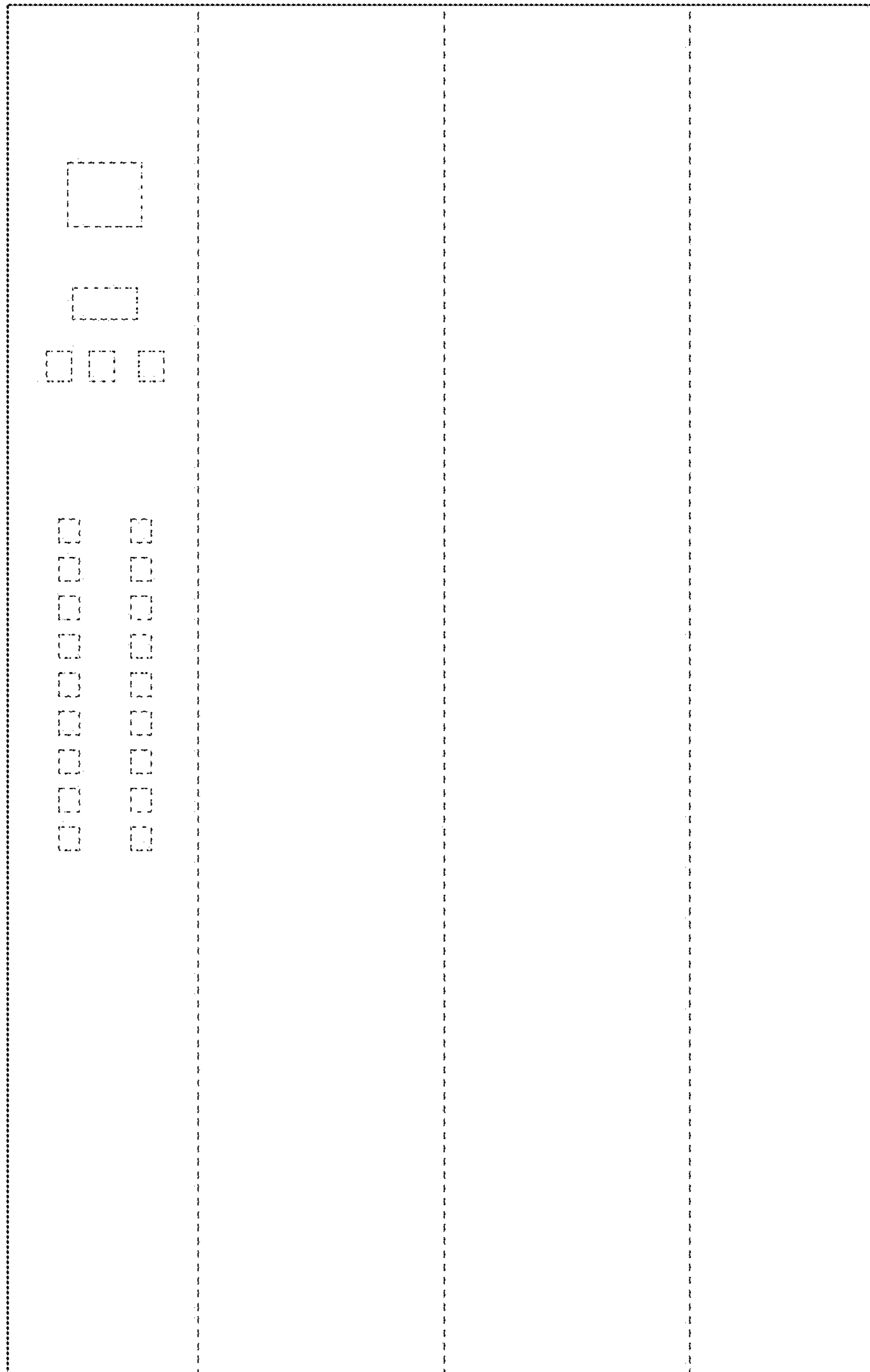

FIG. 10

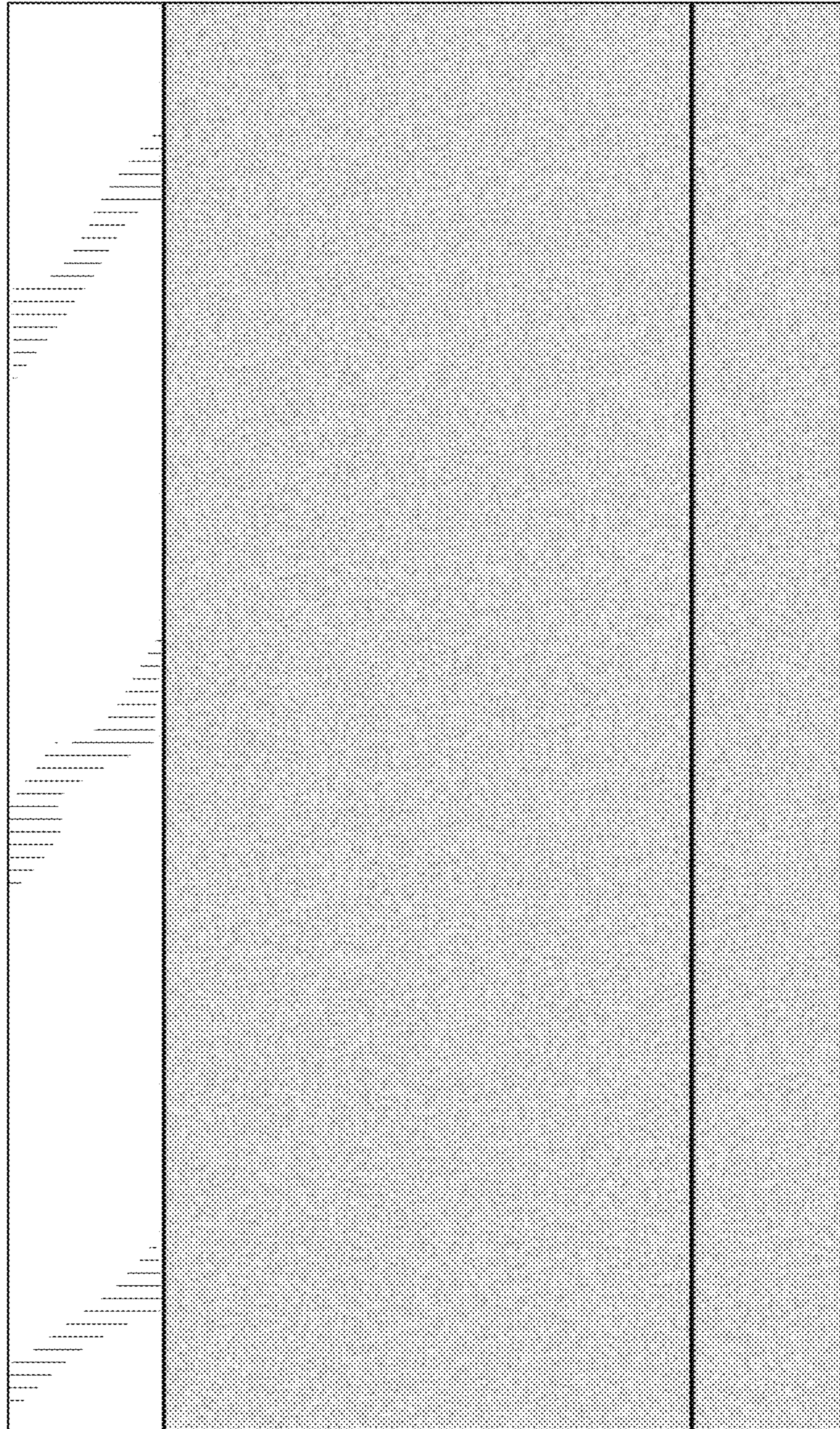

FIG. 11

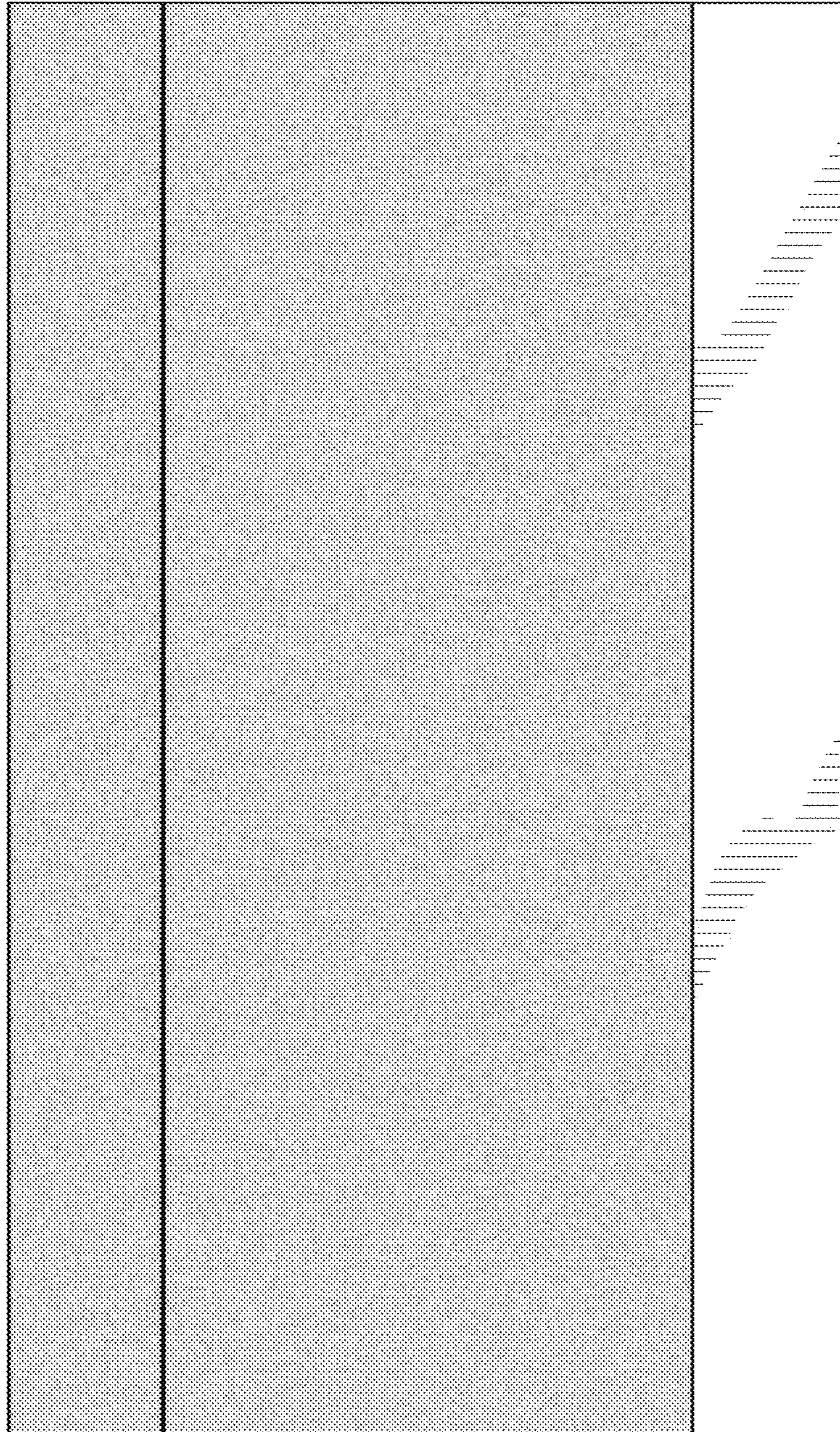

FIG. 12

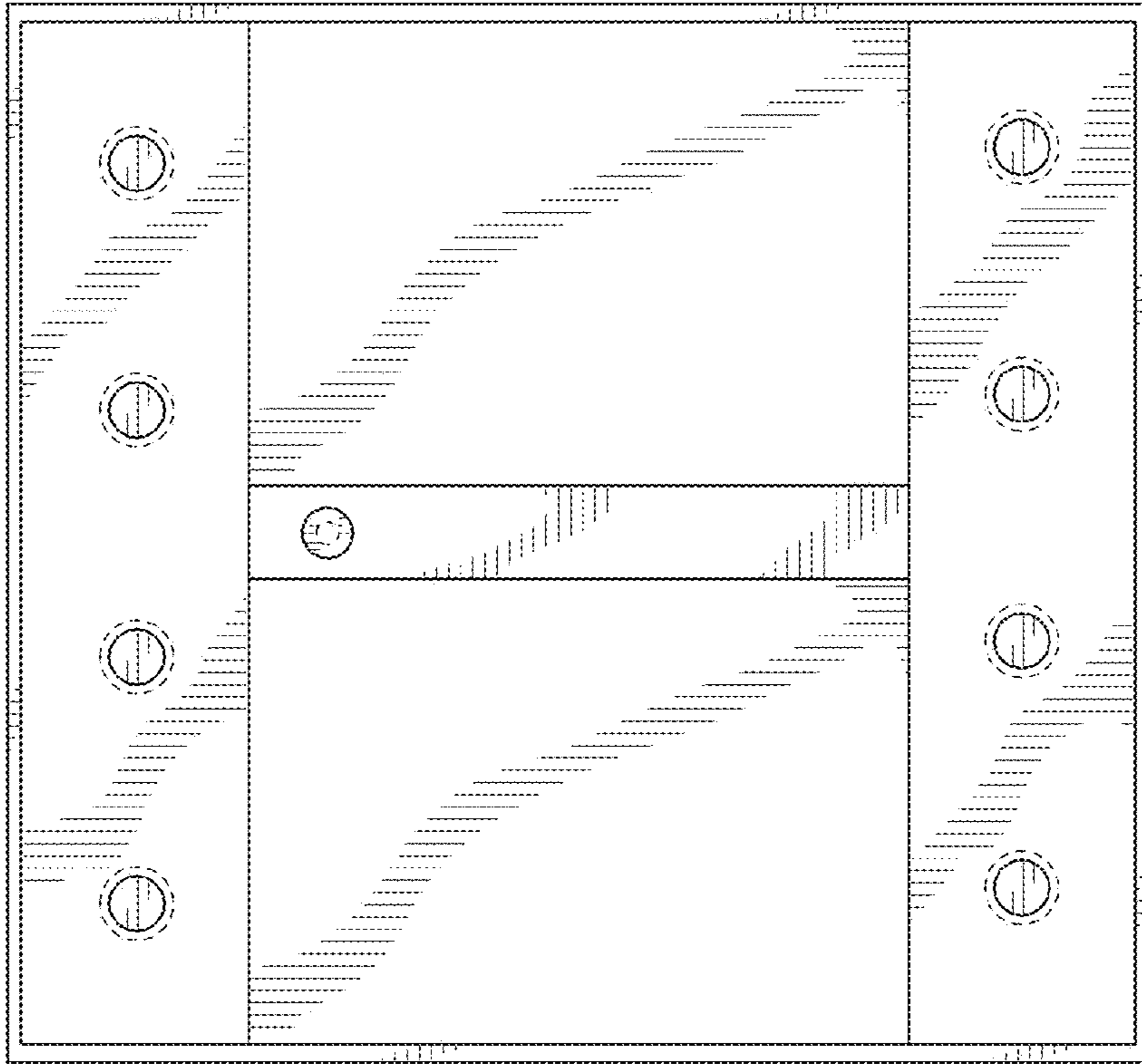

FIG. 13

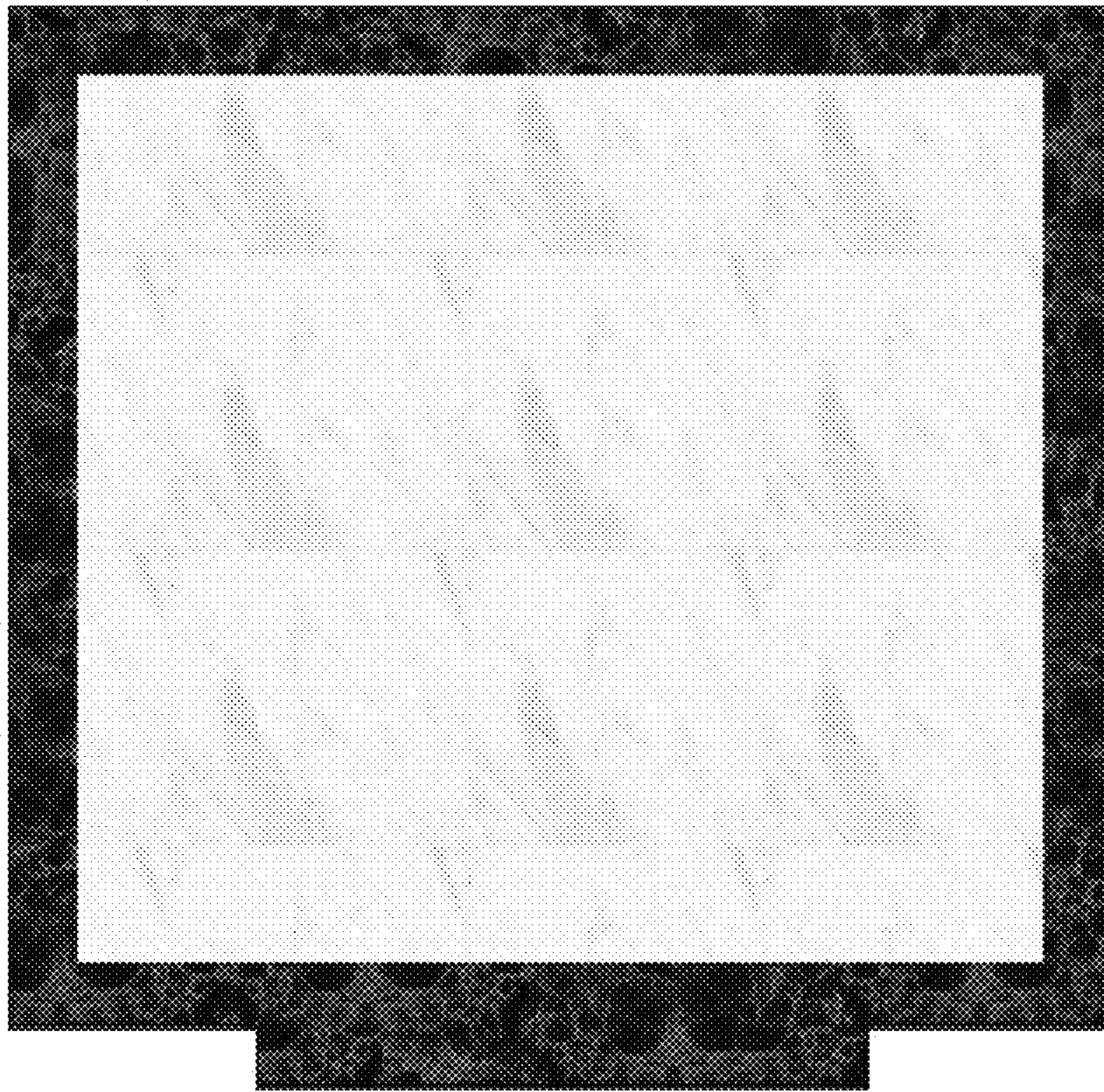

FIG. 14