



US00D846022S

(12) **United States Design Patent**
Kim

(10) **Patent No.:** **US D846,022 S**
(45) **Date of Patent:** **** Apr. 16, 2019**

(54) **ATTACHMENT FOR PRINTER**

(71) Applicant: **S-Printing Solution Co., Ltd.**,
Suwon-si (KR)
(72) Inventor: **Kyong-Hwan Kim**, Seoul (KR)
(73) Assignee: **HP PRINTING KOREA CO., LTD.**,
Suwon-si (KR)
(**) Term: **15 Years**

(21) Appl. No.: **29/604,855**

(22) Filed: **May 22, 2017**

(30) **Foreign Application Priority Data**

Feb. 17, 2017 (KR) 30-2017-0007503

(51) **LOC (11) Cl.** **18-99**

(52) **U.S. Cl.**
USPC **D18/47**

(58) **Field of Classification Search**
USPC D18/36, 37, 38, 39, 46, 47, 48, 49, 50,
D18/53
CPC B41J 3/00; B41J 3/28; B41J 3/445; B41J
3/46; G06K 15/12; G06K 15/14; H04N
1/00204; H04N 1/00249; H04N 1/00278;
G03G 15/6538; B65H 2408/118; G06M
7/06; G06M 7/08; G06M 7/10; G06M
9/00; G06M 9/02; G06M 9/025

See application file for complete search history.

(56) **References Cited**

U.S. PATENT DOCUMENTS

D403,349 S * 12/1998 Hirose D18/46
D404,420 S * 1/1999 Takada D18/47
D421,044 S * 2/2000 Komatsu D18/47
D423,041 S * 4/2000 Takeuchi D18/46
D438,239 S * 2/2001 Agata D18/47
6,226,471 B1 * 5/2001 Tsuzuki G03G 15/50
399/43
D450,753 S * 11/2001 Nomura D18/47

(Continued)

OTHER PUBLICATIONS

Canon USA. <URL: <https://www.usa.canon.com/internet/portal/us/home/products/details/copiers-mfps-fax-machines/multifunction-copiers/imagerunner-advance-6565i>> Visited Jul. 9, 2018. Multi-function Copier imageRUNNER Advance 6565i.*

Primary Examiner — Thomas Johannes

Assistant Examiner — Lauren D McVey

(74) *Attorney, Agent, or Firm* — NSIP Law

(57) **CLAIM**

I claim the ornamental design for an attachment for printer, as shown and described.

DESCRIPTION

FIG. 1 is a front perspective view of an attachment for printer showing my new design; FIG. 2 is a front elevational view thereof; FIG. 3 is a rear elevational view thereof; FIG. 4 is a left-side elevational view thereof; FIG. 5 is a right-side elevational view thereof; FIG. 6 is a top plan view thereof; FIG. 7 is a bottom plan view thereof; FIG. 8 is a cross-sectional view taken in the direction of line 8-8 of FIG. 2; and, FIG. 9 is a front perspective view of the attachment for printer with environment in order to show aspects of the design not otherwise apparent.

The evenly-spaced broken lines immediately adjacent to the shaded areas represent the bounds of the claimed design, and form no part of the claimed design, while all other evenly-spaced broken lines are directed to environment and form no part of the claimed design. The dot-dash lines and arrow symbols shown in FIG. 2 identify the plane along which the cross-sectional view shown in FIG. 8 is cut, and they form no part of the claimed design.

1 Claim, 9 Drawing Sheets

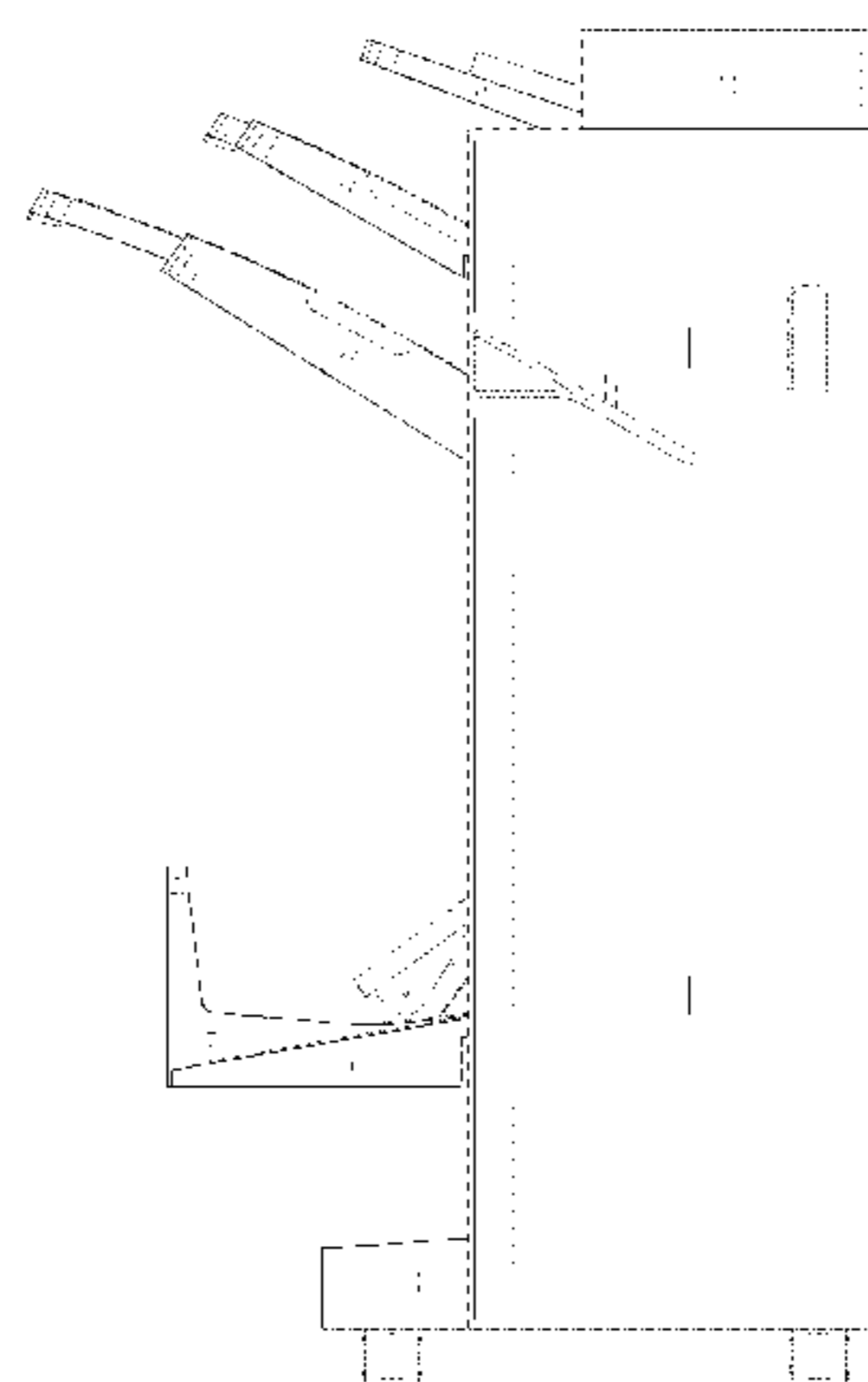
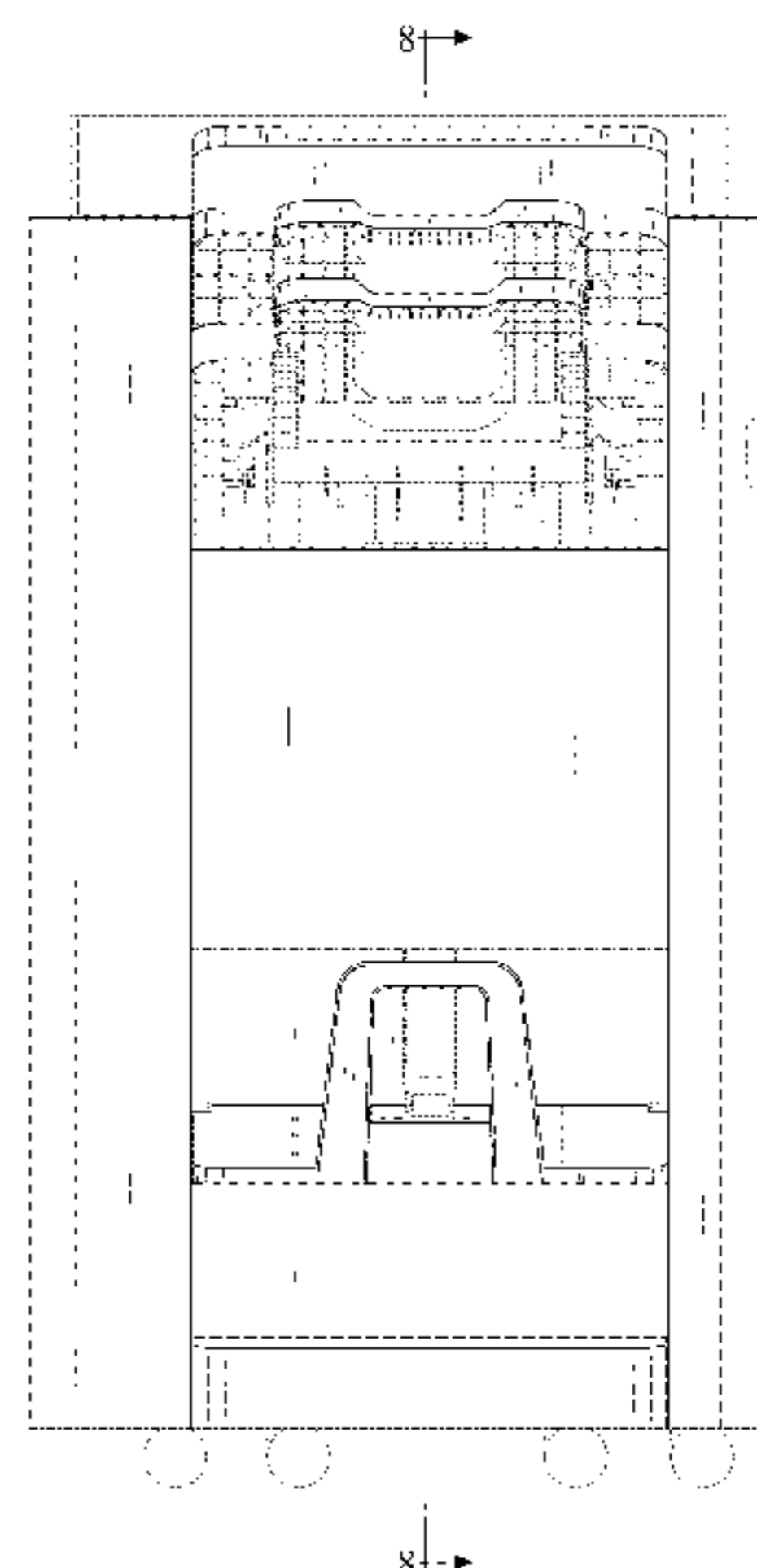

(56)

References Cited

U.S. PATENT DOCUMENTS

| | | | |
|-------------------|---------|----------------|------------------------|
| D451,128 S * | 11/2001 | Ortiz | D18/47 |
| D462,380 S * | 9/2002 | Ortiz | D18/47 |
| D558,259 S * | 12/2007 | Kohno | D18/47 |
| D765,165 S * | 8/2016 | Kim | D18/47 |
| D795,342 S * | 8/2017 | Nagasaki | D18/40 |
| 2007/0212097 A1 * | 9/2007 | Hoshino | G03G 15/5016 399/81 |

* cited by examiner

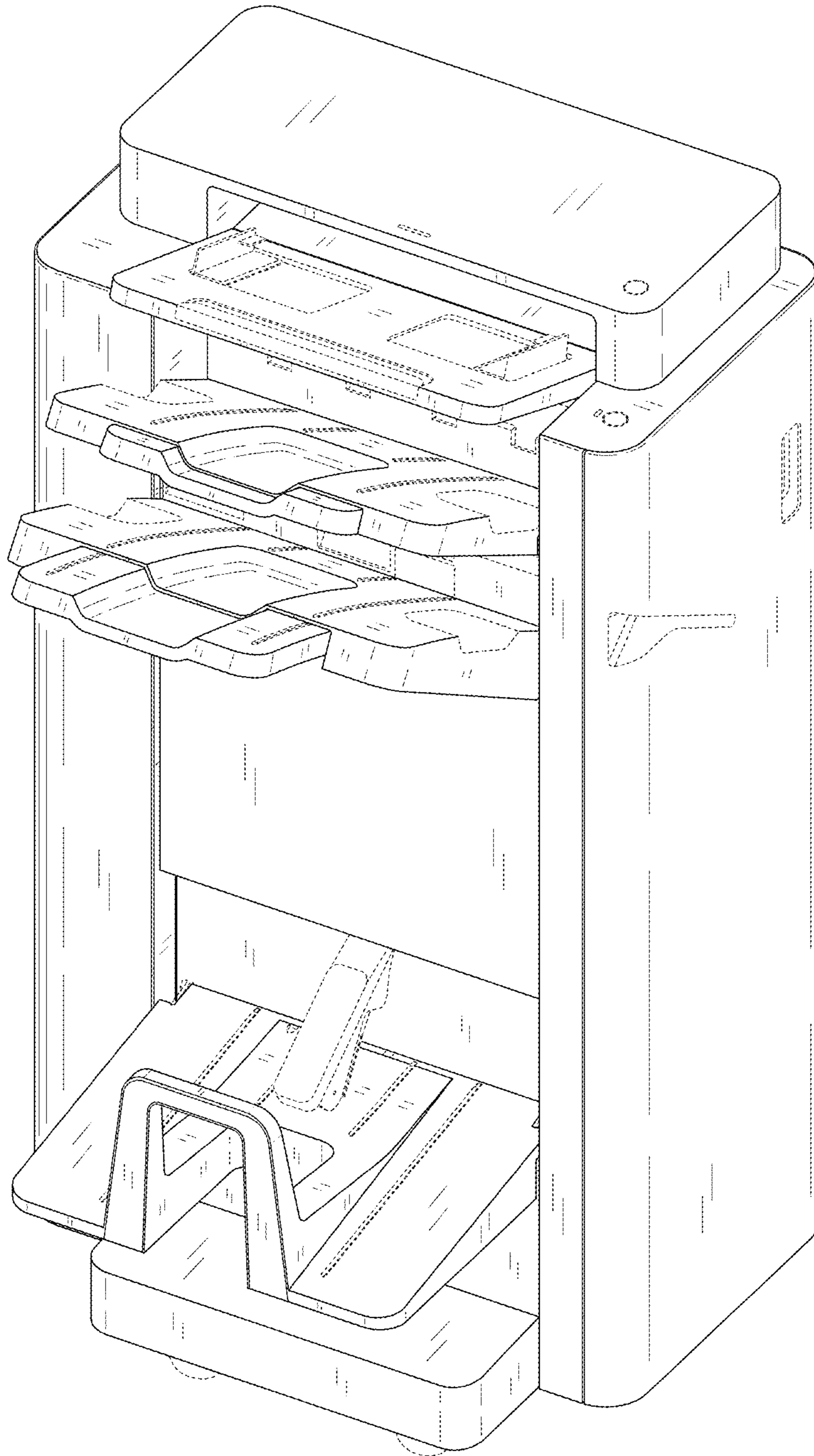

FIG. 1

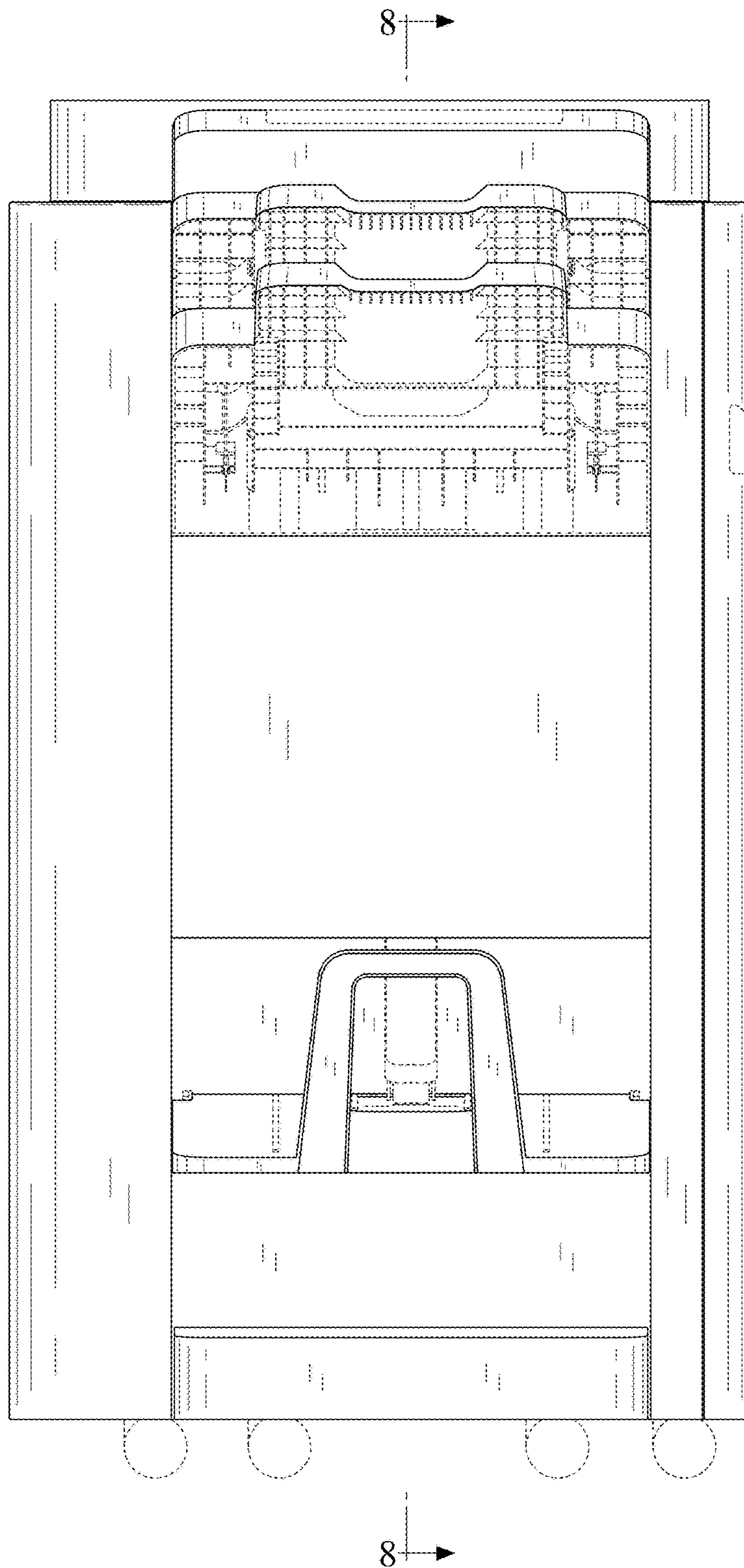

FIG. 2

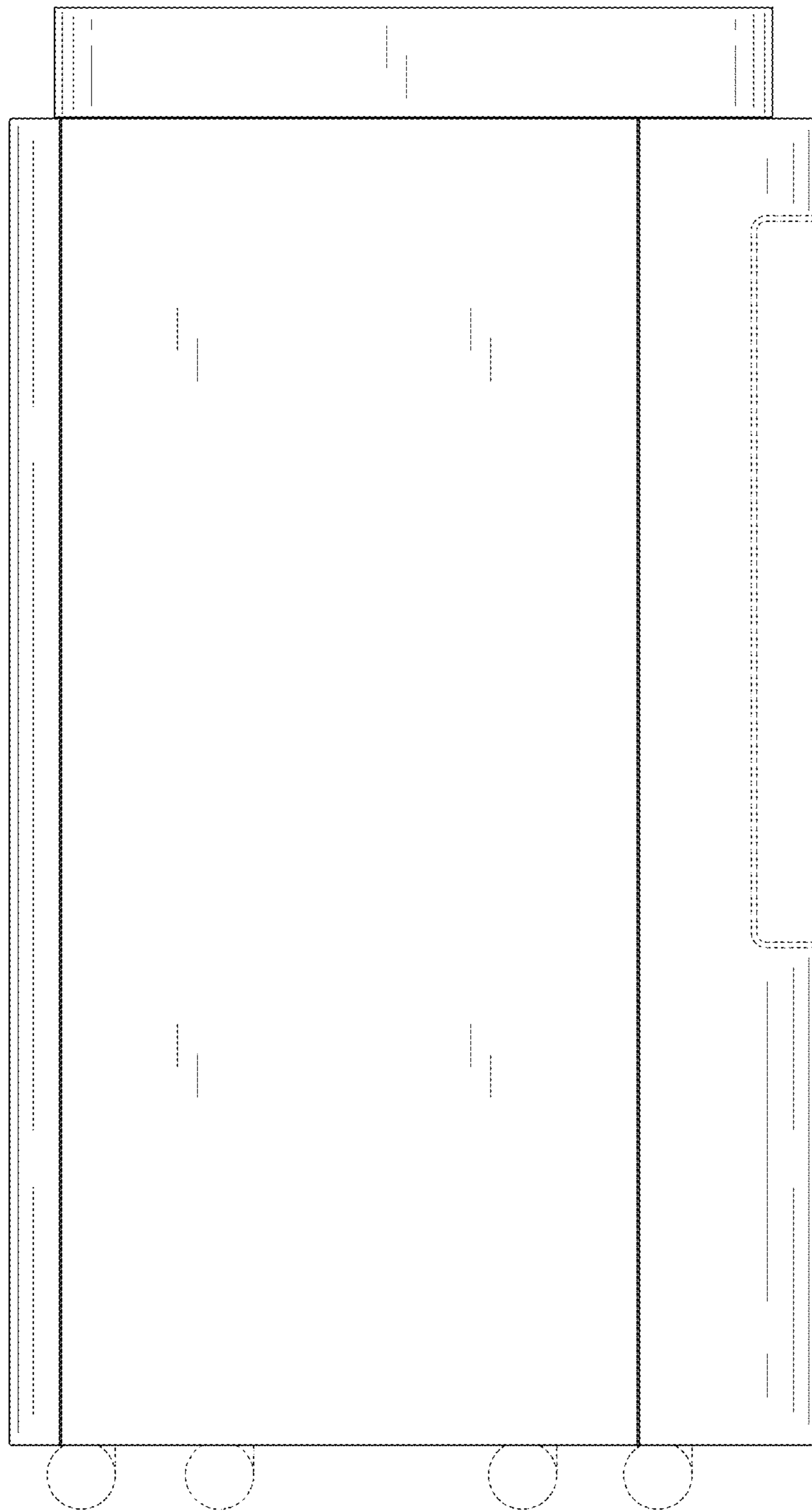

FIG. 3

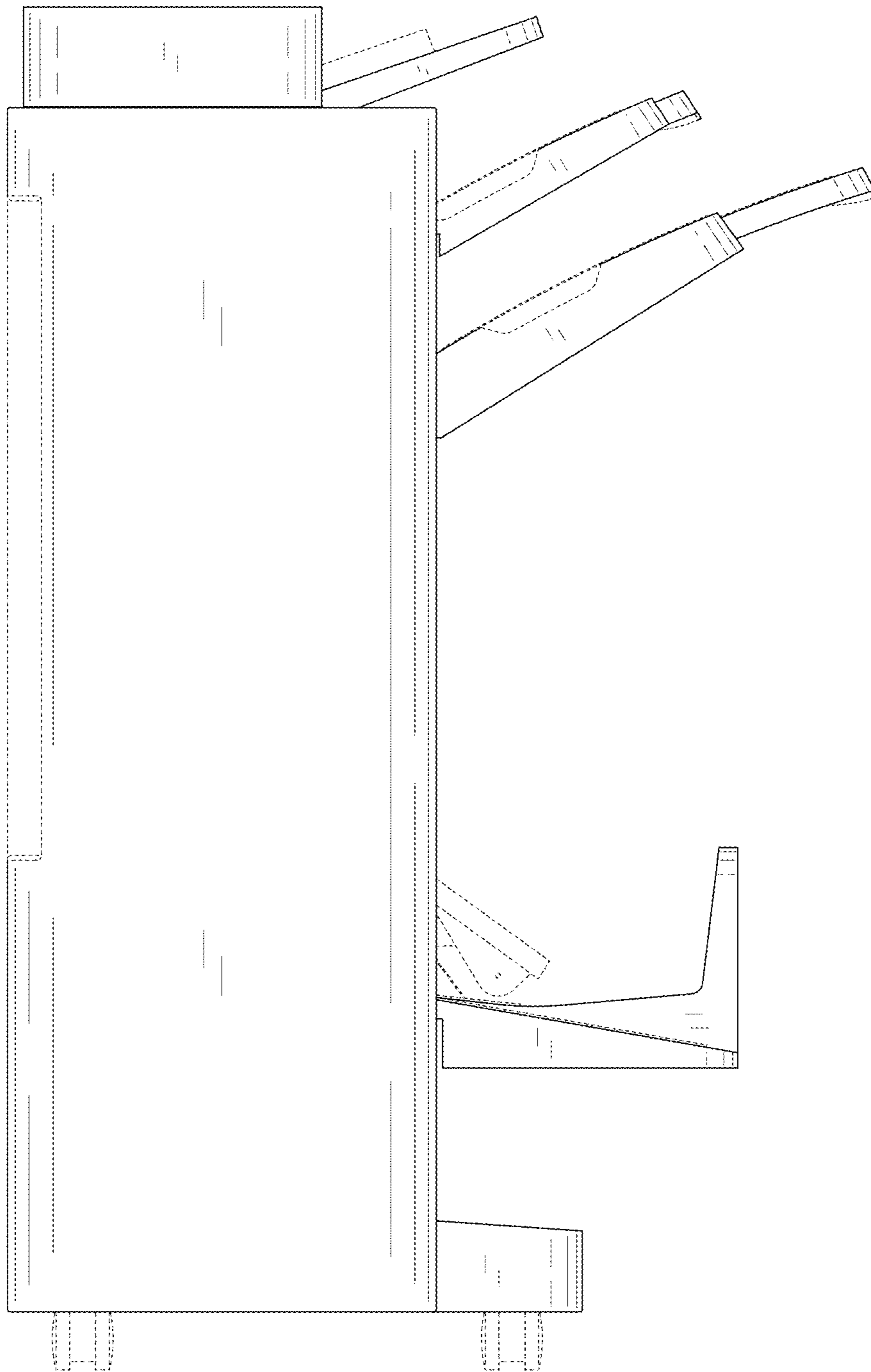

FIG. 4

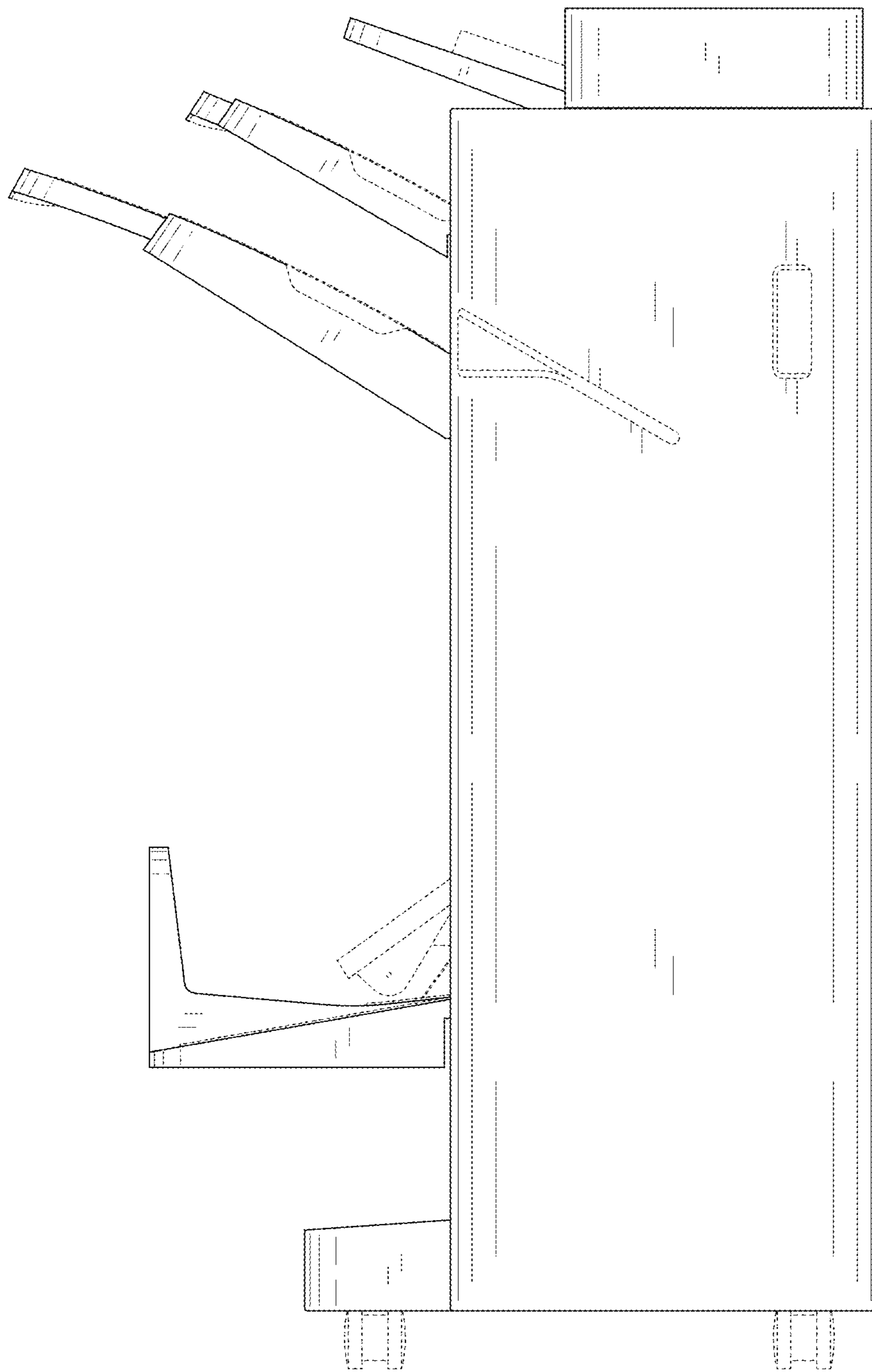

FIG. 5

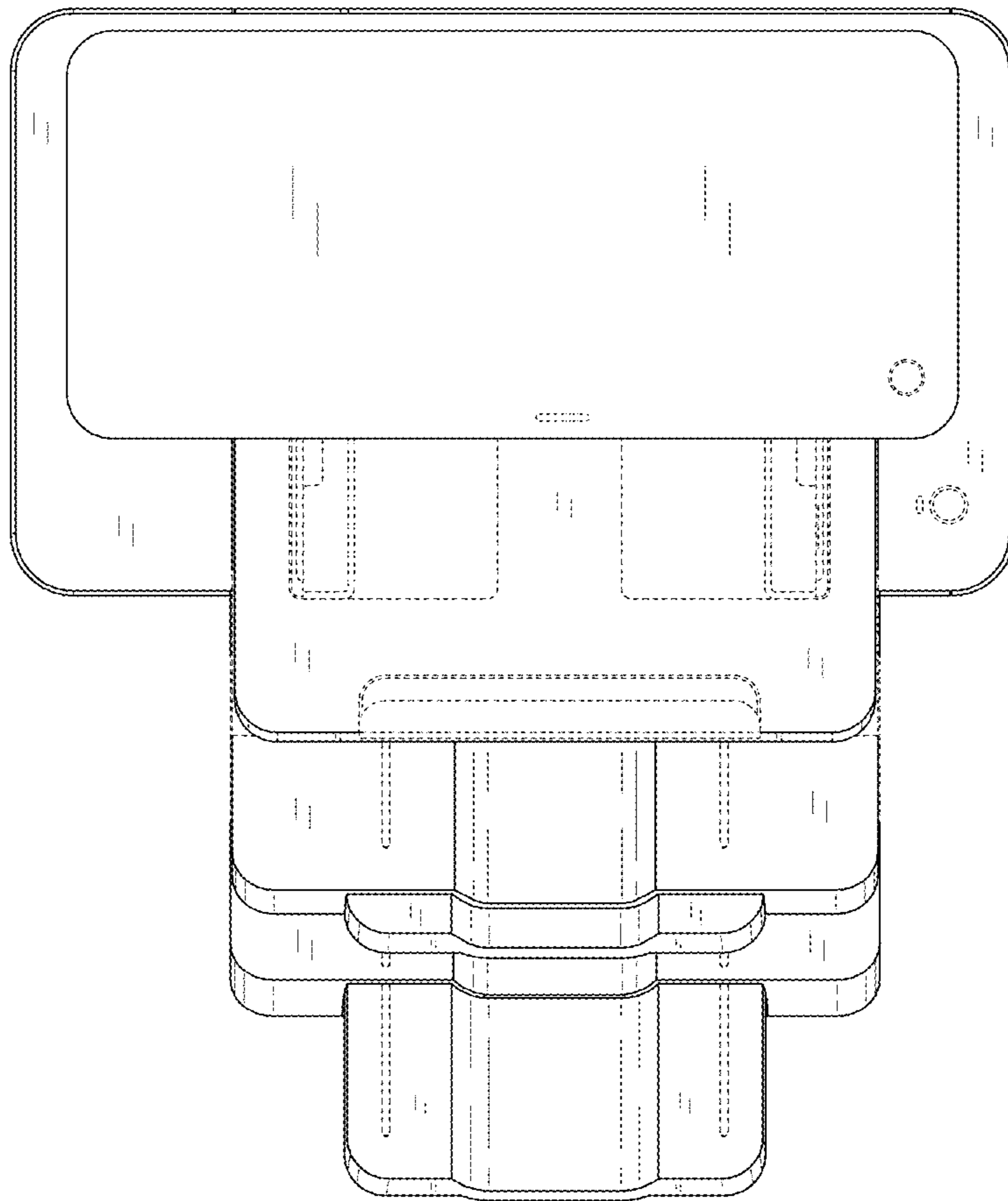

FIG. 6

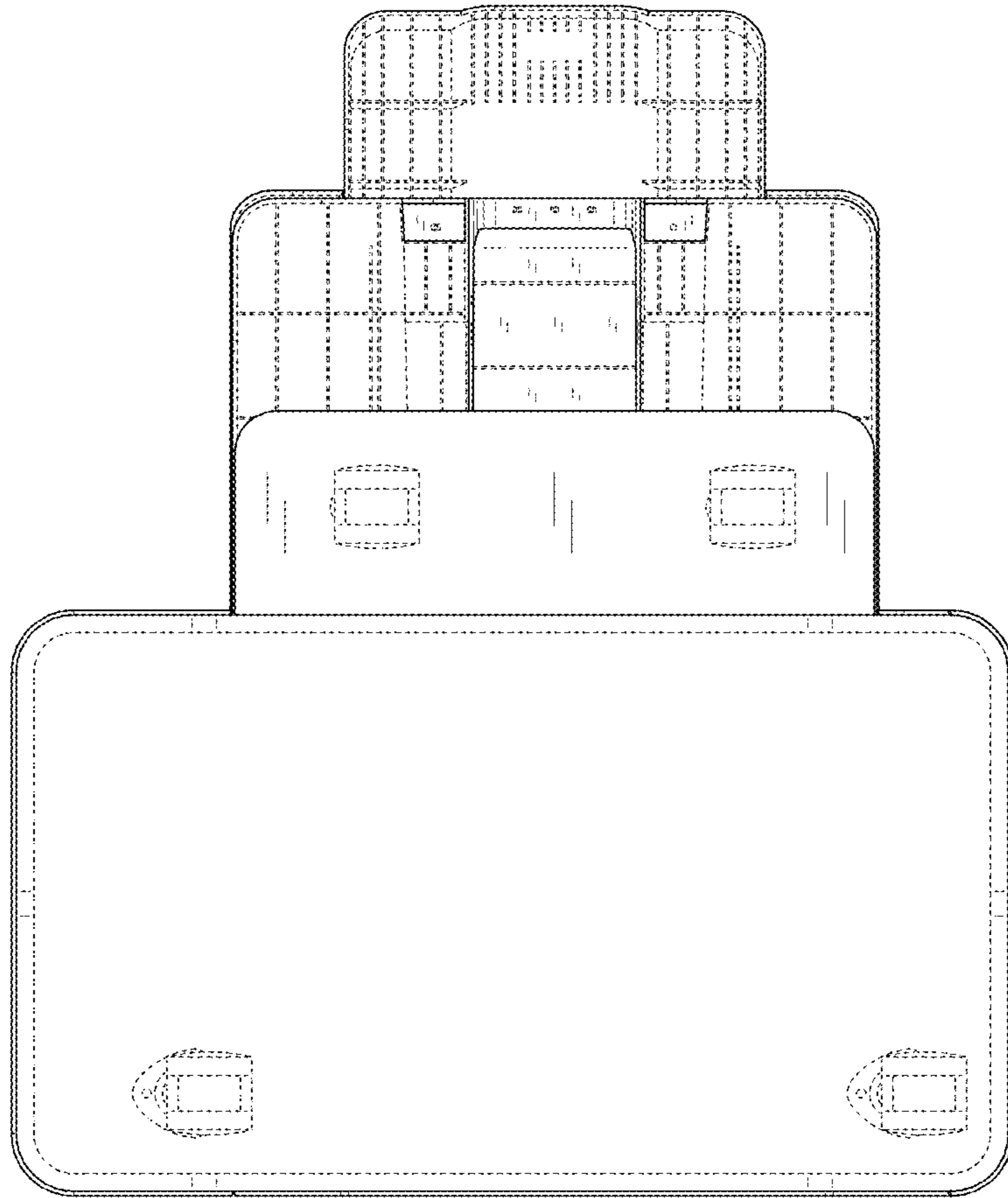

FIG. 7

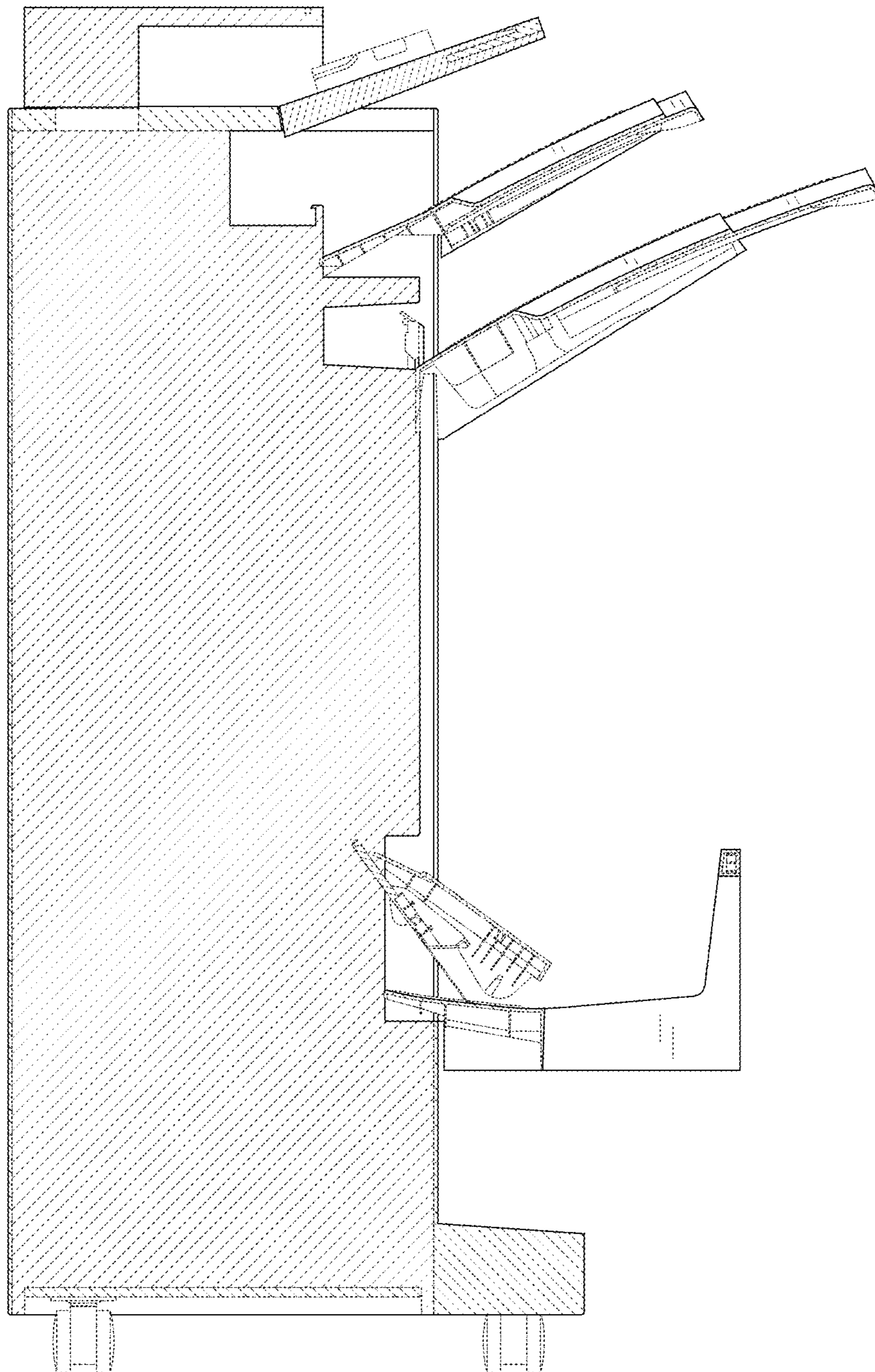

FIG. 8

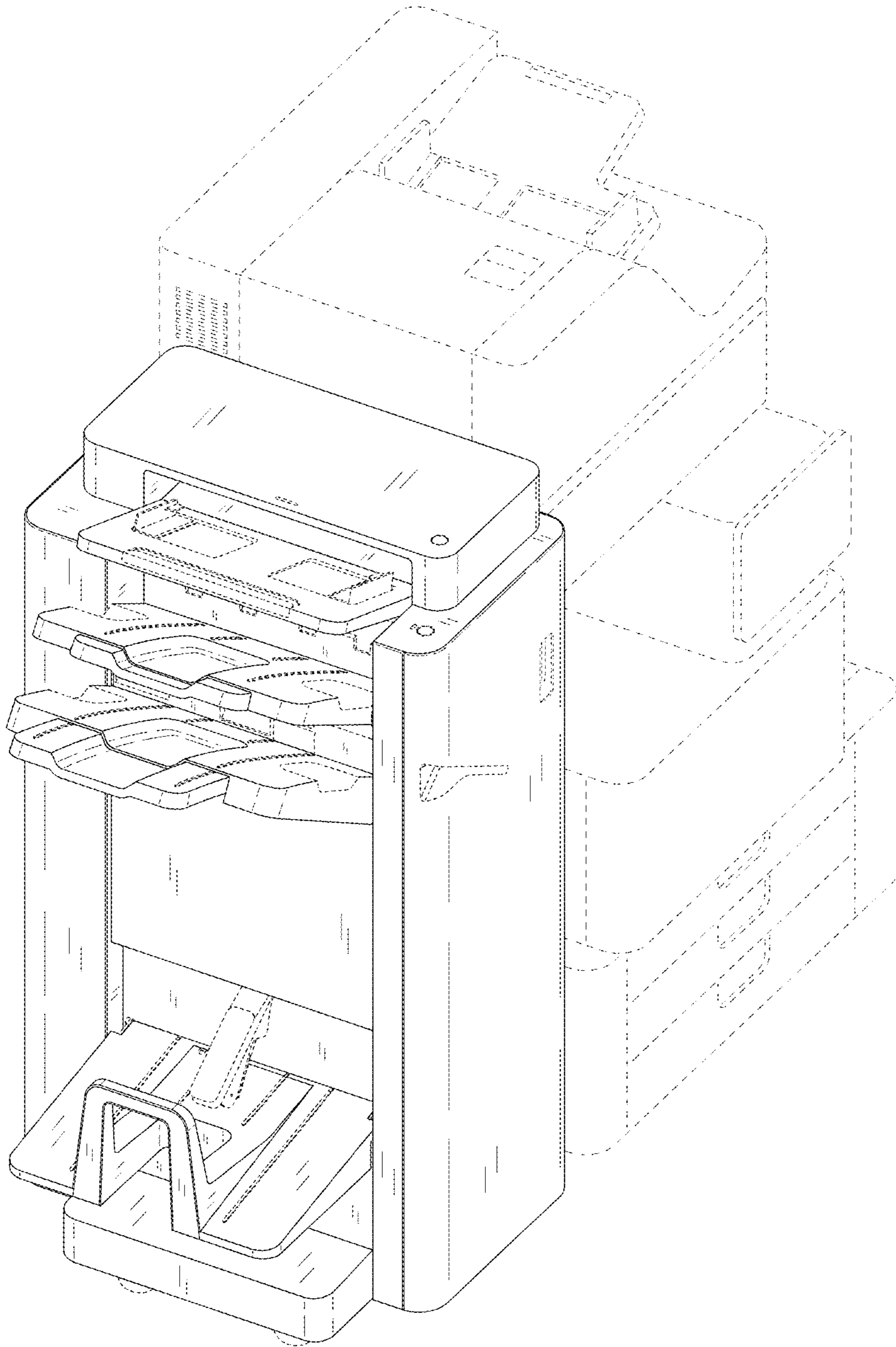

FIG. 9

UNITED STATES PATENT AND TRADEMARK OFFICE
CERTIFICATE OF CORRECTION

PATENT NO. : D846,022 S
APPLICATION NO. : 29/604855
DATED : April 16, 2019
INVENTOR(S) : Kyong-Hwan Kim

Page 1 of 1

It is certified that error appears in the above-identified patent and that said Letters Patent is hereby corrected as shown below:

On the Title Page

Item (71), Applicant, Line 1, delete "S-Printing Solution Co., Ltd.," and insert -- HP PRINTING KOREA CO., LTD., --, therefor.

Signed and Sealed this
Tenth Day of September, 2019

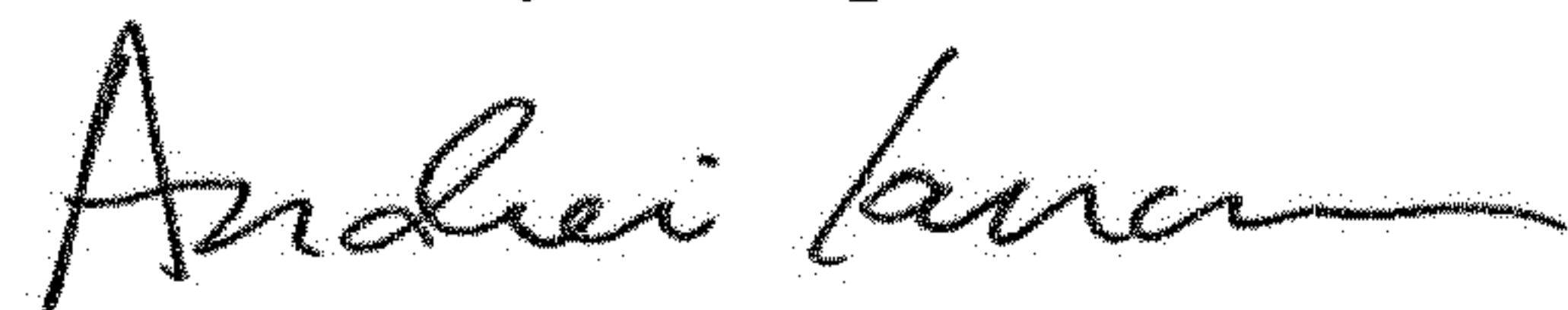

Andrei Iancu
Director of the United States Patent and Trademark Office