

US00D846020S

(12) **United States Design Patent** (10) **Patent No.:** **US D846,020 S**
Mills (45) **Date of Patent:** **** Apr. 16, 2019**

(54) **PICKUP COVER FOR STRING INSTRUMENTS AND ELECTRIC GUITARS**

(71) Applicant: **Chris Mills**, Wayne, PA (US)

(72) Inventor: **Chris Mills**, Wayne, PA (US)

(**) Term: **15 Years**

(21) Appl. No.: **29/605,034**

(22) Filed: **May 23, 2017**

(51) **LOC (11) Cl.** **17-03**

(52) **U.S. Cl.**
USPC **D17/20**

(58) **Field of Classification Search**
USPC D17/4, 9, 13, 14, 15, 16, 17, 18, 19, 20, D17/21, 99; D99/43, 99; D23/252, 303, D23/309, 231, 238; D8/300, 307, 308, D8/321, 322; D11/79, 81, 85, 86; D21/478
CPC G10H 3/181; G10H 3/182; G10H 3/18; G10H 3/00; G10D 1/085; G10D 3/14; G10D 3/04; G10D 3/12
See application file for complete search history.

(56) **References Cited**

U.S. PATENT DOCUMENTS

- 3,544,696 A * 12/1970 Broussard G10D 1/085 84/726
- D317,646 S * 6/1991 Yost D23/252
- D440,315 S * 4/2001 Hassenbein D24/189
- D519,239 S * 4/2006 Katagiri D24/189
- D549,094 S * 8/2007 Oner D9/418
- D614,075 S * 4/2010 Kothari D11/79
- D632,993 S * 2/2011 Hackett D11/81
- D668,504 S * 10/2012 Lane D7/300.1

(Continued)

OTHER PUBLICATIONS

Guitarpang, History's weirdest-looking guitar pickups, posted Jul. 24, 2015, [online], [site visited Oct. 17, 2018]. Available from Internet, <URL: <https://guitarpang.wordpress.com/2015/07/24/historys-weirdest-looking-guitar-pickups/>> (Year: 2015).*

(Continued)

Primary Examiner — Sheryl Lane

Assistant Examiner — Samantha N Wood

(74) *Attorney, Agent, or Firm* — Saul Ewing Arnstein & Lehr LLP; Gianna Julian Arnold; Brian R. Landry

(57) **CLAIM**

The ornamental design for a pickup cover for string instruments and electric guitars, as shown and described.

DESCRIPTION

FIG. 1 is a perspective view of the front, right, and bottom side of a pickup cover for string instruments showing an embodiment of the new design.

FIG. 2 is a front view thereof.

FIG. 3 is a back view thereof.

FIG. 4 is a right view thereof.

FIG. 5 is a left view thereof.

FIG. 6 is a top view thereof.

FIG. 7 is a bottom view thereof.

FIG. 8 is a perspective view of the front, right, and top side of a pickup cover for string instruments showing another embodiment of the new design.

FIG. 9 is a front view thereof.

FIG. 10 is a back view thereof.

FIG. 11 is a left view thereof.

FIG. 12 is a right view thereof.

FIG. 13 is a top view thereof; and,

FIG. 14 is a bottom view thereof.

The broken lines depict portions of the pickup covers for string instruments and electric guitars in which the design is embodied that are not considered part of the claimed design.

1 Claim, 8 Drawing Sheets

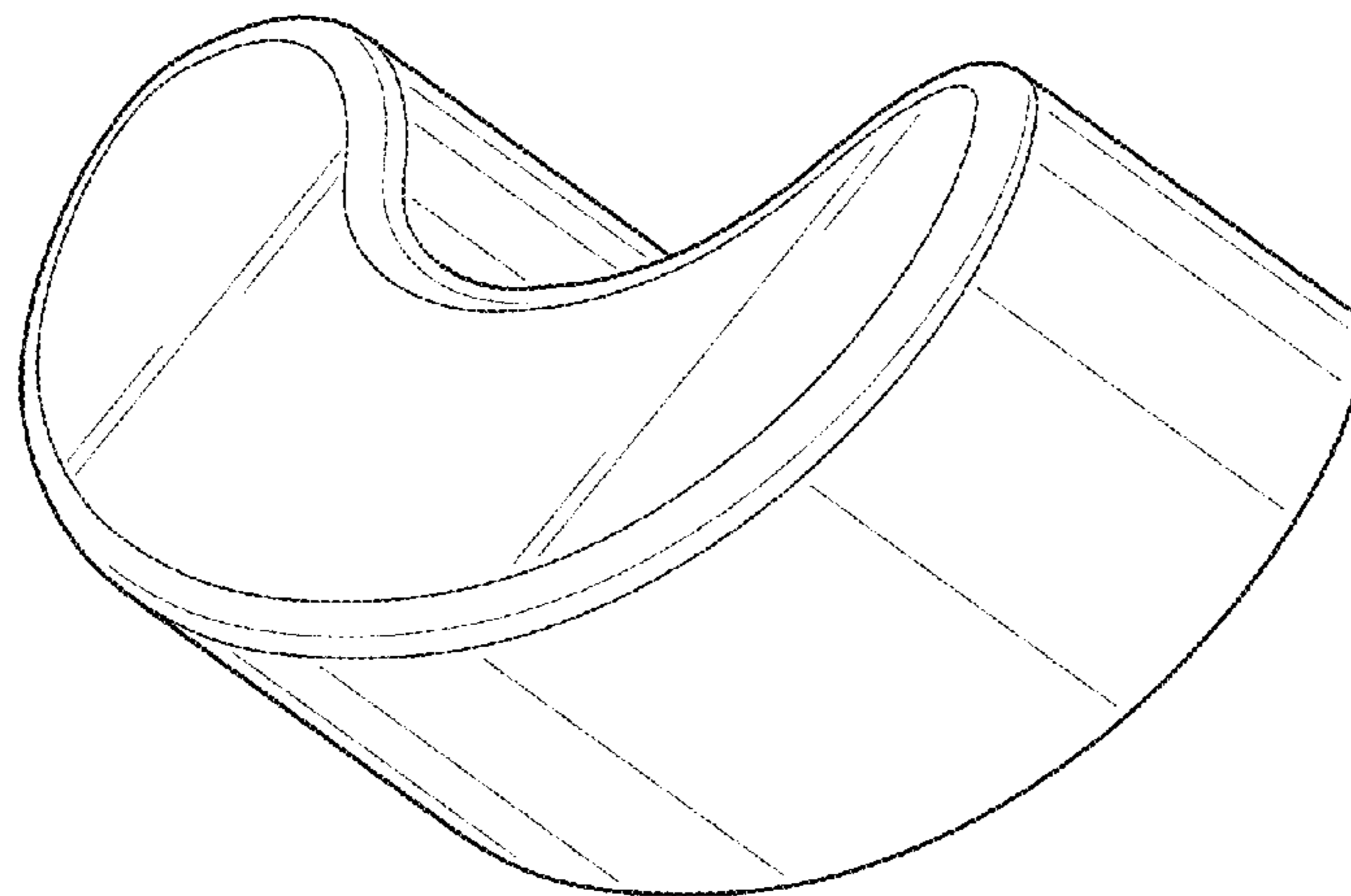

(56)

References Cited

U.S. PATENT DOCUMENTS

D716,866 S * 11/2014 Chappo D17/20

OTHER PUBLICATIONS

Amazon, Yin Yang Keepsake Puzzle box, posted Mar. 29, 2012, [online], [site visited Oct. 17, 2018]. Available from Internet, <URL: https://www.amazon.co.uk/Yang-Keepsake-Puzzle-Maple-Bubinga/dp/B007PSPRBC/ref=sr_1_4?ie=UTF8&qid=1539805990&sr=8-4&keywords=Yin+Yang+Puzzle+Box> (Year: 2012).*

* cited by examiner

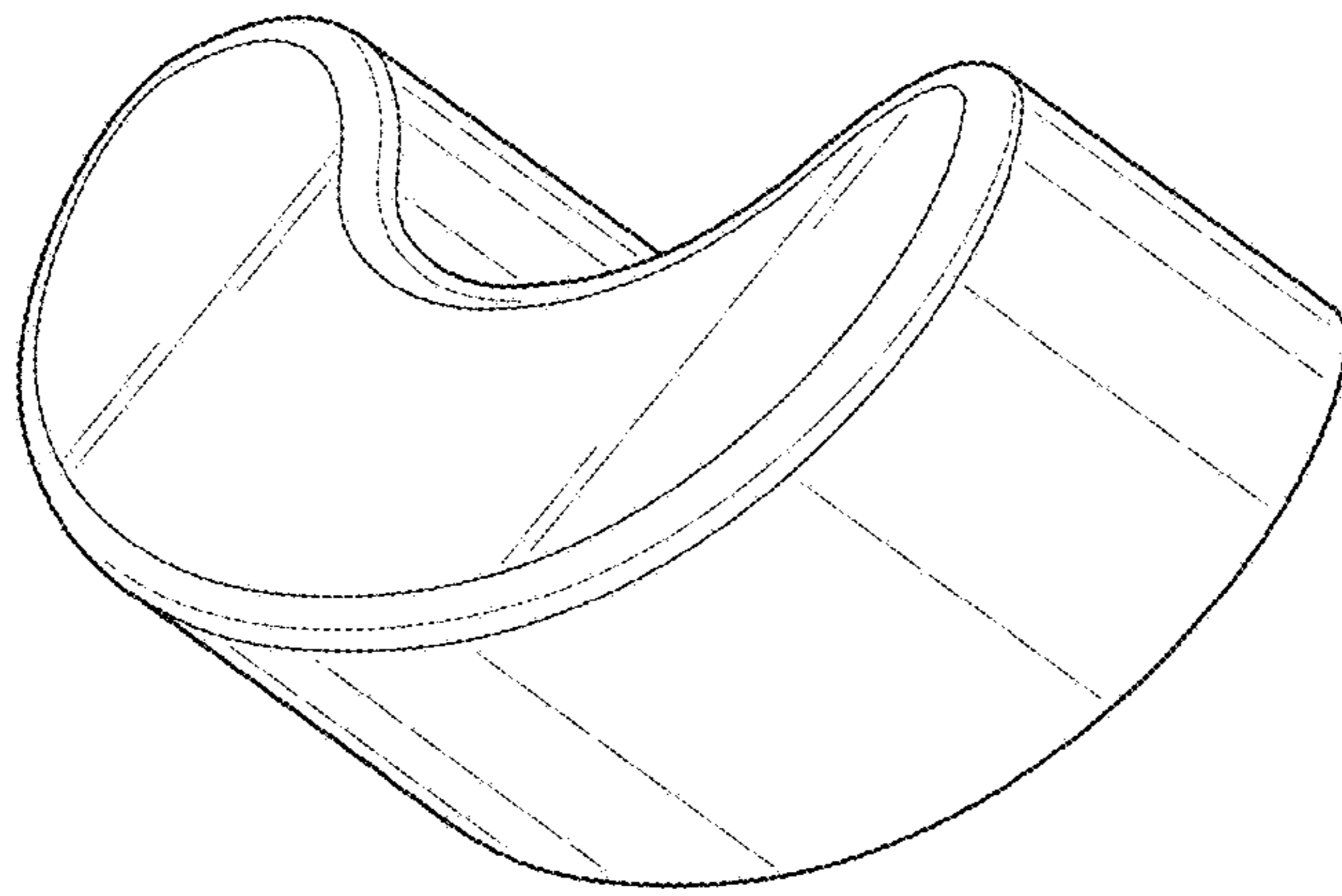

FIG. 1

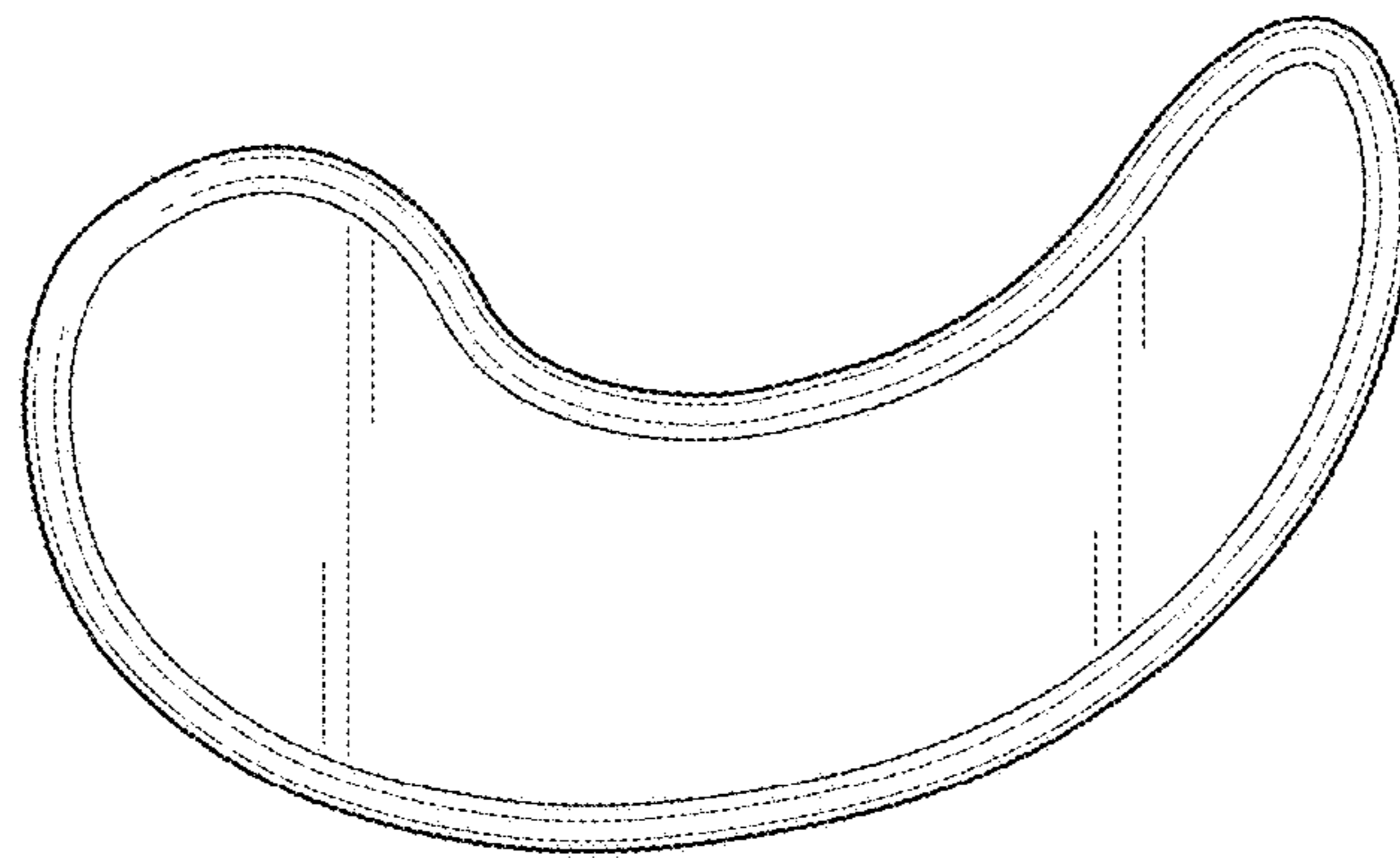

FIG. 2

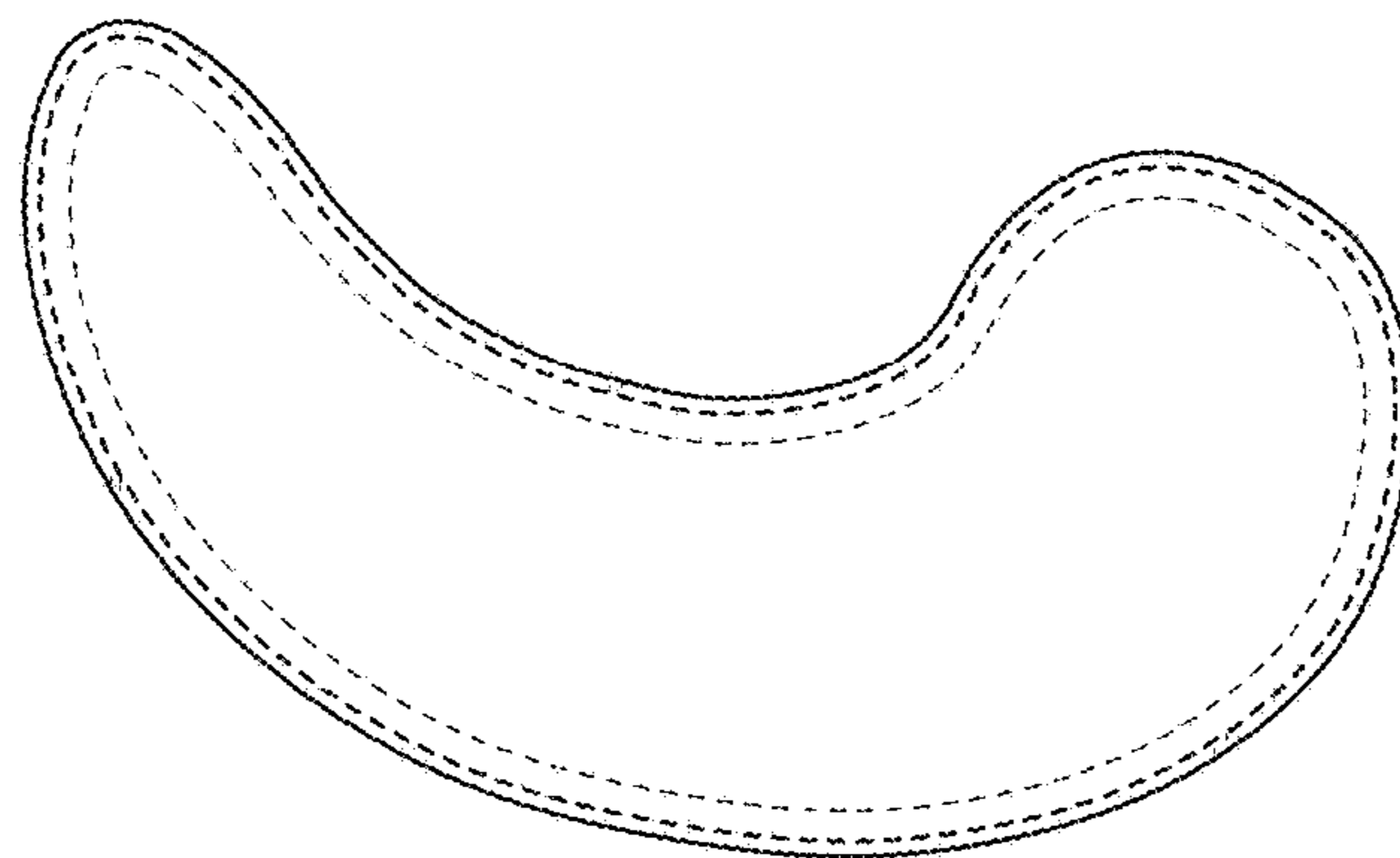

FIG. 3

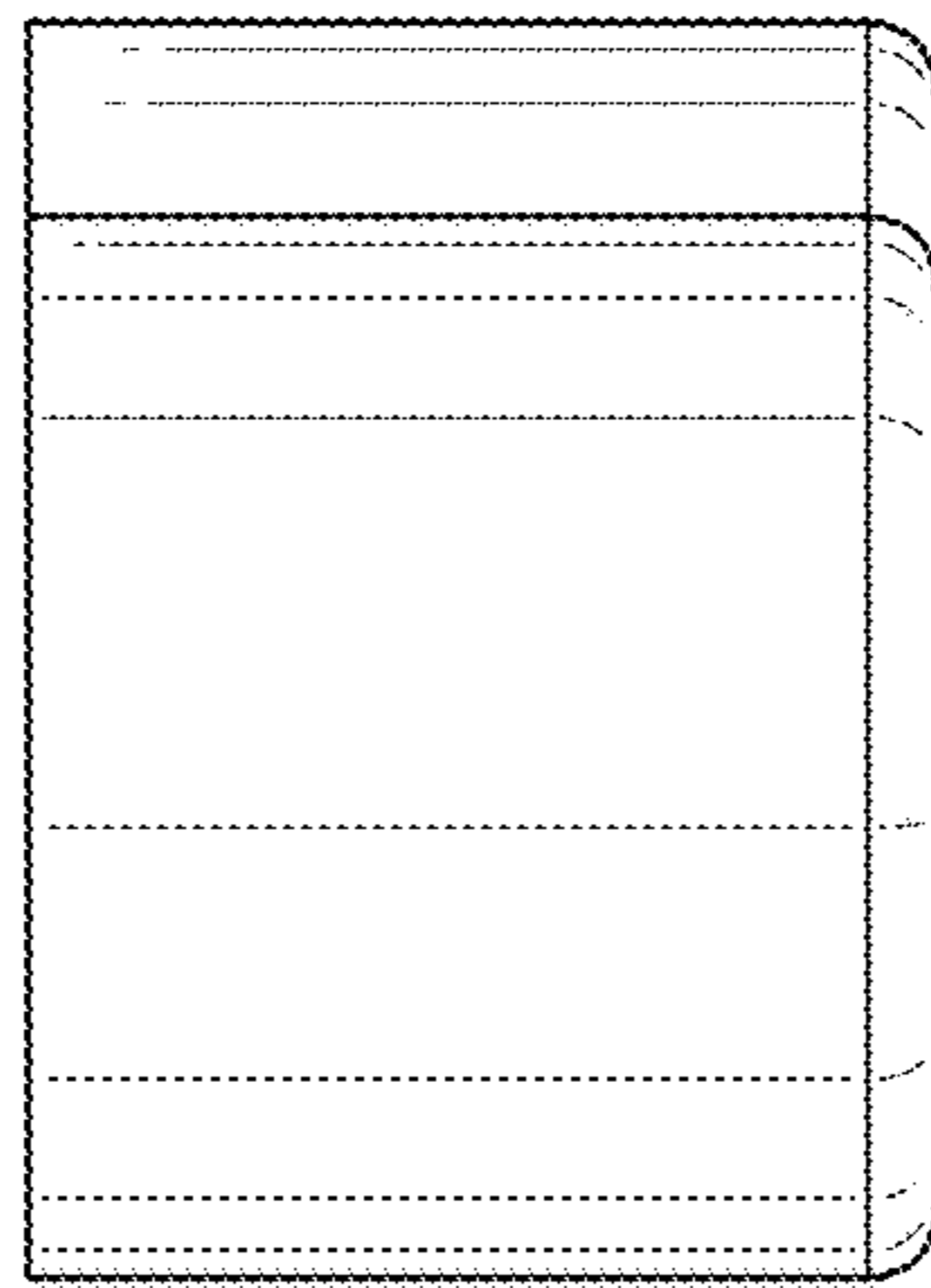

FIG. 4

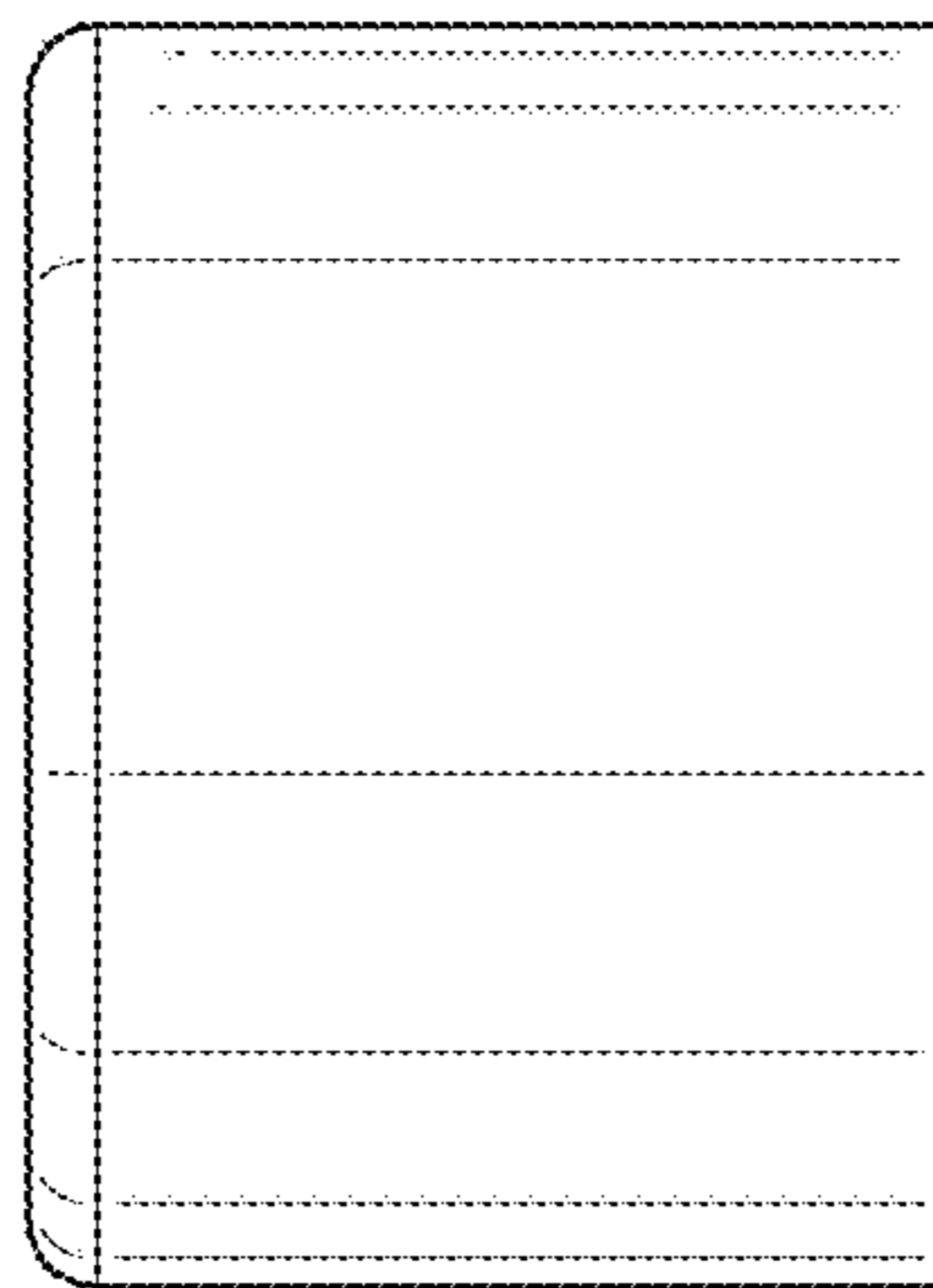

FIG. 5

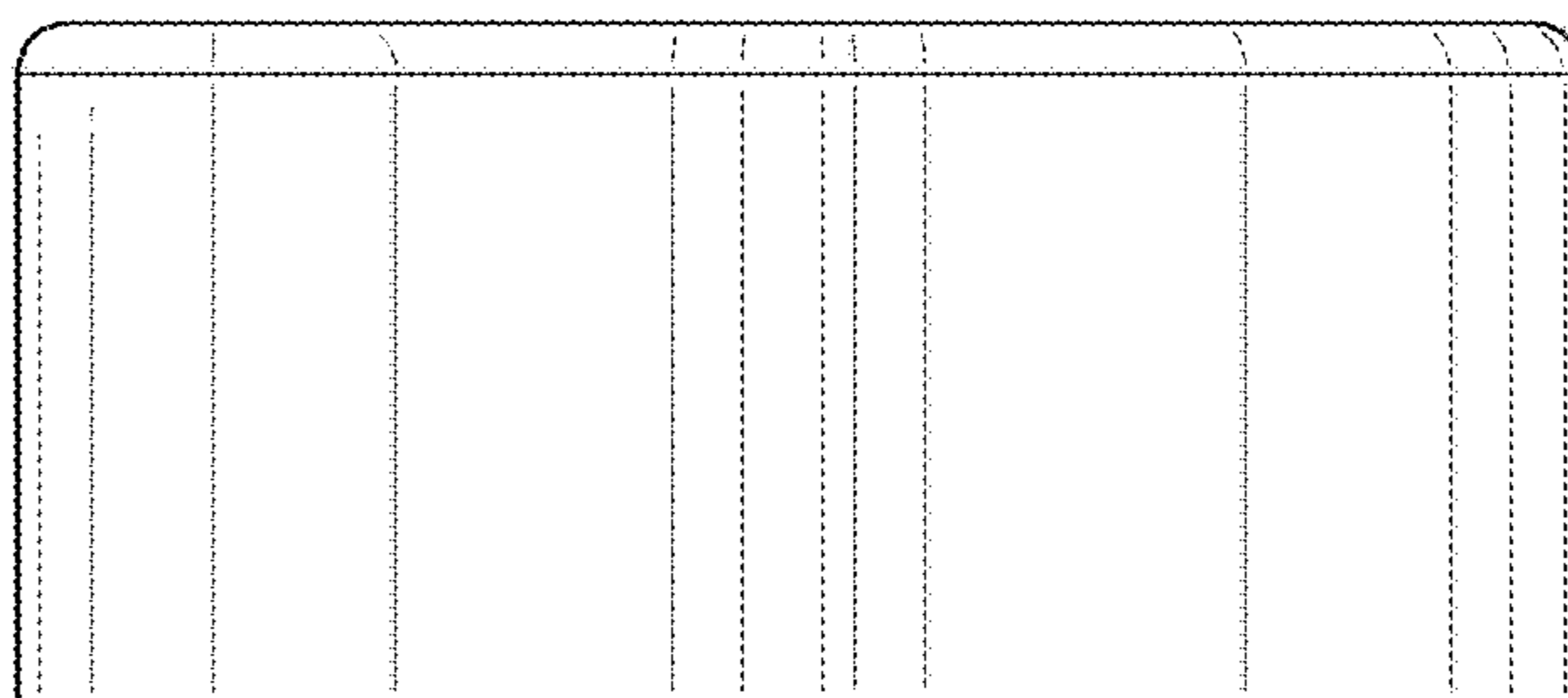

FIG. 6

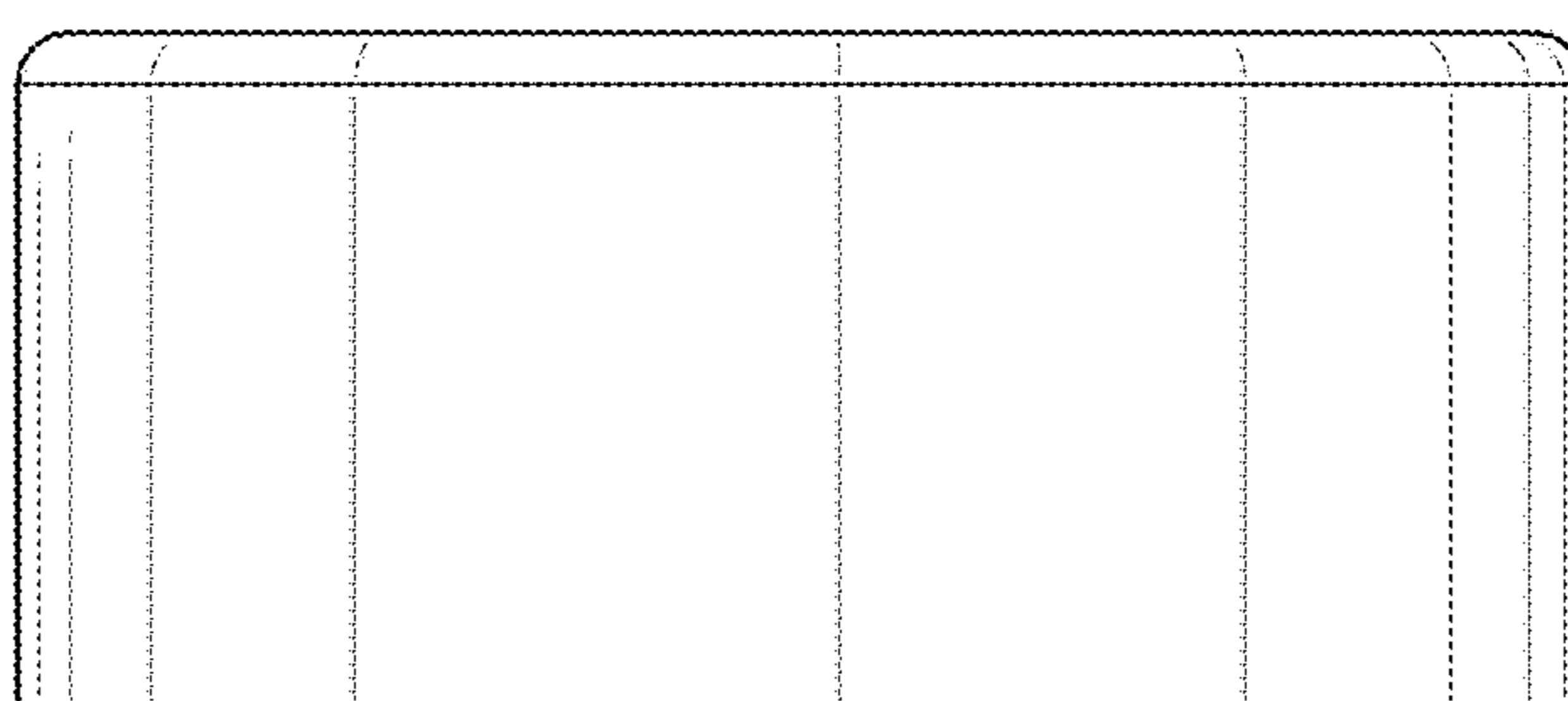

FIG. 7

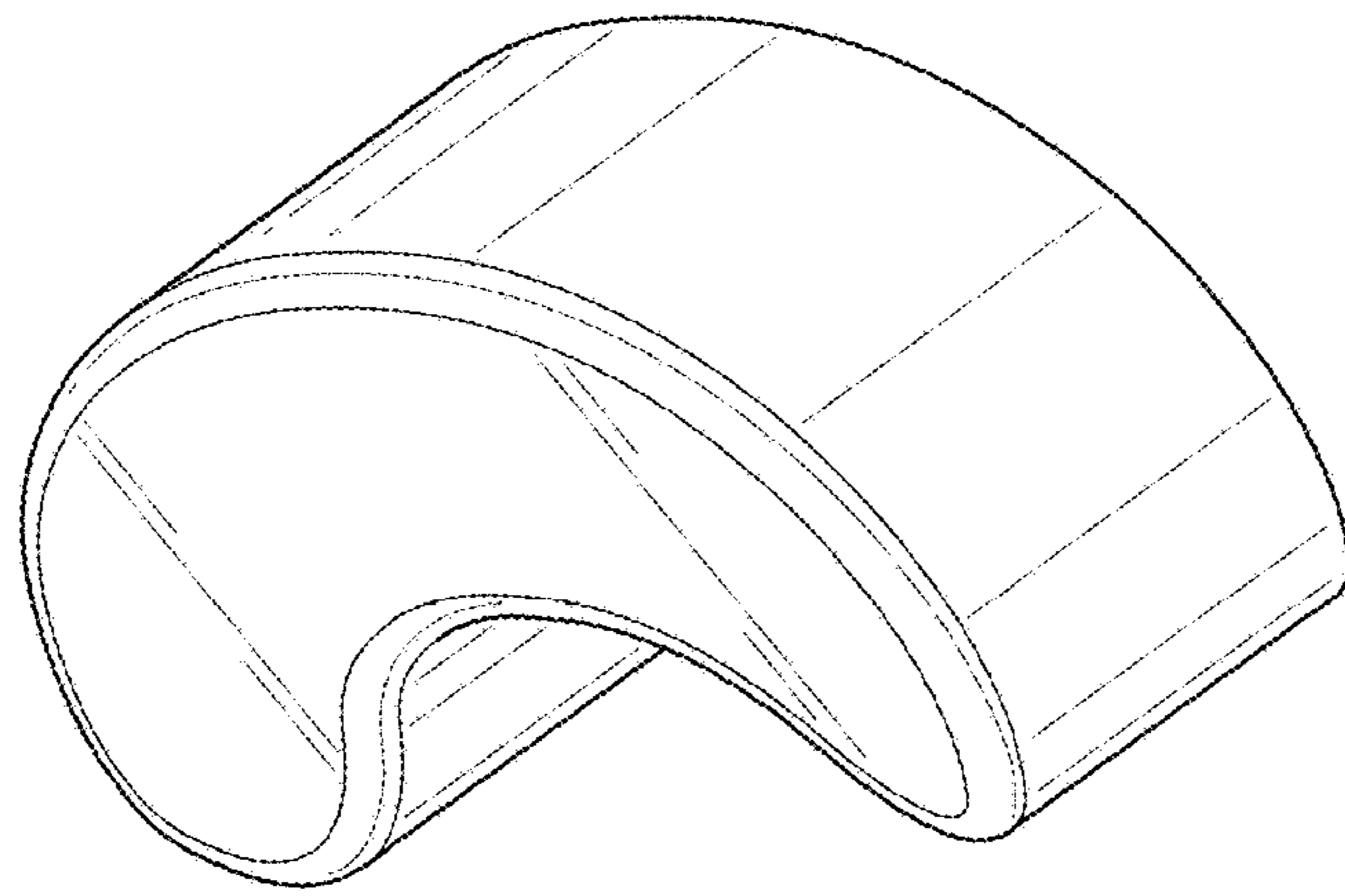

FIG. 8

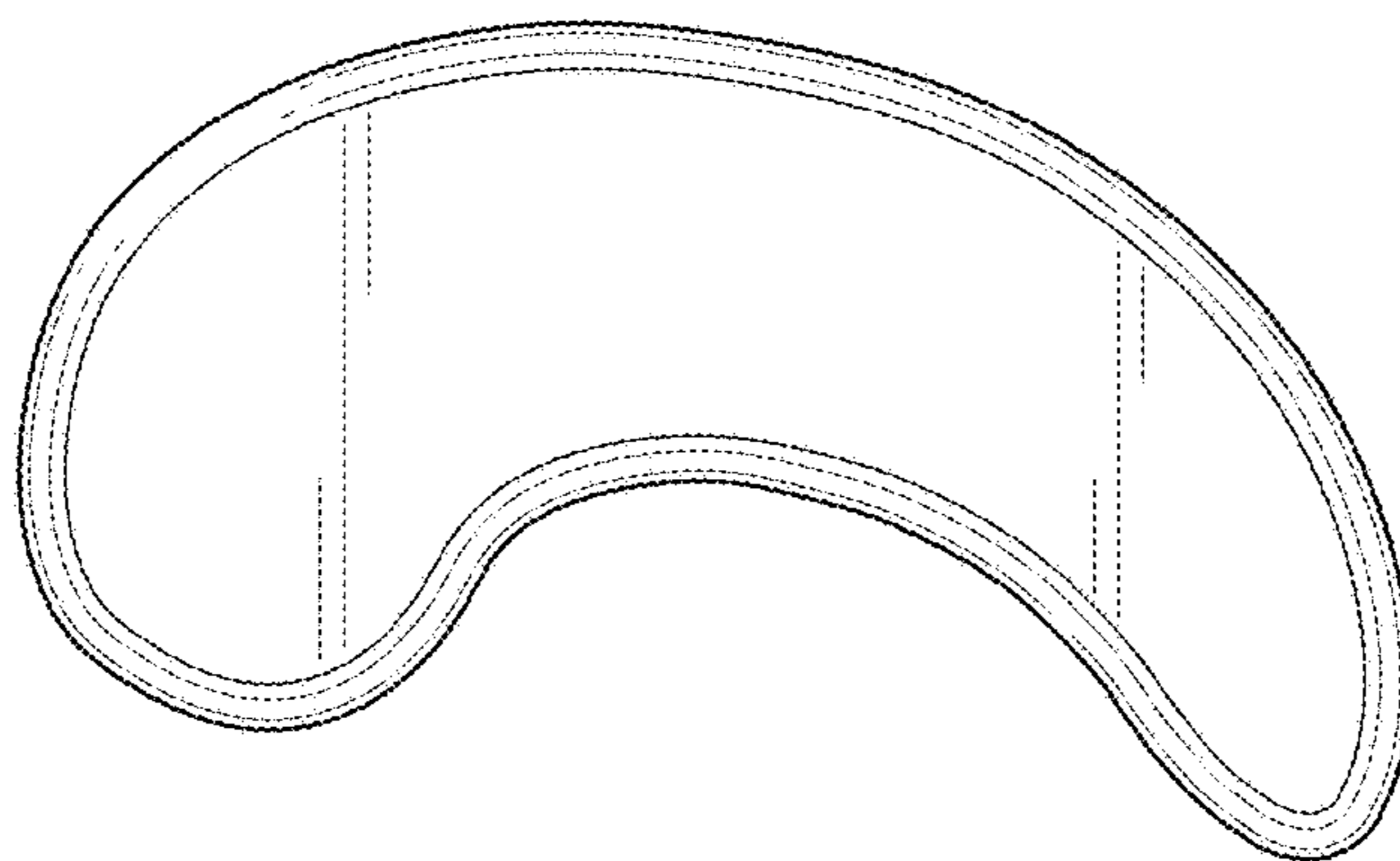

FIG. 9

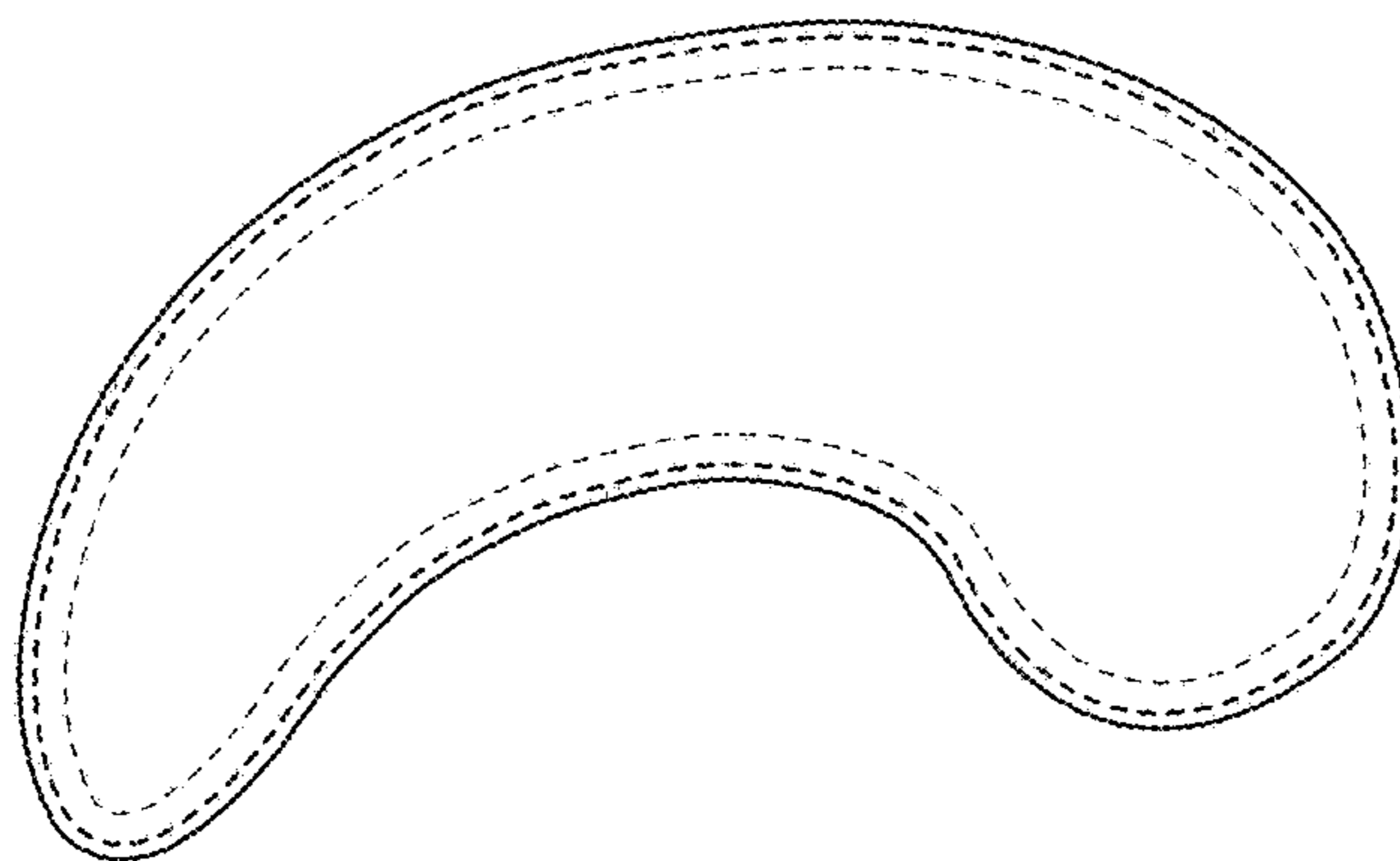

FIG. 10

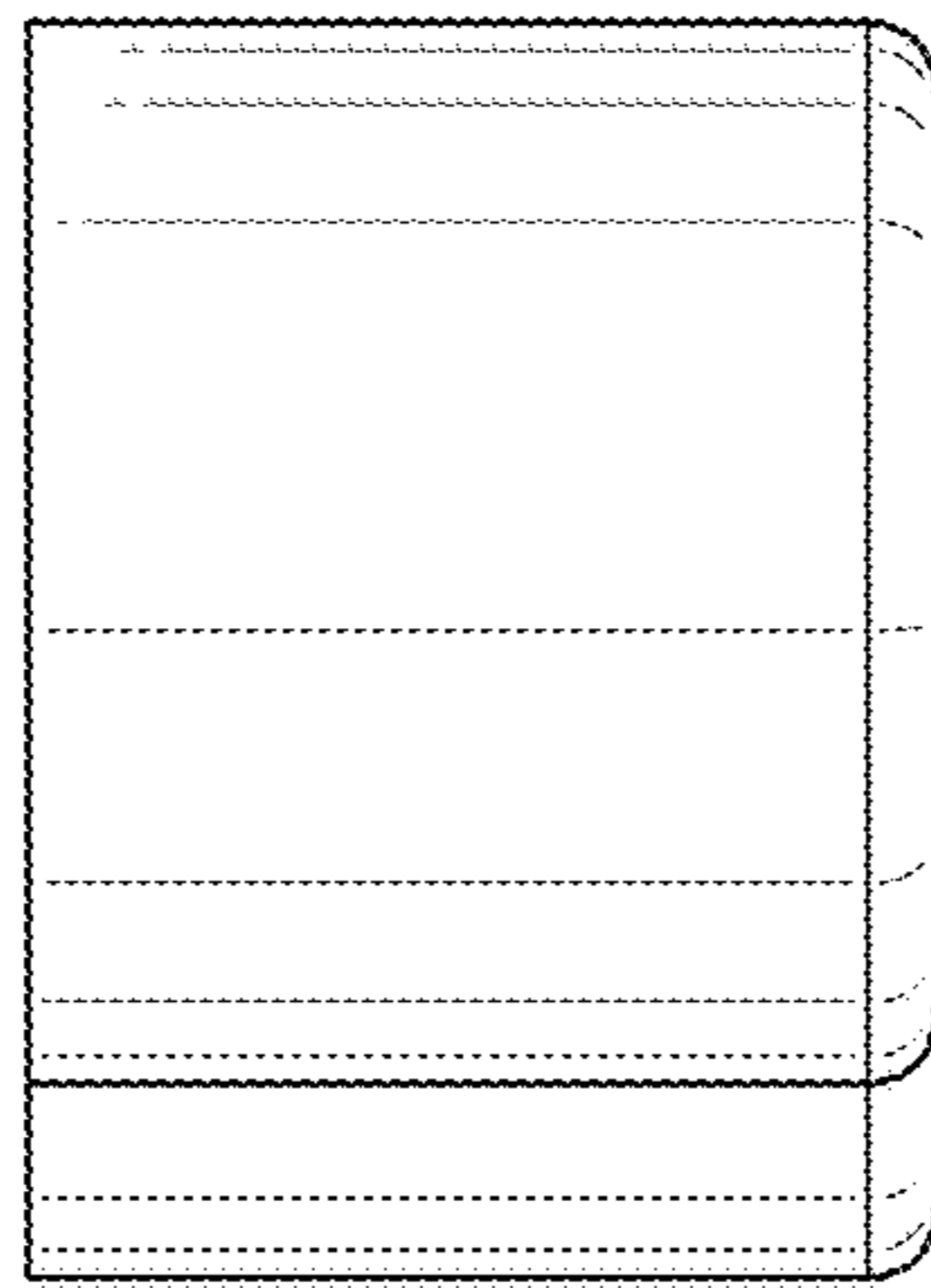

FIG. 11

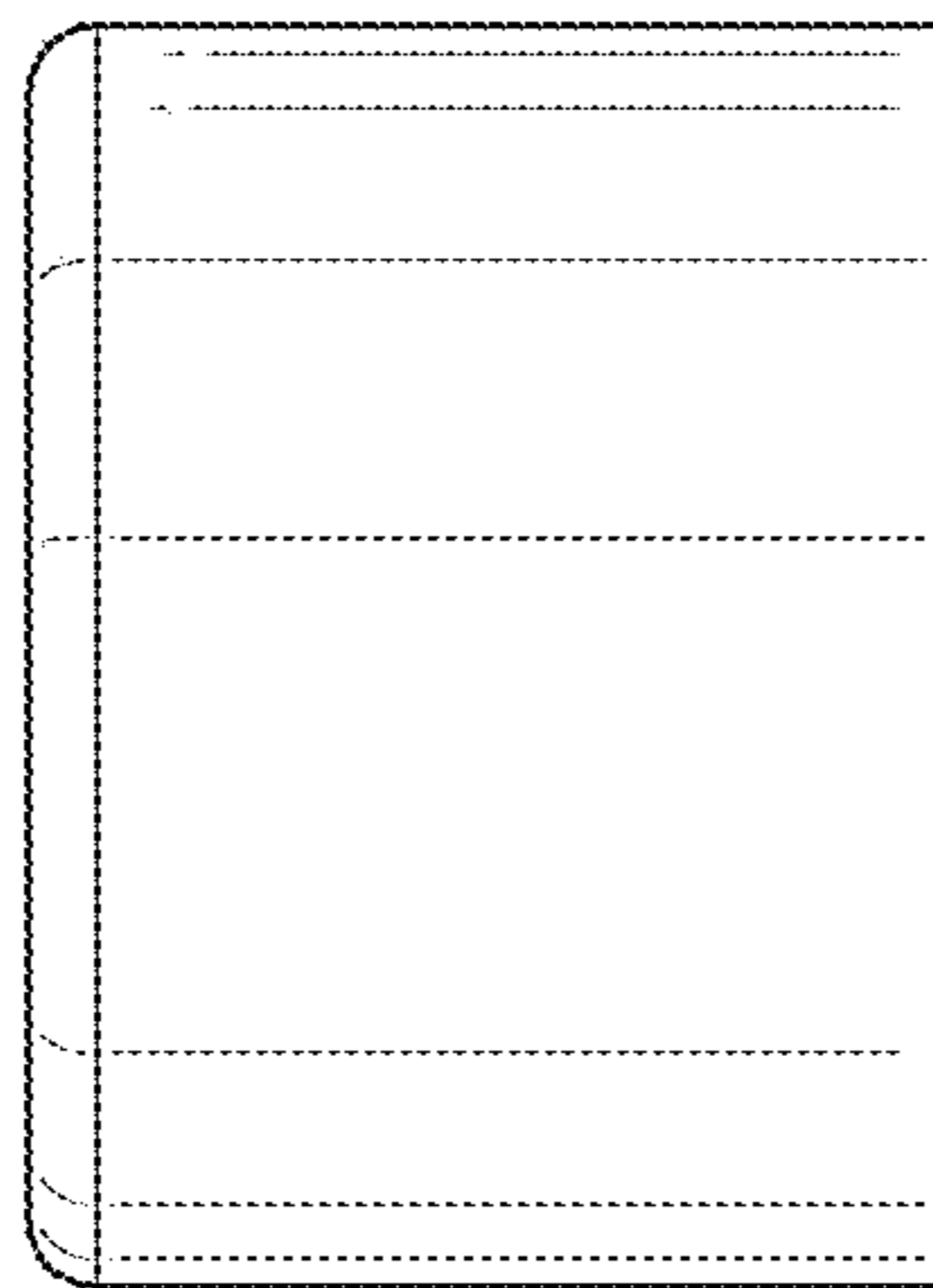

FIG. 12

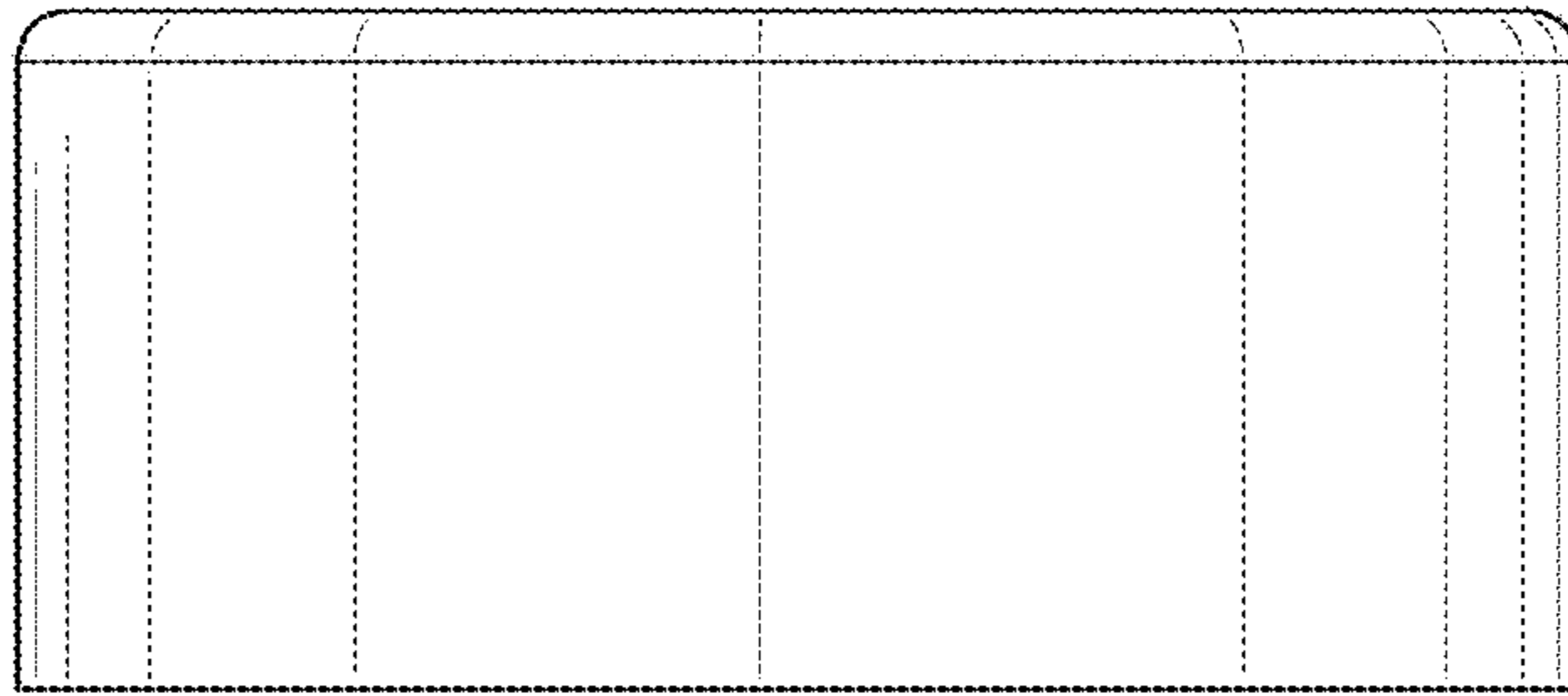

FIG. 13

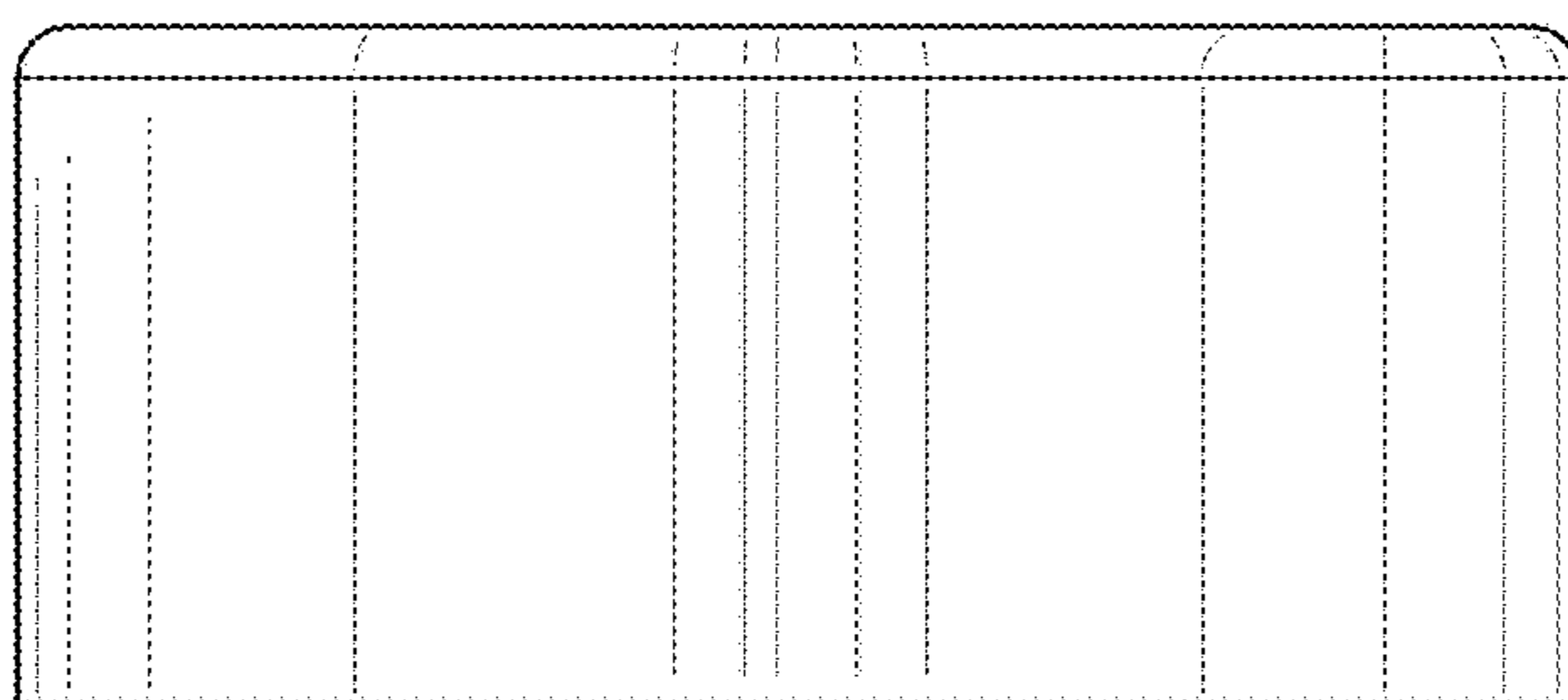

FIG. 14