



US00D845923S

(12) **United States Design Patent**
Nishikawa

(10) **Patent No.:** **US D845,923 S**

(45) **Date of Patent:** **** Apr. 16, 2019**

(54) **MOBILE PHONE**

(71) Applicant: **KYOCERA Corporation**, Kyoto-shi,
Kyoto (JP)

(72) Inventor: **Tadamichi Nishikawa**, Yokohama (JP)

(73) Assignee: **KYOCERA Corporation**, Kyoto-shi,
Kyoto (JP)

(**) Term: **15 Years**

(21) Appl. No.: **29/605,552**

(22) Filed: **May 26, 2017**

(30) **Foreign Application Priority Data**

Apr. 24, 2017 (JP) 2017-008689

(51) **LOC (11) Cl.** **14-03**

(52) **U.S. Cl.**
USPC **D14/138 AA**

(58) **Field of Classification Search**
USPC D14/137, 138 AA, 138 AB, 138 R, 147,
D14/148, 203.7, 250, 496, 191, 159, 218,
D14/299, 248, 341, 343, 203.1, 203.3;
D10/106.1, 65, 104.1, 70; D13/107;
D24/186; D21/133, 324, 329
CPC H04B 1/3827; H04B 1/3833; H04B
2001/3861; H04M 1/03; H04M 1/035;
H04M 1/026; H04M 1/02; H04M 1/0279;
H04M 1/0266; G08B 21/0202; G06F
1/1626
See application file for complete search history.

(56) **References Cited**

U.S. PATENT DOCUMENTS

D479,514 S * 9/2003 Chan D14/138 AA
D601,530 S * 10/2009 Park D14/138 AA
D641,334 S * 7/2011 Hong D14/138 AA

D682,240 S * 5/2013 Hirota D14/138 AB
D687,806 S * 8/2013 Hachiya D14/138 G
D709,475 S * 7/2014 Hirota D14/138 AA
D721,348 S * 1/2015 Plaschke D14/138 AA
D777,133 S * 1/2017 Ishii D14/138 AB
D778,861 S * 2/2017 Guo D14/138 AA
D791,731 S * 7/2017 Aihara D14/138 G
D819,590 S * 6/2018 Nakagawa D14/137
2018/0343334 A1 * 11/2018 Otani H04M 1/2535

FOREIGN PATENT DOCUMENTS

JP 1590705 * 11/2017

OTHER PUBLICATIONS

BLU Tank Xtreme 2.4, Jan. 2017, [online], [site visited Dec. 19, 2018]. Retrieved from url:https://www.gsmarena.com/blu_tank_xtreme_2_4-pictures-8526.php (Year: 2017).*

(Continued)

Primary Examiner — Jeffrey D Asch

Assistant Examiner — Tracey J Bell

(74) *Attorney, Agent, or Firm* — Kenja IP Law PC

(57) **CLAIM**

The ornamental design for a mobile phone, as shown and described.

DESCRIPTION

FIG. 1 is a front perspective view of a mobile phone showing my new design;
FIG. 2 is a rear perspective view thereof;
FIG. 3 is a front view thereof;
FIG. 4 is a rear view thereof;
FIG. 5 is a right side view thereof;
FIG. 6 is a left side view thereof;
FIG. 7 is a top plan view thereof; and,
FIG. 8 is a bottom view thereof.

1 Claim, 8 Drawing Sheets

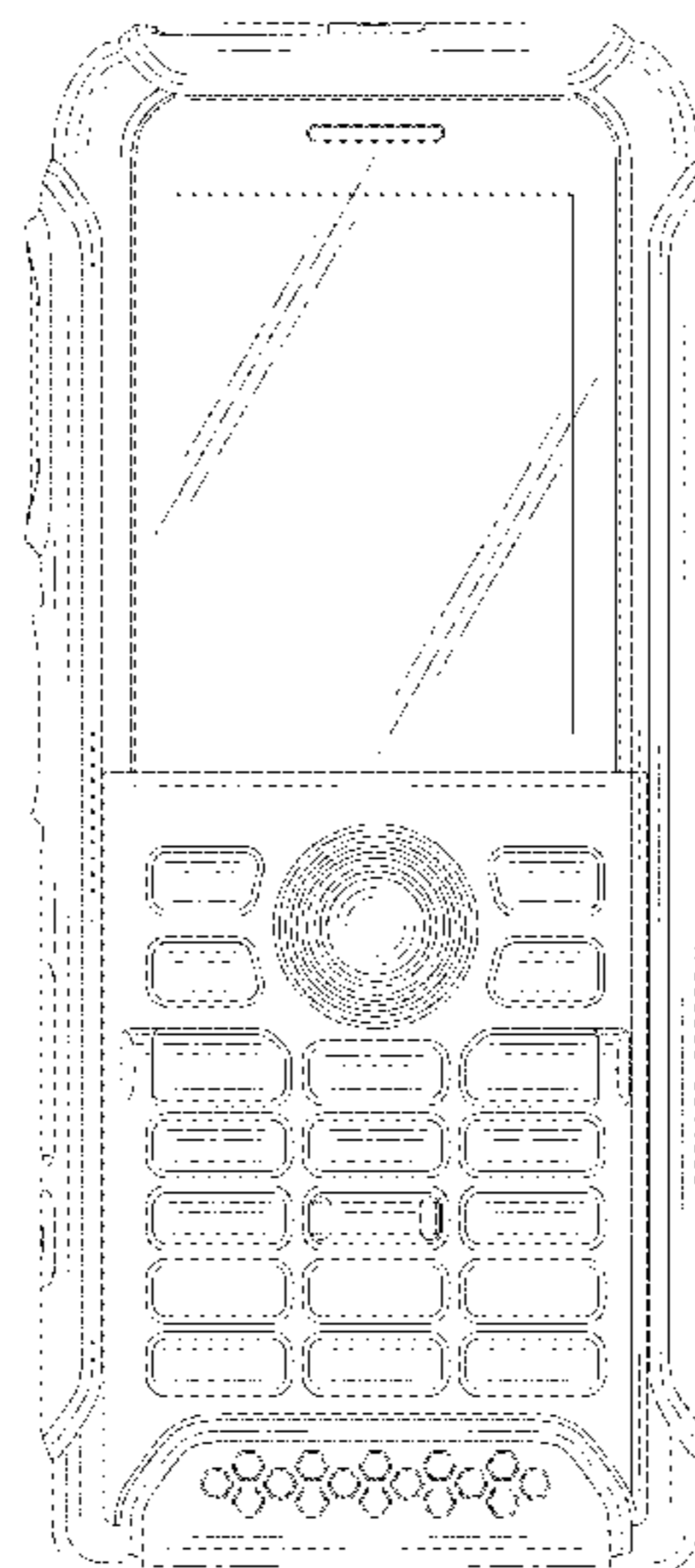
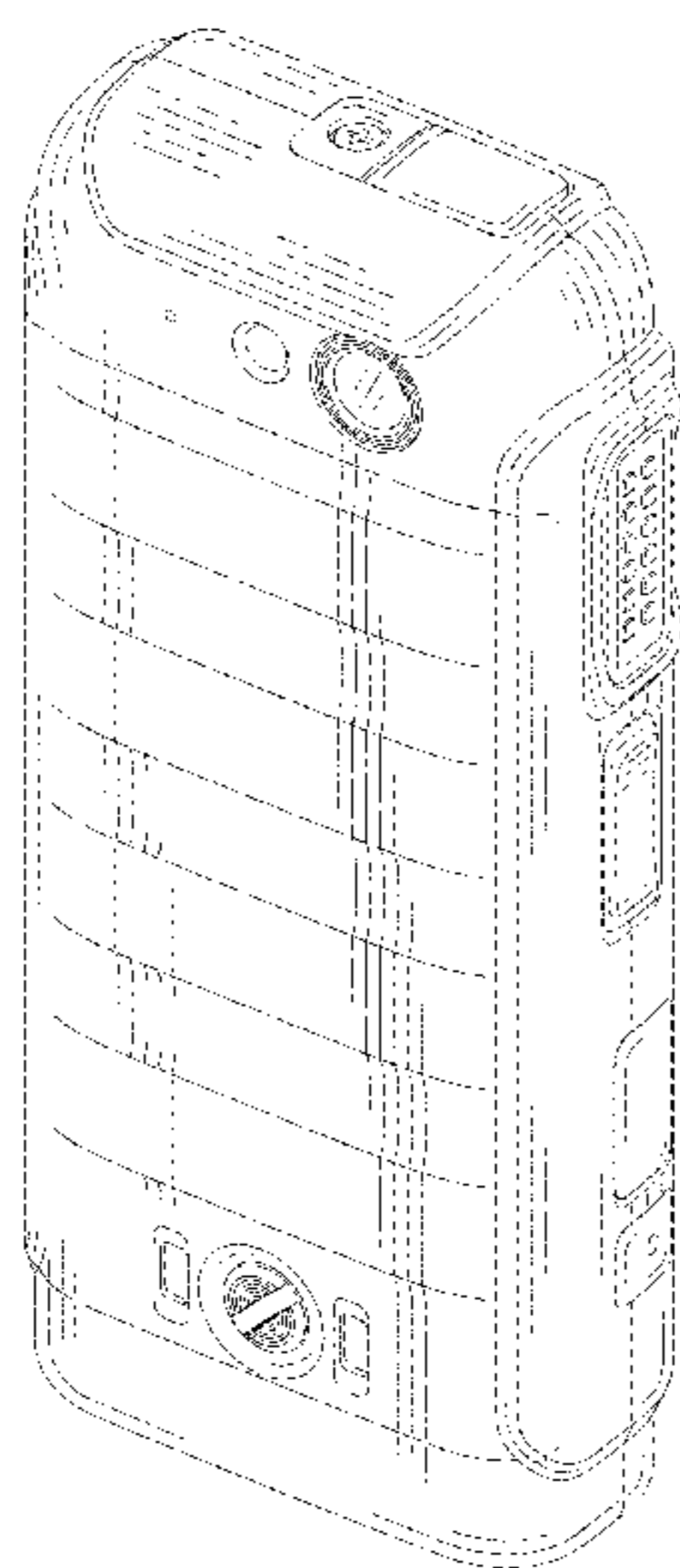

(56)

References Cited

OTHER PUBLICATIONS

Energizer Hardcase H240S, Jan. 2018, [online], [site visited Dec. 19, 2018]. Retrieved from url:https://www.gsmarena.com/energizer_hardcase_h240s-pictures-8981.php (Year: 2018).*

New Kyocera DuraPlus, Feb. 3, 2012, [online], [site visited Dec. 17, 2018]. Retrieved from url:<https://www.gizbot.com/mobile/new-kyocera-duraplus-a-high-quality-low-end-rugged-phone.html> (Year: 2012).*

www.motorolasolutions.com, Retrieved on May 24, 2017, from URL: https://www.motorolasolutions.com/en_xu/products/motrbo/dp4000-series/dp4800-dp4801.html#tabproductinfo.

www.phonearena.com, Retrieved on May 16, 2017, from URL: http://www.phonearena.com/phones/Kyocera-DuraPlus_id6875.

www.phonearena.com, Retrieved on May 8, 2017, from URL: http://www.phonearena.com/phones/Sonim-XP5_id9493.

www.phonearena.com, Retrieved on May 8, 2017, from URL: http://www.phonearena.com/phones/Sonim-XP5300-Force-3G_id6260.

* cited by examiner

FIG. 1

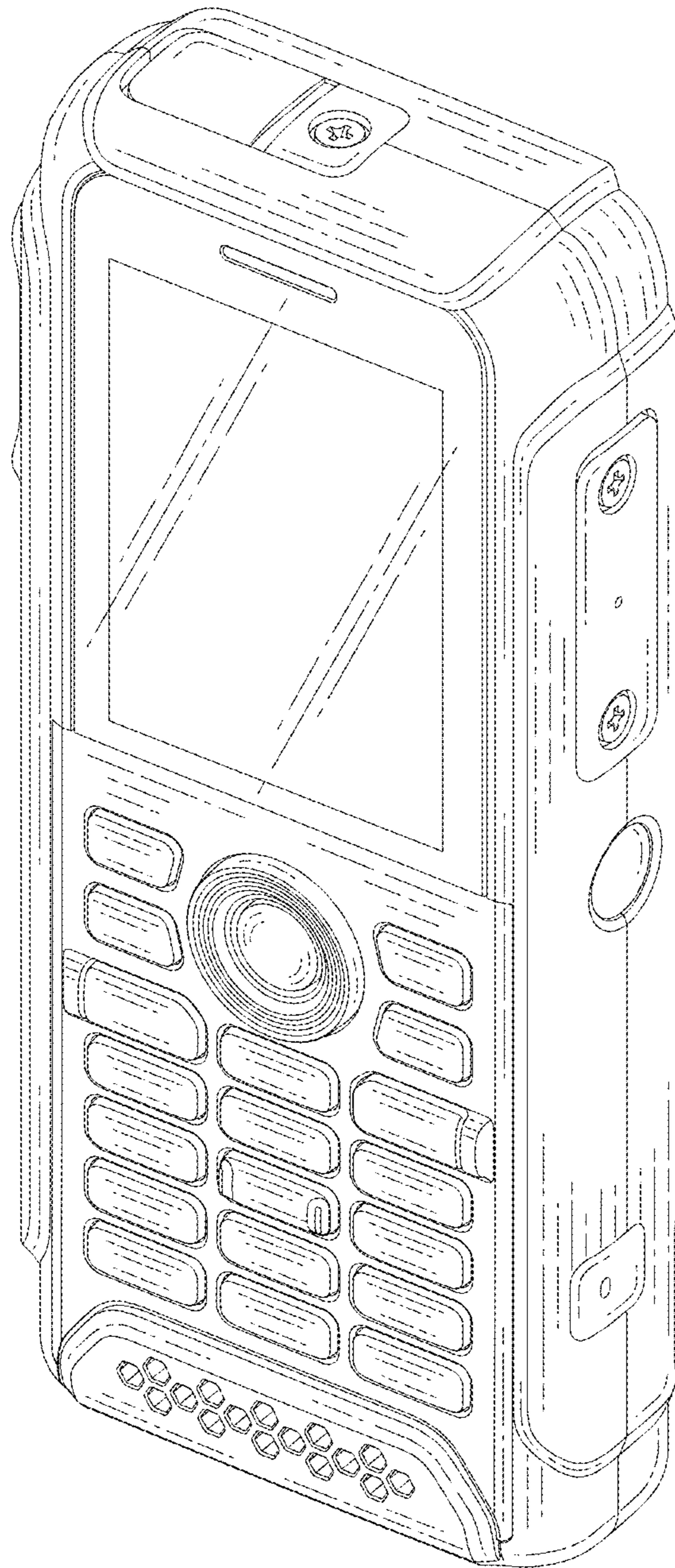

FIG. 2

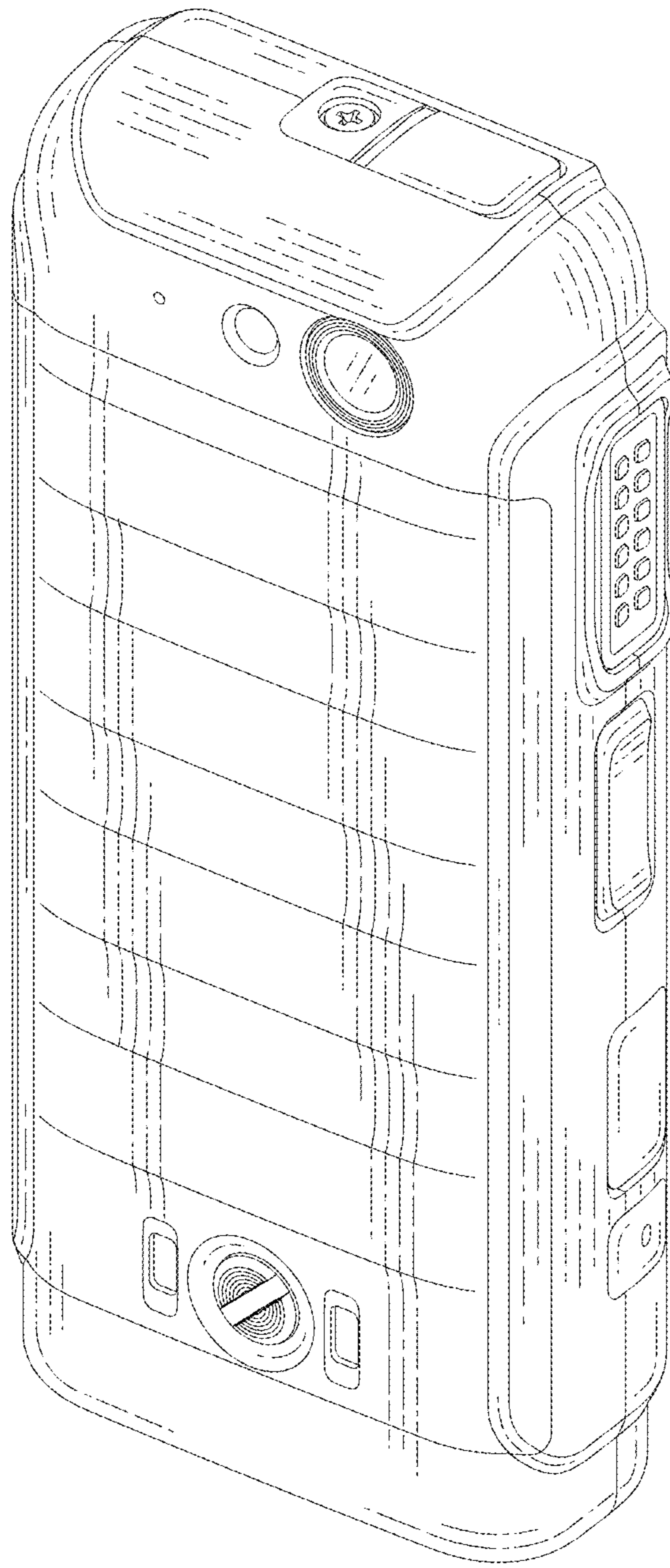

FIG. 3

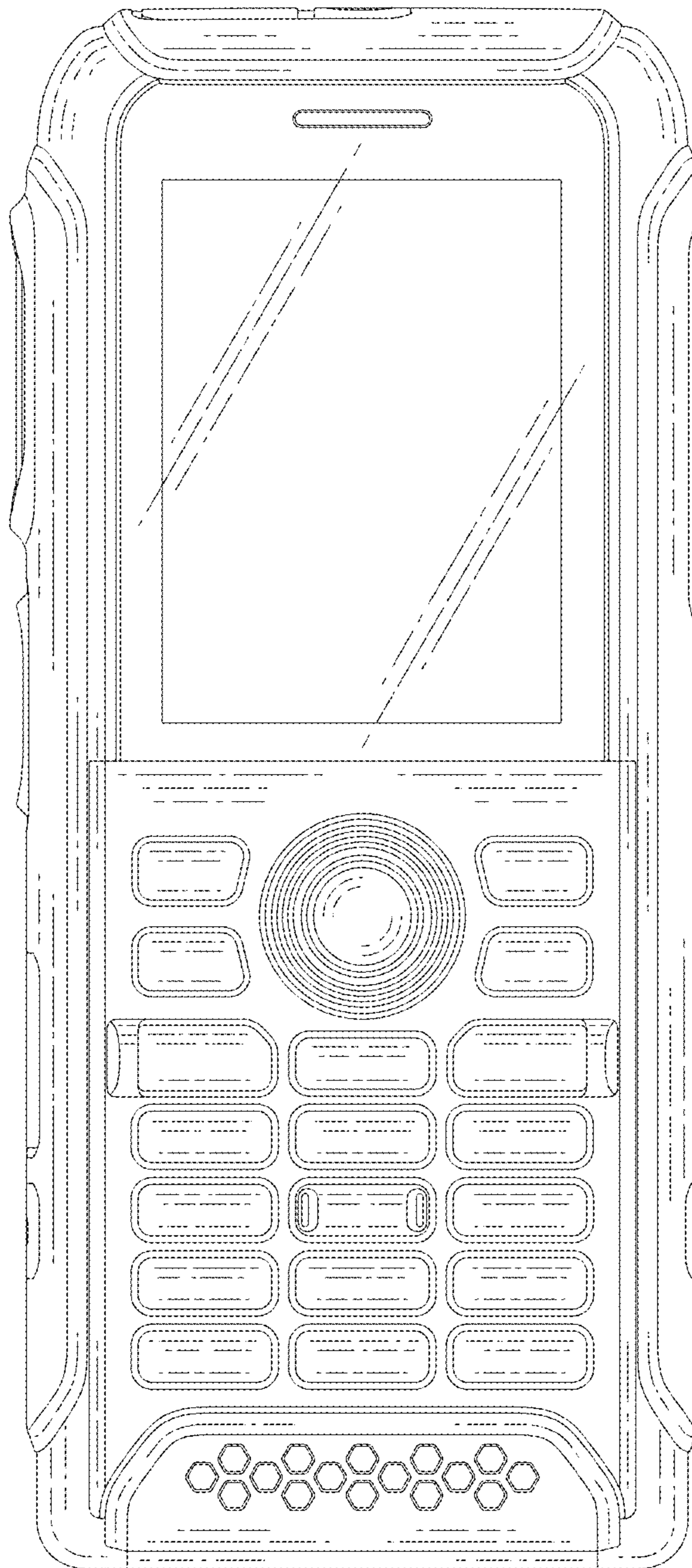

FIG. 4

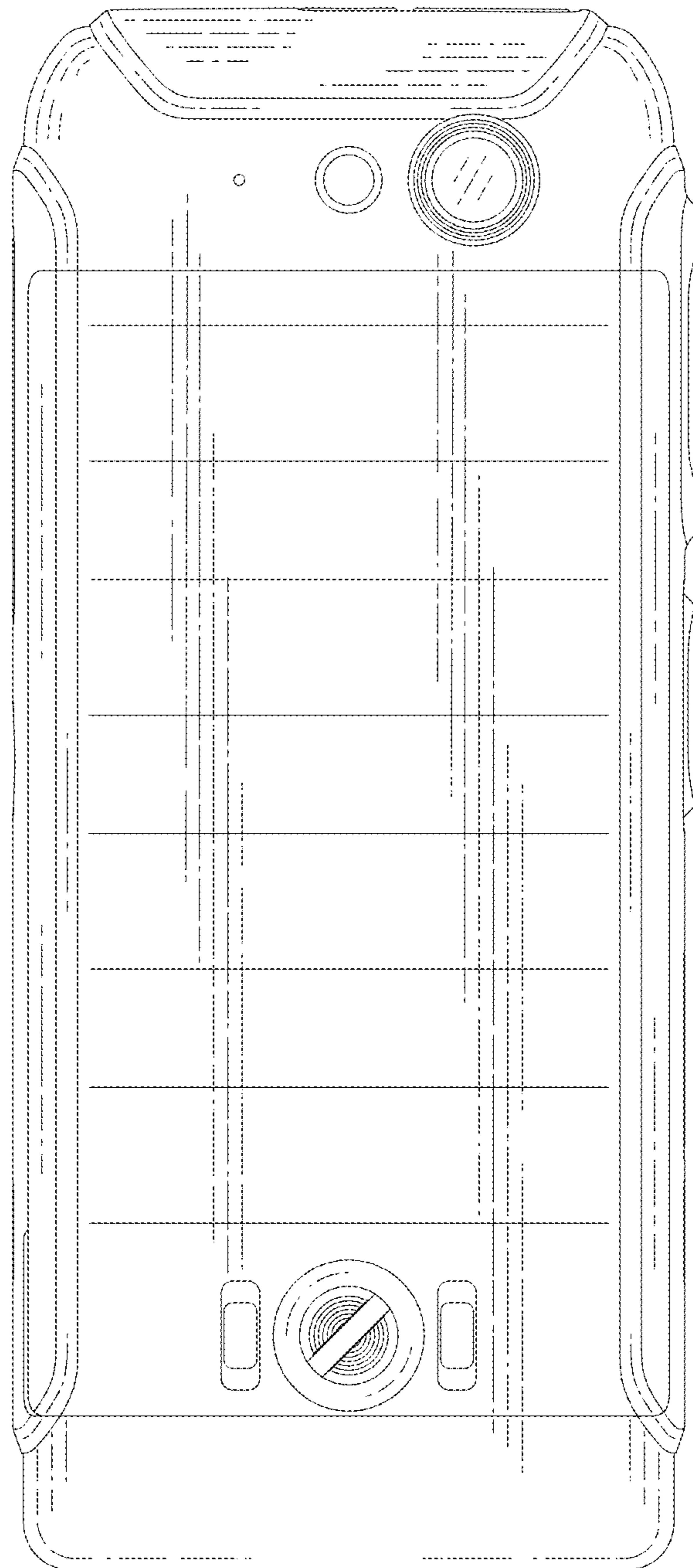

FIG. 5

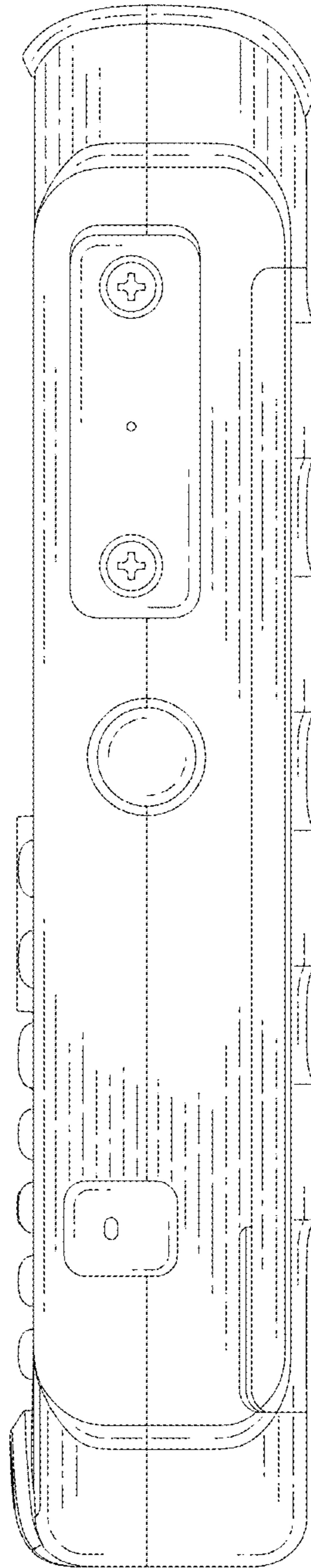

FIG. 6

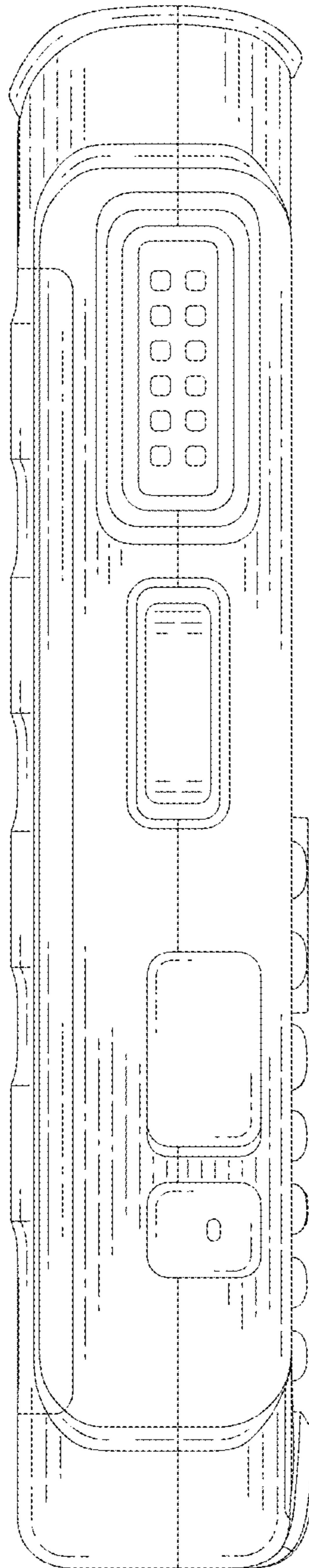

FIG. 7

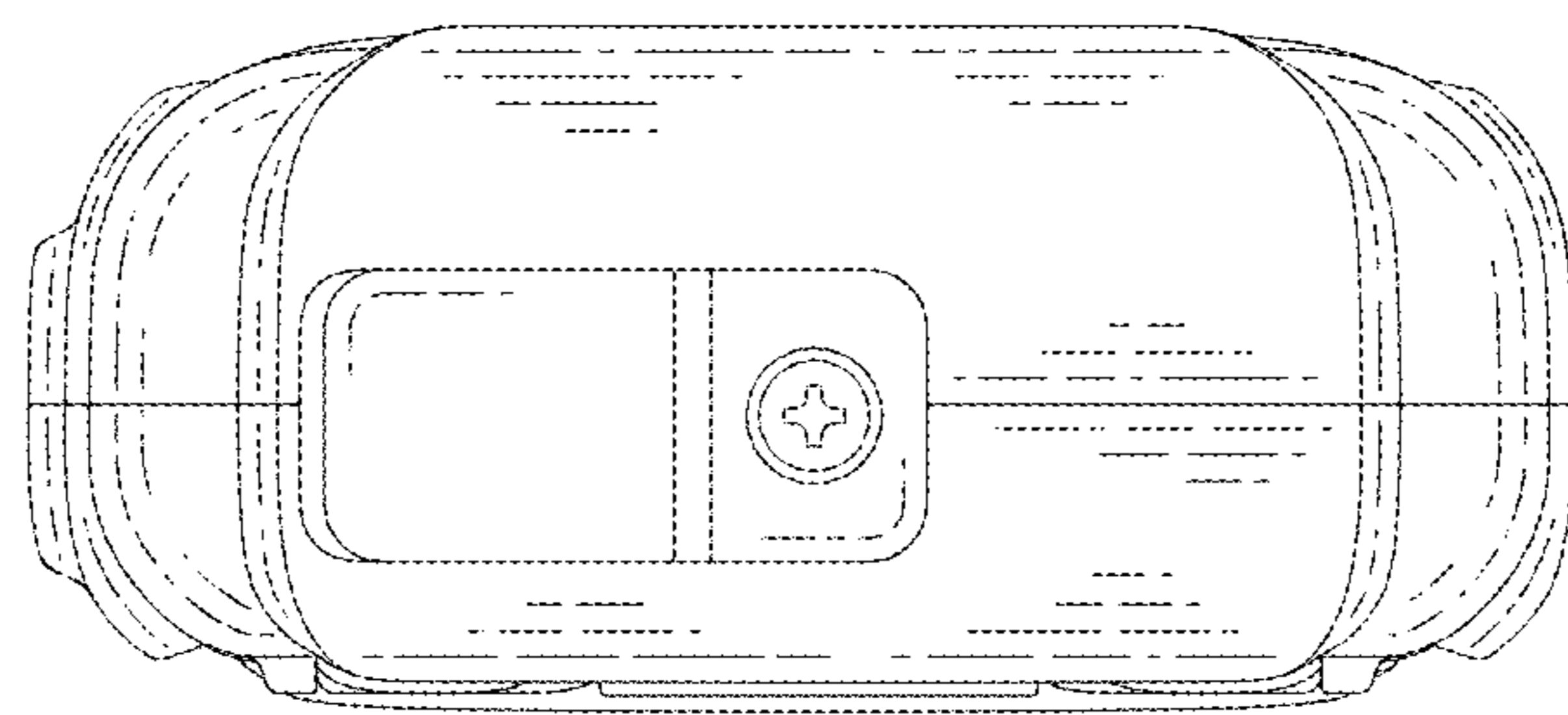

FIG. 8

