



US00D845869S

(12) **United States Design Patent**
Wymore

(10) **Patent No.:** **US D845,869 S**
(45) **Date of Patent:** **** Apr. 16, 2019**

(54) **VEHICLE SPORT BAR WITH REMOVABLE DECORATIVE PANELS**

(71) Applicant: **IDDEA CALIFORNIA, LLC**, Brea, CA (US)

(72) Inventor: **Timothy J. Wymore**, Yorba Linda, CA (US)

(73) Assignee: **Iddea California, LLC**, Brea, CA (US)

(**) Term: **15 Years**

(21) Appl. No.: **29/568,747**

(22) Filed: **Jun. 21, 2016**

(51) **LOC (11) Cl.** **12-16**

(52) **U.S. Cl.**
USPC **D12/222**

(58) **Field of Classification Search**
USPC D12/414, 415, 416, 417, 418, 419, 420, D12/421, 422, 423, 424, 425, 426, 190, D12/192, 195, 191, 106, 345, 96, 99, 400, D12/222, 406, 412, 223
CPC B60R 9/045; B60R 21/13; B60R 9/00; B60R 7/04; B60R 7/08; B60R 13/04; B60Q 1/2611; B60Q 1/30; B60J 7/102
See application file for complete search history.

(56) **References Cited**

U.S. PATENT DOCUMENTS

D244,268 S	5/1977	Hinch	
4,148,504 A *	4/1979	Rushing B60R 21/13 182/153
4,152,020 A	5/1979	Brown et al.	
D253,170 S	10/1979	Ramirez	
4,211,448 A	7/1980	Weston	
4,267,948 A	5/1981	Lewis	
4,278,175 A	7/1981	Jackson	
4,659,131 A	4/1987	Flournoy	
D295,084 S	4/1988	Weber	
4,795,188 A *	1/1989	Dueker B60R 21/13 280/756

4,854,628 A	8/1989	Halberg	
D305,111 S	12/1989	Zagner	
D306,848 S	3/1990	Macor	
5,000,480 A *	3/1991	Straka B60Q 1/2611 280/748
5,002,324 A	3/1991	Griffin	

(Continued)

OTHER PUBLICATIONS

Youtube.com. "Go Rhino Sport Bar 2.0 with Power-Actuated Retractable Light Mount (91100T & (960001T))" Uploaded Dec. 23, 2016. Retrieved May 9, 2017. (https://www.youtube.com/watch?v=DtoOgdmab_8).

Primary Examiner — Susan E Krakower
Assistant Examiner — Jerry Shiuan-Hua Hsu
(74) *Attorney, Agent, or Firm* — Stetina Brunda Garred and Brucker

(57) **CLAIM**

The ornamental design for a vehicle sport bar with removable decorative panels, as shown and described.

DESCRIPTION

FIG. 1 is a front perspective view of the vehicle sport bar with removable decorative panels of the present invention showing my new design; FIG. 2 is a front elevational view thereof; FIG. 3 is a rear elevational view thereof; FIG. 4 is a left side view thereof; FIG. 5 is a right side view thereof; FIG. 6 is a top plan view thereof; and, FIG. 7 is a bottom plan view thereof. The broken lines illustrating the lights and light mounts depict environmental subject matter that forms no part of the claimed design. The remaining broken lines depict portions of the vehicle sports bar with removable decorative panels that form no part of the claimed design.

1 Claim, 5 Drawing Sheets

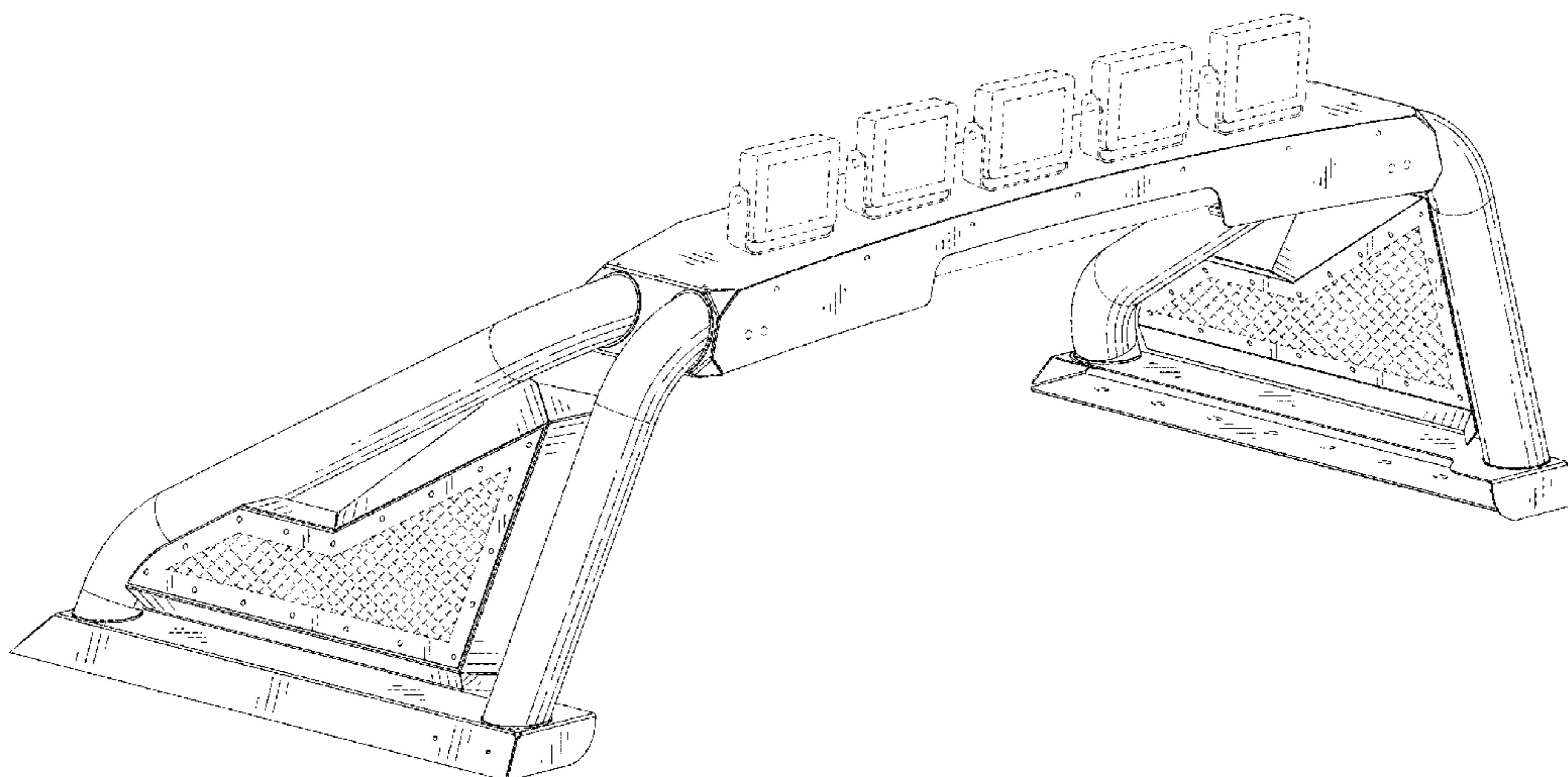

(56)

References Cited

U.S. PATENT DOCUMENTS

D316,391 S 4/1991 Lund
 D318,447 S 7/1991 Haugen et al.
 5,037,152 A 8/1991 Hendricks
 5,061,000 A 10/1991 Haugen et al.
 5,121,306 A * 6/1992 Palmisano B60R 9/00
 224/404
 5,143,415 A 9/1992 Boudah
 5,152,570 A 10/1992 Hood
 5,192,107 A 3/1993 Smith
 5,258,893 A * 11/1993 Finneyfrock B60Q 1/30
 280/748
 5,303,858 A 4/1994 Price
 5,316,190 A * 5/1994 Bullock B60P 3/42
 211/182
 D360,614 S 7/1995 Alcocer
 D363,460 S 10/1995 Marshall
 5,476,301 A 12/1995 Berkich
 5,492,259 A 2/1996 Tippets
 D367,843 S 3/1996 Tayar
 5,560,666 A 10/1996 Vieira et al.
 5,692,791 A 12/1997 Sulzer
 D394,639 S 5/1998 Carter
 5,752,734 A 5/1998 Ward et al.
 5,806,905 A 9/1998 Moore

D399,476 S 10/1998 Duncan
 5,836,635 A 11/1998 Dorman
 D410,429 S * 6/1999 Derecktor D12/406
 D436,915 S 1/2001 Burger
 D444,446 S 7/2001 Carter
 6,367,673 B1 4/2002 Smith et al.
 6,394,524 B1 5/2002 Morse
 D463,358 S 9/2002 Thomas
 D467,862 S 12/2002 Jenkins
 6,513,849 B2 2/2003 Carter
 6,520,723 B2 2/2003 Christensen
 D493,414 S 7/2004 Condos
 D494,921 S 8/2004 Taylor
 6,883,848 B1 4/2005 Iverson et al.
 6,983,968 B2 1/2006 Brauer et al.
 6,983,977 B1 1/2006 Kozak et al.
 D515,495 S 2/2006 Storer
 D528,964 S * 9/2006 Storer D12/222
 D528,968 S * 9/2006 Storer D12/222
 D597,924 S * 8/2009 Smith D12/406
 8,915,520 B2 * 12/2014 Mantovani B60R 21/13
 280/756
 D757,316 S * 5/2016 Wymore D26/31
 2007/0132263 A1 * 6/2007 Smith B60R 9/00
 296/37.6
 2018/0072244 A1 * 3/2018 Wymore B60R 13/04
 2018/0111565 A1 * 4/2018 Wymore B60J 7/102

* cited by examiner

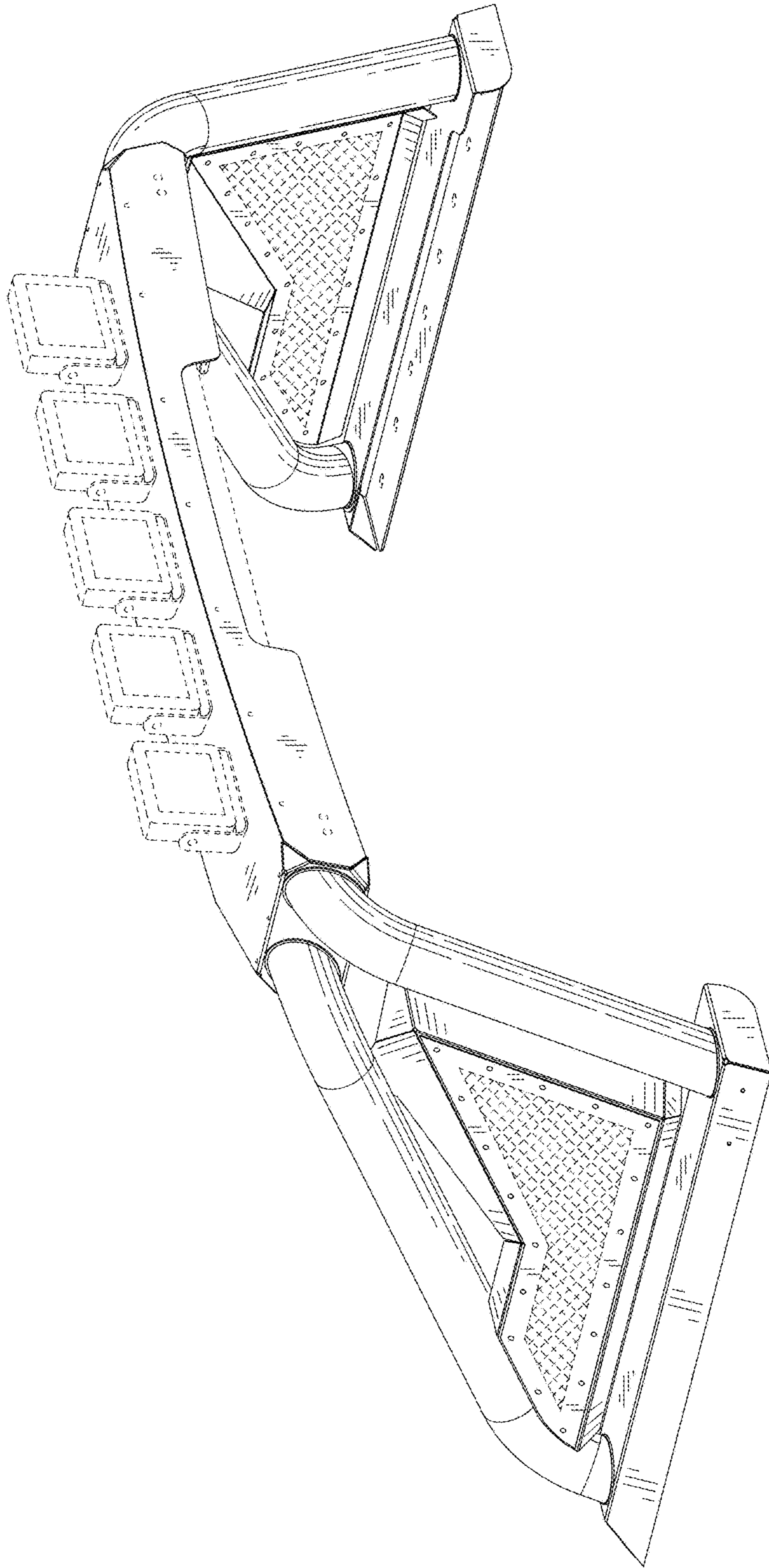

FIG. 1

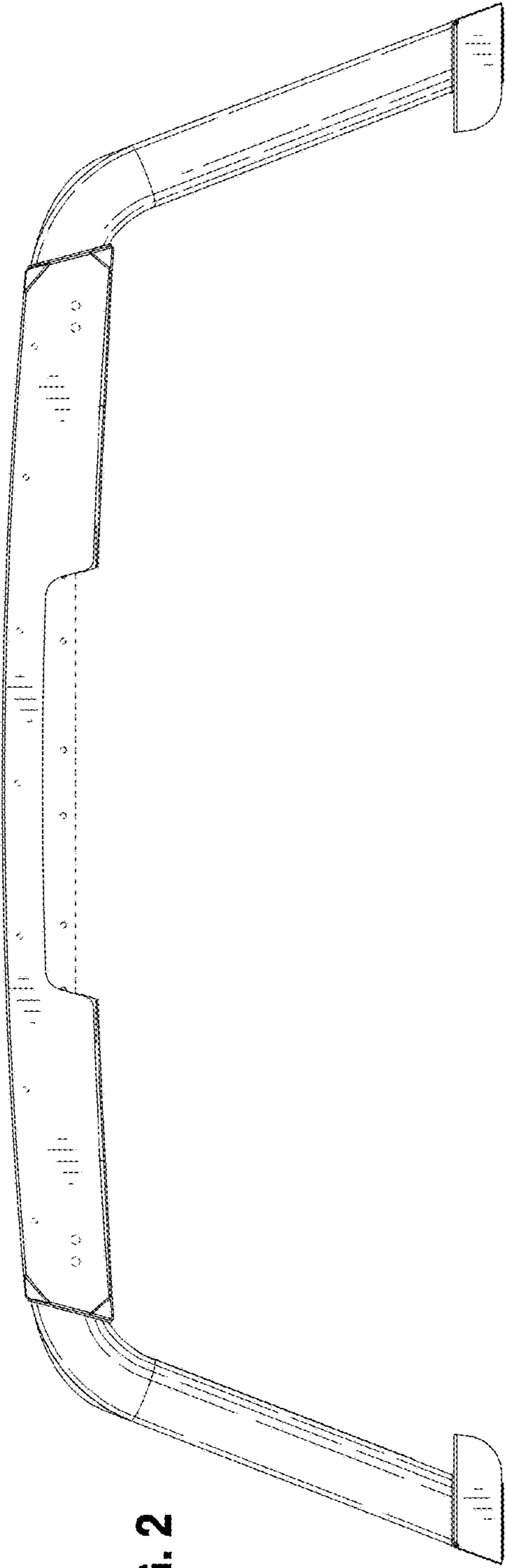

FIG. 2

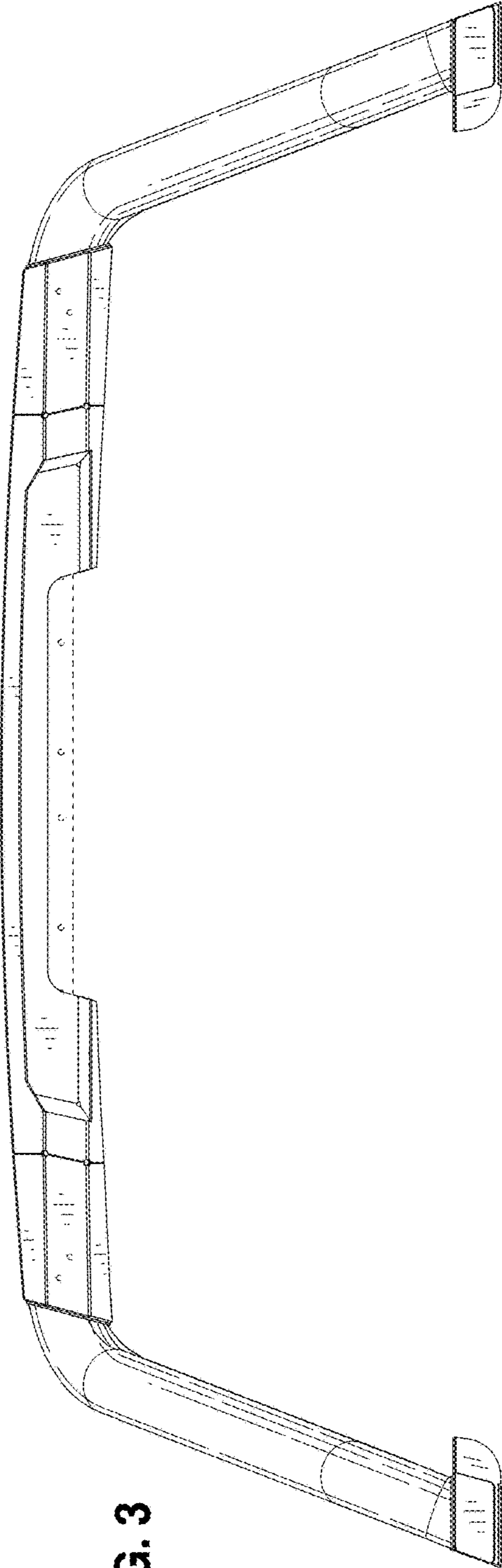

FIG. 3

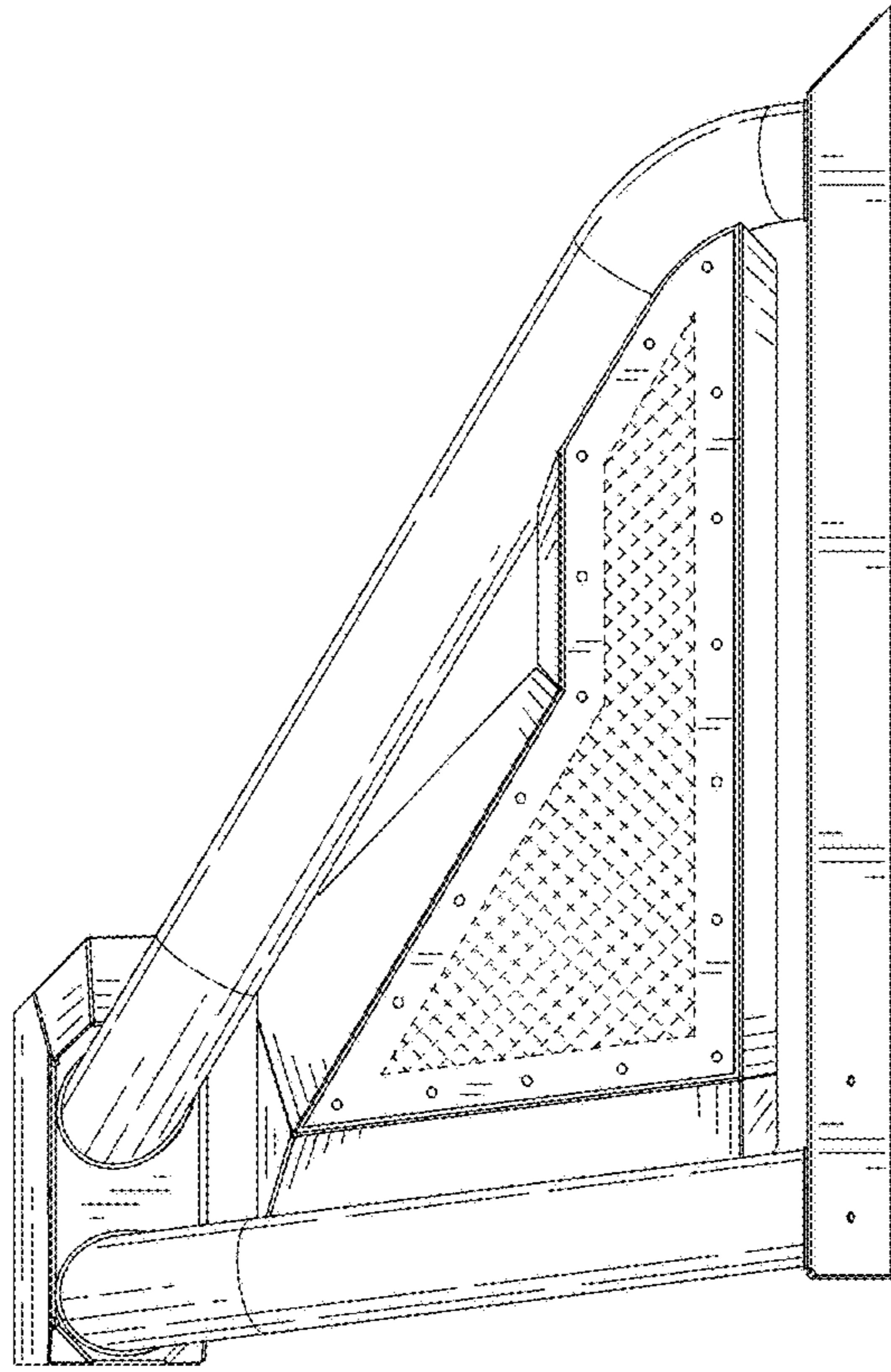

FIG. 5

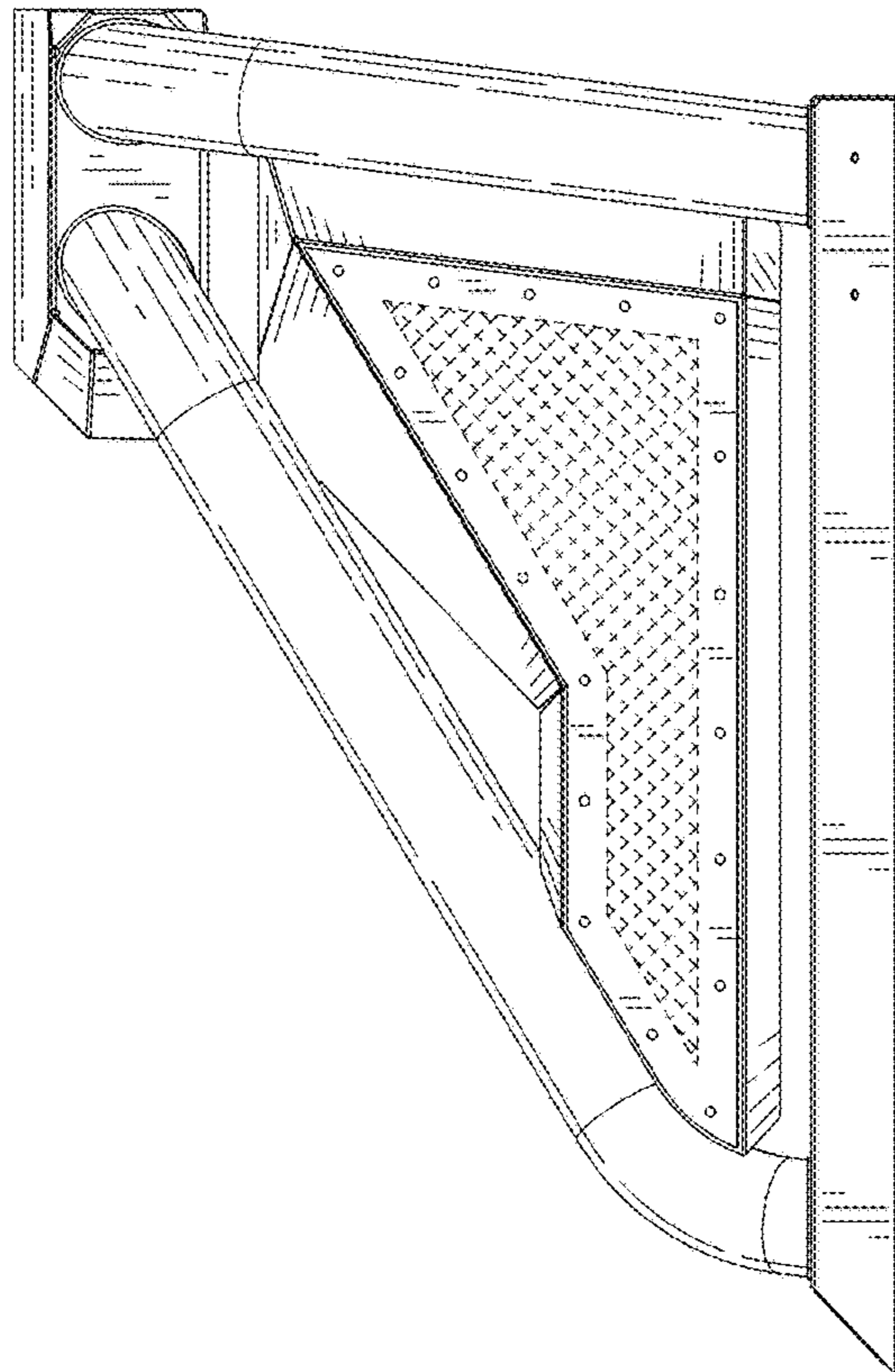

FIG. 4

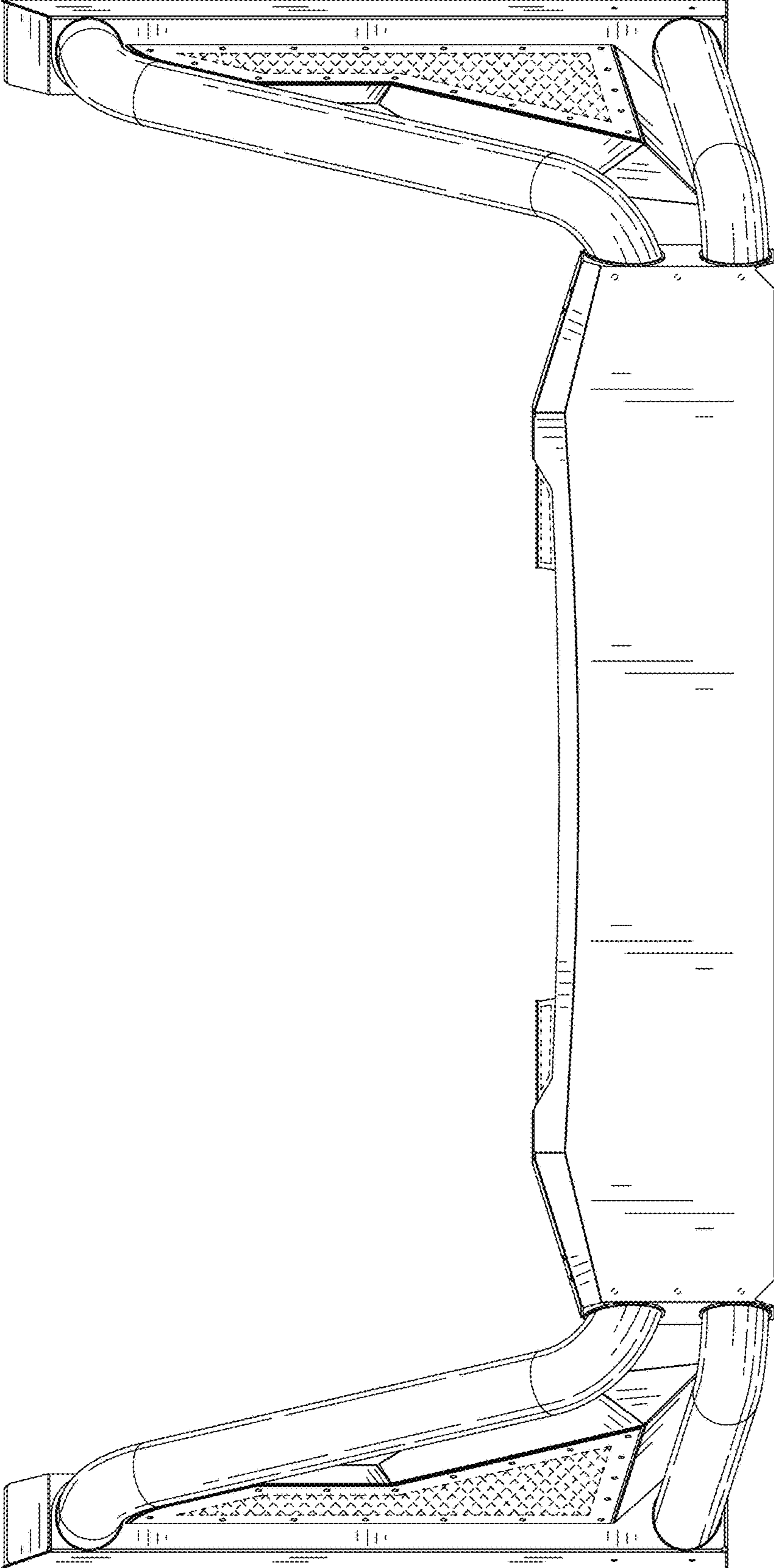

FIG. 6

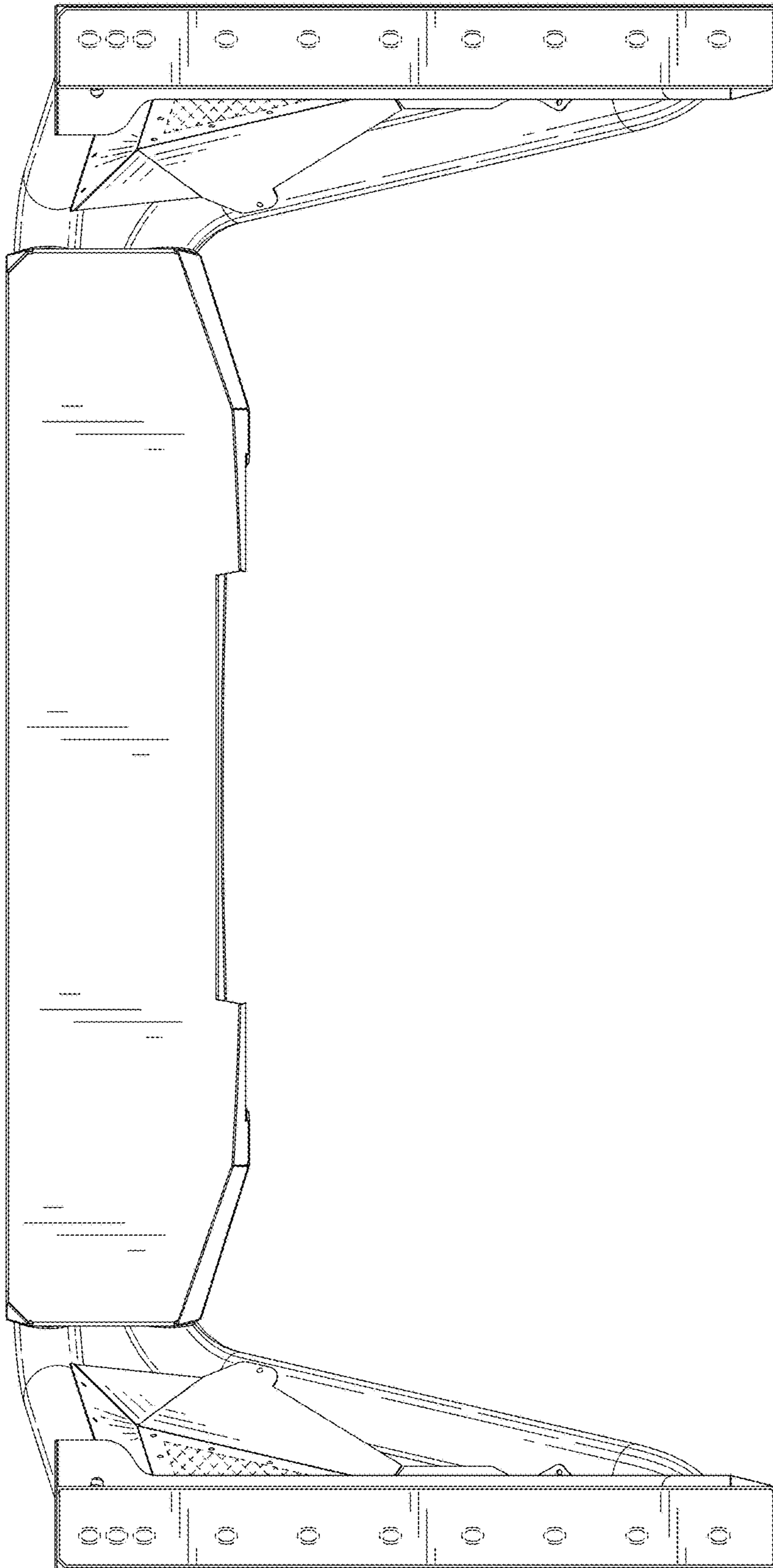

FIG. 7