



US00D845865S

(12) **United States Design Patent**
Zhao

(10) **Patent No.:** **US D845,865 S**

(45) **Date of Patent:** **** Apr. 16, 2019**

(54) **AUTOMOBILE WHEEL**

(71) Applicant: **WAH HUNG GROUP INC.**, Monterey Park, CA (US)

(72) Inventor: **John Zhao**, Monterey Park, CA (US)

(73) Assignee: **Wah Hung Group Inc.**, Monterey Park, CA (US)

(**) Term: **15 Years**

(21) Appl. No.: **29/623,959**

(22) Filed: **Oct. 27, 2017**

(51) **LOC (11) Cl.** **12-16**

(52) **U.S. Cl.**
USPC **D12/211**

(58) **Field of Classification Search**
USPC D12/204–213
CPC B60B 7/00; B60B 7/02; B60B 7/04; B60B 7/01; B60B 7/06; B60B 3/04; B60B 1/00; B60B 3/10; B60B 1/10; B60B 1/08; B60B 3/06; B60B 1/12; B60B 3/02
See application file for complete search history.

(56) **References Cited**

U.S. PATENT DOCUMENTS

D578,455 S	*	10/2008	Pfeiffer	D12/211
D616,801 S	*	6/2010	Zhao	D12/211
D617,718 S	*	6/2010	Zhao	D12/211
D622,201 S	*	8/2010	Zhao	D12/211
D680,486 S	*	4/2013	Zhao	D12/211
D683,687 S	*	6/2013	Alfonso	D12/211
D684,915 S	*	6/2013	Zhao	D12/211
D725,019 S	*	3/2015	Kim	D12/211
D749,031 S	*	2/2016	Zhao	D12/211

D756,881 S	*	5/2016	Zhao	D12/211
D770,961 S	*	11/2016	Chan	D12/213
D802,512 S	*	11/2017	Kong	D12/211
D811,305 S	*	2/2018	Hodges	D12/211
D821,281 S	*	6/2018	Zhao	D12/209

* cited by examiner

Primary Examiner — Stacia A Cadmus

(74) *Attorney, Agent, or Firm* — Payam Moradian

(57) **CLAIM**

I claim the ornamental design for an automobile wheel, as shown and described.

DESCRIPTION

FIG. 1 is a front elevational view of the automobile wheel; FIG. 2 is a perspective view thereof; FIG. 3 is a front elevational view of the automobile wheel, according to a second embodiment; FIG. 4 is a perspective view thereof; FIG. 5 is a front elevational view of the automobile wheel, according to a third embodiment; FIG. 6 is a perspective view thereof; FIG. 7 is a front elevational view of the automobile wheel, according to a fourth embodiment; FIG. 8 is a perspective view thereof; FIG. 9 is a front elevational view of the automobile wheel, according to a fifth embodiment; FIG. 10 is a perspective view thereof; FIG. 11 is a front elevational view of the automobile wheel, according to a sixth embodiment; and, FIG. 12 is a perspective view thereof. The broken lines in the drawings of the automobile wheel are for showing portions of the automobile wheel and form no part of the claimed design.

1 Claim, 12 Drawing Sheets

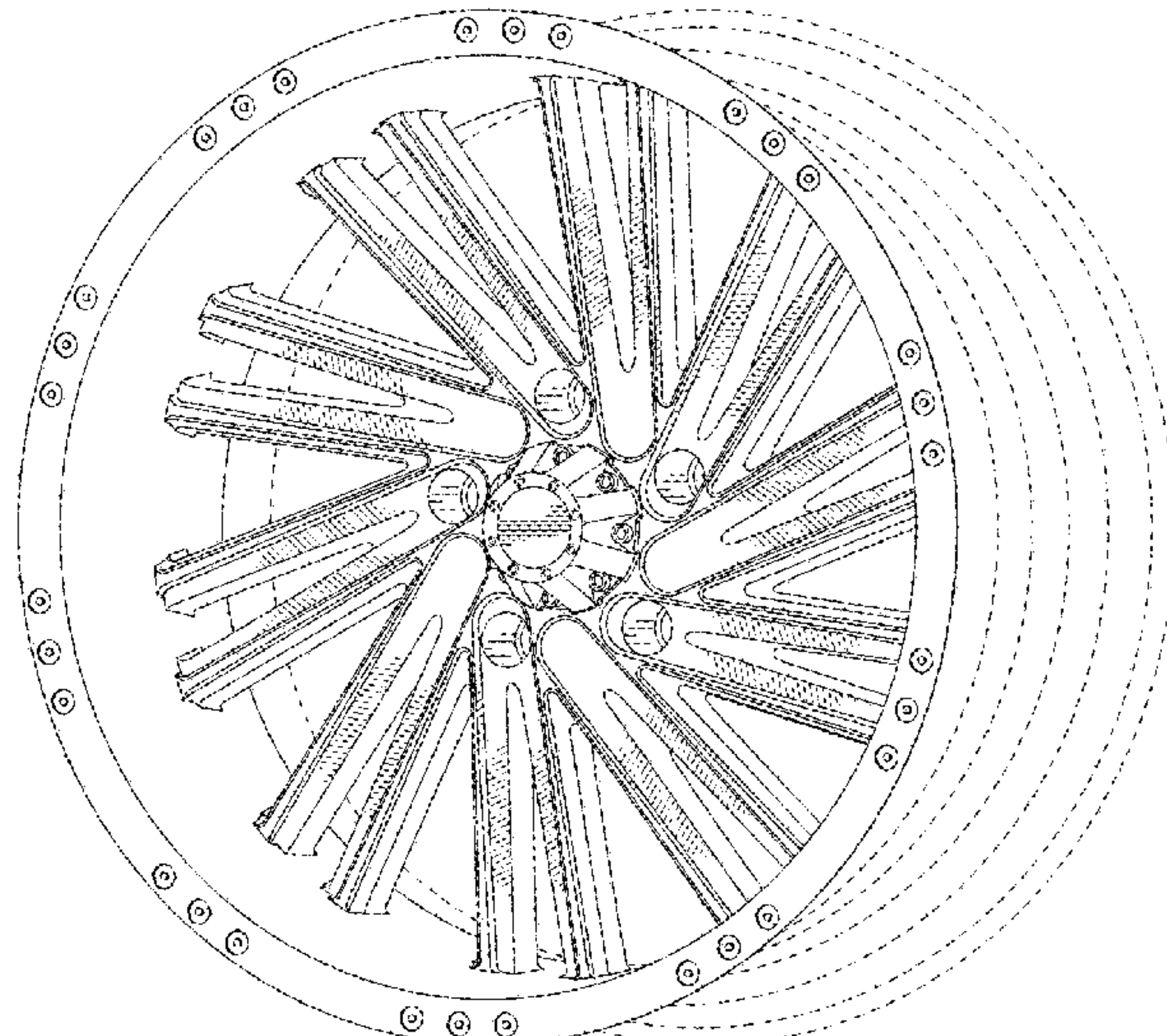
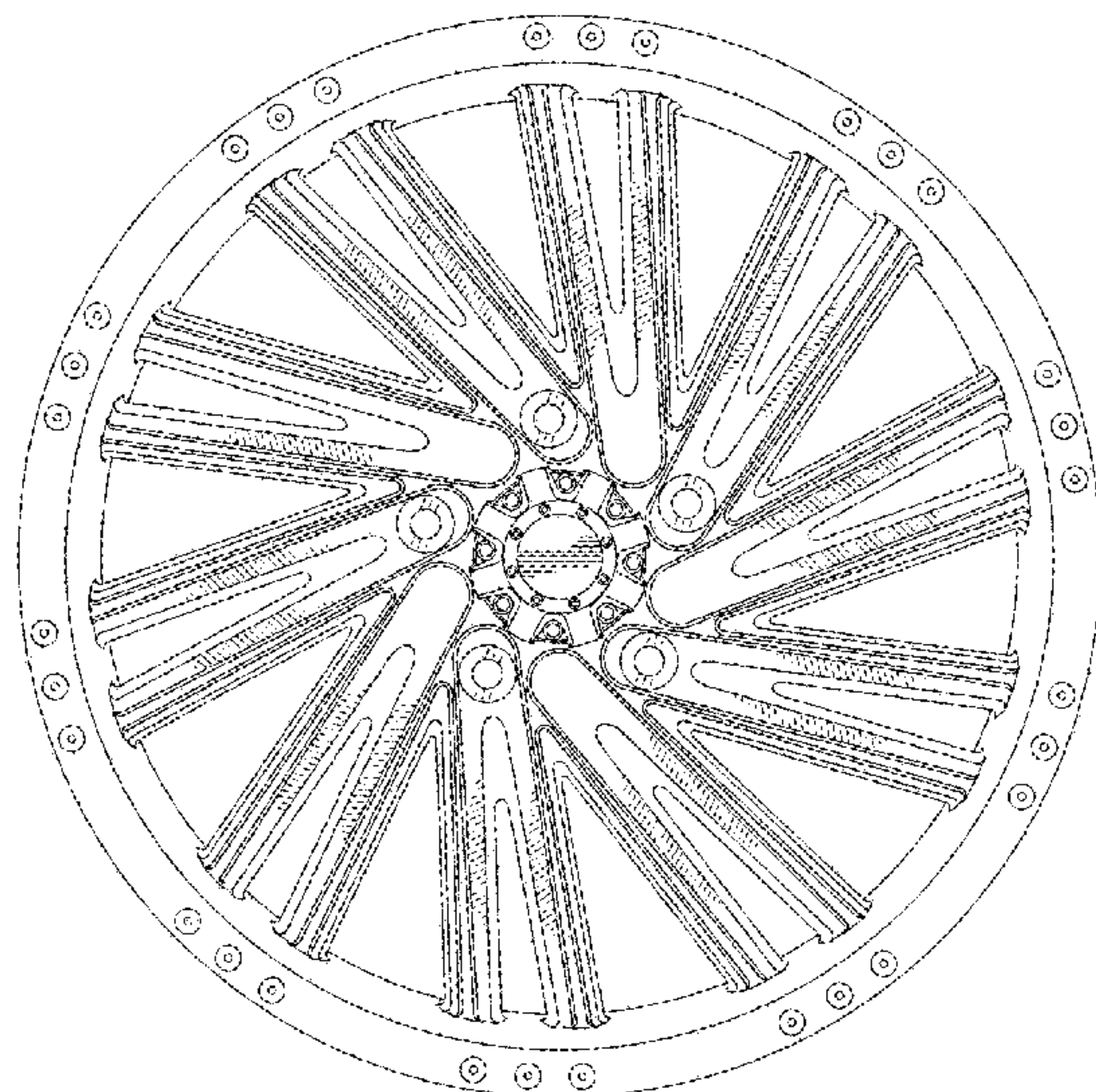

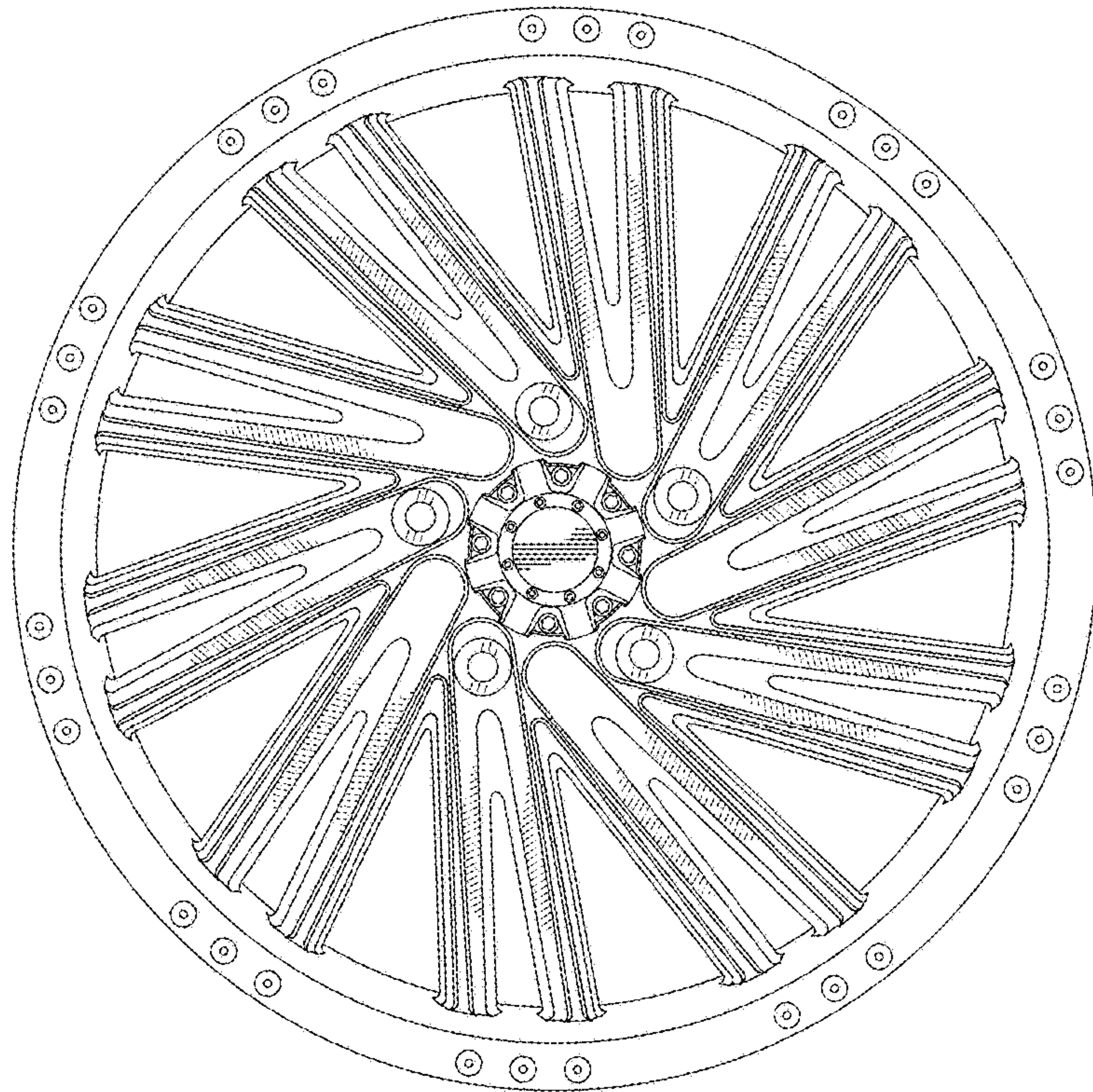

FIG. 1

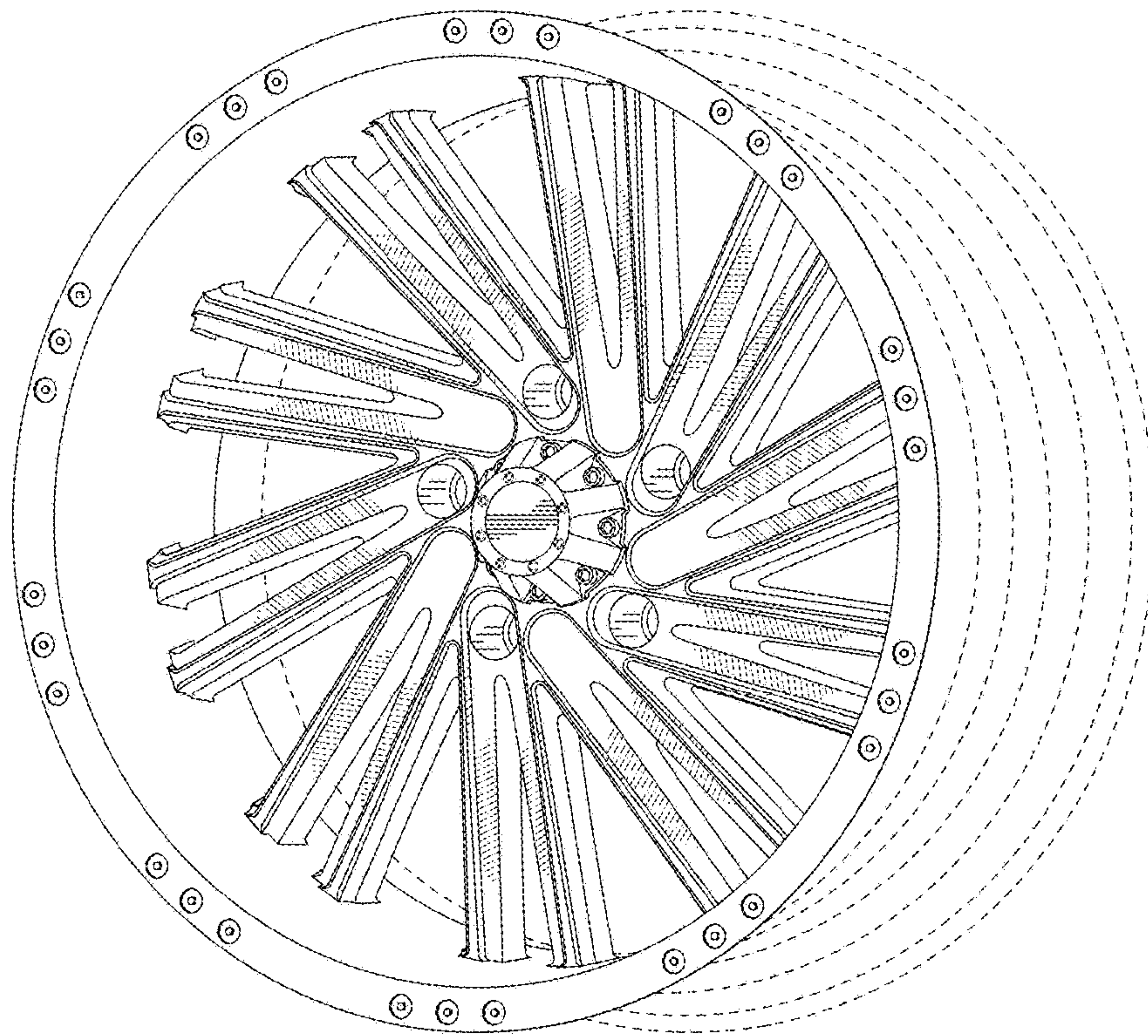

FIG.2

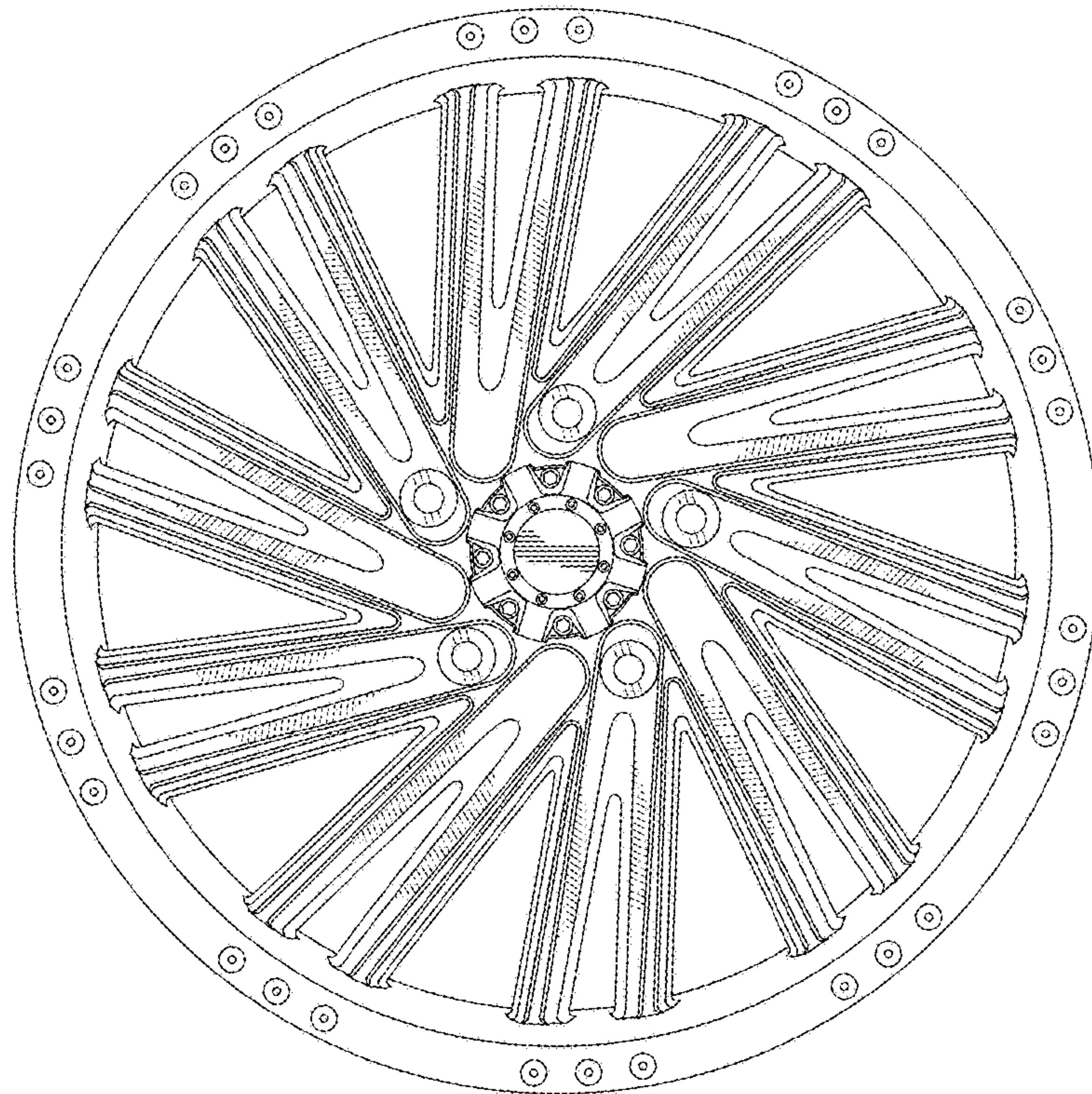

FIG.3

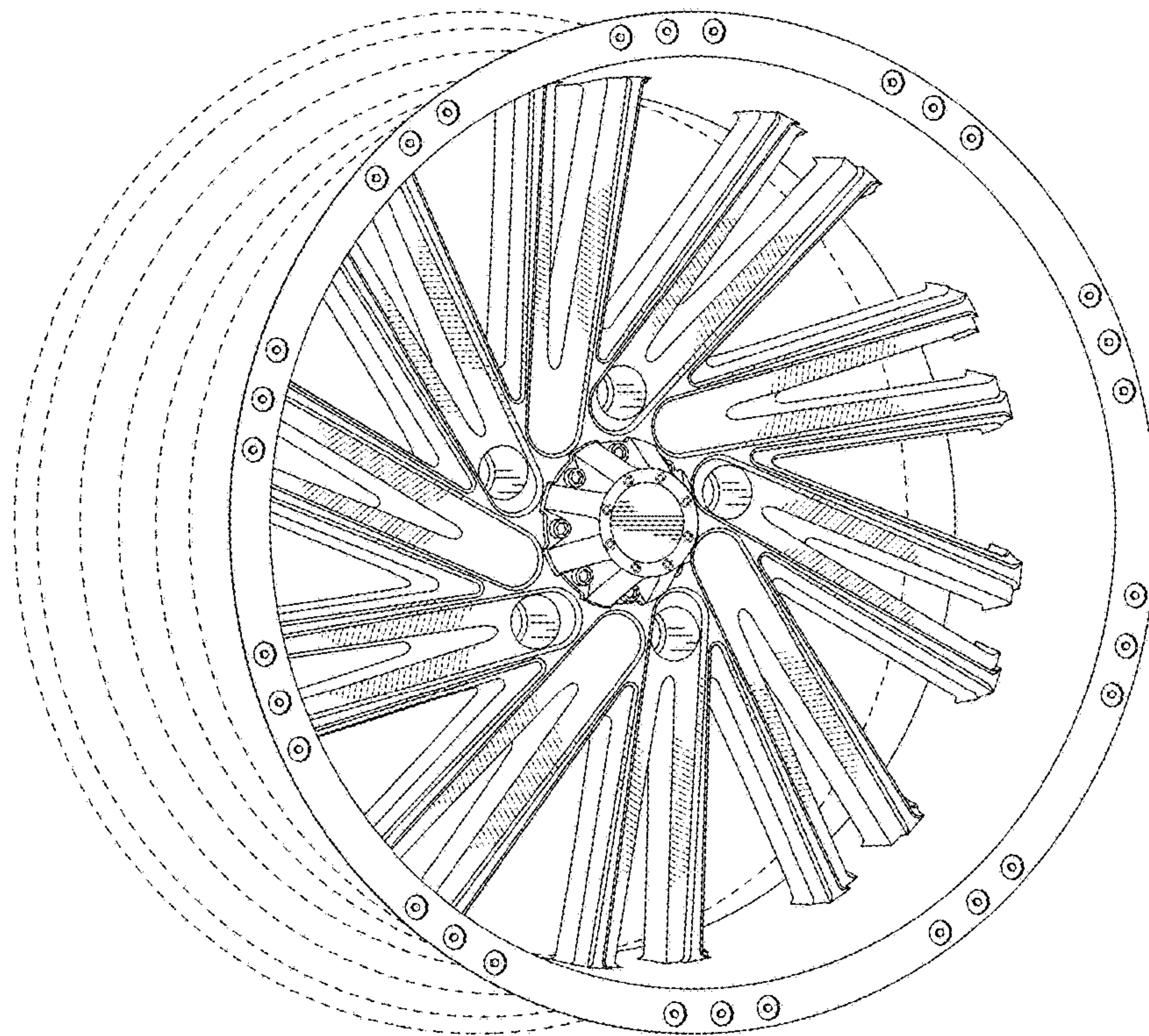

FIG.4

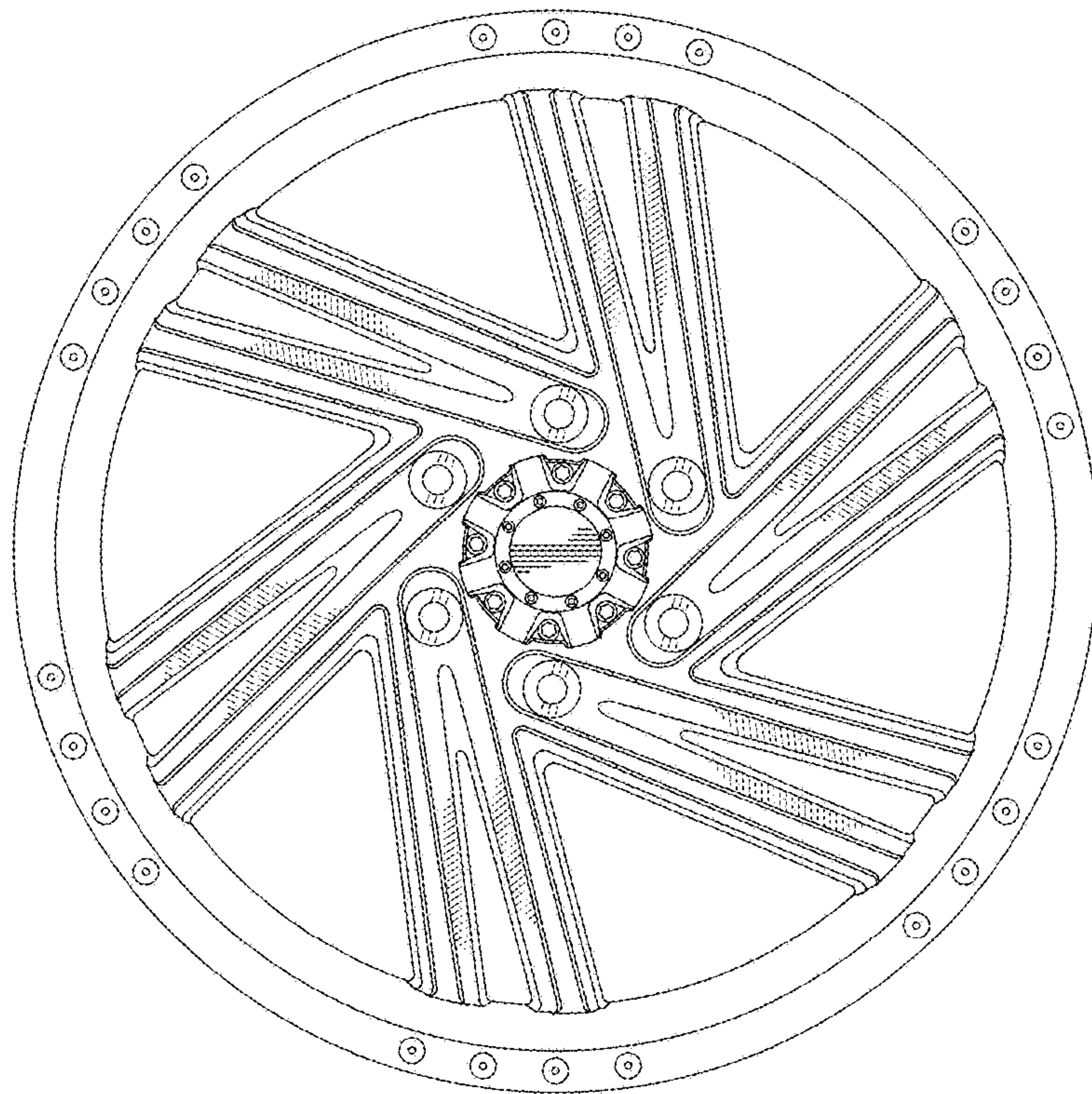

FIG.5

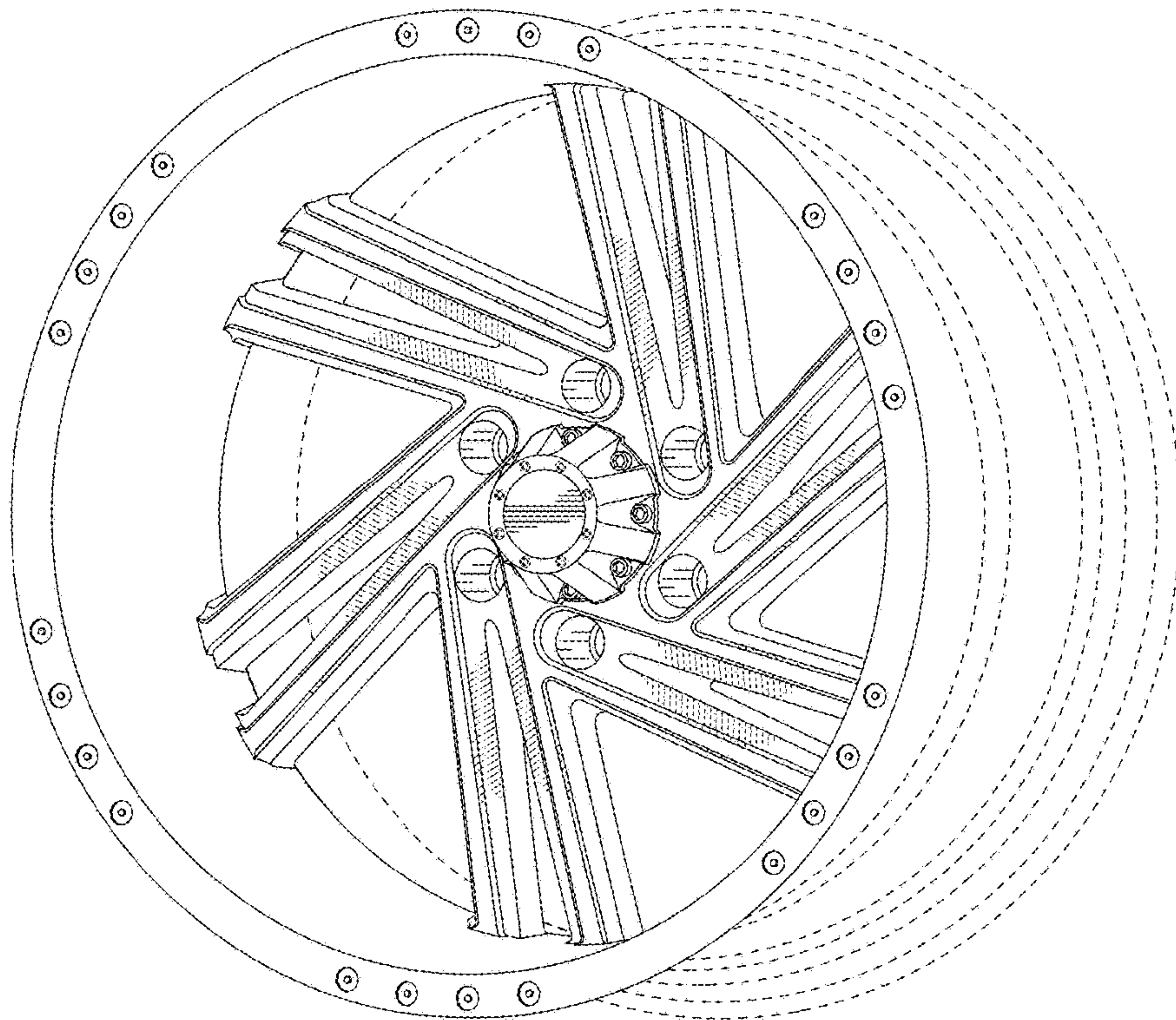

FIG.6

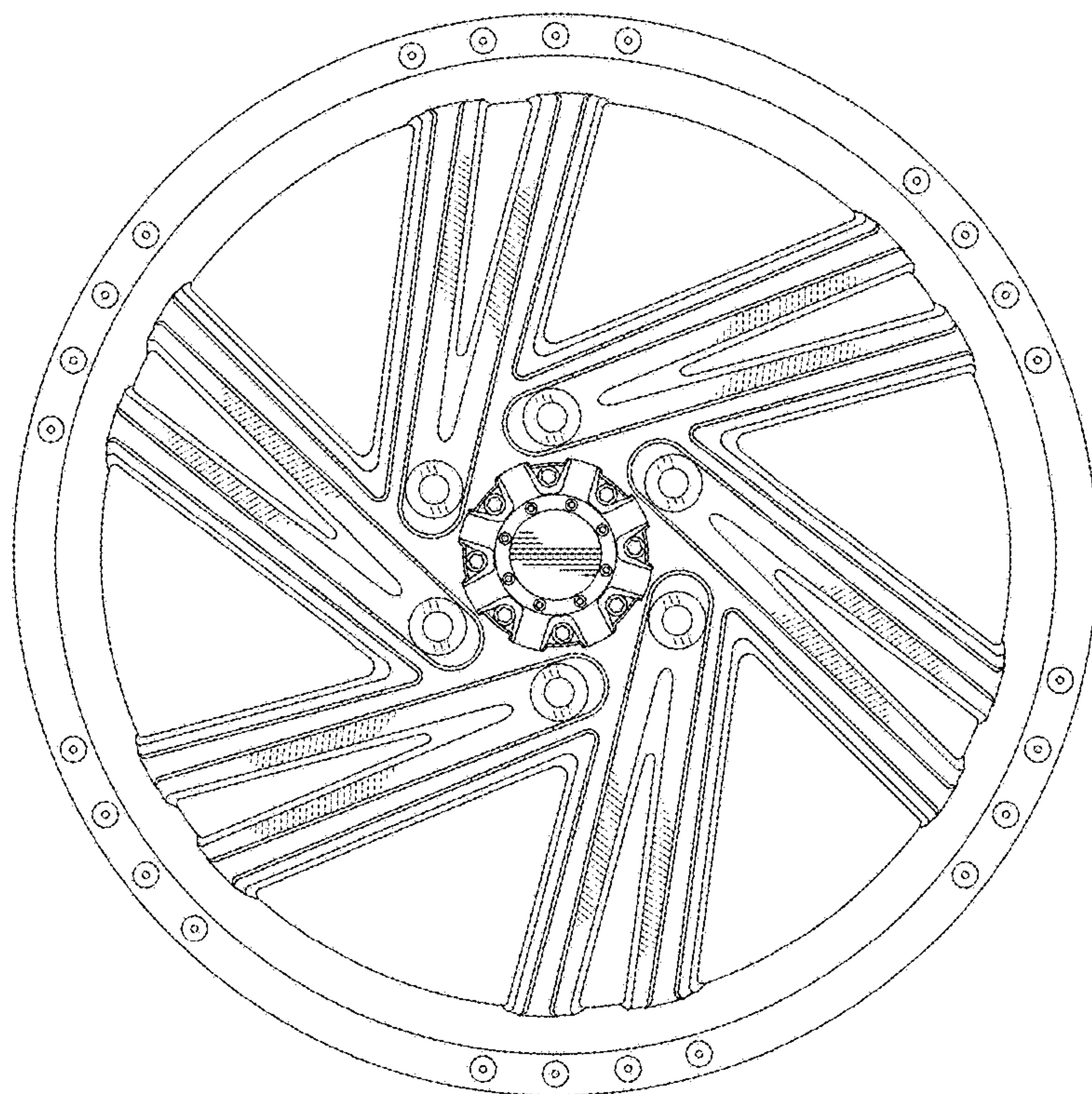

FIG.7

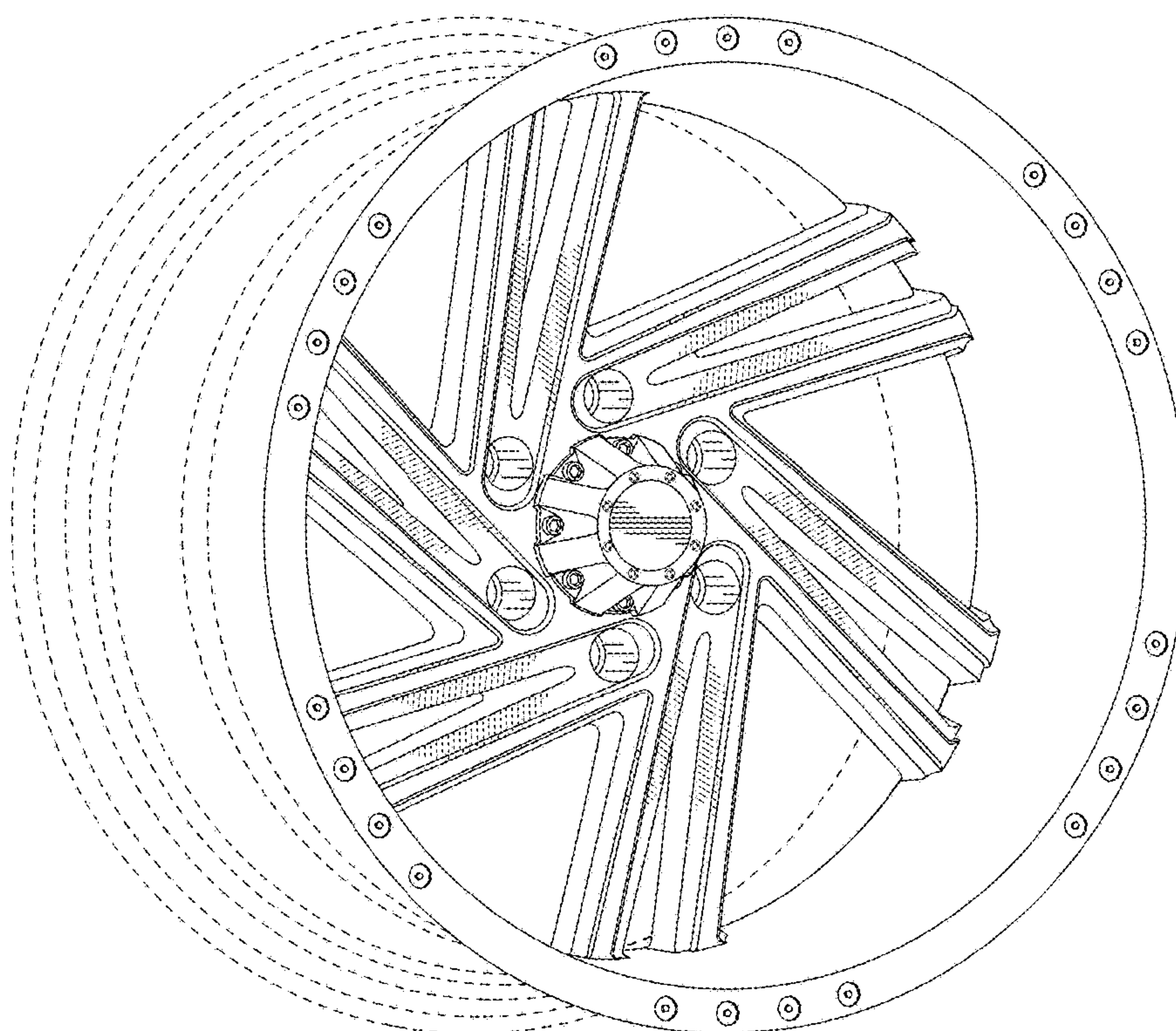

FIG. 8

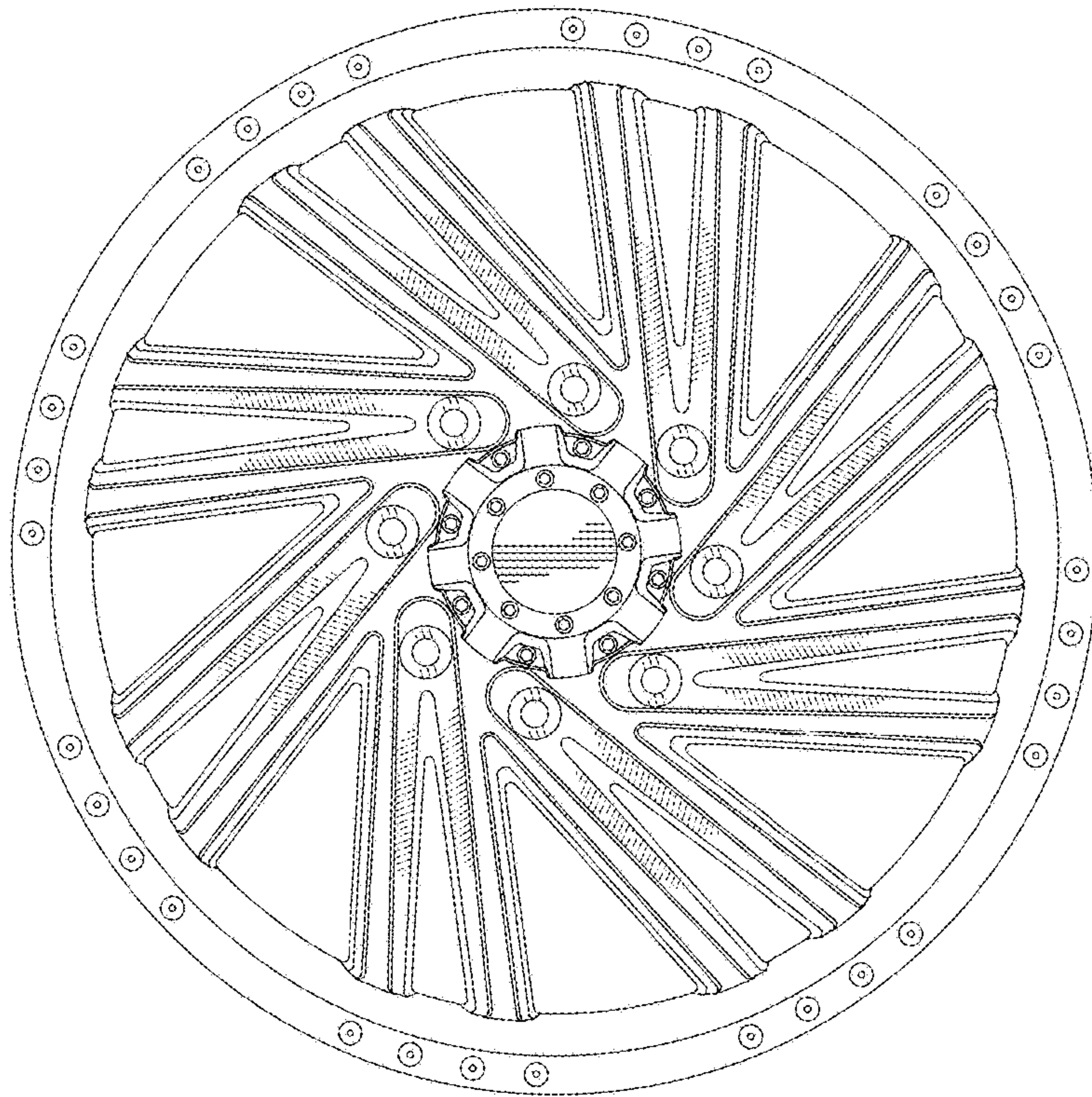

FIG.9

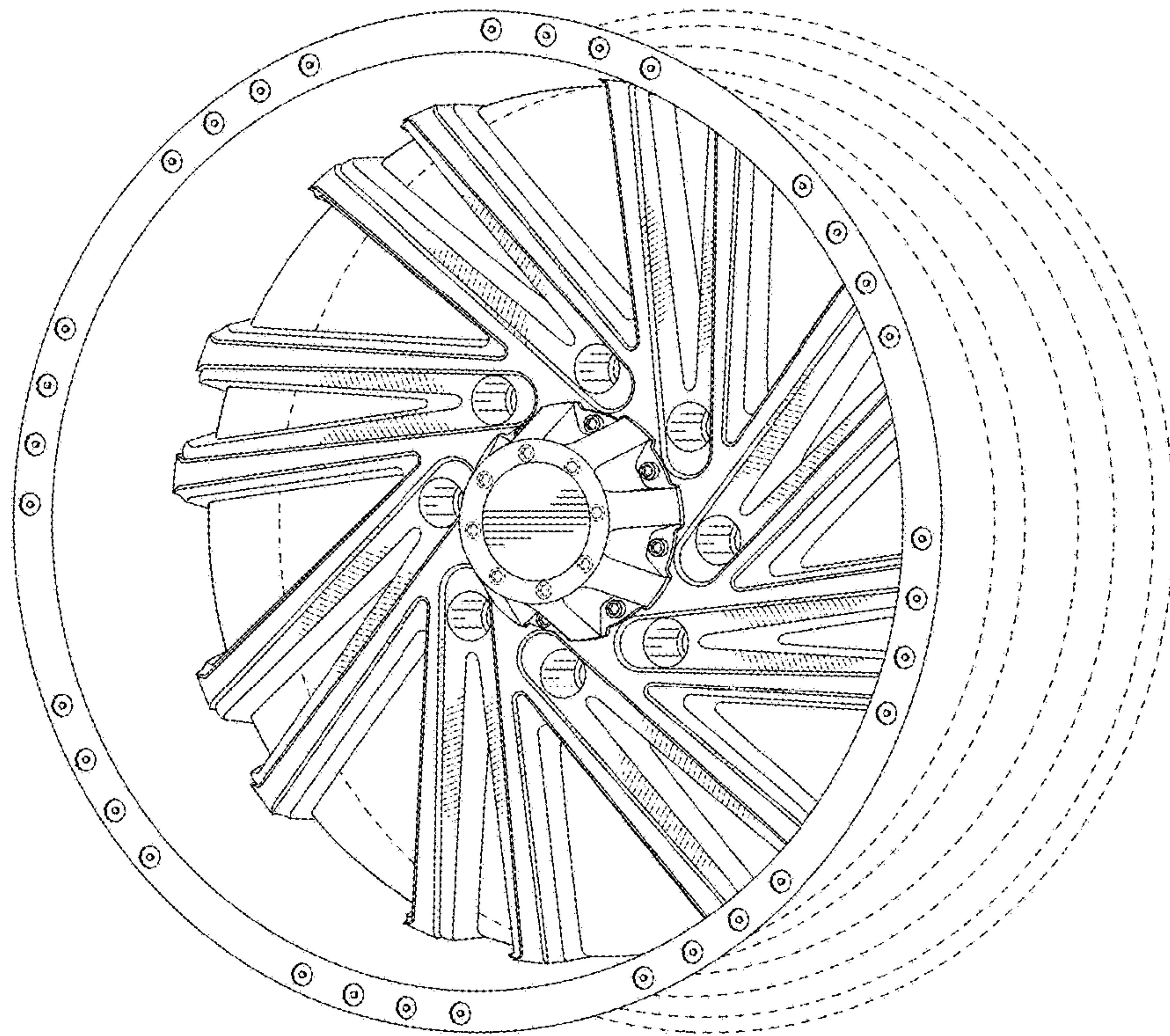

FIG.10

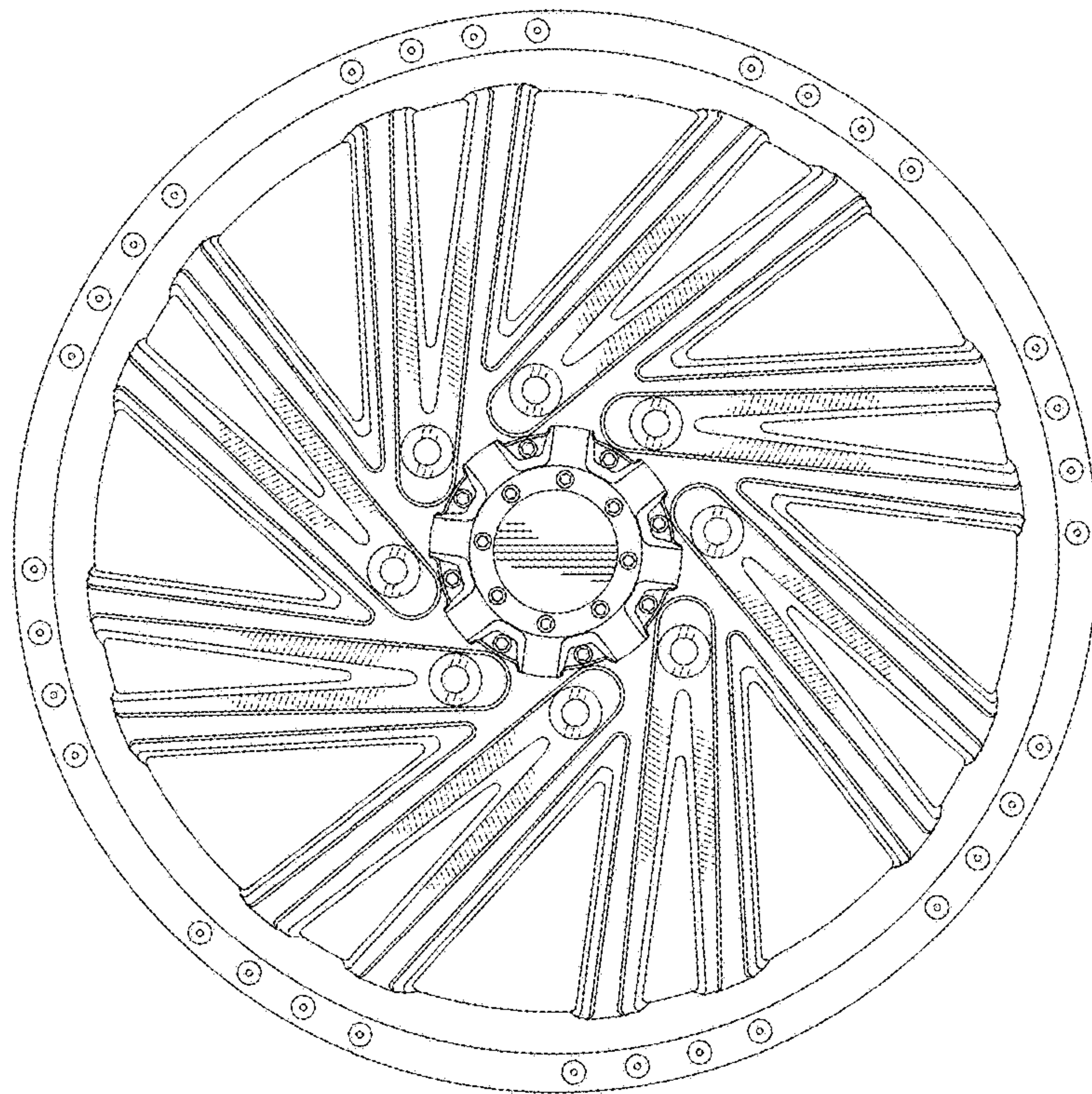

FIG.11

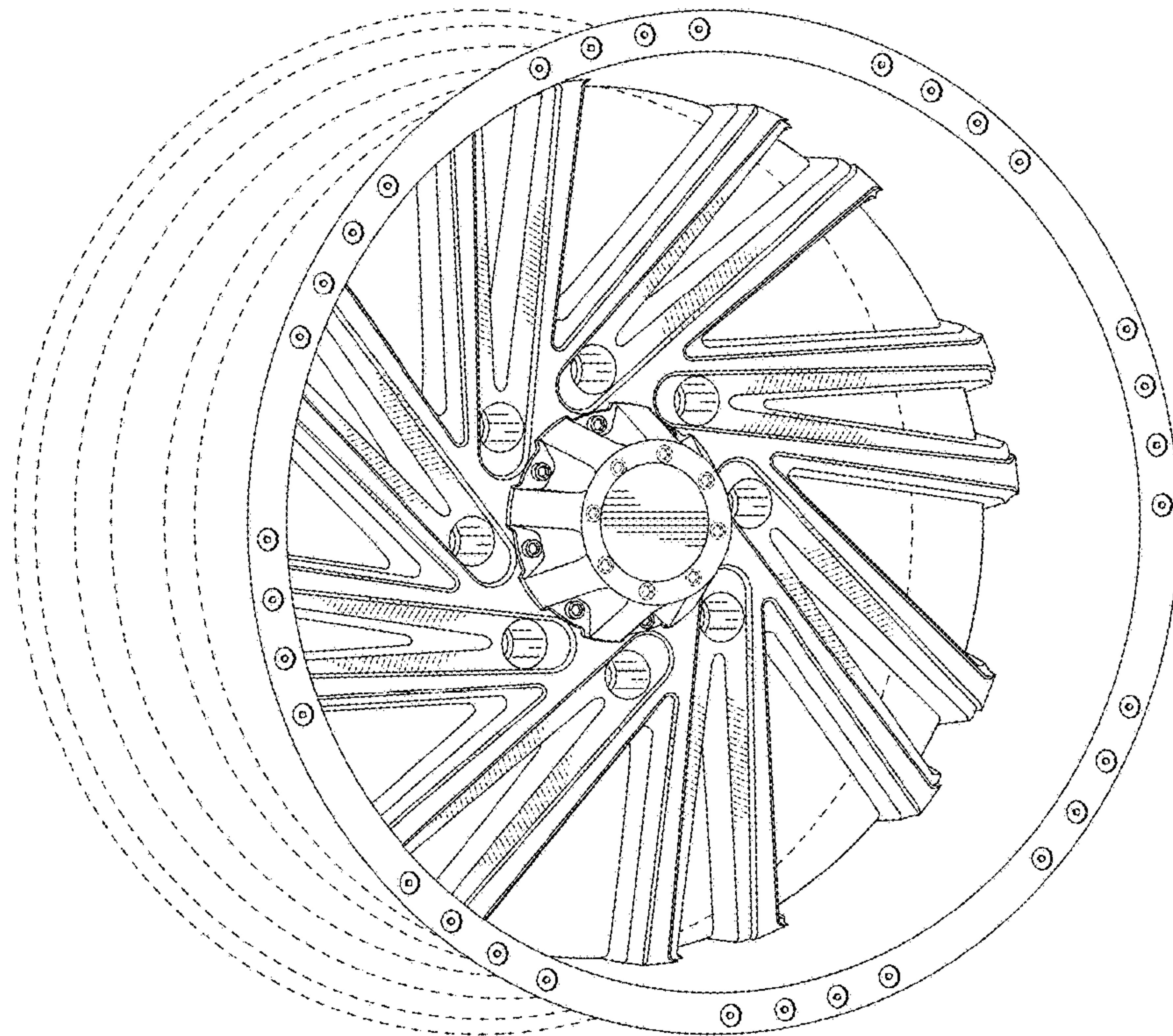

FIG.12