



US00D845782S

(12) **United States Design Patent** (10) **Patent No.:** **US D845,782 S**
Faillant-Dumas (45) **Date of Patent:** **** Apr. 16, 2019**

(54) **PERFUME BOTTLE** D783,410 S * 4/2017 Bertaux D9/690
 D795,699 S * 8/2017 Vivas D9/545
 (71) Applicant: **LVMH FRAGRANCE BRANDS,** D821,215 S * 6/2018 Sawicki D9/558
 Levallois-Perret (FR) D837,658 S * 1/2019 Cabaleiro D9/552

(72) Inventor: **Jérôme Faillant-Dumas**, Paris (FR)

* cited by examiner

(73) Assignee: **LVMH FRAGRANCE BRANDS,**
Levallois Perret (FR)

Primary Examiner — Michael A. Pratt

(**) Term: **15 Years**

(57) **CLAIM**

(21) Appl. No.: **35/504,564**

The ornamental design for a perfume bottle, as shown and described.

(22) Filed: **Feb. 9, 2018**

(80) **Hague Agreement Data**

Int. Filing Date: **Feb. 9, 2018**
 Int. Reg. No.: **DM/099922**
 Int. Reg. Date: **Feb. 9, 2018**
 Int. Reg. Pub. Date: **Mar. 9, 2018**

DESCRIPTION

(30) **Foreign Application Priority Data**

Aug. 17, 2017 (EM) 004151835-0001

(51) **LOC (11) Cl.** **09-01**

(52) **U.S. Cl.**
 USPC **D9/552**; D9/454; D9/545; D9/558

(58) **Field of Classification Search**
 USPC D9/552, 454, 545, 558
 CPC B65D 1/02; B65D 1/023; B65D 1/0276
 See application file for complete search history.

- 1. Perfume bottle
- 1.1 : Perspective
- 1.2 : Front
- 1.3 : Back
- 1.4 : Right
- 1.5 : Left
- 1.6 : Top
- 1.7 : Bottom

Bottle comprising a body and a cap; the body is cylindrical with a circular base; it has a bottom bulging inwards; it is surmounted by a central neck in the shape of a domed ring, with a narrowing between it and an upper shoulder of the body; the cap is cylindrical with a circular base, with a diameter approximately equal to that of the narrowing of the body.

(56) **References Cited**

U.S. PATENT DOCUMENTS

D357,632 S * 4/1995 Dinand D9/452
 D541,158 S * 4/2007 Herrmann D9/505
 D753,501 S * 4/2016 Komai D9/454
 D773,311 S * 12/2016 Park D9/453

1 Claim, 7 Drawing Sheets

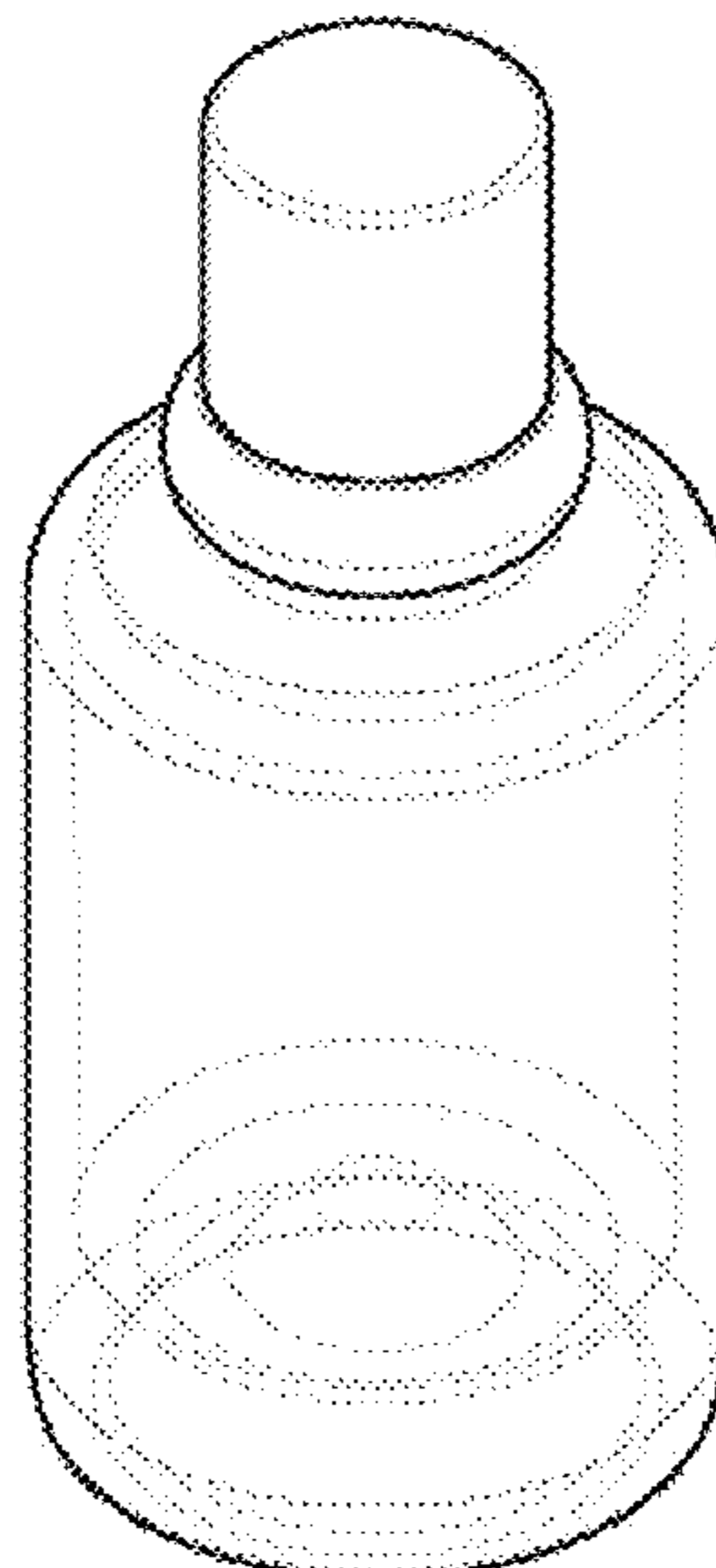

1.1

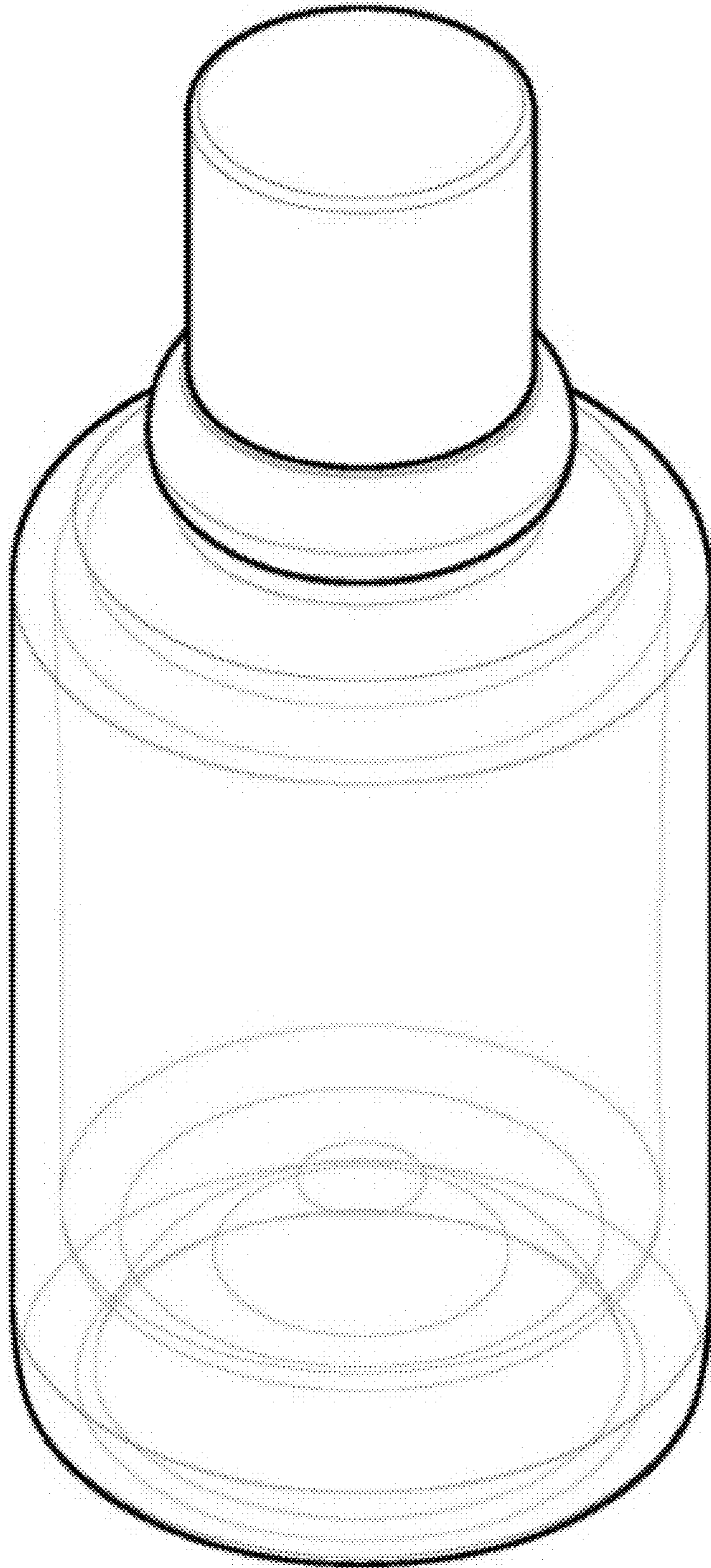

1.2

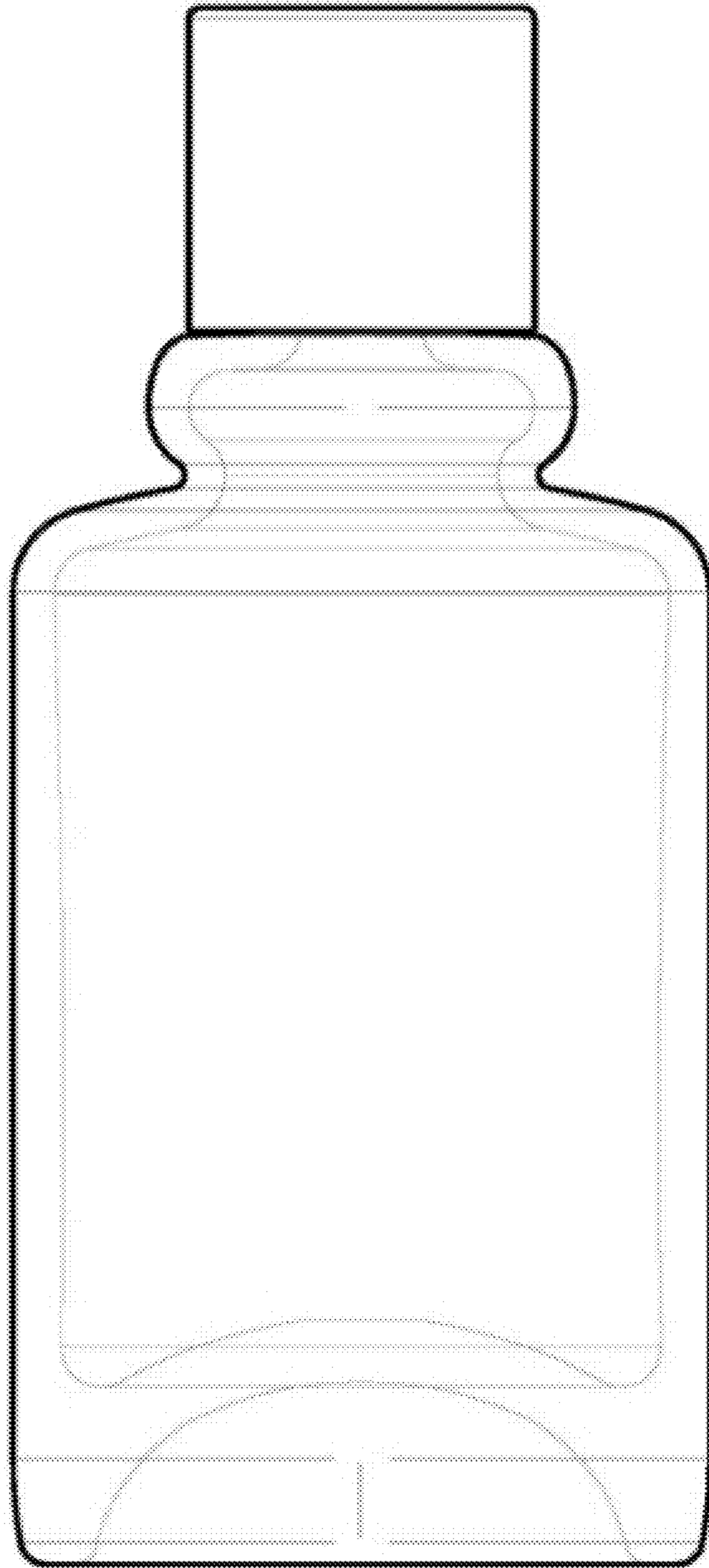

1.3

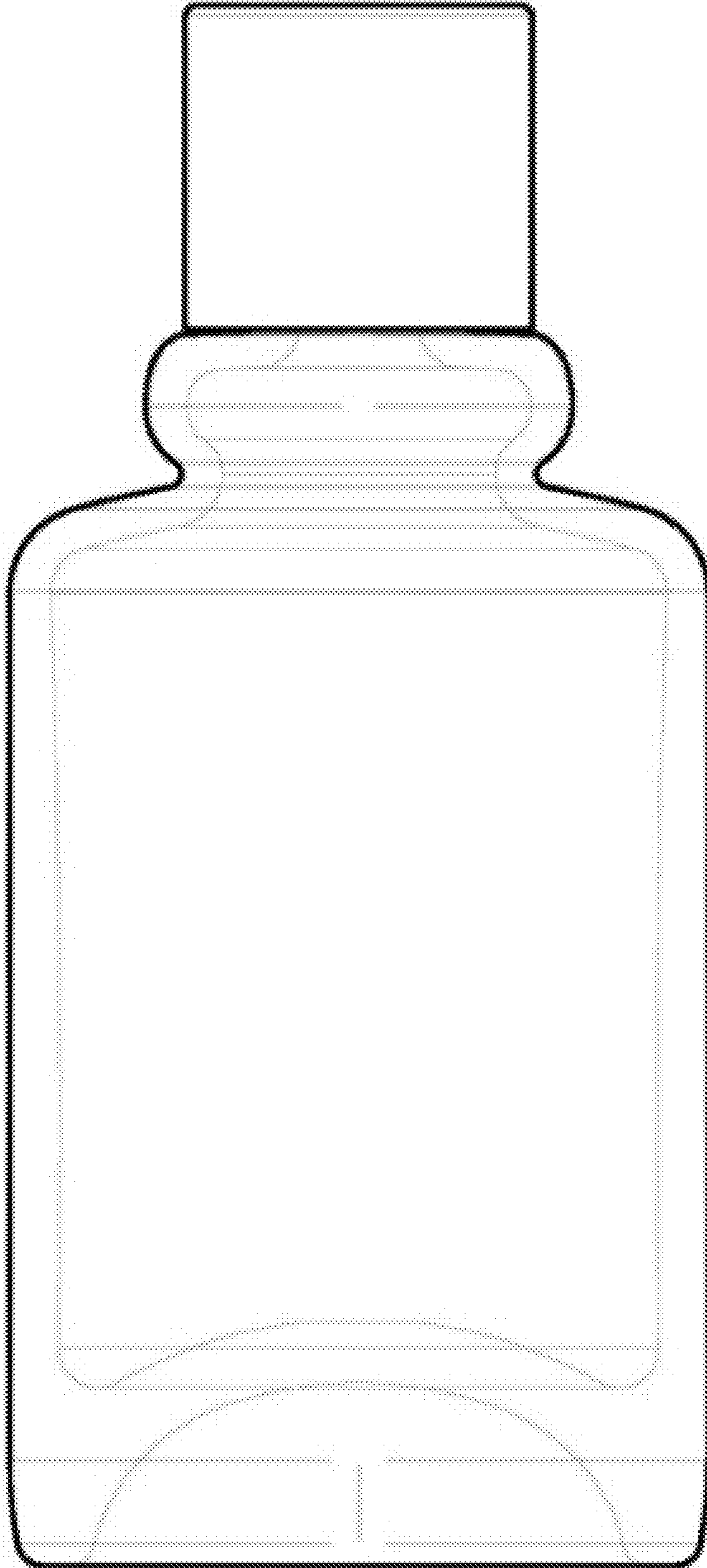

1.4

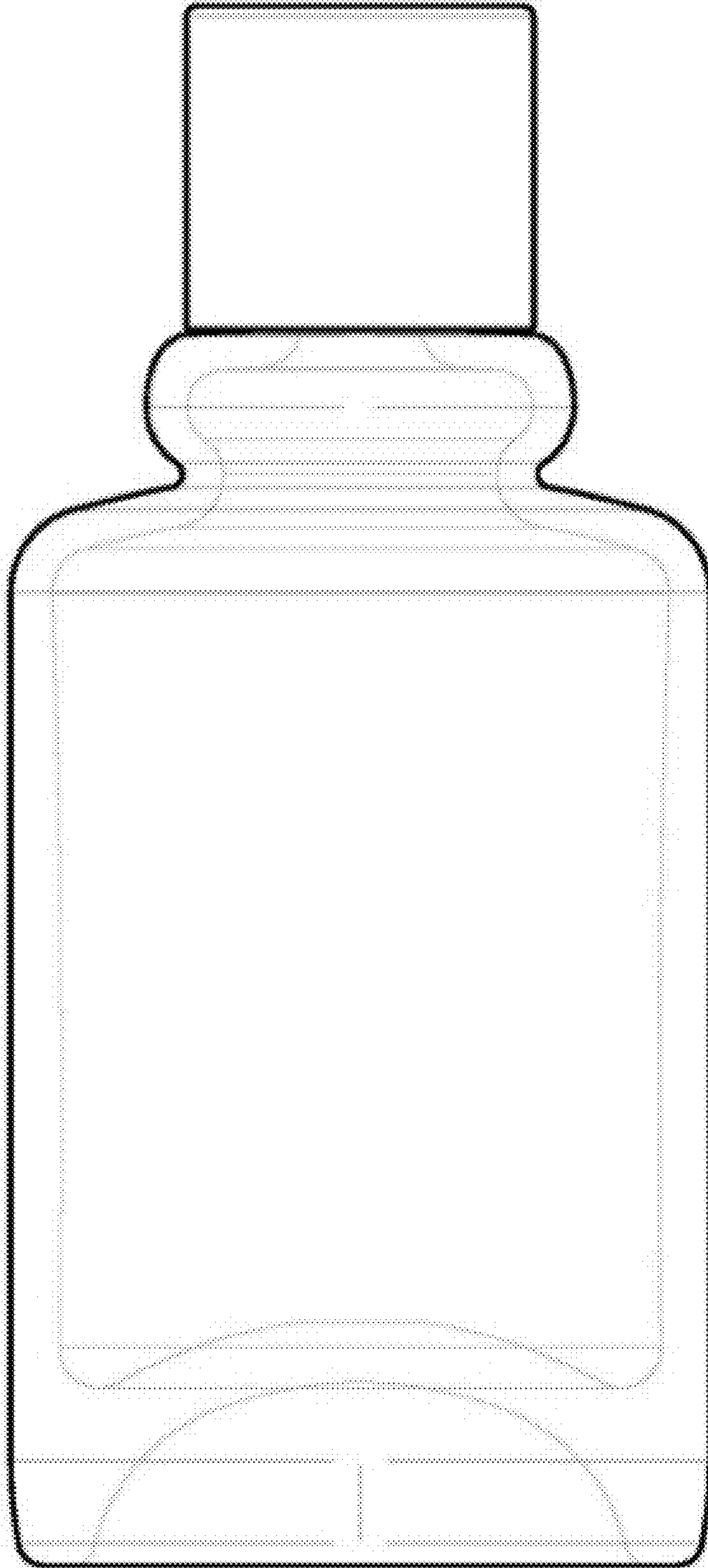

1.5

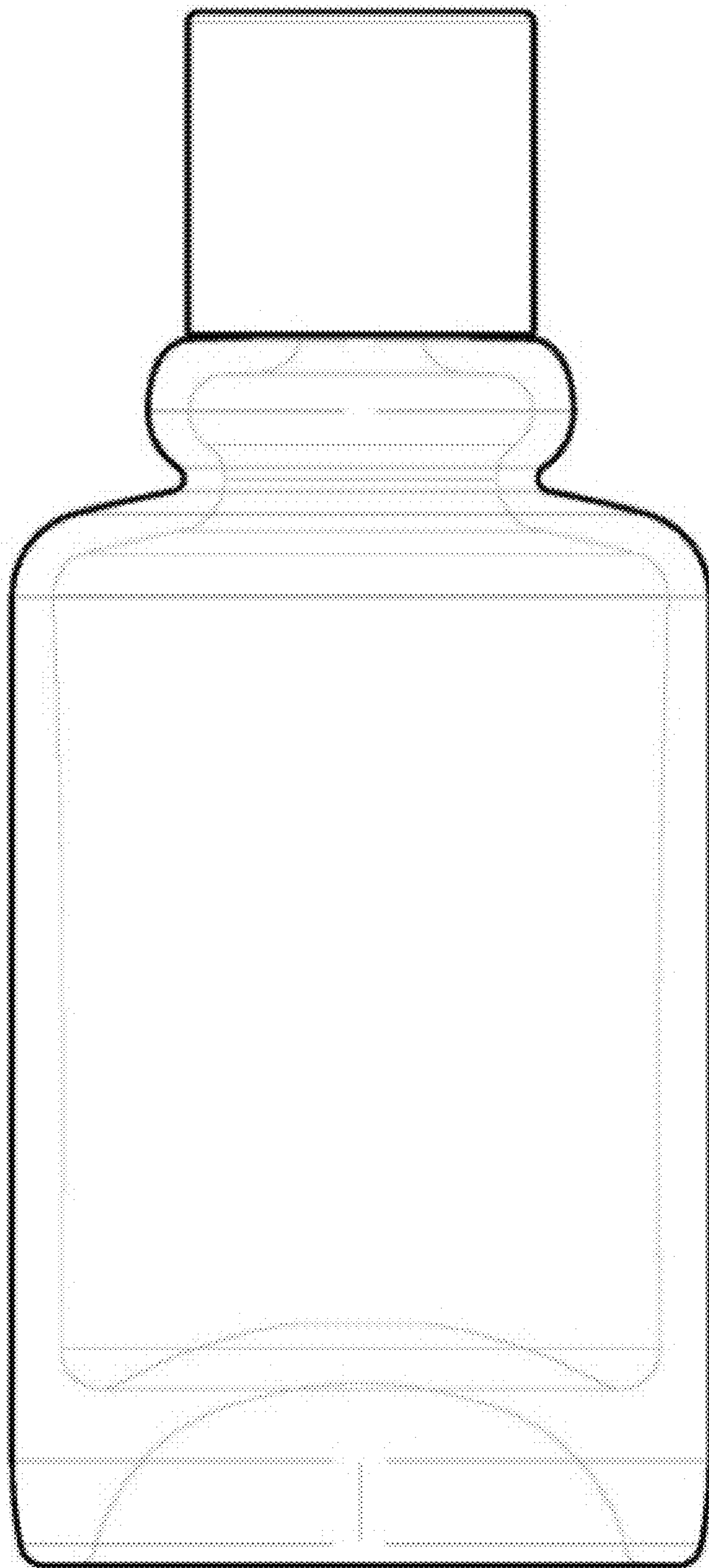

1.6

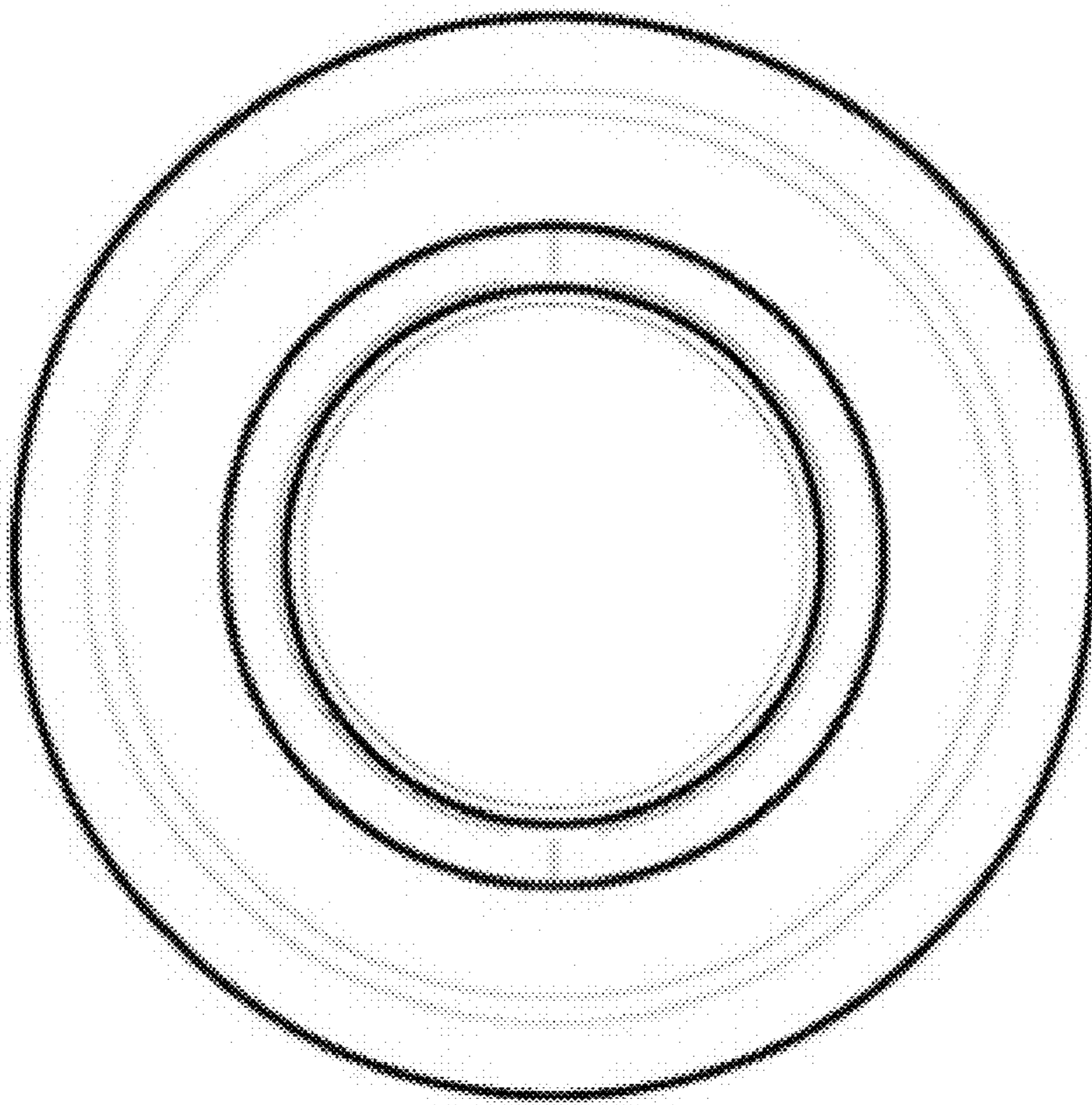

1.7

