



US00D845770S

(12) **United States Design Patent**
Berthe

(10) **Patent No.:** **US D845,770 S**

(45) **Date of Patent:** **** Apr. 16, 2019**

(54) **BOTTLE**

(71) Applicant: **ROCKWOOD & HINES GLASS GROUP CO. Ltd., Hong Kong (CN)**

(72) Inventor: **Henri Berthe, Shanghai (CN)**

(73) Assignee: **ROCKWOOD & HINES GLASS GROUP CO., Hong Kong (HK)**

(**) Term: **15 Years**

(21) Appl. No.: **29/590,379**

(22) Filed: **Jan. 10, 2017**

(51) **LOC (11) Cl.** **09-01**

(52) **U.S. Cl.**
USPC **D9/500**

(58) **Field of Classification Search**
USPC D9/500, 503, 505, 516, 520, 530, 537,
D9/539, 544-545, 549, 558, 715, 719;
D7/300, 598; D24/224
CPC B65D 1/00; B65D 1/02; B65D 1/0223;
B65D 23/00; B65D 81/00; B65D
2501/00; B65D 2501/0009
See application file for complete search history.

(56) **References Cited**

U.S. PATENT DOCUMENTS

342,540 A	5/1886	Salisbury	
959,772 A *	5/1910	Maney	A47B 73/00 211/74
D82,992 S	1/1931	Jones	
D59,583 S	11/1931	Green	
D117,266 S *	10/1939	Gerhart	D9/500
2,207,003 A	7/1940	Dunlap	
D124,880 S *	1/1941	Teunisz	229/4.5
2,267,246 A	12/1941	Meade	
D139,381 S	11/1944	Harris	
D181,056 S	9/1957	Jenkins	
D184,391 S *	2/1959	Du Pree	D9/520

D186,413 S	10/1959	Vuillemenot	
D189,374 S	11/1960	Harris	
D203,008 S *	11/1965	Ota	D28/91.1
D211,563 S	7/1968	Cherry	
D213,690 S	4/1969	Eckstrom	
D223,437 S	4/1972	Lluch	
D231,685 S	5/1974	Beckman	
D237,926 S	12/1975	Katzander	
4,148,619 A	4/1979	Deutsch	
D264,937 S *	6/1982	Groark	D9/500
4,971,276 A	11/1990	Tannenbaum	
D332,050 S	12/1992	Schmidt	
D335,084 S	4/1993	Snyder	

(Continued)

OTHER PUBLICATIONS

“Virus Vodka”, Texas Wine Lover, published Jun. 26, 2015, 7pages,
< <https://txwinelover.com/2015/06/virus-vodka/> >.*

(Continued)

Primary Examiner — Dana Meyrow
(74) *Attorney, Agent, or Firm* — Dawsey Co., LPA;
David J. Dawsey

(57) **CLAIM**

The ornamental design for a bottle, as shown and described.

DESCRIPTION

FIG. 1 is a perspective view of a bottle showing our new design;
FIG. 2 is a front elevation view thereof;
FIG. 3 is a rear elevation view thereof;
FIG. 4 is a right side elevation view thereof;
FIG. 5 is a left side elevation view thereof;
FIG. 6 is a top plan view thereof; and,
FIG. 7 is a bottom plan view thereof.
The drawings are lined for to represent a copper color. The broken lines show unclaimed subject matter only and form no part of the claimed design.

1 Claim, 4 Drawing Sheets

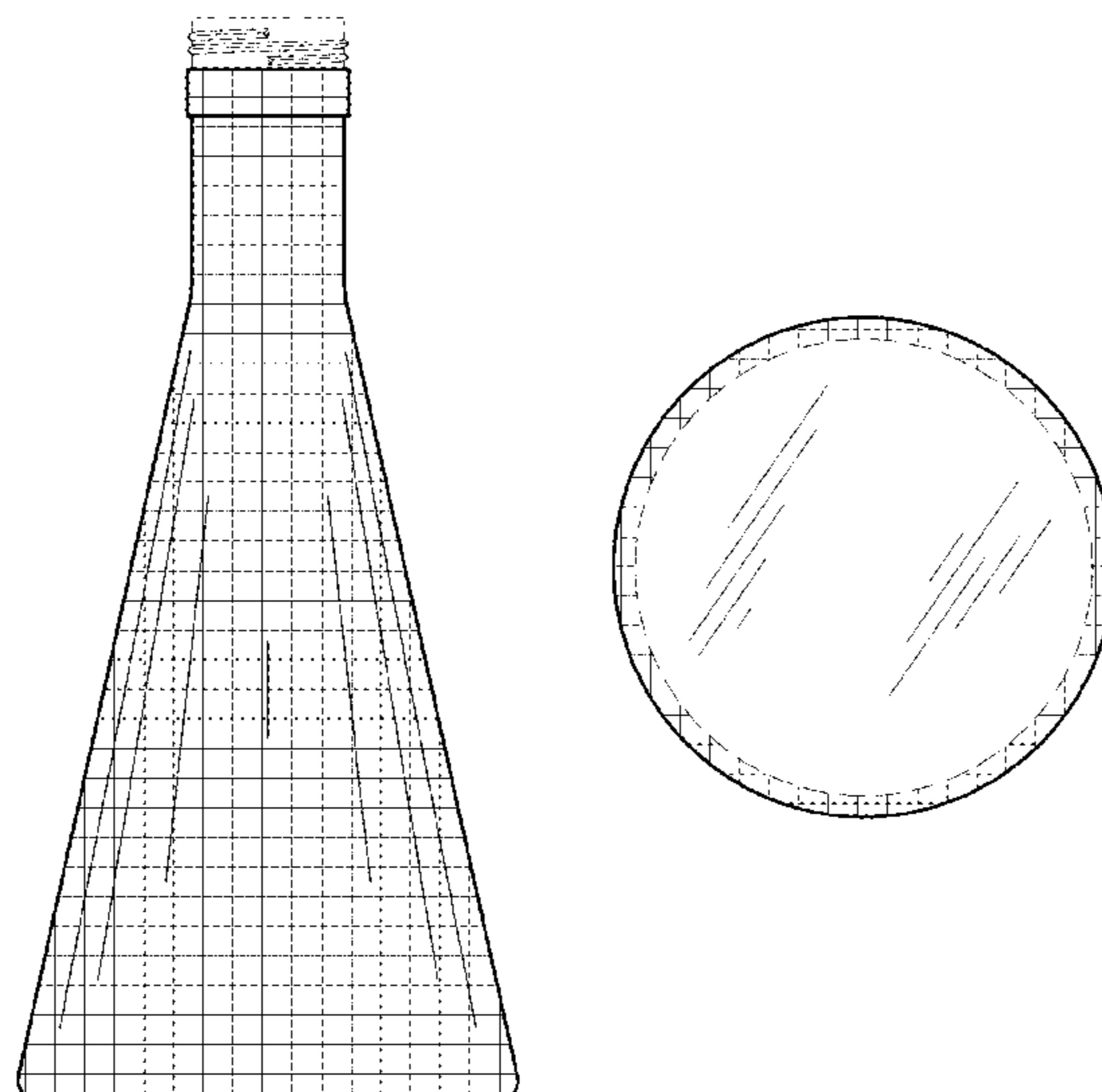

(56)

References Cited

U.S. PATENT DOCUMENTS

D342,680 S 12/1993 Pereira et al.
 D356,736 S 3/1995 Armstrong
 D358,985 S 6/1995 Rubin
 D359,688 S * 6/1995 Rosen D9/452
 D386,412 S 11/1997 Heinz
 D390,467 S 2/1998 Blackburn
 D392,565 S 3/1998 Blackburn
 D414,811 S 10/1999 Base et al.
 D419,719 S 1/2000 Garcia
 D444,700 S 7/2001 Ebert
 D463,262 S 9/2002 Gobe
 D464,265 S 10/2002 Elliot et al.
 D472,147 S 3/2003 Herrmann
 D474,406 S 5/2003 Kaposi
 D481,949 S 11/2003 Pinnavaia
 D483,264 S * 12/2003 Canepa D9/500
 D484,055 S 12/2003 Feigenbaum
 D485,885 S * 1/2004 Bonelli D23/207
 D522,369 S * 6/2006 Penn D9/520
 D530,968 S 10/2006 Bodum
 D542,135 S 5/2007 Machmadow
 D543,459 S * 5/2007 Konieczny D9/439
 D550,080 S 9/2007 Rica
 D551,557 S 9/2007 Osgerby et al.
 D555,416 S 11/2007 Bodum
 D555,496 S 11/2007 Osgerby et al.
 D568,151 S 5/2008 Moffat et al.
 D568,168 S 5/2008 Boukobza
 D569,264 S 5/2008 Yamanaka
 D573,833 S 7/2008 Bodum
 D577,126 S * 9/2008 Woeste D24/224
 D580,696 S 11/2008 Bodum
 D580,697 S 11/2008 Bodum
 D592,062 S 5/2009 DaSilva et al.
 D605,747 S 12/2009 Butler et al.
 D609,571 S 2/2010 Butler et al.
 D611,825 S 3/2010 Usui et al.
 D613,174 S 4/2010 Pecora
 D614,032 S 4/2010 Handy
 D615,404 S 5/2010 Pitzer et al.
 D616,261 S 5/2010 Lundstrom
 D616,262 S 5/2010 Lundstrom
 D618,563 S 6/2010 Ziegler
 D620,742 S 8/2010 Lion et al.
 D620,807 S 8/2010 Wang Treadway et al.
 D621,648 S 8/2010 Lown et al.
 D632,222 S 2/2011 Bischoff et al.
 D635,032 S 3/2011 Daniele
 D635,463 S 4/2011 Passi
 D640,084 S 6/2011 Sheppard et al.
 D640,091 S 6/2011 Sheppard et al.
 D642,469 S * 8/2011 Lauret D9/500
 D642,852 S 8/2011 Sheppard et al.
 D646,920 S 10/2011 Sheppard et al.

D652,319 S 1/2012 Cohen et al.
 D653,123 S 1/2012 Ziegler
 D654,794 S 2/2012 Morais et al.
 D654,795 S 2/2012 Handy
 D656,840 S 4/2012 Tacconi et al.
 D661,939 S 6/2012 Kern et al.
 D663,618 S 7/2012 Cohen et al.
 D666,101 S 8/2012 Handy
 D671,409 S 11/2012 Cohen et al.
 D673,342 S 12/2012 Kline et al.
 D701,462 S 3/2014 Lee
 D702,130 S 4/2014 Handy
 D702,553 S 4/2014 Jentzsch et al.
 D704,069 S * 5/2014 Handy D9/685
 D705,661 S 5/2014 Marotti et al.
 D708,651 S 7/2014 Martin et al.
 D711,180 S 8/2014 Villa
 D712,267 S 9/2014 Handy
 D714,644 S 10/2014 Wagner et al.
 D720,618 S * 1/2015 Handy D9/500
 D724,690 S 3/2015 Carlson et al.
 D728,373 S 5/2015 Marotti et al.
 D758,207 S 6/2016 Kaanta et al.
 D759,380 S 6/2016 Watkins
 D761,606 S 7/2016 Piretti
 D818,364 S * 5/2018 Rashid D9/500

OTHER PUBLICATIONS

“Dr. Jekyll & Mr. Hyde Packaging Includes a Pair of Different Beverages”, Trend Hunter Marketing, published Jan. 14, 2014, 14 pages, < <https://www.trendhunter.com/trends/dr-jekyll-mr-hyde-packaging> >.*
 “Pearl”, Wanted—The Bandit Craft Line, Saverglass Website, Downloads, Thematic Leaflets, Saverglass Inc., © 2016, downloaded document created Jul. 2017, 6 select pages, < <https://www.saverglass.com/en/downloads> >.*
 U.S. Trademark Registration No. 4860293, Registered on Nov. 24, 2015; owned by Immortal Brands LLC.
 Calvert Whiskey Decanter Bottle (1955); Vintage Alcohol Ads of the 1950s (p. 88); date uncertain (pre-2010); <http://www.vintageadbrowser.com/alcohol-ads-1950s/88>.
 Calvert Whiskey Decanter Bottle; date uncertain (pre-2010); <http://www.vintageadbrowser.com/search?q=calvert+whiskey&page=7>.
 Schenley Reserve Decanter; date uncertain (pre-2010); <https://www.drinksplanet.com/schenley-reserve-decanter-79465.html>.
 “Durkin” decanter; “Durkin” / Wholesale and Retail / Wines and Liquors / Mill and Sprague St. / Spokane, Wash.; date uncertain (pre-2010); <http://www.antiquebottles.com/whiskey/fame.html>.
 U.S. Trademark Registration No. 5258101, Registered on Aug. 8, 2017; owned by IAbacadabra Spirits Drinks S.L.
 Pearl decanter; Dec. 6, 2016; <https://www.saverglass.com/en/news/new-products/wanted-bandit-craft-line>.

* cited by examiner

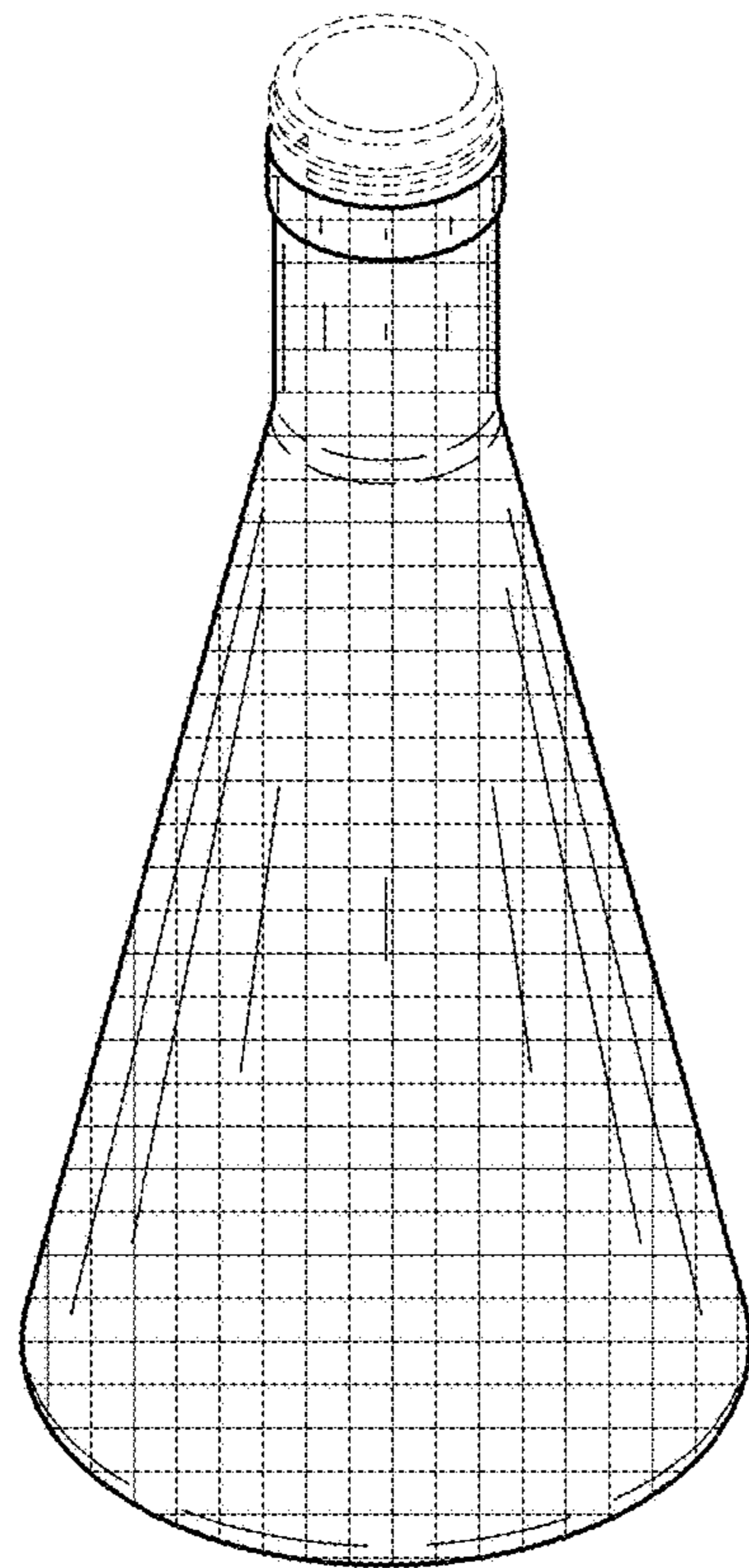

Fig. 1

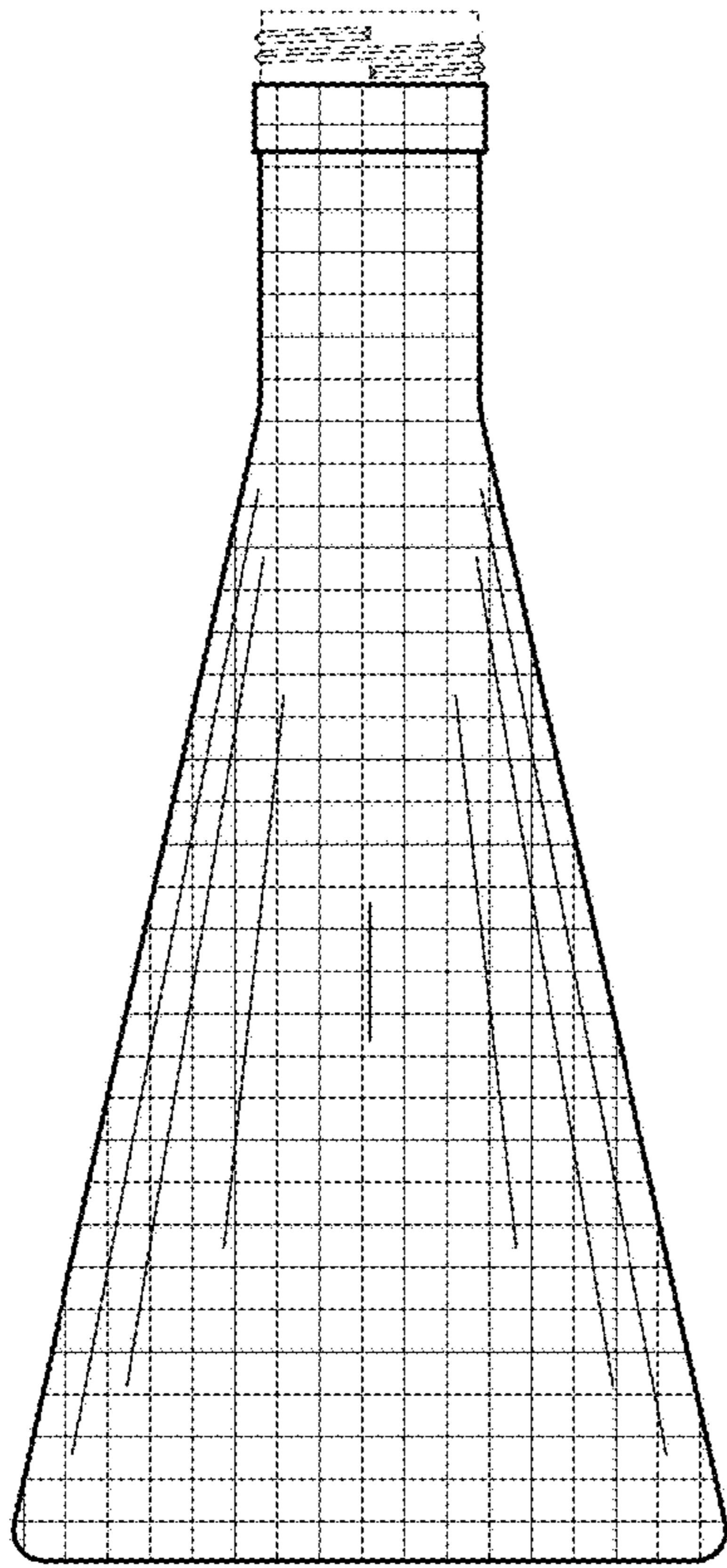

Fig. 2

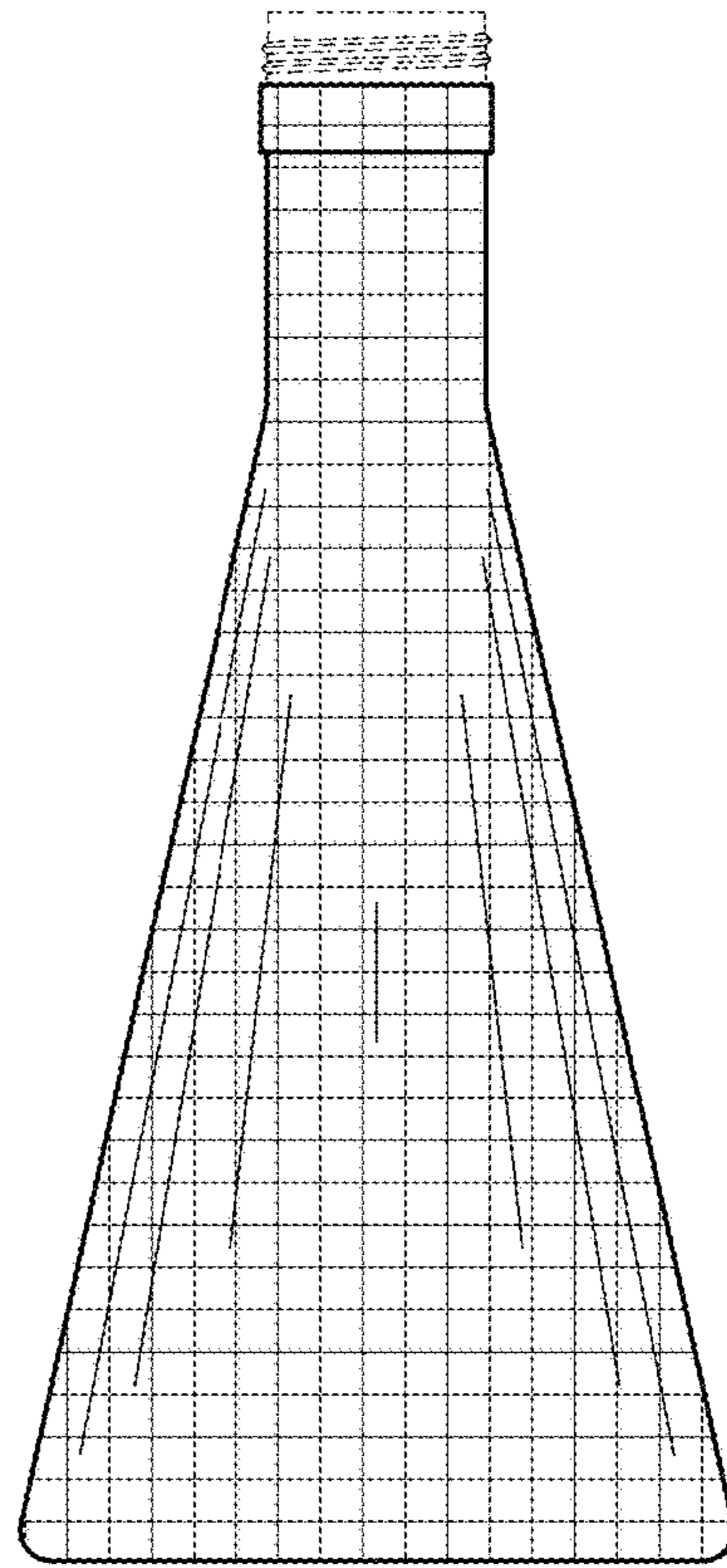

Fig. 3

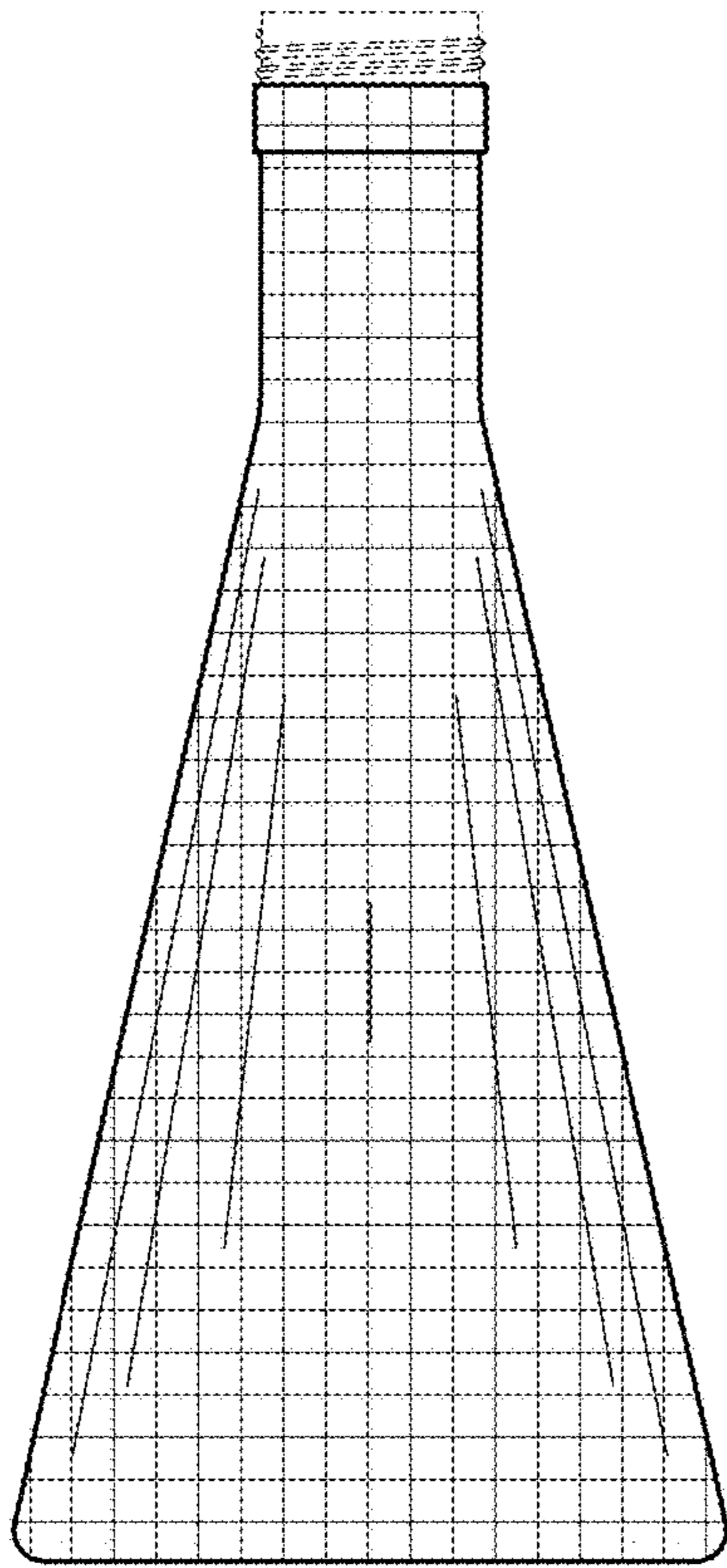

Fig. 4

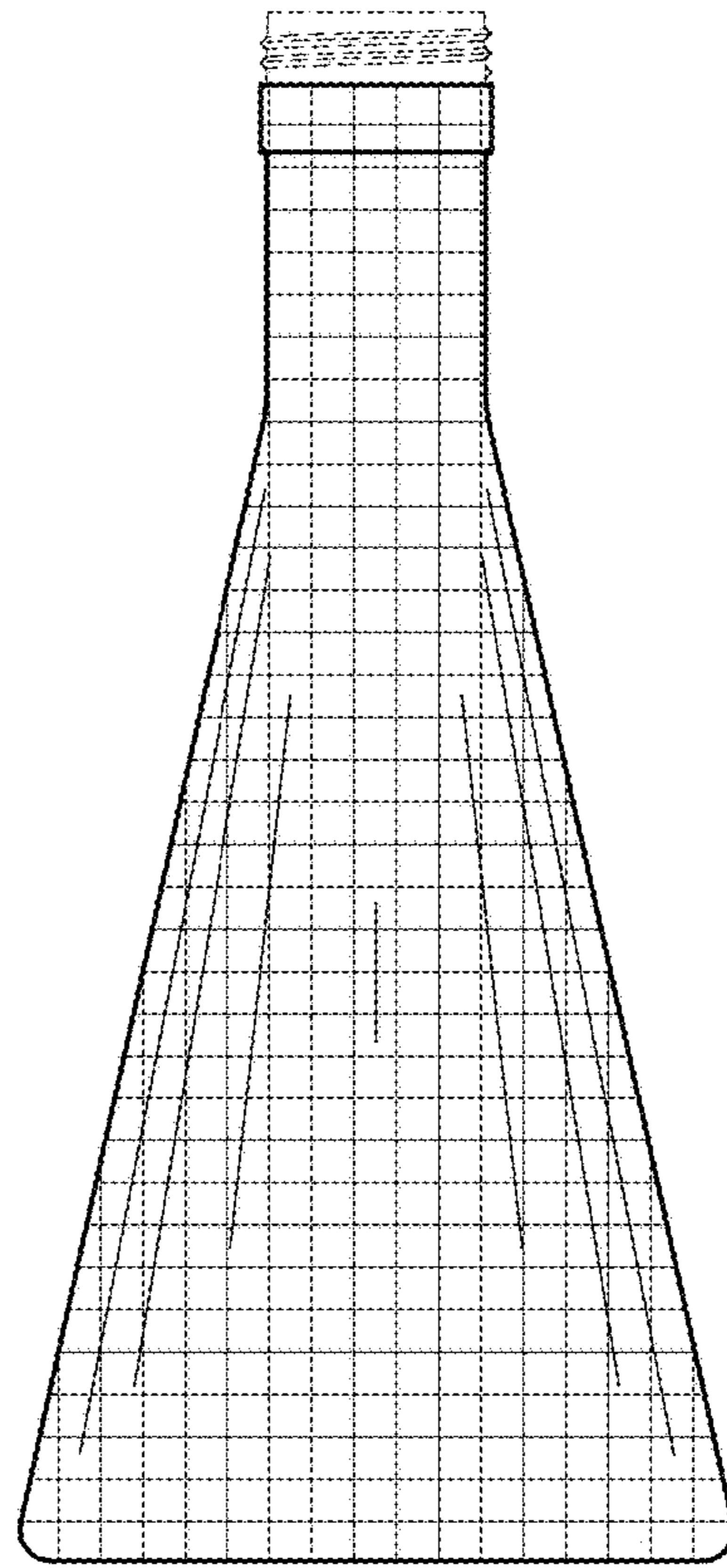

Fig. 5

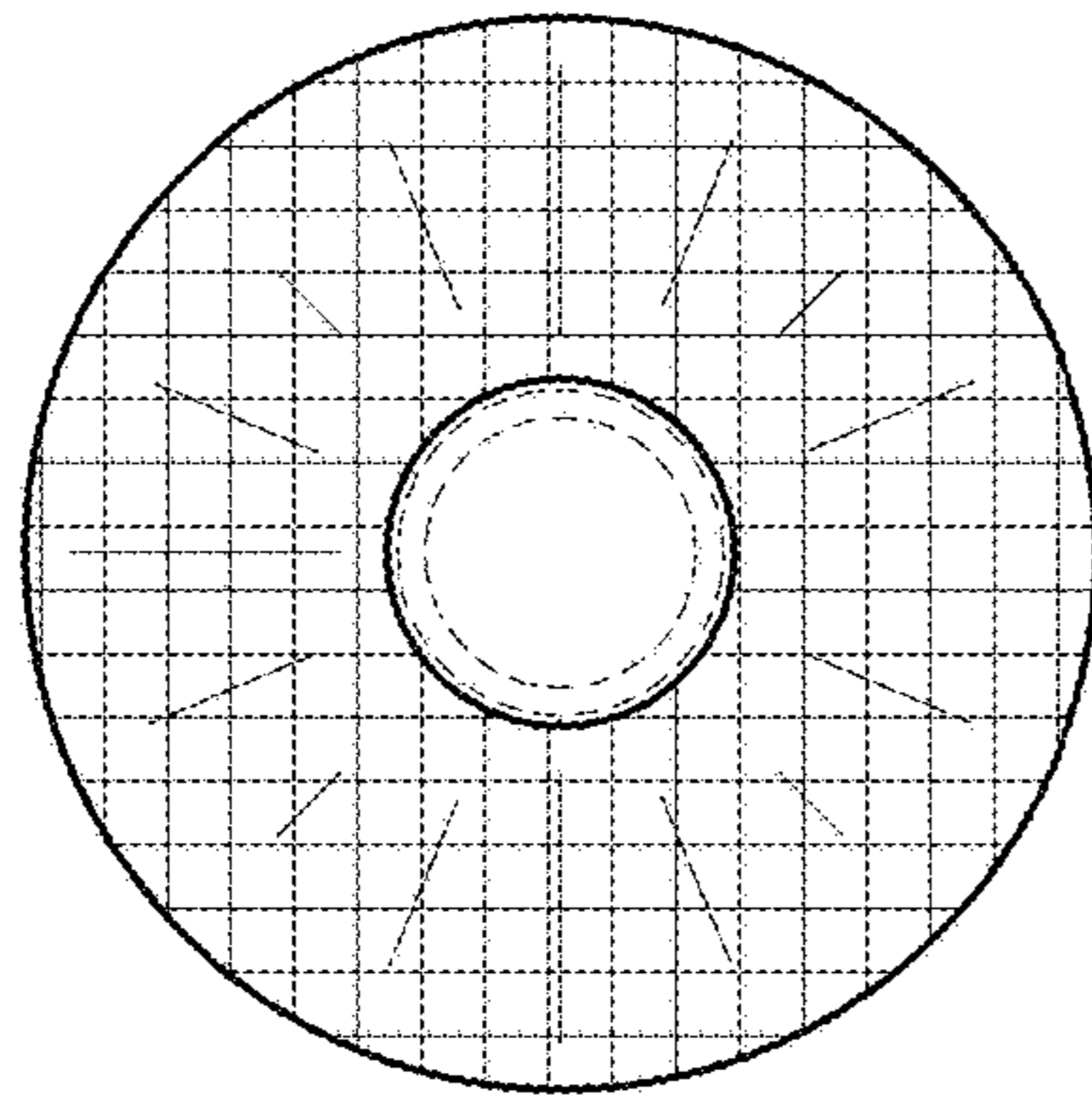

Fig. 6

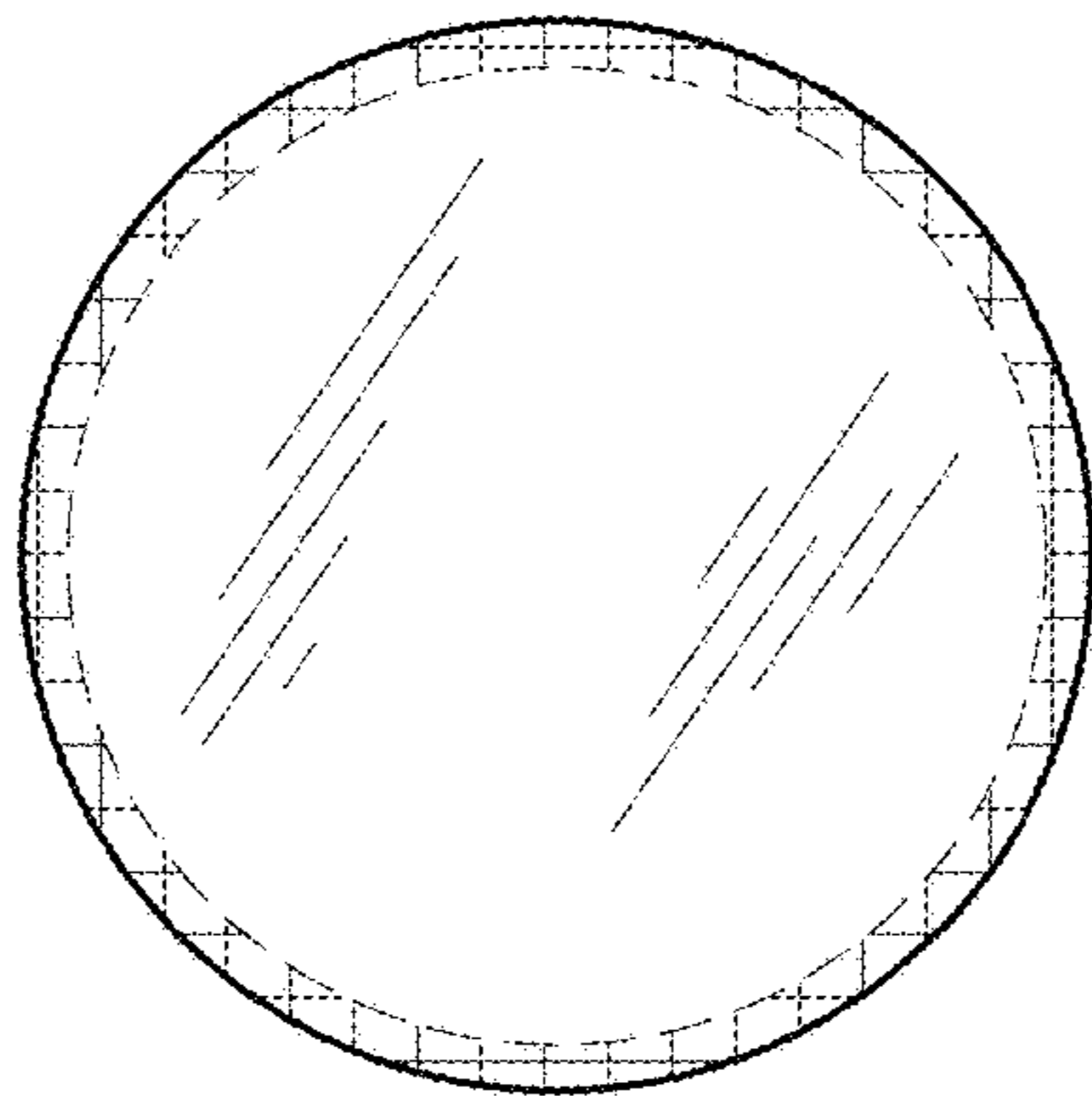

Fig. 7