



US00D845740S

(12) **United States Design Patent** (10) **Patent No.:** **US D845,740 S**
Bast (45) **Date of Patent:** **** Apr. 16, 2019**

(54) **HANDLE**
(71) Applicant: **Gauthier Biomedical, Inc.**, Grafton, WI (US)
(72) Inventor: **Robert Bast**, Sheboygan Falls, WI (US)
(73) Assignee: **Gauthier Biomedical, Inc.**, Grafton, WI (US)
(**) Term: **15 Years**
(21) Appl. No.: **29/617,953**
(22) Filed: **Sep. 18, 2017**

D591,860 S * 5/2009 Aparici D24/133
D613,144 S 4/2010 Lin
D618,527 S 6/2010 Deguglimo et al.
D637,942 S * 5/2011 Lee D11/218
D646,384 S 10/2011 Gauthier et al.
D646,385 S * 10/2011 Gauthier D24/133
D646,783 S * 10/2011 Bast D24/133
D647,819 S * 11/2011 Kolasa D11/218
D649,635 S * 11/2011 Cronin D24/133
D673,831 S 1/2013 Molina et al.
D700,033 S 2/2014 Lin
D702,595 S * 4/2014 Fretz D11/218
D734,115 S 7/2015 Robinson et al.
D754,512 S 4/2016 Nelson
D799,371 S * 10/2017 Chan D11/216
2010/0180732 A1 7/2010 Gauthier
2010/0288087 A1 11/2010 Lai

* cited by examiner

Related U.S. Application Data

(62) Division of application No. 29/500,379, filed on Aug. 25, 2014, now Pat. No. Des. 797,540.
(51) **LOC (11) Cl.** **08-05**
(52) **U.S. Cl.**
USPC **D8/107**; D24/133
(58) **Field of Classification Search**
USPC D8/14, 21, 82, 83, 84, 85, 86, 107, 300, D8/303, 34; D7/395; D32/41, 46, 48, D32/49; D24/133; D11/218
CPC B25B 15/02; B25B 15/04; B25B 15/06; B25G 1/025; B25G 1/085
See application file for complete search history.

Primary Examiner — Philip S Hyder

(74) *Attorney, Agent, or Firm* — Boyle Fredrickson, S.C.

(57) **CLAIM**

The ornamental design for a handle, as shown and described.

DESCRIPTION

FIG. 1 is a perspective view of a handle embodying my new design;
FIG. 2 is a front elevation view thereof;
FIG. 3 is a rear elevation view thereof;
FIG. 4 is a right side elevation view thereof;
FIG. 5 is a left side elevation view thereof;
FIG. 6 is a top plan view thereof; and,
FIG. 7 is a bottom plan view thereof.
The broken lines depict portions of the handle in which the design is embodied that are not considered part of the claimed design.

(56) **References Cited**

U.S. PATENT DOCUMENTS

D356,239 S 3/1995 Lin
6,151,998 A 11/2000 Fu-Hui
D536,280 S * 2/2007 Wemmer D11/218
7,272,999 B2 9/2007 Cutler et al.

1 Claim, 4 Drawing Sheets

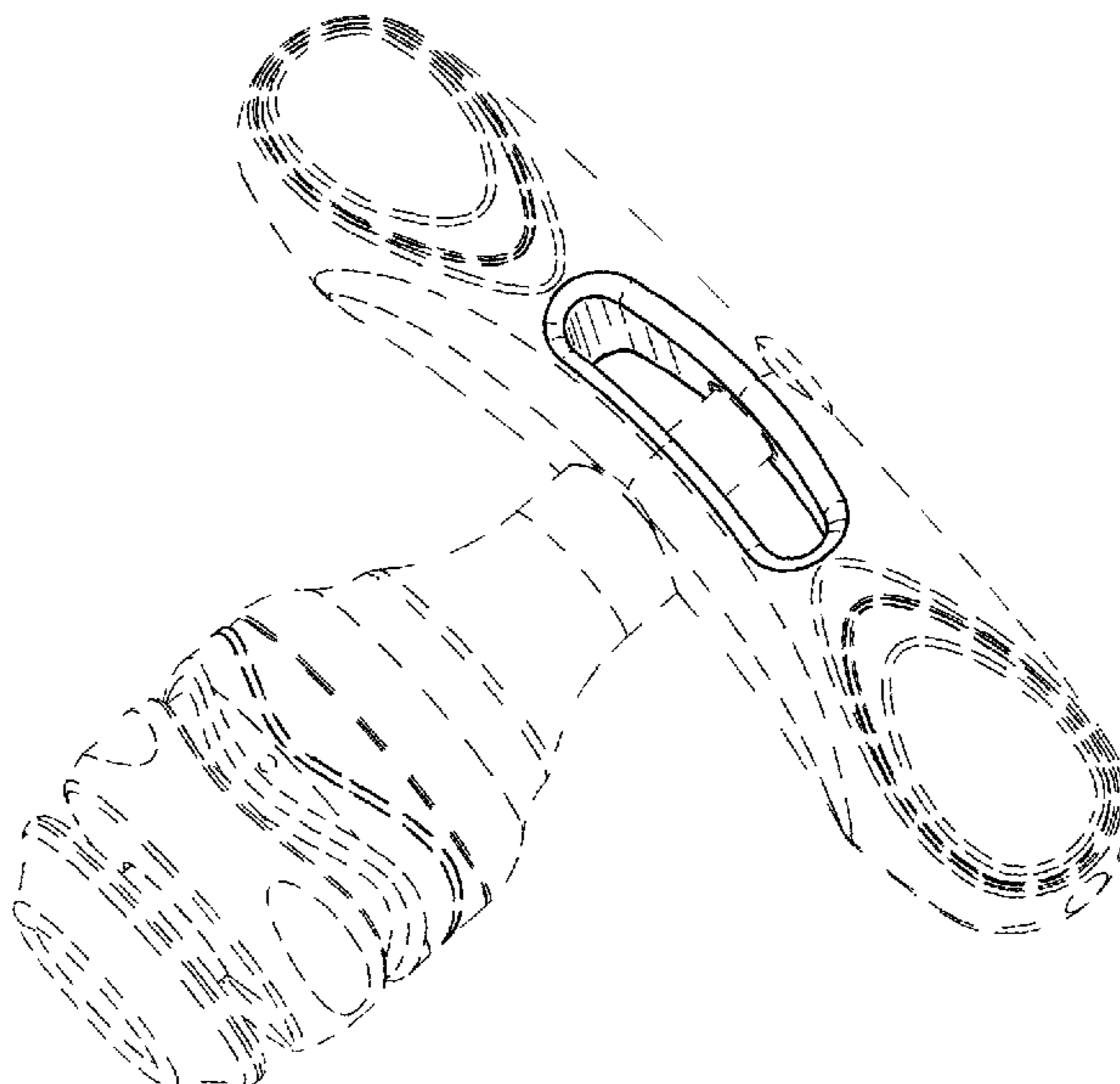

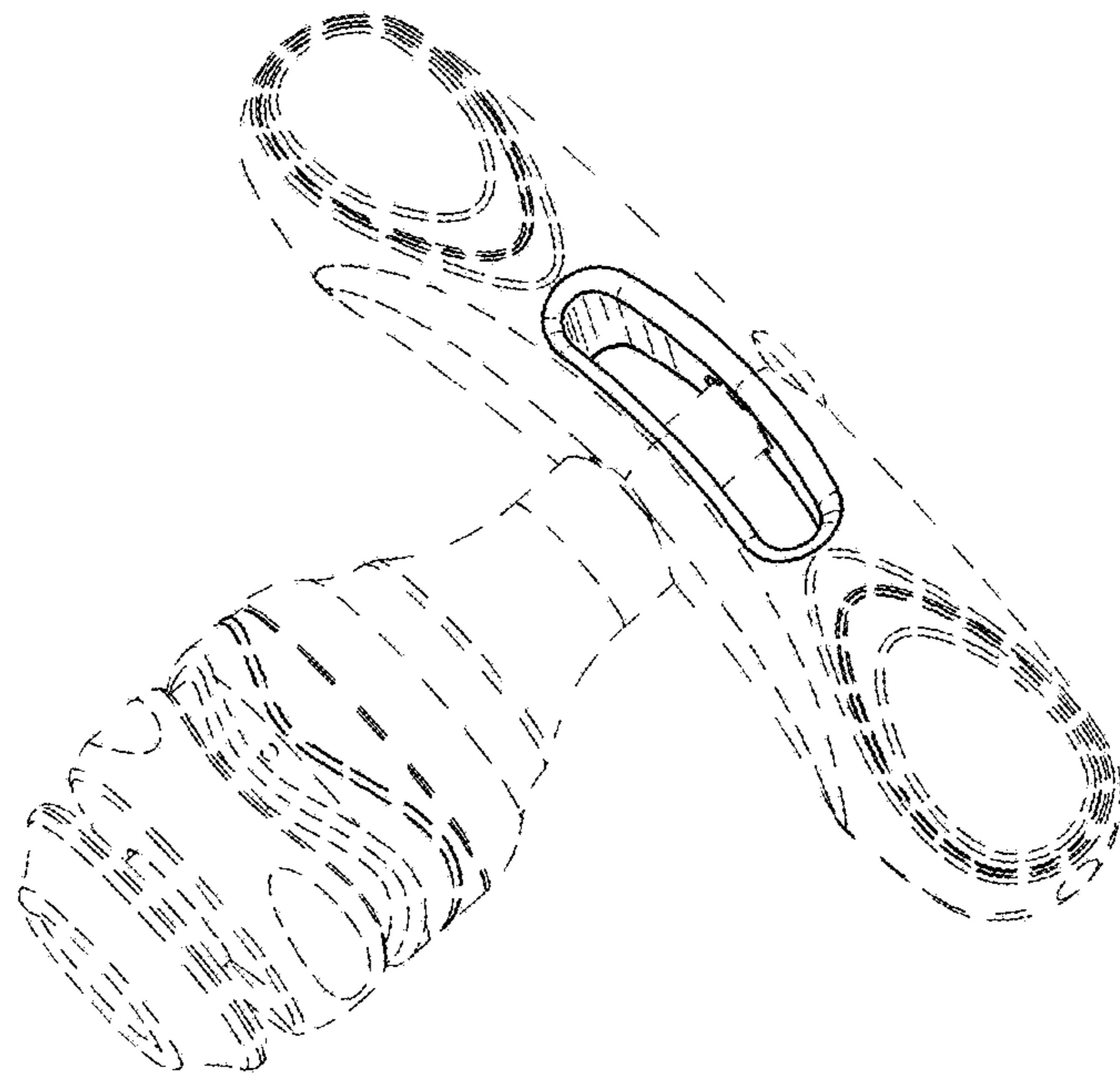

FIG. 1

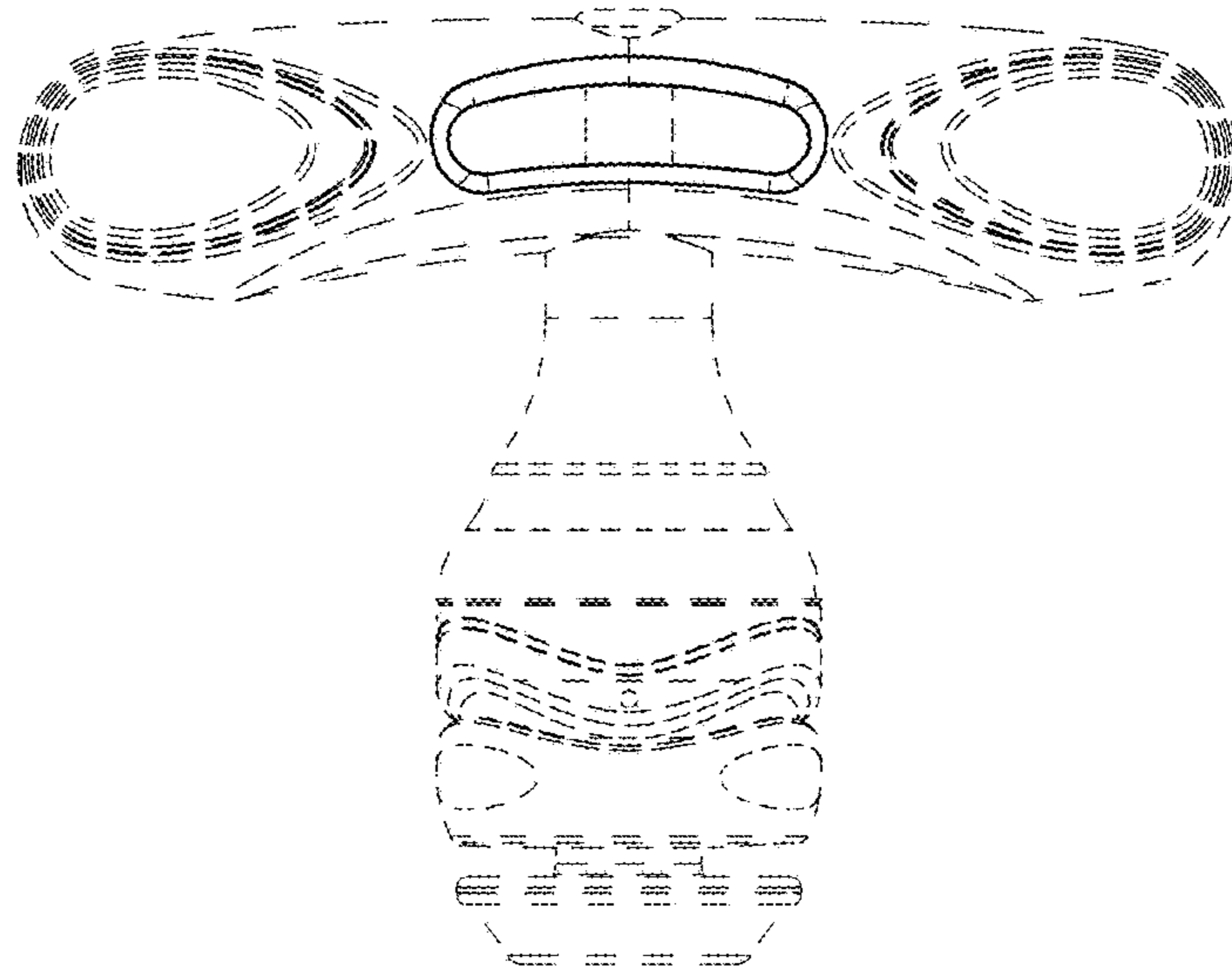

FIG. 2

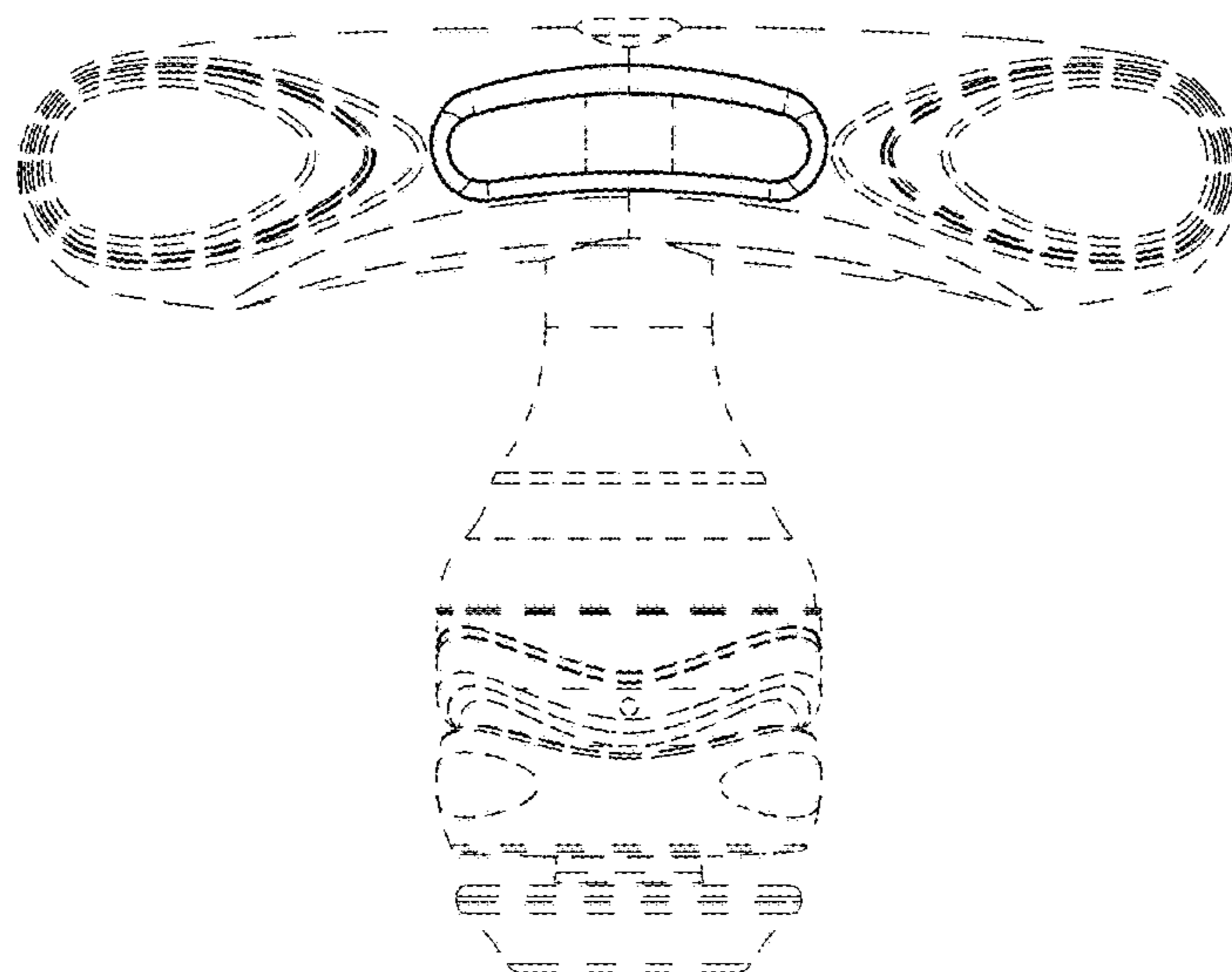

FIG. 3

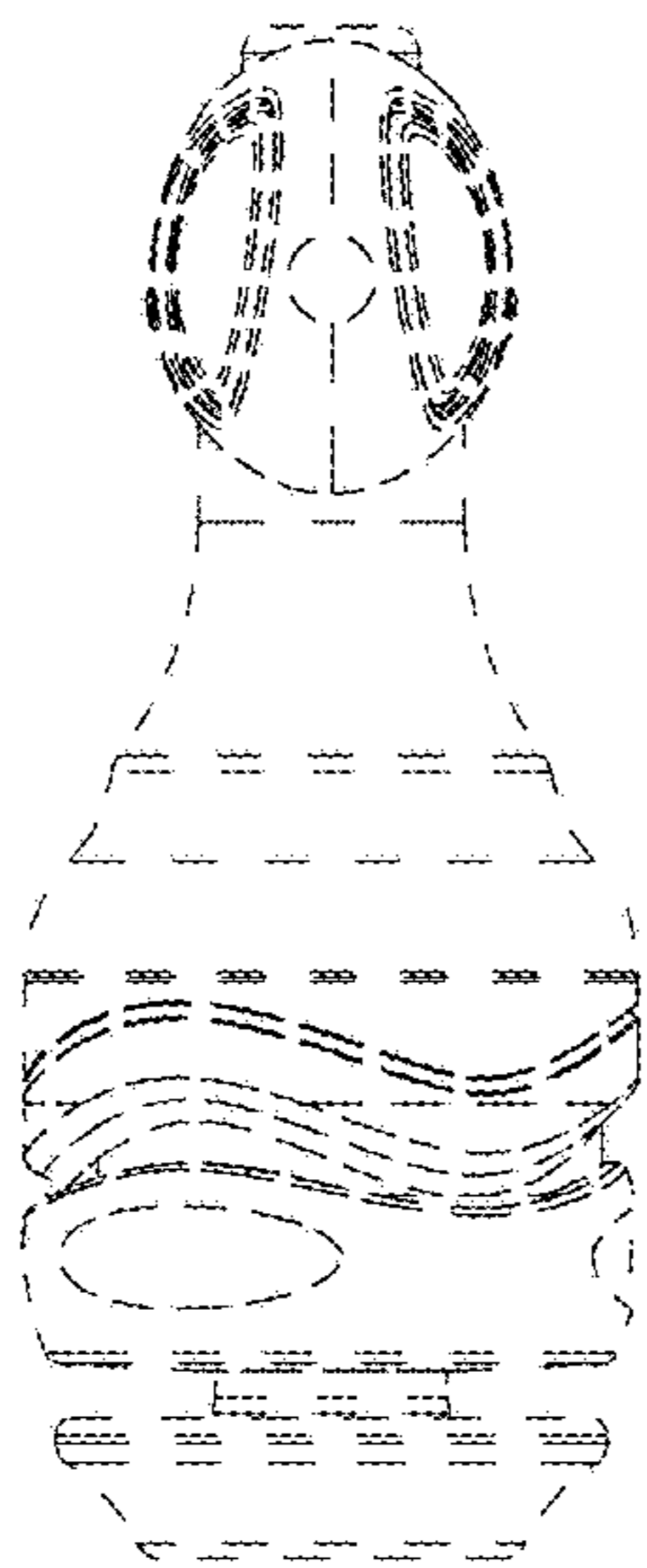

FIG. 4

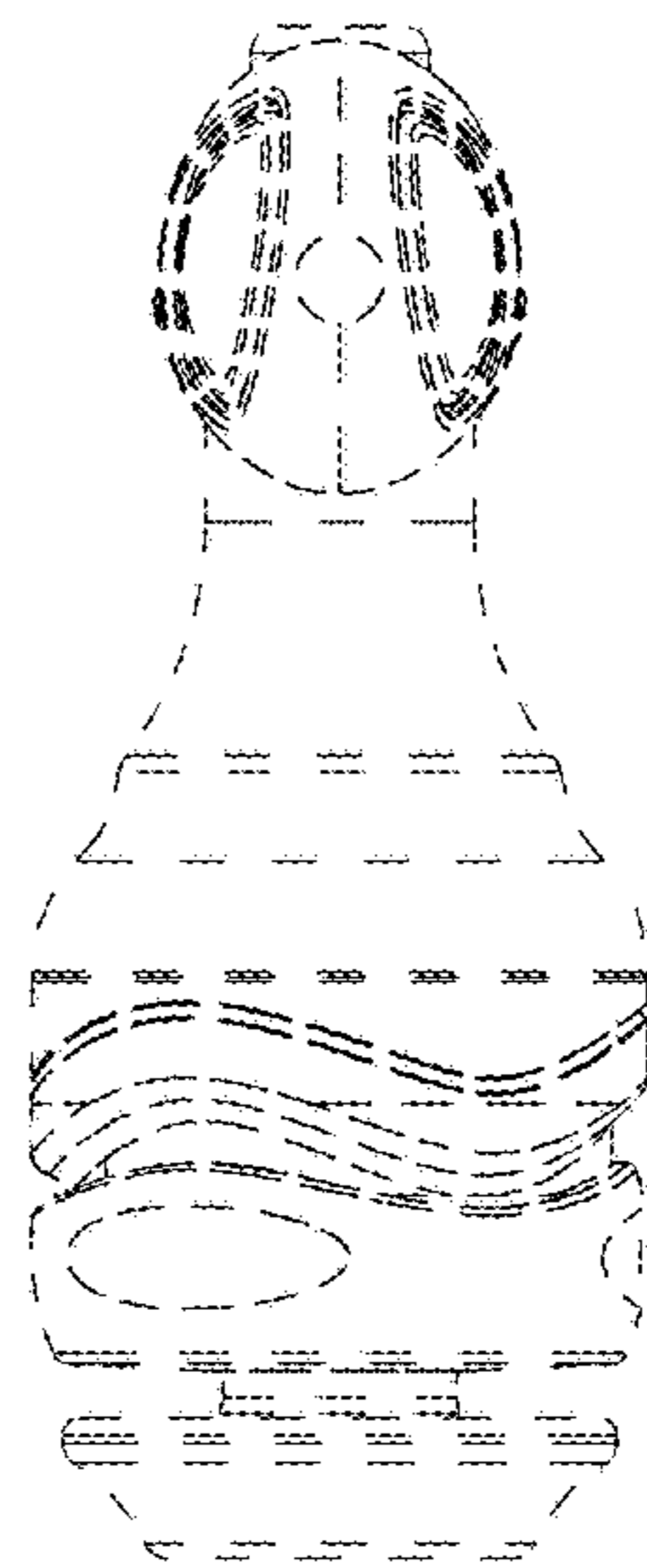

FIG. 5

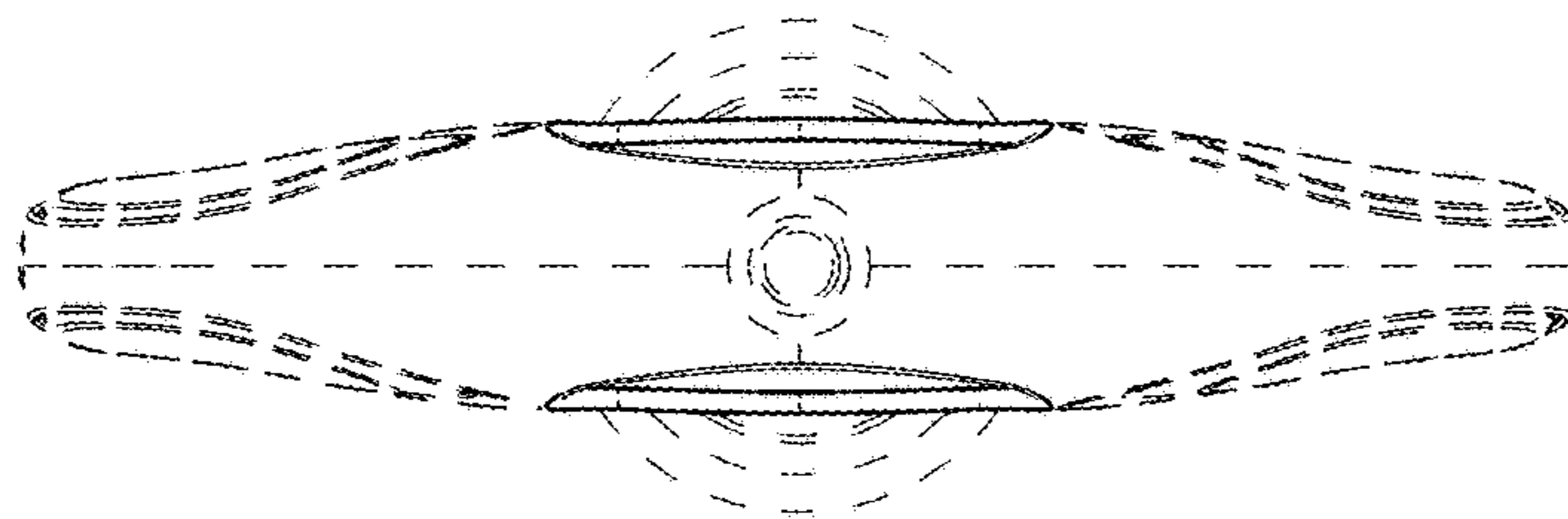

FIG. 6

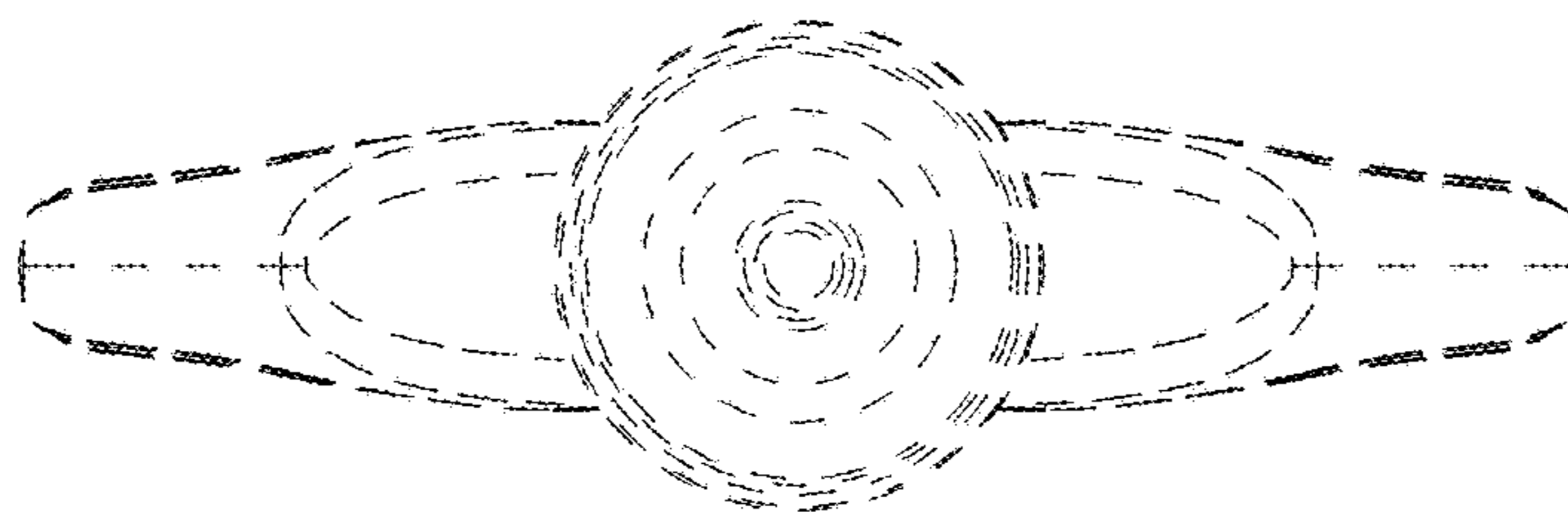

FIG. 7