



US00D845690S

(12) **United States Design Patent**  
**Handler et al.**

(10) **Patent No.:** **US D845,690 S**

(45) **Date of Patent:** **\*\* Apr. 16, 2019**

(54) **TABLE**

(71) Applicant: **Art Design Works LLC**, Lexington, MA (US)

(72) Inventors: **Sheryl Handler**, Cambridge, MA (US); **Carl Martinez**, Easton, PA (US); **Kelly Louise Casilio**, West Newton, MA (US); **Nadine M. Volicer**, Boston, MA (US)

(73) Assignee: **Art Design Works LLC**, Lexington, MA (US)

(\*\*) Term: **15 Years**

(21) Appl. No.: **29/586,725**

(22) Filed: **Dec. 6, 2016**

**Related U.S. Application Data**

(62) Division of application No. 29/502,743, filed on Sep. 18, 2014, now Pat. No. Des. 781,629.

(51) **LOC (11) Cl.** ..... **06-06**

(52) **U.S. Cl.**  
USPC ..... **D6/707.22**

(58) **Field of Classification Search**  
USPC ..... D6/641, 644, 650, 656, 685, 696, D6/696.1-696.7, 707, 707.22; D1/128; D20/11, 22, 23, 40; D24/189; D32/40, D32/43  
CPC .. A47B 5/00; A47B 7/00; A47B 13/00; A47B 13/02; A47B 13/08; A47B 13/081; A47B 13/088; A47B 13/10; A47B 13/12; A47B 21/00; A47B 2200/0001; A47B 2200/0006

See application file for complete search history.

(56) **References Cited**

**U.S. PATENT DOCUMENTS**

D193,790 S 10/1962 Ohlsson  
3,267,881 A \* 8/1966 Saggione ..... A47B 13/10  
108/59

D207,851 S 6/1967 Separa  
D244,734 S 6/1977 Laroye  
D333,228 S 2/1993 Hosoe  
D352,853 S 11/1994 Hosoe  
(Continued)

**OTHER PUBLICATIONS**

U.S. Appl. No. 29/502,743, filed Sep. 18, 2014, Handler et al.  
(Continued)

*Primary Examiner* — Mary Ann Calabrese

(74) *Attorney, Agent, or Firm* — Wolf, Greenfield & Sacks, P.C.

(57) **CLAIM**

The ornamental design for a table, as shown and described.

**DESCRIPTION**

FIG. 1 is a top, front perspective view of a table showing a first embodiment of our new design;  
FIG. 2 is a front elevational view thereof;  
FIG. 3 is a rear elevational view thereof;  
FIG. 4 is a left side elevational view thereof;  
FIG. 5 is a right side elevational view thereof;  
FIG. 6 is a top plan view thereof;  
FIG. 7 is a bottom plan view thereof;  
FIG. 8 is a top, front, left perspective view showing a second embodiment thereof;  
FIG. 9 is a front elevational view thereof;  
FIG. 10 is a rear elevational view thereof;  
FIG. 11 is a left side elevational view thereof;  
FIG. 12 is a right side elevational view thereof;  
FIG. 13 is a top plan view thereof; and,  
FIG. 14 is a bottom plan view thereof.  
The broken lines show portions of the table that form no part of the claimed design.

**1 Claim, 12 Drawing Sheets**

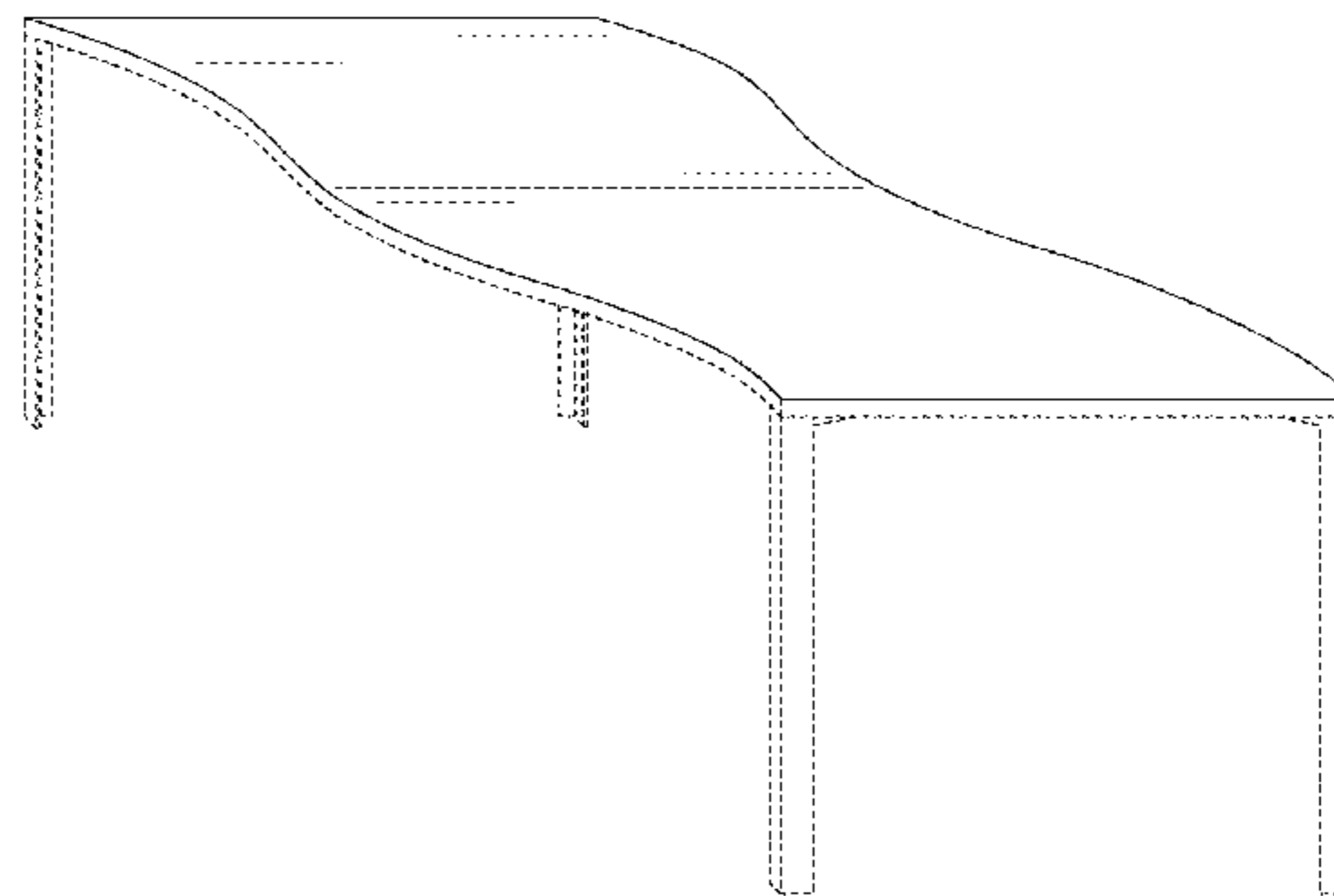
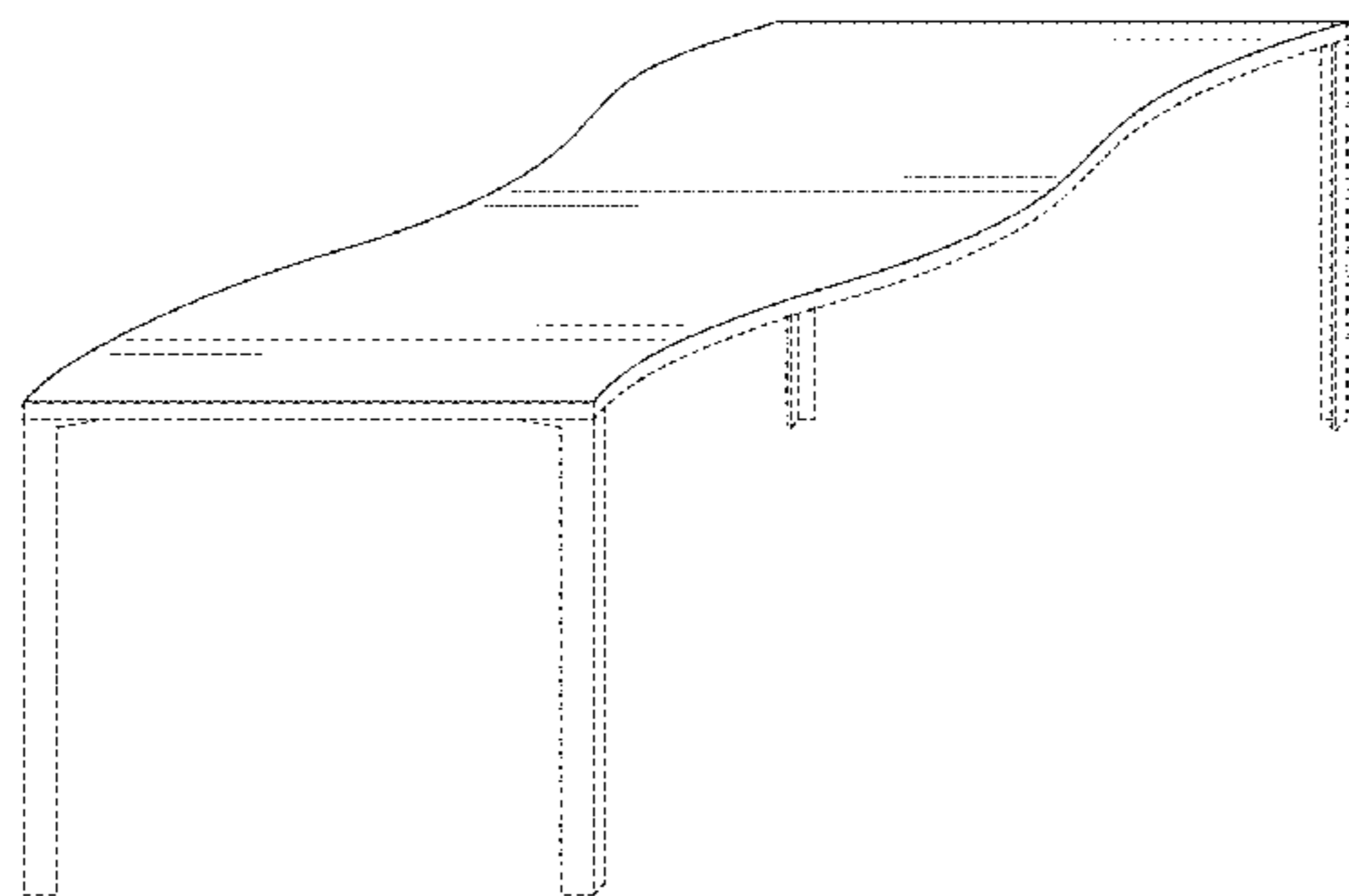

(56)

References Cited

U.S. PATENT DOCUMENTS

D383,924 S 9/1997 Dormon et al.  
 D388,639 S 1/1998 Dormon et al.  
 D390,381 S 2/1998 Dormon et al.  
 D414,813 S \* 10/1999 Browning ..... D20/22  
 D417,094 S 11/1999 Schwartz  
 D449,750 S 10/2001 Antonioni  
 6,363,866 B1 4/2002 Schwartz  
 D501,741 S 2/2005 Risdall  
 D524,580 S 7/2006 Chang  
 D527,209 S 8/2006 Nicoletti  
 D528,658 S \* 9/2006 Mueller ..... D24/189  
 7,249,741 B1 \* 7/2007 Larson ..... A47B 13/02  
 108/150  
 D556,966 S \* 12/2007 Herbrand ..... D32/40  
 D559,580 S 1/2008 Newhouse et al.  
 D562,461 S \* 2/2008 Nash ..... D24/189  
 D572,505 S 7/2008 Davis  
 D576,823 S 9/2008 Derocher et al.  
 D577,167 S \* 9/2008 Bogaerts ..... D32/40  
 D580,553 S \* 11/2008 Nash ..... D24/189  
 D604,469 S \* 11/2009 Rolstad ..... A47B 13/02  
 D32/40  
 D611,727 S 3/2010 Vail  
 D659,327 S \* 5/2012 Davis ..... D32/40

D670,089 S 11/2012 Frobose et al.  
 D703,984 S 5/2014 Nasser et al.  
 D752,316 S \* 3/2016 Gil ..... D1/128  
 D781,629 S \* 3/2017 Handler ..... D6/707.22  
 D793,136 S \* 8/2017 Grano ..... D6/697.1

OTHER PUBLICATIONS

U.S. Appl. No. 29/586,716, filed Dec. 6, 2016, Handler et al.  
 U.S. Appl. No. 29/586,723, filed Dec. 6, 2016, Handler et al.  
 Brisk Desk Systems. Dcwebtools.com (online). 2005 [retrieved Jul. 18, 2016]. Retrieved from the Internet: <URL: <http://www.dcwebtools.com/sw/swchannel/images/ProductCatalog/ProductPage/File/ACF41A.pdf>>.  
 Correll FS3096S 30" x 96" Granite Gray Plastic Serpentine Fold in Half Table. Webstaurantstore.com [online]. Earliest date Mar. 11, 2013 [retrieved Jul. 18, 2016]. Retrieved from the internet: <URL: [http://www.webstaurantstore.com/...rdb1jtxm8up\\_uwsjadu\\_8pwy3szrrzwsvdgaa2gvfgrrygekwwj2bxqc7qdlvujhocp4rw\\_wcb](http://www.webstaurantstore.com/...rdb1jtxm8up_uwsjadu_8pwy3szrrzwsvdgaa2gvfgrrygekwwj2bxqc7qdlvujhocp4rw_wcb)>.  
 Curve TV Stand by Off the Wall. Wayfair.com [online]. Nov. 3, 2015 [retrieved Jul. 18, 2016]. Retrieved from the Internet: <URL: <https://www.wayfair.com/Curve-TV-Stand-CRV-1500-OFTW1006.html?source=hotdeals>>.

\* cited by examiner

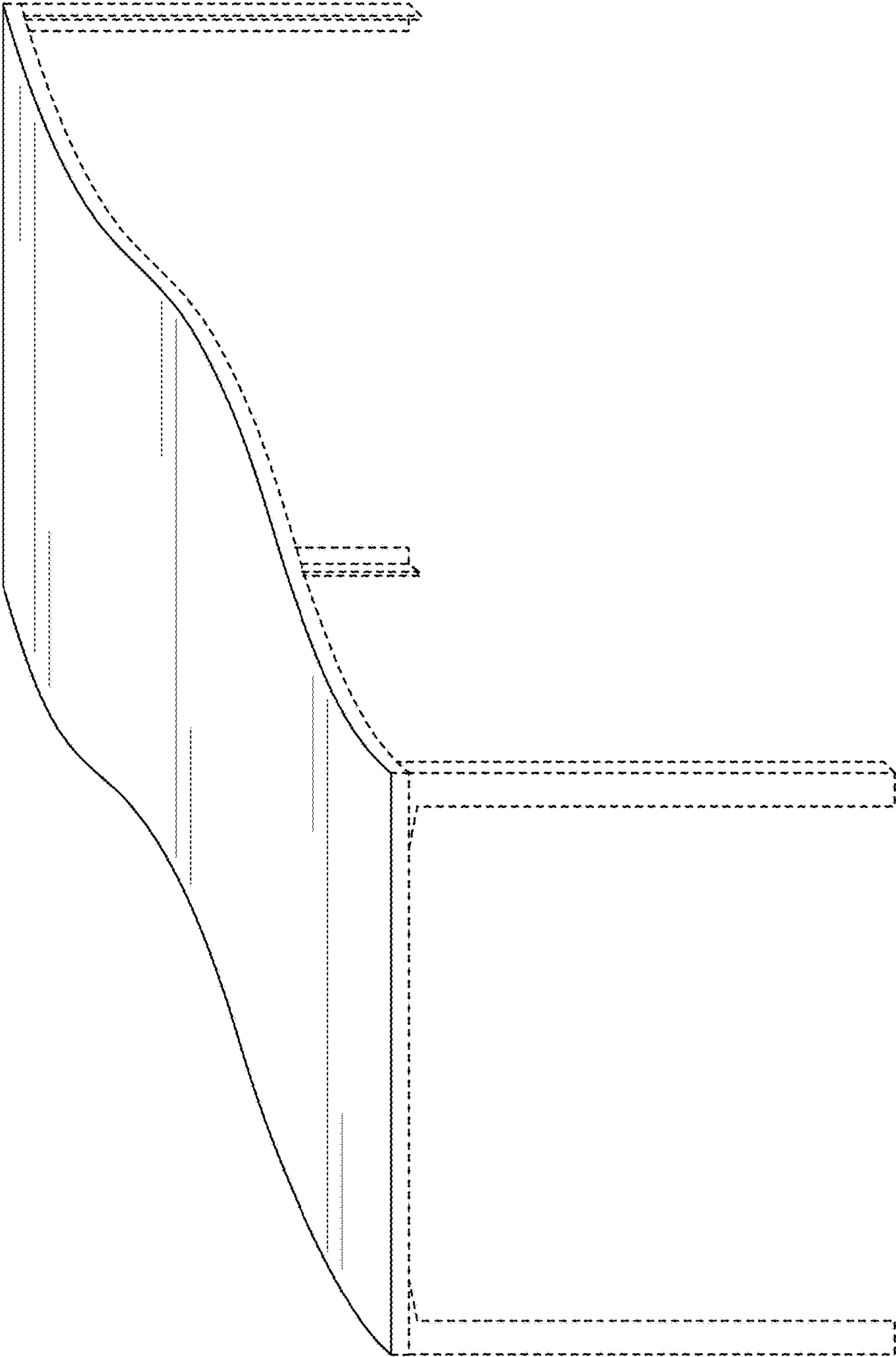

FIG. 1

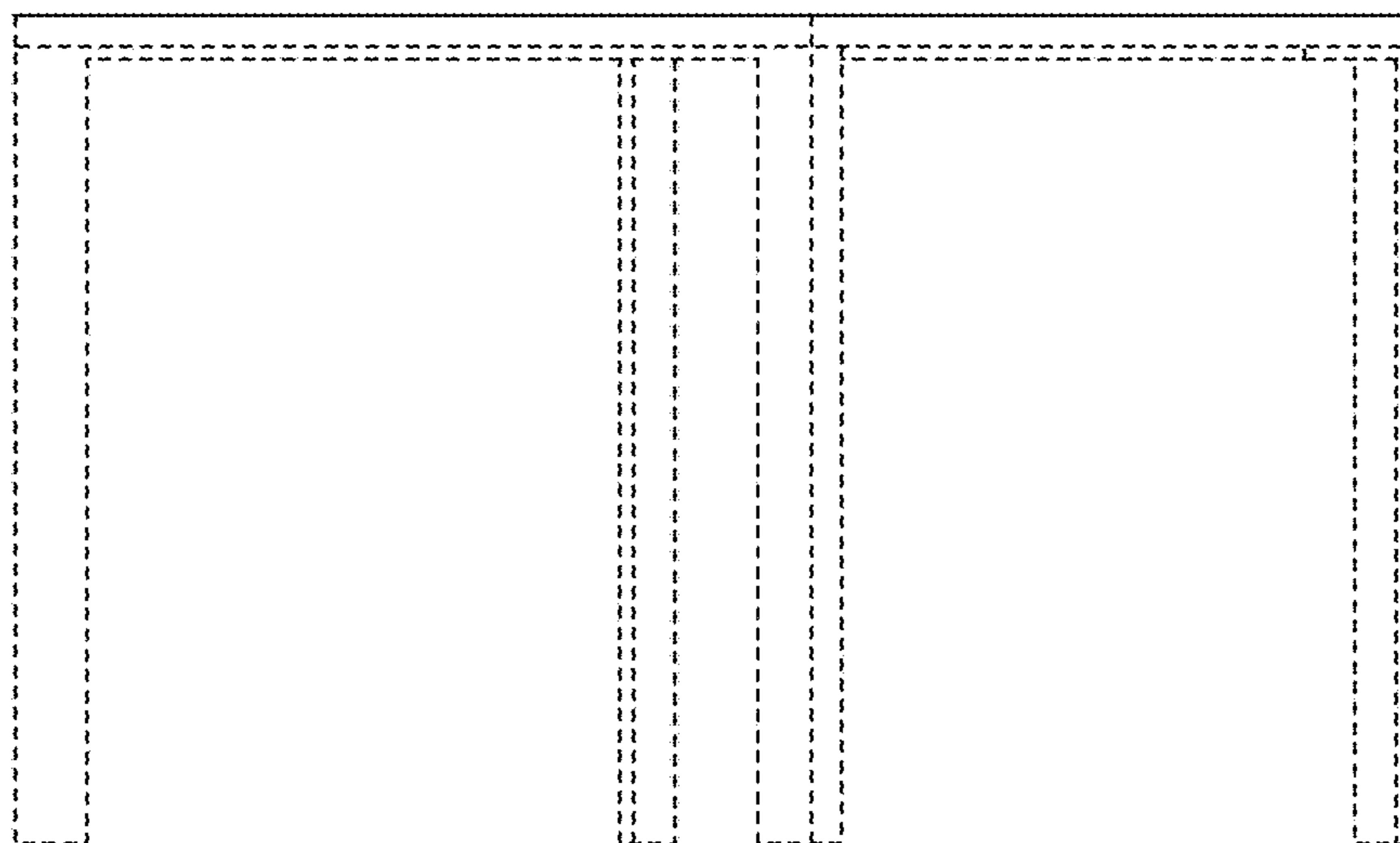

FIG. 2

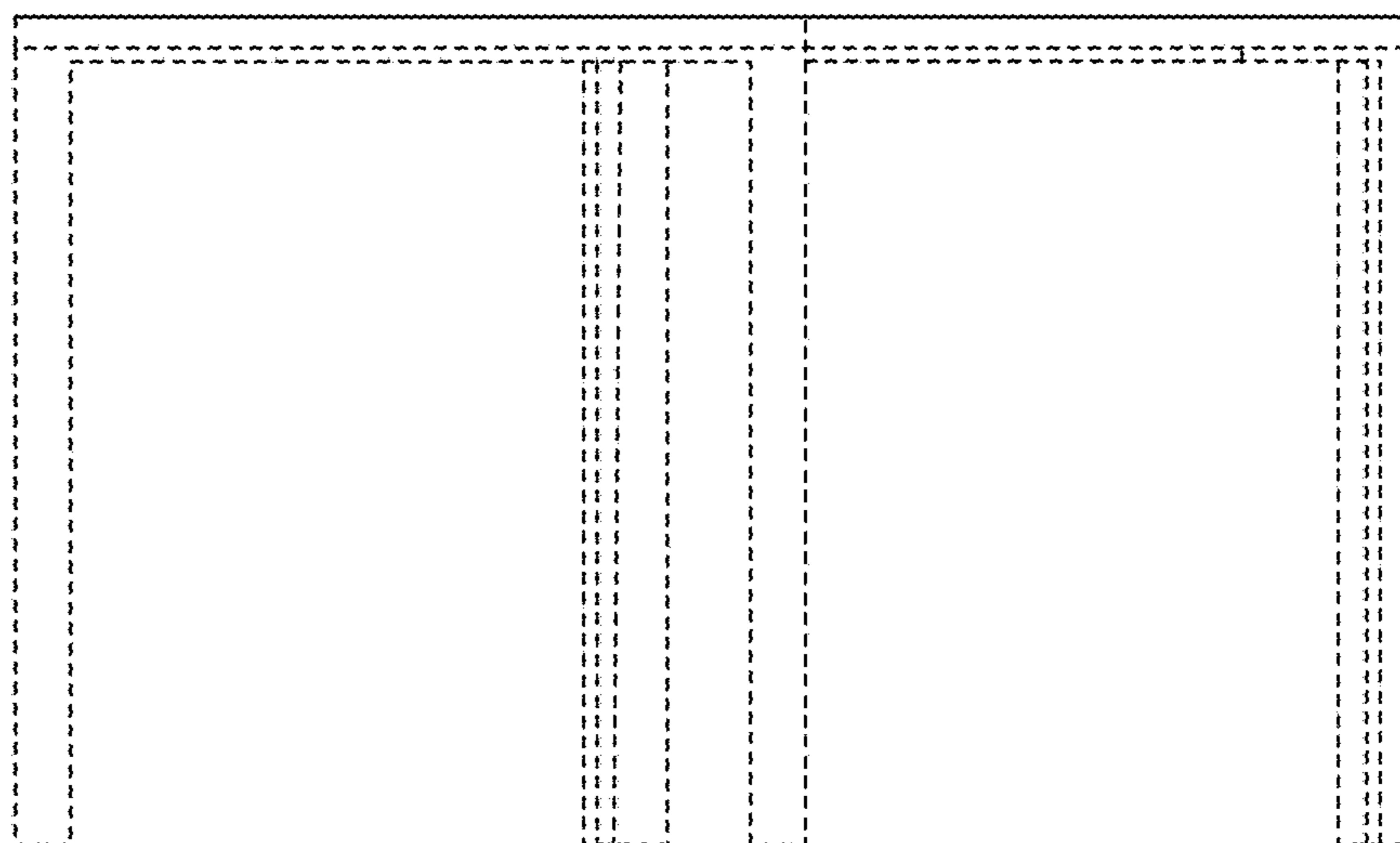

FIG. 3

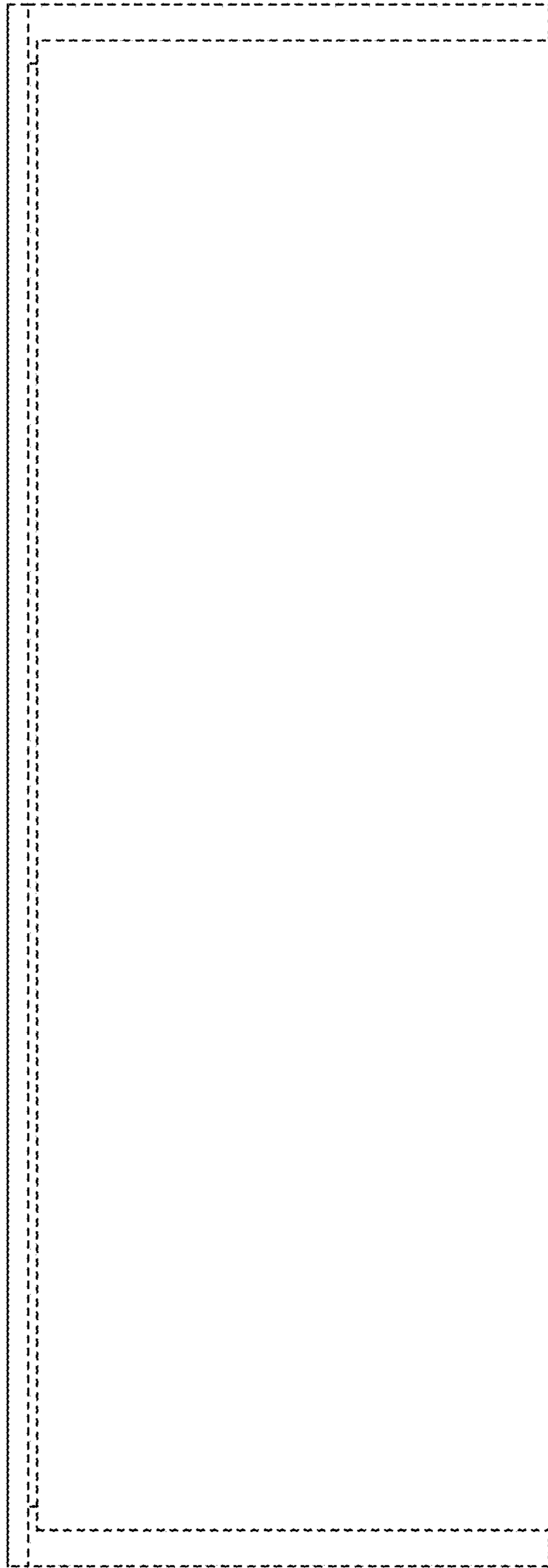

FIG. 4

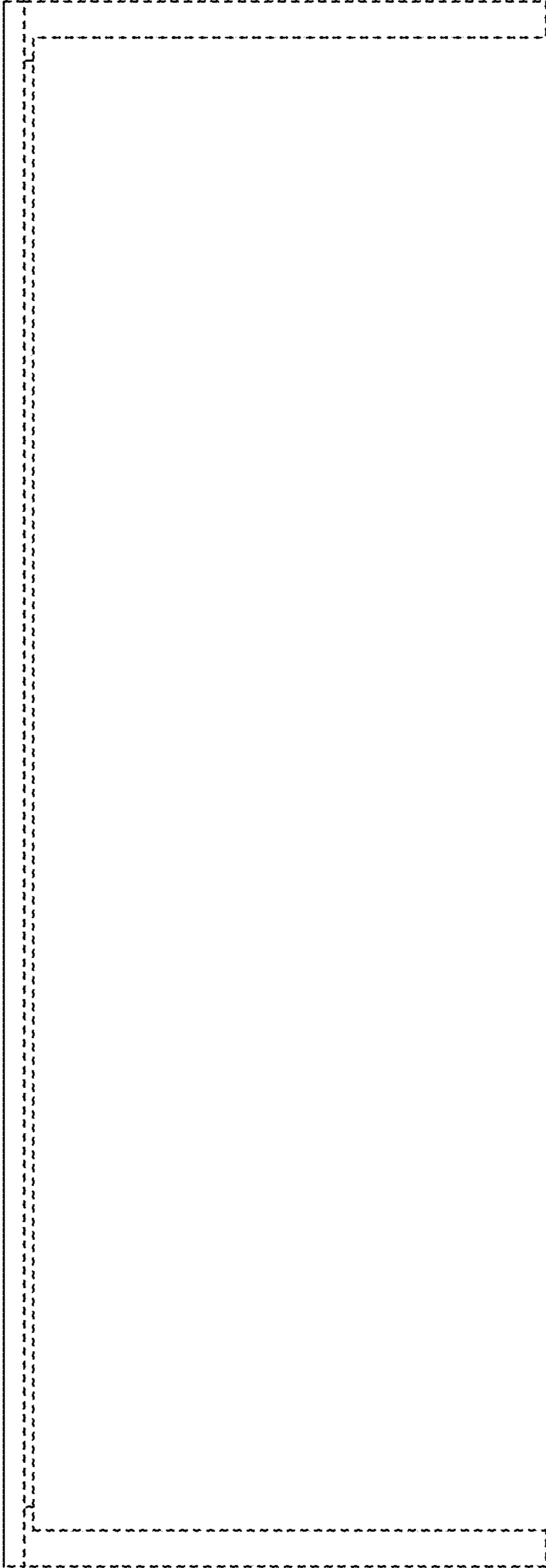

FIG. 5

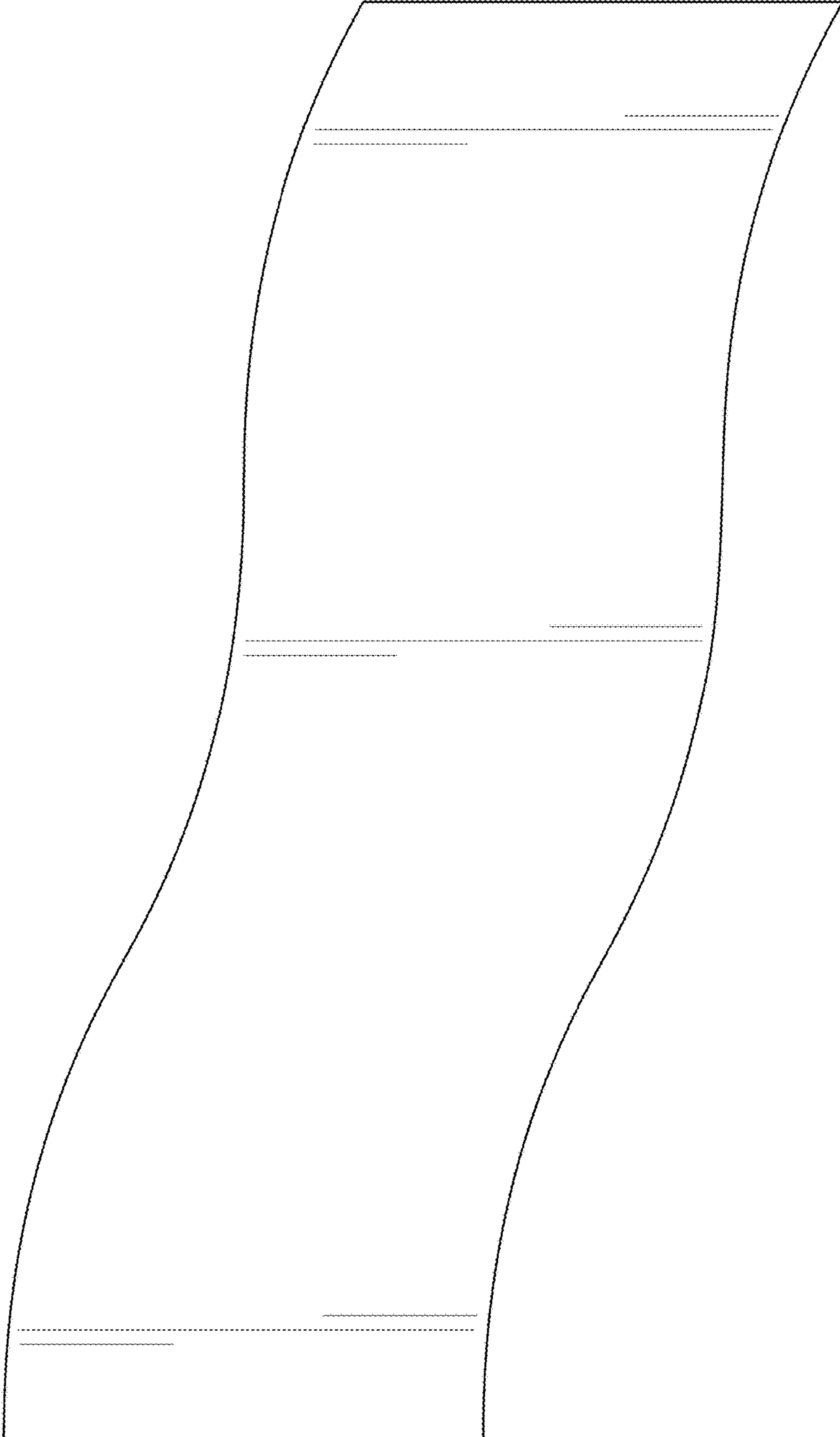

FIG. 6



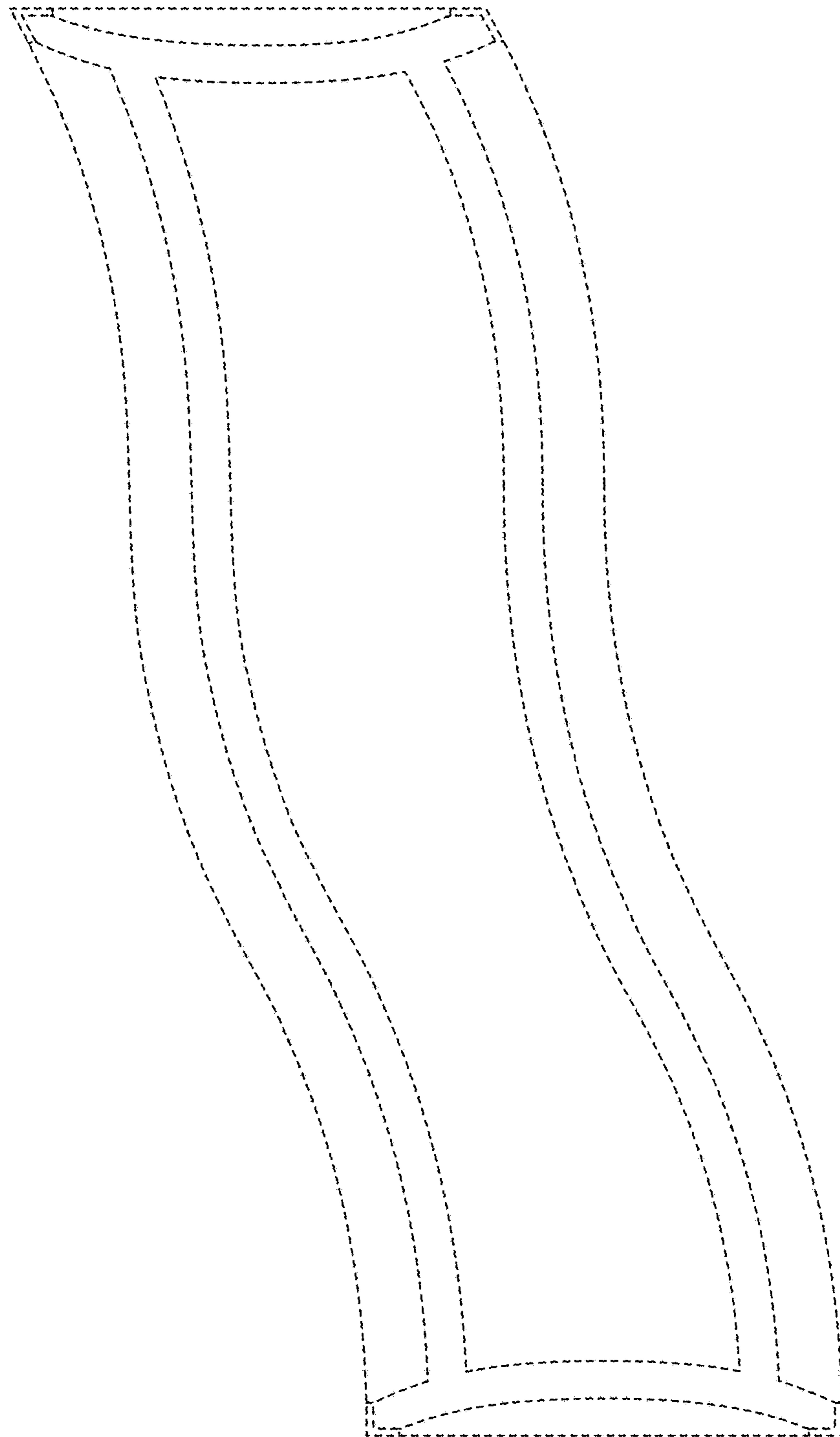

FIG. 7



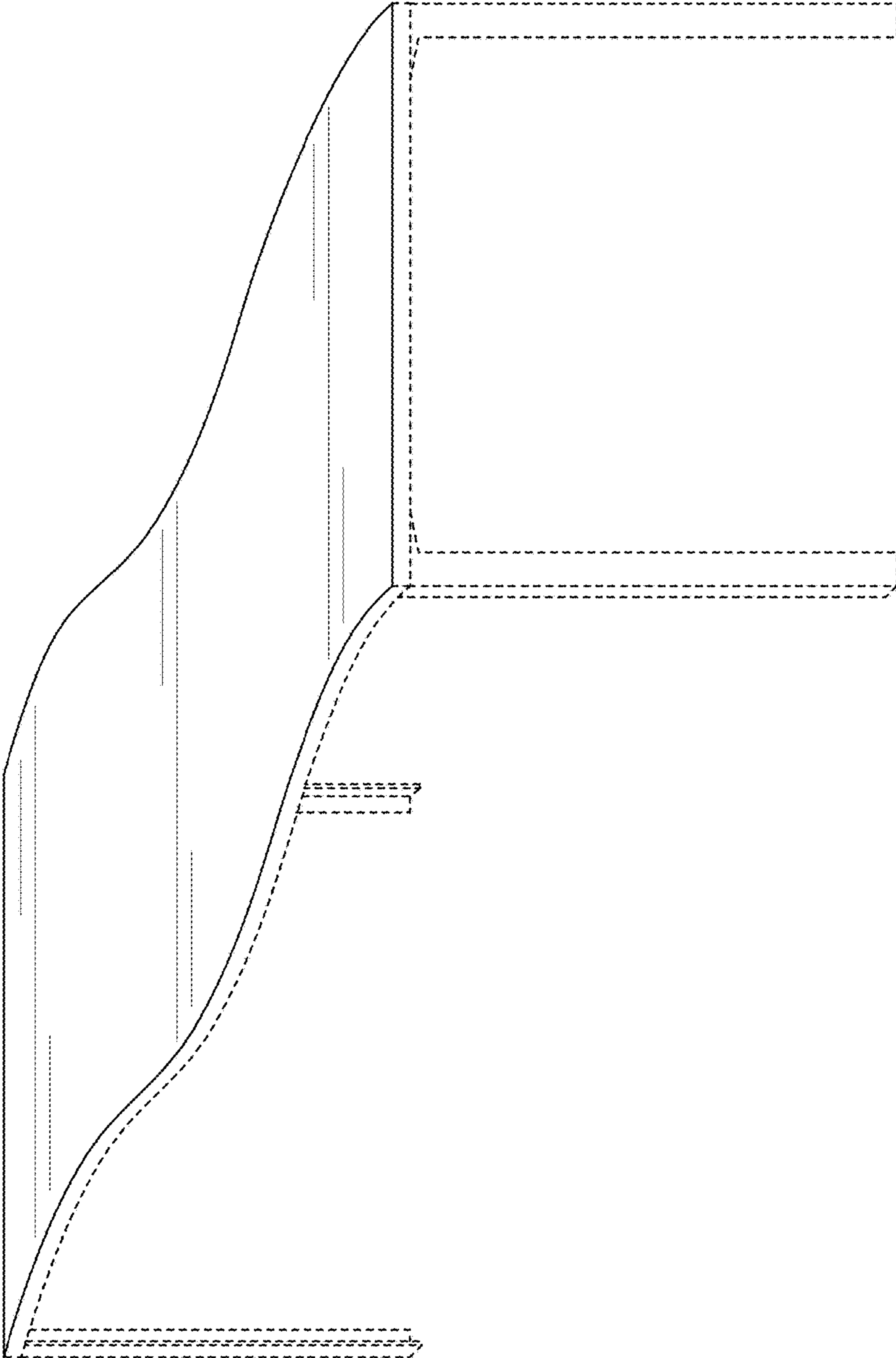

FIG. 8

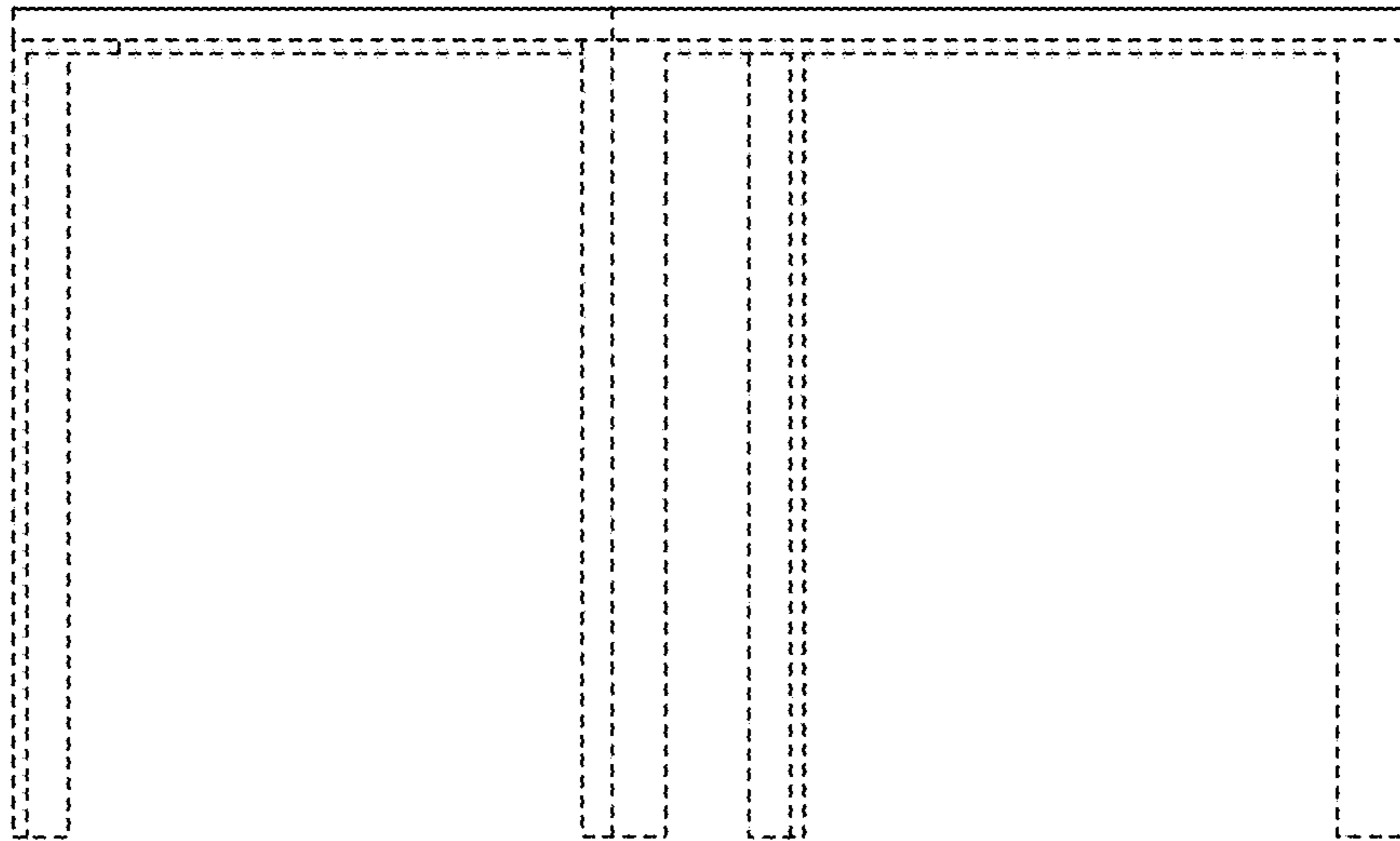

FIG. 9

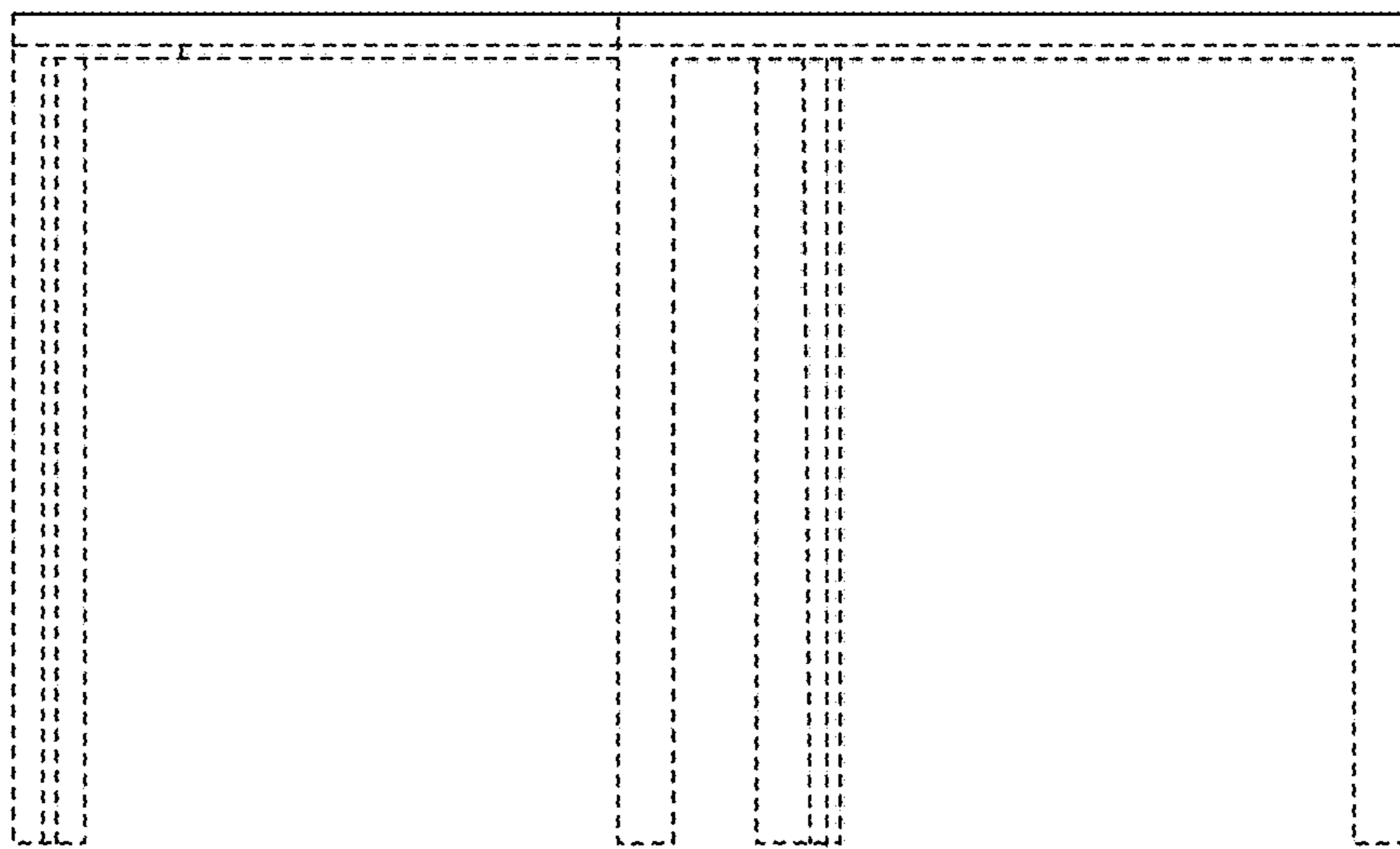

FIG. 10

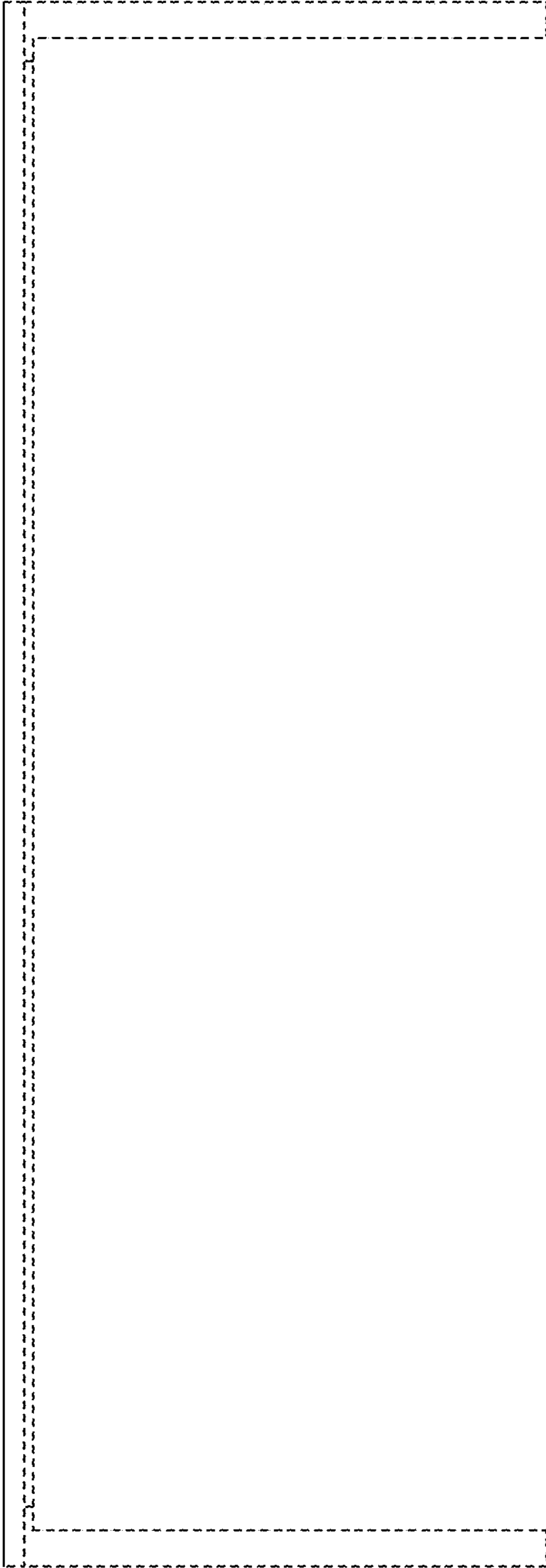

FIG. 11

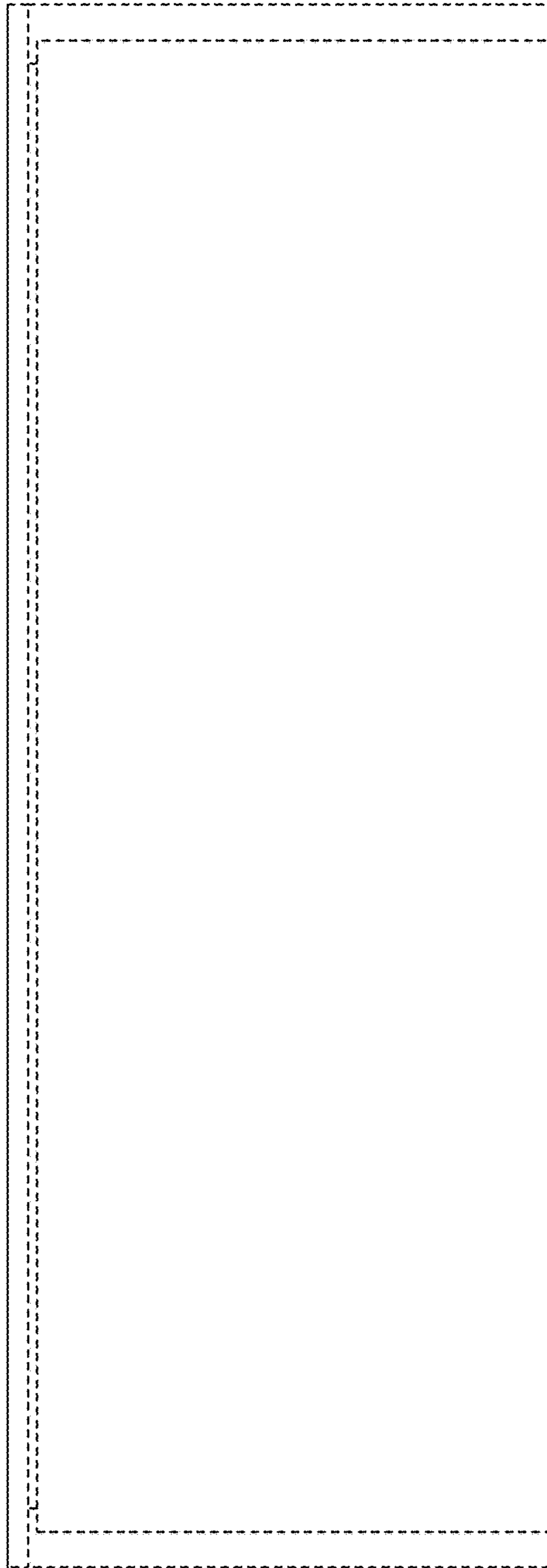

FIG. 12

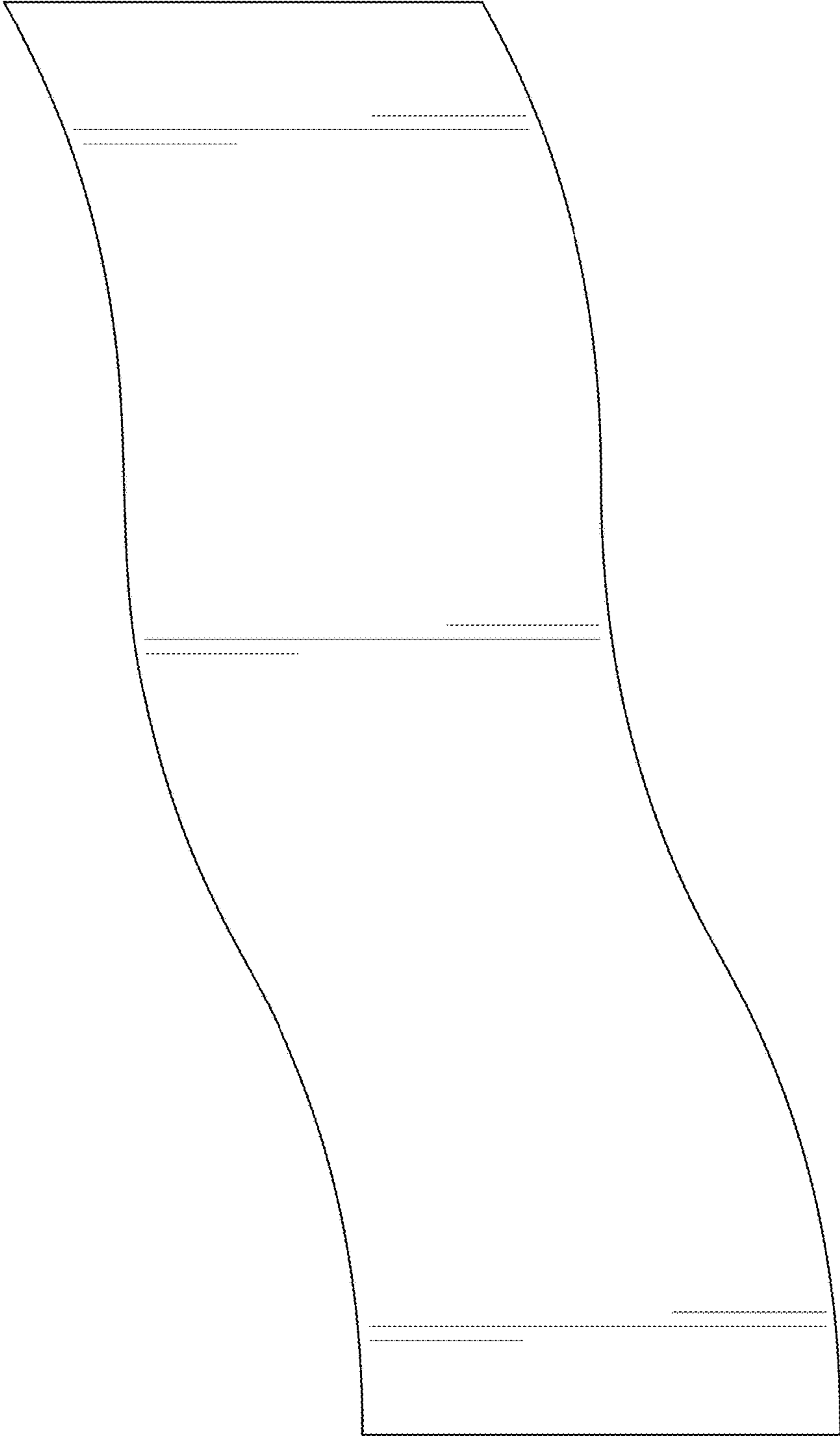

FIG. 13

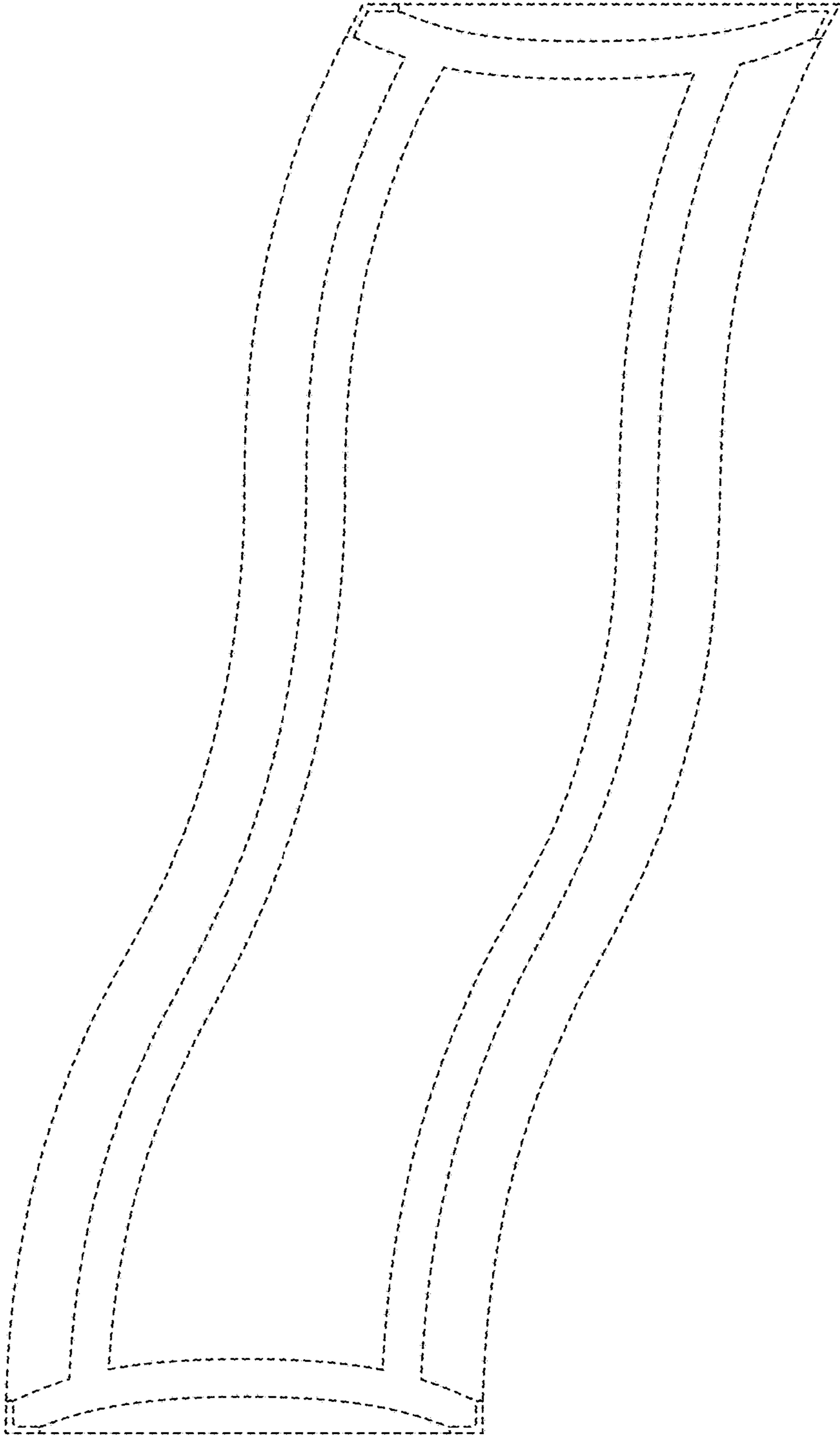

FIG. 14